

Video Cassette Recorder

Operating Instructions

SLV-SE100A1/A2



SLV-SE200V1/V2



SHOWVIEW®

SLV-SE250D/P



SHOWVIEW®

SLV-SX250D



SHOWVIEW®

SLV-SE300D1/D2



SHOWVIEW®

SLV-SE450D/P



SHOWVIEW®

SLV-SE480D



SHOWVIEW®

WARNING

To prevent fire or shock hazard, do not expose the unit to rain or moisture.

To avoid electrical shock, do not open the cabinet. Refer servicing to qualified personnel only.

Mains lead must only be changed at a qualified service shop.

Precautions

Safety

- This unit operates on 220 – 240 V AC, 50 Hz. Check that the unit's operating voltage is identical with your local power supply.
- If anything falls into the cabinet, unplug the unit and have it checked by qualified personnel before operating it any further.
- The unit is not disconnected from the mains as long as it is connected to the mains, even if the unit itself has been turned off.
- Unplug the unit from the wall outlet if you do not intend to use it for an extended period of time. To disconnect the cord, pull it out by the plug, never by the cord.

Installing

- Allow adequate air circulation to prevent internal heat buildup.
- Do not place the unit on surfaces (rugs, blankets, etc.) or near materials (curtains, draperies) that may block the ventilation slots.
- Do not install the unit near heat sources such as radiators or air ducts, or in a place subject to direct sunlight, excessive dust, mechanical vibration or shock.
- Do not install the unit in an inclined position. It is designed to be operated in a horizontal position only.
- Keep the unit and cassettes away from equipment with strong magnets, such as microwave ovens or large loudspeakers.
- Do not place heavy objects on the unit.
- If the unit is brought directly from a cold to a warm location, moisture may condense inside the VCR and cause damage to the video head and tape. When you first install the unit, or when you move it from a cold to a warm location, wait for about three hours before operating the unit.

Caution

Television programmes, films, video tapes and other materials may be copyrighted. Unauthorized recording of such material may be contrary to the provisions of the copyright laws. Also, use of this recorder with cable television transmission may require authorization from the cable television transmitter and/or programme owner.

Compatible colour systems

This VCR is designed to record using the PAL (B/G) colour system and play back using the PAL (B/G) and NTSC 4.43* colour systems. Recording of video sources based on other colour systems cannot be guaranteed.

SHOWVIEW is a registered trademark of Gemstar Development Corporation. The SHOWVIEW system is manufactured under license from Gemstar Development Corporation.

* SLV-SE100A1/A2 cannot play NTSC-recorded tapes.

Table of contents

Getting Started

- 4 Step 1 : Unpacking
- 5 Step 2 : Setting up the remote commander
- 9 Step 3 : Connecting the VCR
- 13 Step 4 : Tuning your TV to the VCR
- 16 Step 5 : Setting up the VCR with the Auto Set Up function
- 19 Step 6 : Setting the clock
- 24 Selecting a language
- 26 Presetting channels
- 30 Changing/disabling programme positions
- 36 Setting the PAY-TV/Canal Plus decoder
(not available on SLV-SE100A1/A2 and SE200V1/V2)

Basic Operations

- 41 Playing a tape
- 44 Recording TV programmes
- 48 Recording TV programmes using the Dial Timer
(SLV-SE300D1/D2, SE450D/P, and SE480D only)
- 53 Recording TV programmes using the ShowView system
(not available on SLV-SE100A1/A2)
- 57 Recording TV programmes using the timer

Additional Operations

- 61 Playing/searching at various speeds
- 63 Setting the recording duration time

- 64 Synchronized Recording
(SLV-SE300D1/D2 and SE480D only)
- 67 Checking/changing/cancelling timer settings
- 69 Searching using the Smart Search function
- 72 Adjusting the picture
- 74 Changing menu options
- 76 Editing with another VCR

Additional Information

- 79 Troubleshooting
- 83 Specifications
- 84 Index to parts and controls

Back Cover

Index

Step 1 : Unpacking

Check that you have received the following items with the VCR:

- Remote commander
- Aerial cable

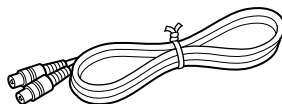
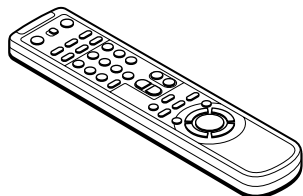

- R6 (size AA) batteries

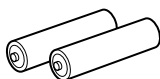

Check your model name

The instructions in this manual are for the 12 models: SLV-SE100A1, SE100A2, SE200V1, SE200V2, SE250D, SE250P, SX250D, SE300D1, SE300D2, SE450D, SE450P, and SE480D. Check your model number by looking at the rear panel of your VCR. SLV-SE480D is the model used for illustration purposes. Any difference in operation is clearly indicated in the text, for example, "SLV-SE450P only."

Step 2 : Setting up the remote commander

Inserting the batteries

Insert two R6 (size AA) batteries by matching the + and – on the batteries to the diagram inside the battery compartment.



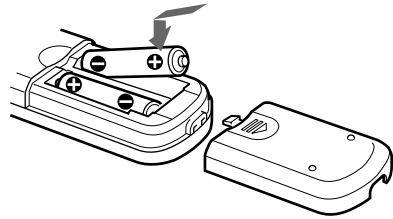

Insert the negative (–) end first, then push in and down until the positive (+) end clicks into position.

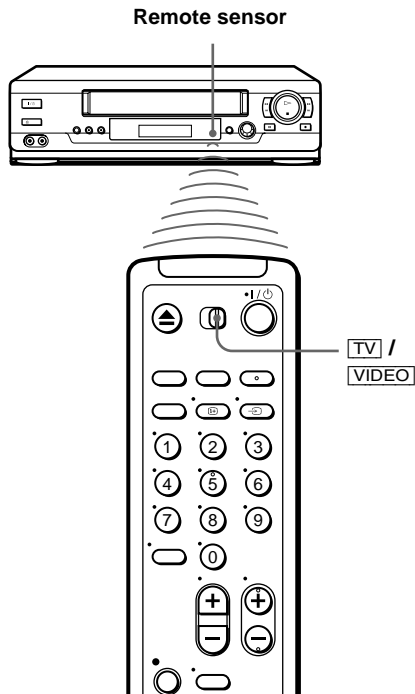

Using the remote commander

You can use this remote commander to operate this VCR and a Sony TV. Buttons on the remote commander marked with a dot (•) can be used to operate your Sony TV. If the TV does not have the  symbol near the remote sensor, this remote commander will not operate the TV.



To operate	Set  /  to
the VCR	 and point at the remote sensor at the VCR
a Sony TV	 and point at the remote sensor at the TV

continued

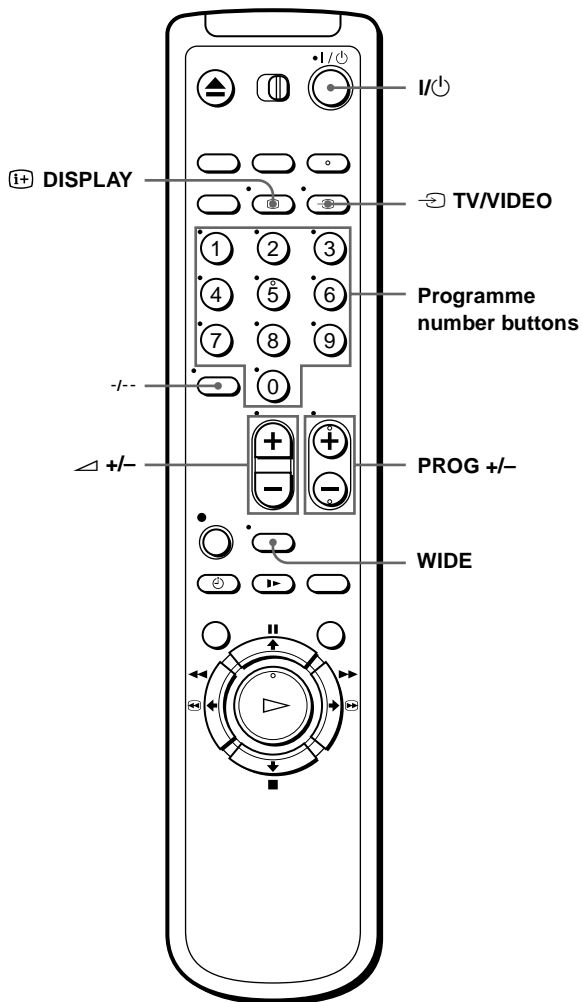

TV control buttons

To	Press
Set the TV to standby mode	I/Power
Select an input source: aerial in or line in	TV/VIDEO
Select the TV's programme position	Programme number buttons, -/-, PROG +/-
Adjust the volume of the TV	Volume +/-
Call up the on-screen display	DISPLAY

To	Press
Switch to/from wide mode of a Sony wide TV (For other manufactures' wide TVs, see "Controlling other TVs with the remote commander (SLV-SE300D1/D2 and SE480D only)" below.)	WIDE

Notes

- With normal use, the batteries should last about three to six months.
- If you do not use the remote commander for an extended period of time, remove the batteries to avoid possible damage from battery leakage.
- Do not use a new battery together with an old one.
- Do not use different types of batteries together.
- Some buttons may not work with certain Sony TVs.

Controlling other TVs with the remote commander (SLV-SE300D1/D2 and SE480D only)

The remote commander is preprogrammed to control non-Sony TVs. If your TV is listed in the following table, set the appropriate manufacturer's code number.

1 Set **[TV]** / **[VIDEO]** at the top of the remote commander to **[TV]**.

2 Hold down **I/⏻**, and enter your TV's code number using the programme number buttons. Then release **I/⏻**.

Now you can use the following TV control buttons to control your TV:

I/⏻, **⏪** TV/VIDEO, programme number buttons, **-/-** (ten's digit), **PROG +/-**, **⏪ +/-**, **WIDE***, **MENU***, **⏶/⏷/⏸/⏹***, and **OK***.

* These buttons may not work with all TVs.

continued

Code numbers of controllable TVs

If more than one code number is listed, try entering them one at a time until you find the one that works with your TV.

To switch to wide mode, see the footnotes below this table for the applicable code numbers.

Manufacturer	Code number
Sony	01* ¹ , 02
Akai	68
Ferguson	52
Grundig	10* ¹ , 11* ¹
Hitachi	24
JVC	33
Loewe	45
Mivar	09, 70
NEC	66
Nokia	15, 16, 69* ³

Manufacturer	Code number
Panasonic	17* ¹ , 49
Philips	06* ¹ , 07* ¹ , 08* ¹
Saba	12, 13
Samsung	22, 23
Sanyo	25
Sharp	29
Telefunken	36
Thomson	43* ²
Toshiba	38

*¹ Press WIDE to switch the wide picture mode on or off.

*² Press WIDE, then press \triangleleft +/- to select the wide picture mode you want.

*³ Press WIDE. The menu appears on the TV screen. Then, press $\uparrow/\downarrow/\leftarrow/\rightarrow$ to select the wide picture you want and press OK.

Tip

- To see if you set your TV's code number correctly, try turning your TV on and off with the I/⏻ switch.

Notes

- If you enter a new code number, the code number previously entered will be erased.
- If the TV uses a different remote control system from the one programmed to work with the VCR, you cannot control your TV with the remote commander.
- When you replace the batteries of the remote commander, the code number may change. Set the appropriate code number every time you replace the batteries.

Step 3 : Connecting the VCR

If your TV has a Scart (EURO-AV) connector, see page 10.

If your TV does not have a Scart (EURO-AV) connector

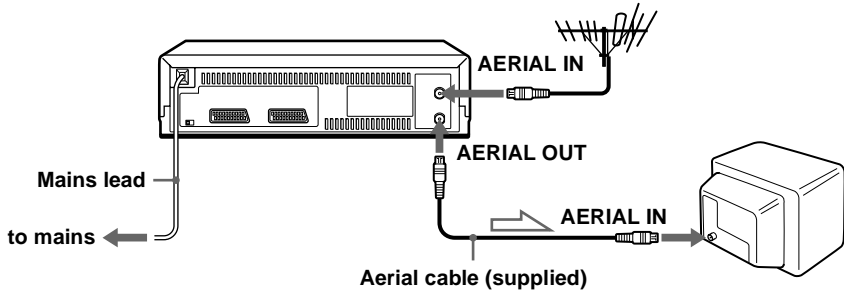

 : Signal flow

1

Disconnect the aerial cable from your TV and connect it to AERIAL IN on the rear panel of the VCR.

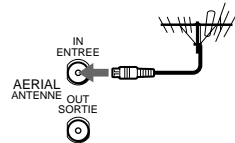

2

Connect AERIAL OUT of the VCR and the aerial input of your TV using the supplied aerial cable.



3

Connect the mains lead to the mains.

Note

- When you connect the VCR and your TV only with an aerial cable, you have to tune your TV to the VCR (see page 13).

continued

If your TV has a Scart (EURO-AV) connector

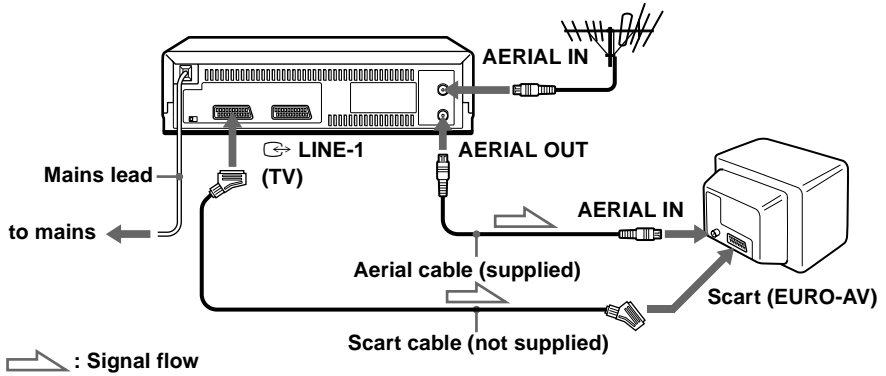

1

Disconnect the aerial cable from your TV and connect it to AERIAL IN on the rear panel of the VCR.

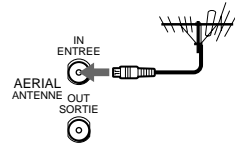

2

Connect AERIAL OUT of the VCR and the aerial input of your TV using the supplied aerial cable.



3

Connect LINE-1 (TV) on the VCR and the Scart (EURO-AV) connector on the TV with the optional Scart cable.

This connection improves picture and sound quality. Whenever you want to watch the VCR picture, press TV/VIDEO to display the VIDEO indicator in the display window.

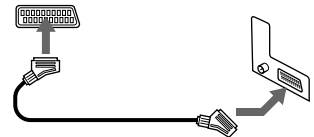

4

Connect the mains lead to the mains.

Note

- If the TV is connected to the LINE-1 (TV) connector, setting the RF channel to OFF is recommended. In the OFF position, only the signal from the aerial is output through the AERIAL OUT connector (see page 15).

About the SMARTLINK features (not available on SLV-SE100A1/A2)

If the connected TV complies with SMARTLINK, MEGALOGIC*¹, EASYLINK*², Q-Link*³, EURO VIEW LINK*⁴, or T-V LINK*⁵, this VCR automatically runs the SMARTLINK function after you complete the steps on the previous page (the SMARTLINK indicator appears in the VCR's display window when you turn on the TV). You can enjoy the following SMARTLINK features.



- **Preset Download**
You can download your TV tuner preset data to this VCR and tune the VCR according to that data in Auto Set Up. This greatly simplifies the Auto Set Up procedure. Be careful not to disconnect the cables or exit the Auto Set Up function during the procedure.
See “Setting up the VCR with the Auto Set Up function” on page 16.
- **TV Direct Rec**
You can easily record what you are watching on the TV. For details, see “Recording what you are watching on the TV (TV Direct Rec) (not available on SLV-SE100A1/A2)” on page 47.
- **One Touch Play**
With One Touch Play, you can start playback automatically without turning on the TV. For details, see “Starting playback automatically with one button (One Touch Play) (not available on SLV-SE100A1/A2)” on page 43.
- **One Touch Menu**
You can turn on the VCR and TV, set the TV to the video channel, and display the VCR's on-screen display automatically by pressing MENU on the remote commander.
- **One Touch Timer**
You can turn on the VCR and TV, set the TV to the video channel, and display the timer recording menu (the TIMER METHOD menu, the TIMER menu, or the SHOWVIEW menu) automatically by pressing  TIMER on the remote commander.
You can set which timer recording menu is displayed using TIMER OPTIONS in the OPTIONS-2 menu (see page 75).
- **Automatic Power Off**
You can have the VCR turn off automatically, if the VCR is not used after you turn off the TV.

*¹ “MEGALOGIC” is a registered trademark of Grundig Corporation.

*² “EASYLINK” is a trademark of Philips Corporation.

*³ “Q-Link” is a trademark of Panasonic Corporation.

*⁴ “EURO VIEW LINK” is a trademark of Toshiba Corporation.

*⁵ “T-V LINK” is a trademark of JVC Corporation.

Note

- Not all TVs respond to the functions above.

continued

Additional connection

To a satellite or digital tuner with Line Through (SLV-SE300D1/D2 and SE480D only)

Using the Line Through function, you can watch programmes from a satellite or digital tuner connected to this VCR on the TV even when the VCR is turned off. When you turn on the satellite or digital tuner, this VCR automatically sends the signal from the satellite or digital tuner to the TV without turning itself on.

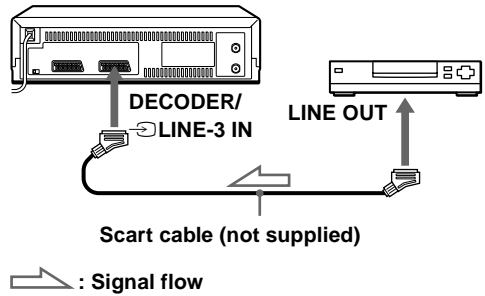

- 1 Connect the satellite or digital tuner to the DECODER/LINE-3 IN connector as shown above.
- 2 Set DECODER/LINE3 to LINE3 in the OPTIONS-2 menu.
- 3 Set POWER SAVE to OFF in the OPTIONS-2 menu.
- 4 Turn off the VCR.
To watch a programme, turn on the satellite or digital tuner and the TV.

Note

- You cannot watch programmes on the TV while recording unless you are recording a satellite or digital programme.

Step 4 : Tuning your TV to the VCR

If your TV has a Scart (EURO-AV) connector, see page 15.

If your TV does not have a Scart (EURO-AV) connector

Follow the steps below so that your TV will properly receive the video signals from your VCR.

I/⏻ ON/STANDBY RF CHANNEL

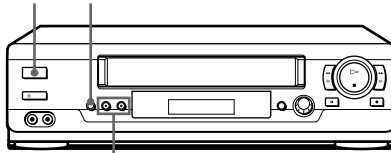

PROGRAM +/-

- 1** ON/STANDBY Press I/⏻ ON/STANDBY to turn on the VCR.



- 2** AUTO SET UP RF CHANNEL Press RF CHANNEL on the VCR lightly.



The factory-preset RF channel appears in the display window.
The VCR signal is output through this channel to the TV.

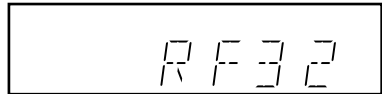

- 3** Turn on your TV and select a programme position for the VCR picture.
This programme position will now be referred to as the video channel.

- 4** Tune the TV to the same channel shown in the VCR display window so that the picture on the right appears clearly on the TV screen.

Refer to your TV manual for TV tuning instructions.

If the picture does not appear clearly, see "To obtain a clear picture from the VCR" below.

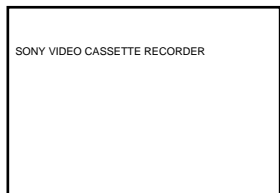

continued

5AUTO SET UP
RF CHANNEL

Press RF CHANNEL.



You have now tuned your TV to the VCR. Whenever you want to play a tape, set the TV to the video channel.

To check to see if the TV tuning is correct

Set the TV to the video channel and press PROGRAM +/- on the VCR. If the TV screen changes to a different programme each time you press PROGRAM +/-, the TV tuning is correct.

To obtain a clear picture from the VCR

If the screen does not appear clearly in step 4 above, press PROGRAM +/- so that another RF channel appears. Then tune the TV to the new RF channel so that a clear picture appears.

If your TV has a Scart (EURO-AV) connector

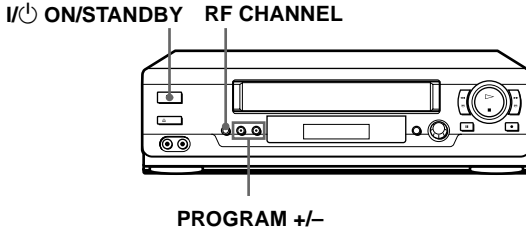

1 ON/STANDBY Press I/ON STANDBY to turn on the VCR.



2 AUTO SET UP RF CHANNEL Press RF CHANNEL on the VCR lightly.
The factory-preset RF channel appears in the display window.
The VCR signal is output through this channel to the TV.

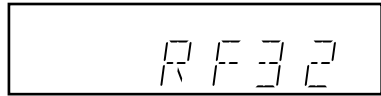

3 - PROGRAM + TRACKING Press PROGRAM +/- to set the RF channel to OFF, and press RF CHANNEL again.



AUTO SET UP RF CHANNEL



RF channel set up is complete.

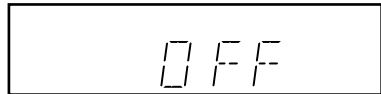

Step 5 : Setting up the VCR with the Auto Set Up function

Before using the VCR for the first time, set up the VCR using the Auto Set Up function. With this function, you can set the language for the on-screen display, TV channels, guide channels for the ShowView system*1, and VCR clock*2 automatically.

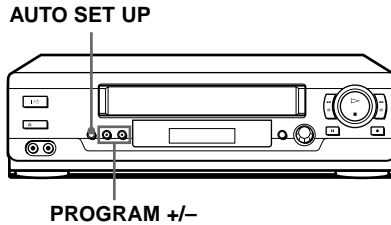

-
- 1** **AUTO SET UP** Hold down AUTO SET UP on the VCR for more than three seconds.
RF CHANNEL The VCR automatically turns on, and the country abbreviation appears in the display window.

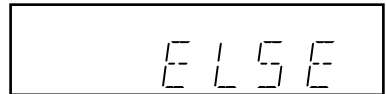

-
- 2** **- PROGRAM +** Press PROGRAM +/- to select the abbreviation of your country from the table on page 17.
TRACKING For some countries, there is a selection of languages to choose from. If your country does not appear, select ELSE.



3

AUTO SET UP
RF CHANNEL



Press AUTO SET UP lightly.

The VCR starts searching for all of the receivable channels and presets them (in the appropriate order for your local area*2).

If you want to change the order of the channels or disable unwanted programme positions, see “Changing/disabling programme positions” on page 30.



If you use the SMARTLINK connection (not available on SLV-SE100A1/A2), the Preset Download function starts and the SMARTLINK indicator flashes in the display window during download.

After the search or download is complete, the current time appears in the display window for any stations that transmit a time signal (not available on SLV-SE100A1/A2, SE250P, and SE450P).

The abbreviations of the countries and languages are as follows:

Abbreviation	Country	Language
A	Austria	German
B-D	Belgium	German
B-F	Belgium	French
B-N	Belgium	Dutch
CH-D	Switzerland	German
CH-F	Switzerland	French
CH-I	Switzerland	Italian
D	Germany	German
DK	Denmark	Danish
E	Spain	Spanish
GR	Greece	Greek

Abbreviation	Country	Language
I	Italy	Italian
L-D	Luxembourg	German
L-F	Luxembourg	French
N	Norway	Danish
NL	Netherlands	Dutch
P	Portugal	Portuguese
S	Sweden	Swedish
SF	Finland	Finnish
ELSE	Other countries	English

continued

To cancel the Auto Set Up function

Press AUTO SET UP.

Tip

- If you want to change the language for the on-screen display from the one preset in the Auto Set Up function, see page 24.

Notes

- If you stop the Auto Set Up function during step 3, you must repeat set up from step 1.
- Whenever you operate the Auto Set Up function, some of the settings (ShowView*¹, timer, etc.) will be reset. If this happens, you have to set them again.

*¹ not available on SLV-SE100A1/A2

*² not available on SLV-SE100A1/A2, SE250P, and SE450P

Step 6 : Setting the clock

You must set the time and date on the VCR to use the timer features properly.

The Auto Clock Set function (not available on SLV-SE100A1/A2, SE250P, and SE450P) works only if a station in your area is broadcasting a time signal. If the Auto Set Up function did not set the clock correctly for your local area, try another station for the Auto Clock Set function.

Setting the clock manually

Before you start...

- Turn on the VCR and the TV.
- Set the TV to the video channel.

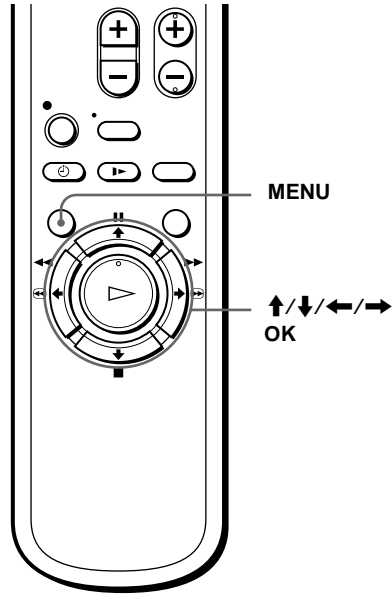

1

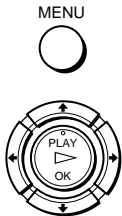

Press MENU, then press \uparrow/\downarrow to highlight SETTINGS and press OK.

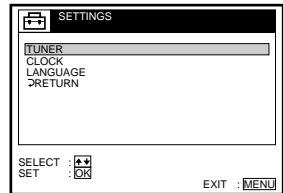

2



Press \uparrow/\downarrow to highlight CLOCK, then press OK.

For SLV-SE100A1/A2, SE250P, and SE450P, only the clock setting menu appears. Skip the next step and go to step 4.

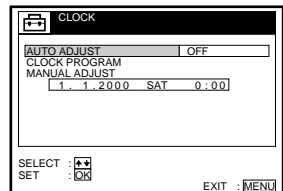

continued

3



Press **↑/↓** to highlight MANUAL ADJUST, then press OK.

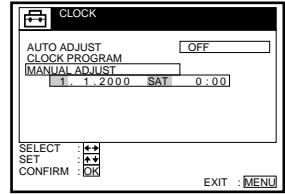

4



Press **↑/↓** to set the day.

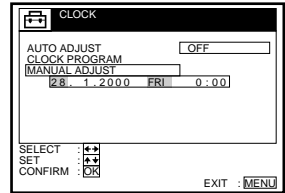

5



Press **→** to highlight the month and set the month pressing **↑/↓**.

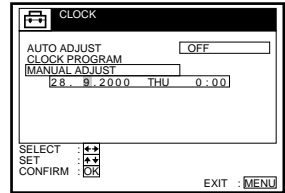

6



Set the year, hour, and minutes in sequence, pressing **→** to highlight the item to be set, and press **↑/↓** to select the digits.

The day of the week is set automatically.

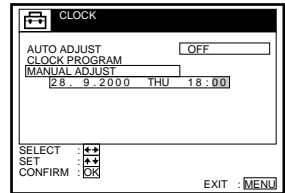

7



Press OK to start the clock.

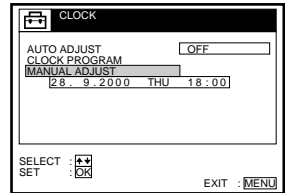

8

MENU



Press MENU to exit the menu.

Tips

- To change the digits while setting, press ← to return to the item to be changed, and select the digits by pressing ↑/↓.
- If you want to return to the previous menu, highlight RETURN and press OK.

Note

- The menu disappears automatically if you don't proceed for more than a few minutes.

Changing the station for the Auto Clock Set function (not available on SLV-SE100A1/A2, SE250P, and SE450P)

Before you start...

- Turn on the VCR and the TV.
- Set the TV to the video channel.

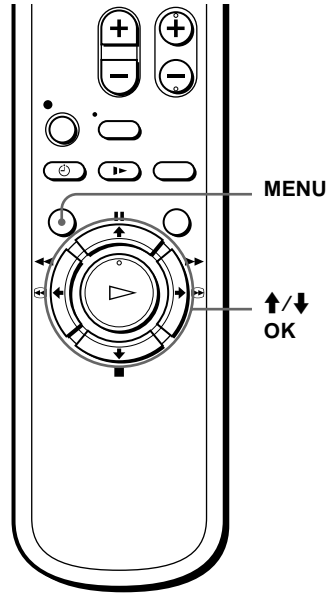

1 Press MENU, then press ↑/↓ to highlight SETTINGS and press OK.

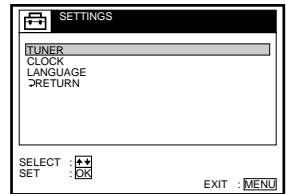
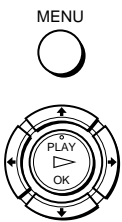

2 Press ↑/↓ to highlight CLOCK, then press OK.



AUTO ADJUST is highlighted.

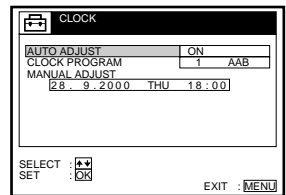

3 Press OK.

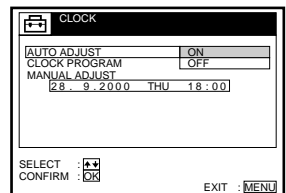

4



Press \uparrow/\downarrow to highlight ON, then press OK.

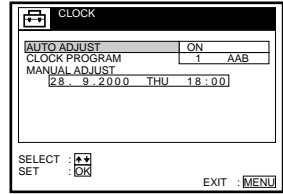

5



Press \downarrow to highlight CLOCK PROGRAM, then press OK.

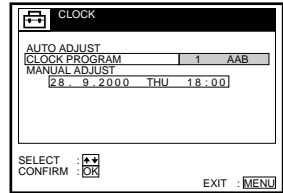

6



Press \uparrow/\downarrow repeatedly until the programme position of the station that carries a time signal appears.

If the VCR does not receive a time signal from any station, AUTO ADJUST returns to OFF automatically.

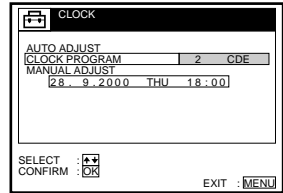

7

MENU



Press MENU to exit the menu.

Tips

- If you set AUTO ADJUST to ON, the Auto Clock Set function is activated whenever the VCR is turned off. The time is adjusted automatically by making reference to the time signal from the station whose programme position is displayed in the "CLOCK PROGRAM" row. If you do not need the Auto Clock Set, select OFF.
- If you want to return to the previous menu, highlight RETURN and press OK.

Note

- The menu disappears automatically if you don't proceed for more than a few minutes.

Selecting a language

You can change the on-screen display language from the one you selected with the Auto Set Up function.

Before you start...

- Turn on the VCR and the TV.
- Set the TV to the video channel.

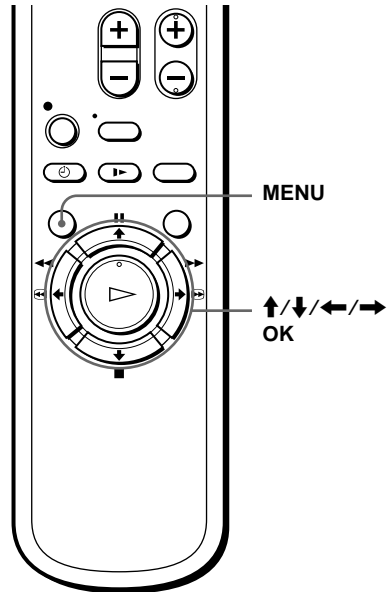

- 1** Press MENU, then press **↑/↓** to highlight SETTINGS and press OK.

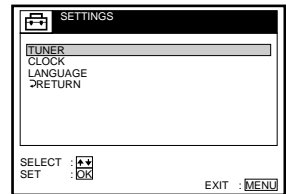
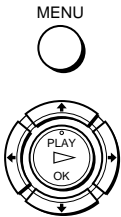

- 2** Press **↑/↓** to highlight LANGUAGE, then press OK.

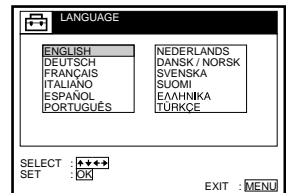

3

Press **↑/↓/←/→** to highlight the desired language, then press OK.

4

MENU



Press MENU to exit the menu.

Tip

- If you want to return to the previous menu, highlight RETURN and press OK.

Note

- The menu disappears automatically if you don't proceed for more than a few minutes.

Presetting channels

If some channels could not be preset using the Auto Set Up function, you can preset them manually.

Before you start...

- Turn on the VCR and the TV.
- Set the TV to the video channel.

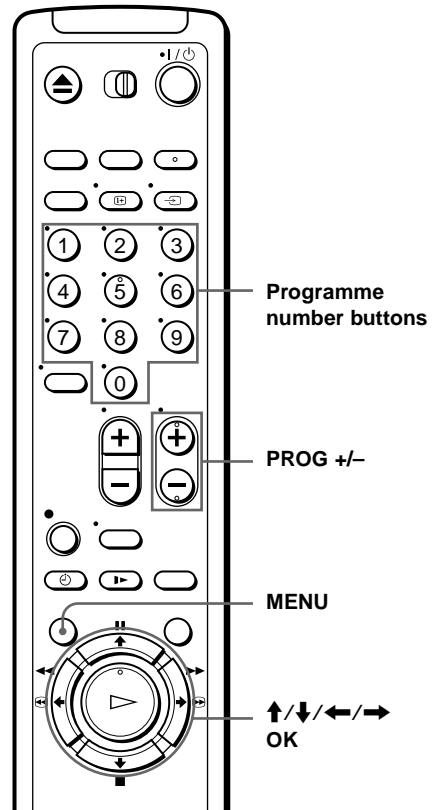

1

MENU



Press MENU, then press **↑/↓** to highlight SETTINGS and press OK.

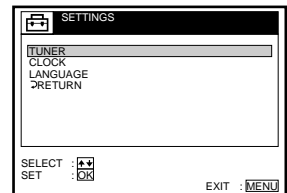

2



Press \uparrow/\downarrow to highlight TUNER, then press OK.

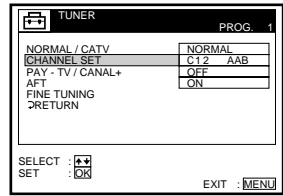

3



Press \uparrow/\downarrow to highlight NORMAL/CATV, then press OK.

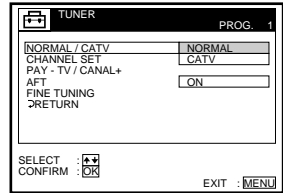

4



Press \uparrow/\downarrow to highlight NORMAL, then press OK.

To preset CATV (Cable Television) channels, select CATV.

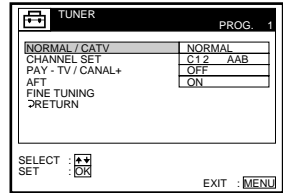

5



Press PROG +/- to select the programme position.

Selected programme position

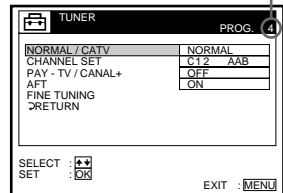

6



Press \uparrow/\downarrow to highlight CHANNEL SET, then press OK.

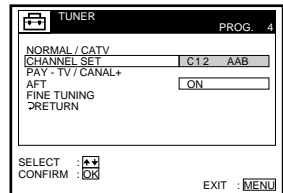

continued

7

Press **↑/↓** repeatedly until the channel you want is displayed.

The channels appear in the following order:

- VHF E2 - E12
- VHF Italian channel A - H
- UHF E21 - E69
- CATV S1 - S20
- HYPER S21 - S41
- CATV S01 - S05

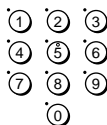

If you know the number of the channel you want, press the programme number buttons. For example, for channel 5, first press “0” and then press “5.”

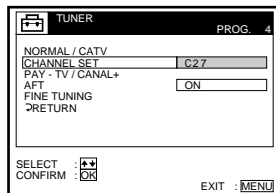

8

To preset another programme position, repeat steps 5 through 7.

9

MENU



Press **MENU** to exit the menu.

If the picture is not clear

Normally, the Auto Fine Tuning (AFT) function automatically tunes in channels clearly. However, if the picture is not clear, you may also use the manual tuning function.

- 1 Press PROG +/- or the programme number buttons to select the programme position for which you cannot obtain a clear picture.
- 2 Press MENU, then select SETTINGS and press OK.
- 3 Select TUNER, then press OK.
- 4 Select FINE TUNING, then press OK.

The fine tuning meter appears.

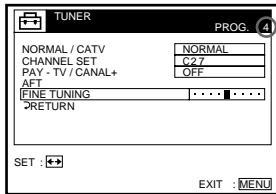

Selected programme position

- 5 Press ←/→ to get a clearer picture, then press MENU to exit the menu.
Note that the AFT (Auto Fine Tuning) setting switches to OFF.

Tip

- If you want to return to the previous menu, highlight RETURN and press OK.

Notes

- The menu disappears automatically if you don't proceed for more than a few minutes.
- When adjusting FINE TUNING, the menu may become difficult to read due to interference from the picture being received.

Changing/disabling programme positions

After setting the channels, you can change the programme positions as you like. If any programme positions are unused or contain unwanted channels, you can disable them.

You can also change the station names (not available on SLV-SE100A1/A2). If the station names are not displayed, you can enter them manually.

Changing programme positions

Before you start...

- Turn on the VCR and the TV.
- Set the TV to the video channel.

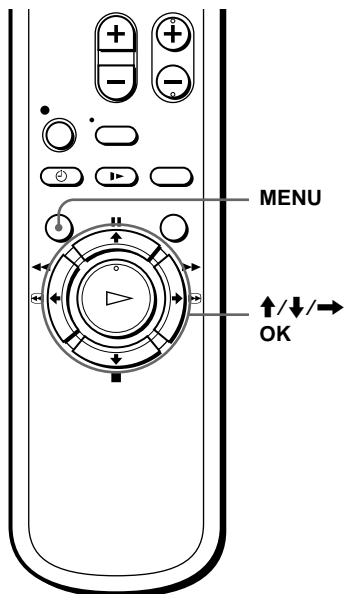

1

MENU



Press MENU, then press **↑/↓** to highlight LISTS and press OK.

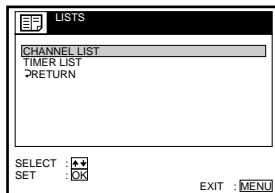

2

Press **↑/↓** to highlight CHANNEL LIST, then press OK.

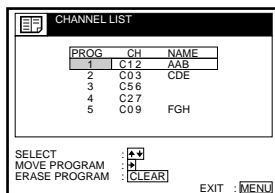

3



Press \uparrow/\downarrow to highlight the row which you want to change the programme position, then press \rightarrow .

To display other pages for programme positions 6 to 60, press \uparrow/\downarrow repeatedly.

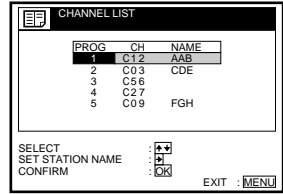

4



Press \uparrow/\downarrow until the selected channel row moves to the desired programme position.

The selected channel is inserted at the new programme position and the intermediate channels are displaced to fill the gap.

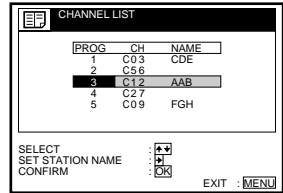

5



Press OK to confirm the setting.

6

To change the programme position of another station, repeat steps 3 through 5.

7

MENU



Press MENU to exit the menu.

Tip

- If you want to return to the previous menu, highlight RETURN and press OK.

Note

- The menu disappears automatically if you don't proceed for more than a few minutes.

continued

Disabling unwanted programme positions

After presetting channels, you can disable unused programme positions. The disabled positions will be skipped later when you press the PROG +/- buttons.

Before you start...

- Turn on the VCR and the TV.
- Set the TV to the video channel.

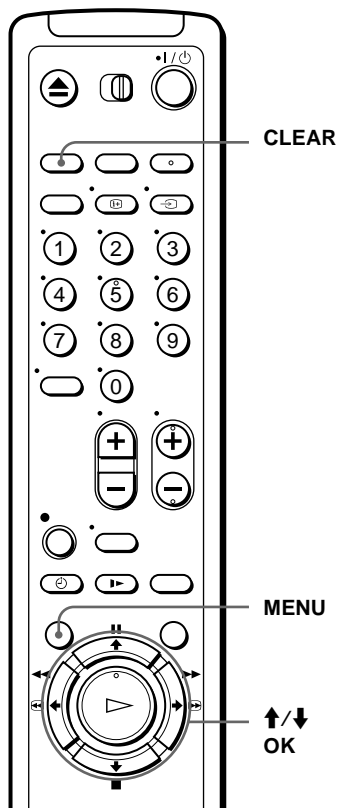

1

MENU



Press MENU, then press **↑/↓** to highlight LISTS, and press OK.

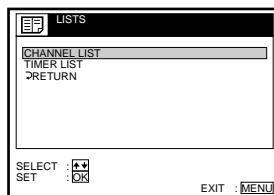

2



Press **↑/↓** to highlight CHANNEL LIST, then press OK.

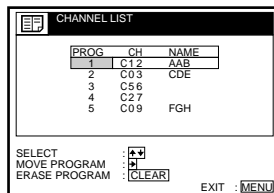

3



Press **↑/↓** to highlight the row which you want to disable.

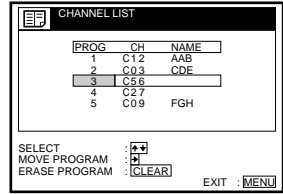

4



Press **CLEAR**.

The selected row will be cleared as shown on the right.

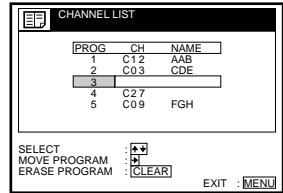

5

Repeat steps 3 and 4 for any other programme positions you want to disable.

6



Press **MENU** to exit the menu.

Tip

- If you want to return to the previous menu, highlight RETURN and press OK.

Notes

- The menu disappears automatically if you don't proceed for more than a few minutes.
- Be sure to select the programme position you want to disable correctly. If you disable a programme position by mistake, you need to reset that channel manually.

continued

Changing the station names (not available on SLV-SE100A1/ A2)

You can change or enter the station names (up to 5 characters). The VCR must receive channel information (for instance, SMARTLINK information) for station names to appear automatically.

Before you start...

- Turn on the VCR and the TV.
- Set the TV to the video channel.

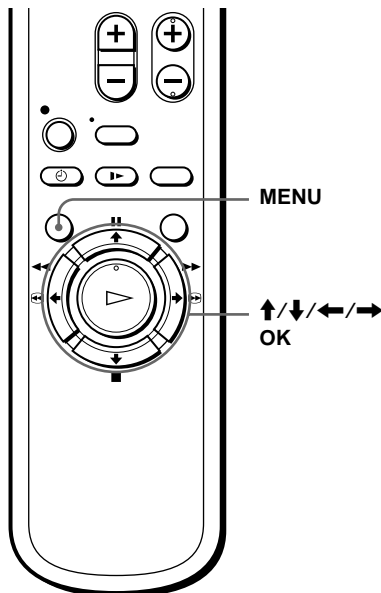

- 1** Press MENU, then press **↑/↓** to highlight LISTS and press OK.

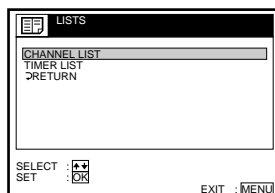
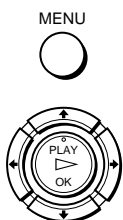

- 2** Press **↑/↓** to highlight CHANNEL LIST, then press OK.

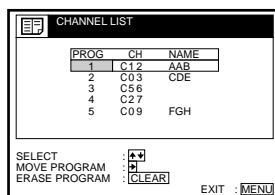

- 3** Press **↑/↓** to highlight the row which you want to change or enter the station name, then press **→**.



To display other pages for programme positions 6 to 60, press **↑/↓** repeatedly.

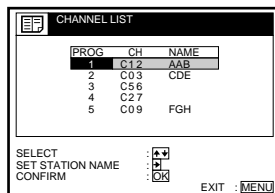

4



Press →.

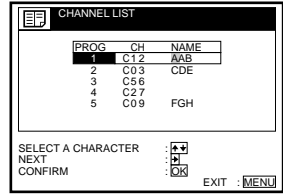

5



Enter the station name.

1 Press ↑/↓ to select a character.

Each time you press ↑, the character changes as shown below.

A → B → ... → Z → a → b → ... → z
 → 0 → 1 → ... → 9 → (symbols) →
 (blank space) → A

2 Press → to set the next character.

The next space is highlighted.

To correct a character, press ←/→ until the character you want to correct is highlighted, then reset it.

You can set up to 5 characters for the station name.

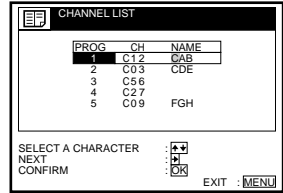

6



Press OK to confirm the new name.

7

MENU



Press MENU to exit the menu.

Tip

- If you want to return to the previous menu, highlight RETURN and press OK.

Notes

- The menu disappears automatically if you don't proceed for more than a few minutes.
- If you enter a symbol in step 5, it will appear as a blank space in the display window.

Setting the PAY-TV/Canal Plus decoder (not available on SLV-SE100A1/A2 and SE200V1/V2)

You can watch or record PAY-TV/Canal Plus programmes if you connect a decoder (not supplied) to the VCR.

Connecting a decoder

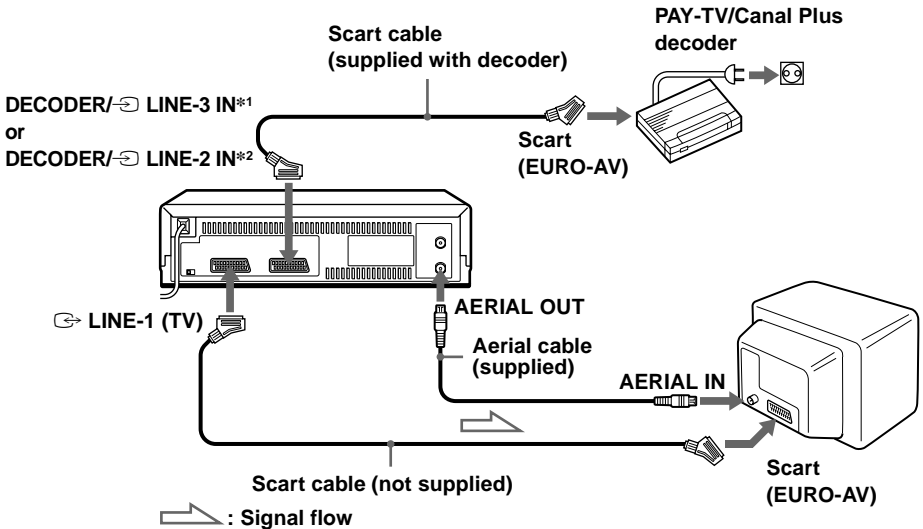

Setting PAY-TV/Canal Plus channels

To watch or record PAY-TV/Canal Plus programmes, set your VCR to receive the channels using the on-screen display.

In order to set the channels correctly, be sure to follow all of the steps below.

Before you start...

- Turn on the VCR, the TV, and the decoder.
- Set the TV to the video channel.

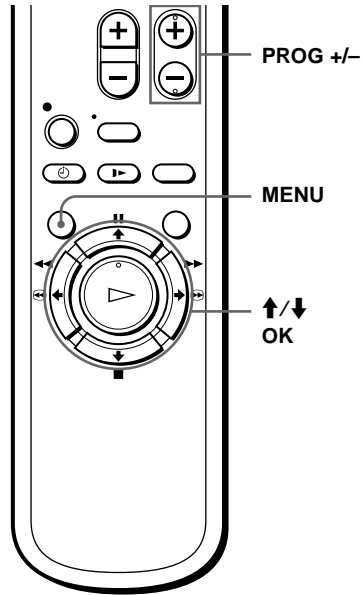

1

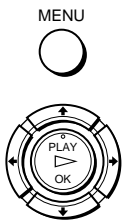

Press MENU, then press **↑/↓** to highlight **OPTIONS** and press OK.

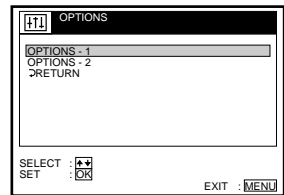

2



Press **↑/↓** to highlight **OPTIONS-2**, then press OK.

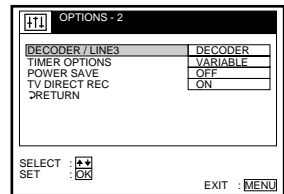

3



Press **↑/↓** to highlight **DECODER / LINE3*1** (or **DECODER / LINE2*2**), then press OK.

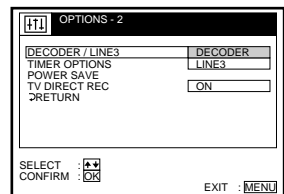

continued

4



Press **↑/↓** to highlight DECODER, then press OK.

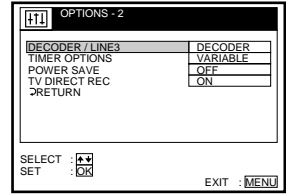

OPTIONS - 2	
DECODER / LINE3	DECODER
TIMER OPTIONS	VARIABLE
POWER SAVE	OFF
TV DIRECT REC	ON
RETURN	

SELECT : **↑/↓**
SET : **OK**
EXIT : MENU

5



Press MENU to exit the menu.
The menu disappears from the TV screen.

6



Press MENU again. Then press **↑/↓** to highlight SETTINGS and press OK.

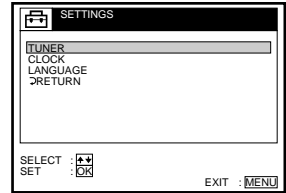

SETTINGS	
TUNER	
CLOCK	
LANGUAGE	
RETURN	

SELECT : **↑/↓**
SET : **OK**
EXIT : MENU

7



Press **↑/↓** to highlight TUNER, then press OK.

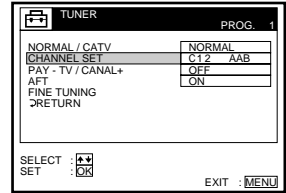

TUNER		PROG. 1
NORMAL / CATV		NORMAL
CHANNEL SET		CT 2 AAB
PAY - TV / CANAL+		OFF
AFT		ON
FINE TUNING		
RETURN		

SELECT : **↑/↓**
SET : **OK**
EXIT : MENU

8



Press **↑/↓** to highlight NORMAL/CATV, then press OK.

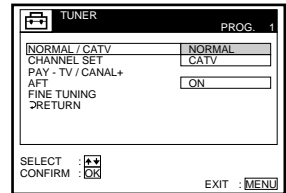

TUNER		PROG. 1
NORMAL / CATV		NORMAL
CHANNEL SET		CATV
PAY - TV / CANAL+		ON
AFT		
FINE TUNING		
RETURN		

SELECT : **↑/↓**
CONFIRM : **OK**
EXIT : MENU

9



Press **↑/↓** to highlight **NORMAL**, then press **OK**.

To preset **CATV** (Cable Television) channels, select **CATV**.

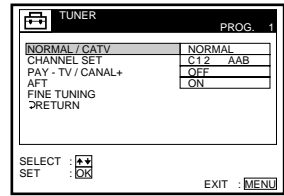

10

•PROG



Press **PROG +/-** to select the desired programme position.

Selected programme position

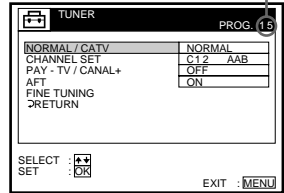

11



Press **↑/↓** to highlight **CHANNEL SET**, then press **OK**.

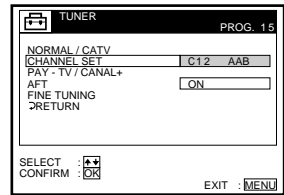

12



Press **↑/↓** to select the **PAY-TV/Canal Plus** channels, then press **OK**.

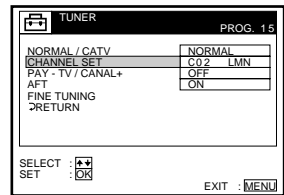

13



Press **↑/↓** to highlight **PAY-TV/CANAL+**, then press **OK**.

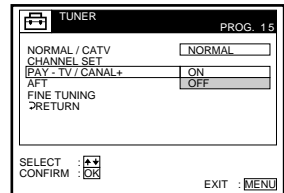

continued

14

Press **↑/↓** to highlight ON, then press OK.

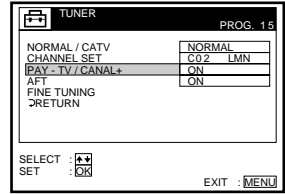

15

MENU



Press MENU to exit the menu.

Tip

- If you want to return to the previous menu, highlight RETURN and press OK.

Notes

- The menu disappears automatically if you don't proceed for more than a few minutes.
- To superimpose subtitles while watching PAY-TV/Canal Plus programmes, make both decoder-VCR and VCR-TV connections using 21-pin Scart cables that are compatible with the RGB signals. You cannot record subtitles on the VCR.
- When you watch PAY-TV/Canal Plus programmes through the RFU input of the TV, press **↵** TV/VIDEO so that the VIDEO indicator appears in the display window.

*1 SLV-SE300D1/D2 and SE480D only

*2 SLV-SE250D/P, SX250D, and SE450D/P only

Playing a tape

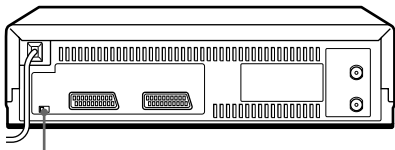

NTSC PB

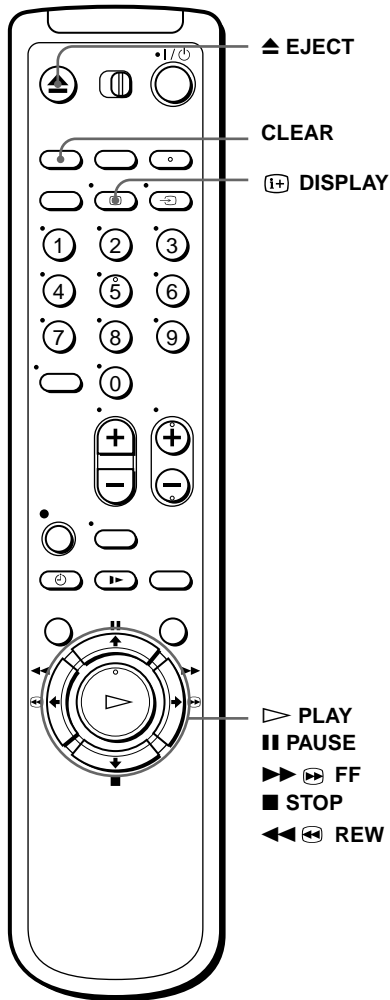

1 Turn on your TV and set it to the video channel.

2 Insert a tape.
The VCR turns on and starts playing automatically if you insert a tape with its safety tab removed.

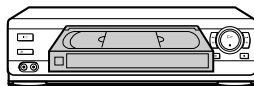

continued

3



Press PLAY.

When the tape reaches the end, it will rewind automatically.

Additional tasks

To	Press
Stop play	■ STOP
Pause play	PAUSE
Resume play after pause	PAUSE or PLAY
Fast-forward the tape	FF during stop
Rewind the tape	REW during stop
Eject the tape	EJECT

To play an NTSC-recorded tape (not available on SLV-SE100A1/A2)

Set NTSC PB at the rear of the VCR according to the colour system of your TV.

When your TV is	Set NTSC PB to
PAL only	ON PAL TV
PAL and NTSC	NTSC 4.43

To use the time counter

Press CLEAR at the point on the tape that you want to find later. The counter in the display window resets to “0:00:00.” Search for the point afterwards by referring to the counter.

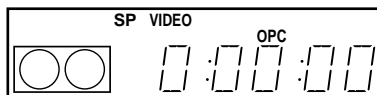

To display the counter on the TV screen, press DISPLAY.

Notes

- The counter resets to “0:00:00” whenever a tape is reinserted.
- The counter stops counting when it comes to a portion with no recording.
- The time counter does not appear on the TV screen when using an NTSC*¹-recorded tape.
- Depending on your TV, the following may occur while playing an NTSC*¹-recorded tape:
 - The picture becomes black and white.
 - The picture shakes.
 - No picture appears on the TV screen.
 - Black streaks appear horizontally on the TV screen.
 - The colour density increases or decreases.
- While setting the menu on the TV screen, buttons for playback on the remote commander do not function.
- Tapes recorded in the LP and EP mode cannot be played back on this VCR.*²

*¹ SLV-SE100A1/A2 cannot play NTSC-recorded tapes.

*² SLV-SE100A1/A2 and SE200V1/V2 only

Starting playback automatically with one button (One Touch Play) (not available on SLV-SE100A1/A2)

If you use the SMARTLINK connection, you can turn on the VCR and the TV, set the TV to the video channel, and start playback automatically with one button.

1 Insert a tape.

The VCR automatically turns on.

If you insert a tape with its safety tab removed, the TV turns on and switches to the video channel. Playback starts automatically.

2 Press ▷ PLAY.

The TV turns on and switches to the video channel automatically. Playback starts.

Tip

- When there already is a tape in the VCR, the VCR and the TV turn on, the TV is set to the video channel, and playback starts automatically in one sequence when you press ▷ PLAY.

Note

- When you use the One Touch Play function, leave the TV on or in the standby mode.

Recording TV programmes

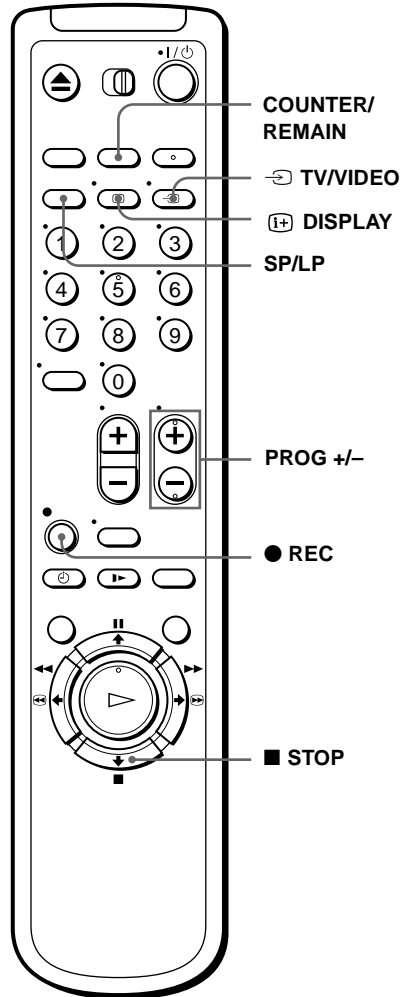

-
- 1** Turn on your TV and set it to the video channel.
To record from a decoder, turn it on.

 - 2** Insert a tape with its safety tab in place.

3

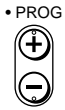

Press PROG +/- to select the programme position or station name*¹ you want to record.

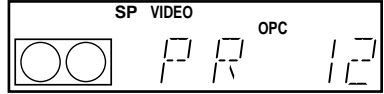

4



Press SP/LP to select the tape speed, SP or LP.*²

LP (Long Play) provides recording time twice as long as SP. However, SP (Standard Play) produces better picture and audio quality.



5



Press ● REC to start recording.

The recording indicator lights up red in the display window.

Recording indicator



To stop recording

Press ■ STOP.

To check the remaining time

Press (+) DISPLAY. With the display on, press COUNTER/REMAIN to check the remaining time. Each time you press COUNTER/REMAIN, the time counter and the remaining time appear alternately. The ⌚ indicator indicates the remaining time.



Time counter

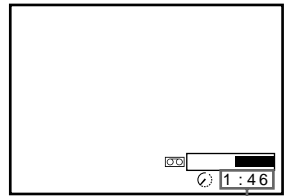

Remaining time

In order to get an accurate remaining time indication, be sure TAPE LENGTH in the OPTIONS-1 menu is set according to the tape type you use (see page 74).

To watch another TV programme while recording

1 Press ⇐ TV/VIDEO to turn off the VIDEO indicator in the display window.

2 Select another programme position on the TV.

continued

To save a recording

To prevent accidental erasure, break off the safety tab as illustrated. To record on the same tape again, cover the tab hole with adhesive tape.

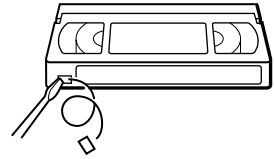

Safety tab

Tips

- To select a programme position, you can use the programme number buttons on the remote commander. For two-digit numbers, press the *-/-* (ten's digit) button followed by the programme number buttons.
- If you connect additional equipment to a LINE connector or jack, you can select the input signal using the INPUT SELECT or PROG +/- buttons.
- The **i+** DISPLAY information appears on the TV screen indicating information about the tape, but the information won't be recorded on the tape.
- If you don't want to watch TV while recording, you can turn off the TV. When using a decoder, make sure to leave it on.

Notes

- The **i+** DISPLAY information does not appear during still (pause) mode or slow-motion playback.
- The **i+** DISPLAY information will not appear while playing an NTSC*³-recorded tape.
- If a tape has portions recorded in both PAL and NTSC*³ systems, the time counter reading will not be correct. This discrepancy is due to the difference between the counting cycles of the two video systems.
- You cannot watch a PAY-TV/Canal Plus programme while recording another PAY-TV/Canal Plus programme.*²
- When you insert a non-standard commercially available tape, the remaining time may not be correct.
- The remaining time is intended for rough measurement only.
- About 30 seconds after the tape begins playback, the tape remaining time will be displayed.
- The station name*¹ may not appear if the VCR does not receive station name information signals.

*¹ not available on SLV-SE100A1/A2

*² not available on SLV-SE100A1/A2 and SE200V1/V2

*³ SLV-SE100A1/A2 cannot play NTSC-recorded tapes.

Recording what you are watching on the TV (TV Direct Rec) (not available on SLV-SE100A1/A2)

If you use the SMARTLINK connection, you can easily record what you are watching on the TV (other than tapes being played on the VCR).

- 1** Insert a tape with its safety tab in place.
- 2** Press ● REC while you are watching a TV programme or external source.
The VCR automatically turns on, then the TV indicator lights up and the VCR starts recording what you are watching on the TV.

Tips

- The TV indicator appears in the display window after you press ● REC in some situations such as:
 - when you are watching a source connected to the TV's line input, or
 - when the TV tuner preset data for the programme position is different from the data in the VCR tuner preset.
- If there is a tape with its safety tab in place in the VCR, the VCR automatically turns on and starts recording what you are watching on the TV when you press ● REC.
- You can turn the TV Direct Rec function ON and OFF in the OPTIONS-2 menu (see page 75).

Notes

- You cannot record what you are watching using this method when the VCR is in the following modes; pause, timer standby, tuner preset, Auto Set Up, and recording.
- When the TV indicator is lit in the display window, do not turn off the TV nor change the TV programme position. When the TV indicator is not lit, the VCR continues recording the programme even if you change the TV programme position on the TV.

Recording TV programmes using the Dial Timer

(SLV-SE300D1/D2, SE450D/P, and SE480D only)

The Dial Timer function allows you to make timer recordings of programmes without turning on your TV. Set the recording timer to record up to eight programmes, including settings made with other timer methods, that will be broadcast within the next month. The recording start time and recording stop time can be set at one minute intervals.

Before you start...

- Insert a tape with its safety tab in place.
Make sure the tape is longer than the total recording time.
- To record from a decoder, turn it on.

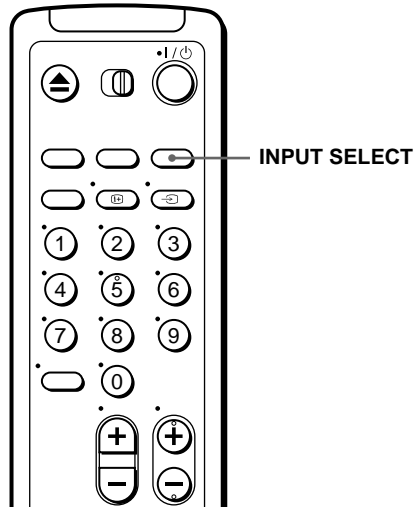
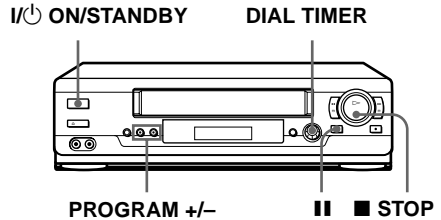

1

DIAL TIMER



Press DIAL TIMER.

“DATE” and “TODAY” appear alternately in the display window.

If the date and time are not set, “DAY” will appear. See step 2 in the following section, “To set the clock” to set the date and time.

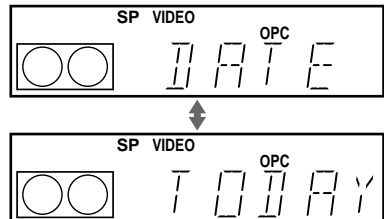

2

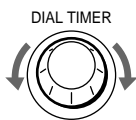

Turn DIAL TIMER to set the recording date.

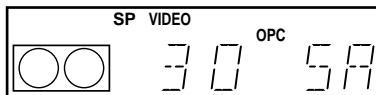

3



Press DIAL TIMER.

“START” and the current time appear alternately in the display window.

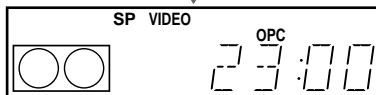
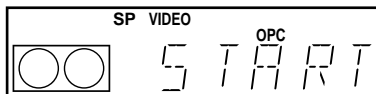

4

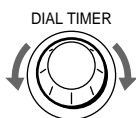

Turn DIAL TIMER to set the recording start time.

You can set the recording start time in 15 minute intervals or adjust the time in one minute intervals by pressing the PROGRAM +/- buttons.

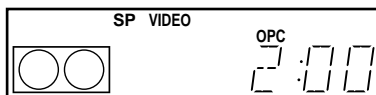

5



Press DIAL TIMER.

“STOP” and the recording stop time appear alternately in the display window.

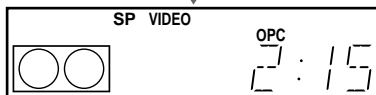
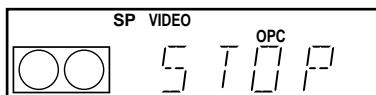

continued

- 6** Turn DIAL TIMER to set the recording stop time.
You can set the recording stop time in 15 minute intervals or adjust the time in one minute intervals by pressing the PROGRAM +/- buttons.

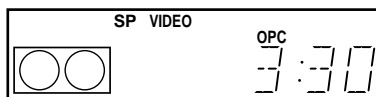
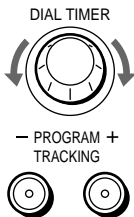

- 7** Press DIAL TIMER.
The programme position or station name appears in the display window.



- 8** Turn DIAL TIMER to set the programme position.
To record from a decoder or other source connected to one or more of the LINE inputs, turn DIAL TIMER or press INPUT SELECT to display the connected line in the display window.

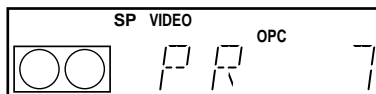
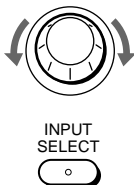

- 9** Press DIAL TIMER to complete the setting.
"OK" appears in the display window for about five seconds.
The ⊖ indicator appears in the display window and the VCR stands by for recording.



To record from a decoder or other source, leave the connected equipment switched on.

To return to the previous step

To return to the previous step, press the PROGRAM + and – buttons on the VCR at the same time during any of the Dial Timer settings.

To stop recording

To stop the VCR while recording, press ■ STOP.

To use the VCR after setting the timer

To use the VCR before a recording begins, just press I/⏻. The ⏻ indicator turns off and the VCR switches on. Remember to press I/⏻ to reset the VCR to recording standby after using the VCR.

You can also do the following tasks while the VCR is recording:

- Reset the counter (page 42).
- Display tape information on the TV screen (page 45).
- Check the timer settings (page 67).
- Watch another TV programme (page 45).

To set the clock

- 1 Turn DIAL TIMER so that “CLOCK” appears in the display window.
- 2 Press DIAL TIMER.
“DAY” appears in the display window.
- 3 Turn DIAL TIMER to set the day.
- 4 Press DIAL TIMER.
“MONTH” appears in the display window.
- 5 Turn and press DIAL TIMER to set the month, and then the year.
After you set the year, “CLOCK” appears in the display window again.
- 6 Turn and press DIAL TIMER to set the hour and minute.
- 7 When you have finished setting the time, press DIAL TIMER to start the clock.

Tips

- To cancel a Dial Timer setting, press ■ STOP on the VCR while you are making the setting.
- The programme is recorded in the current tape speed mode. To change the tape speed, press SP/LP before you complete the setting in step 9.
- When you are recording a programme in the SP mode and the remaining tape becomes shorter than the recording time, the tape speed is automatically changed to the LP mode. Note that some interference will appear on the picture at the point the tape speed is changed. If you want to keep the same tape speed, set AUTO LONG PLAY to OFF in the OPTIONS-1 menu (page 74).
- To check, change, or cancel the programme setting, see “Checking/changing/cancelling timer settings” (page 67).

Notes

- If eight programmes have already been set using the ShowView system or the TIMER menu, “FULL” appears in the display window for about five seconds.
- The ⏻ indicator flashes in the display window when you complete the setting in step 9 with no tape inserted.
- If you set the clock using the Auto Clock Set function and AUTO ADJUST is set to ON, the clock will adjust itself to the incoming time signal regardless of adjustments made with the Dial Timer. Be sure you have set the Auto Clock Set correctly.
- The station name may not appear if the VCR does not receive station name information signals.

continued

About the Demonstration Mode

The Dial Timer function has a Demonstration Mode that allows the user, such as a salesperson, to enter more than eight examples of timer settings when demonstrating the use of the Dial Timer. It cancels the FULL notice which appears if eight programmes have already been set. Do not use the Demonstration Mode for making timer recordings. Doing so may cause the settings to be inaccurate.

To activate the Demonstration Mode

Press ■■ (pause) on the VCR while turning the DIAL TIMER. “DEMO” appears in the display window for a few seconds.

To cancel the Demonstration Mode

Turn the power off and unplug the mains lead. Although the Demonstration Mode is cancelled, the timer settings entered while using the Demonstration Mode will remain. Be sure to manually cancel the timer settings before you use the Dial Timer or any other timer method after reconnecting the mains lead (see page 67).

Recording TV programmes using the ShowView system

(not available on SLV-SE100A1/A2)

The ShowView system is the feature that simplifies programming the VCR to make timer recordings. Just enter the ShowView number listed in the TV programme guide. The date, times, and programme position of that programme are set automatically. You can preset a total of eight programmes, including settings made with other timer methods.

Before you start...

- Check that the VCR clock is set to the correct time and date.
- Insert a tape with its safety tab in place. Make sure the tape is longer than the total recording time.
- To record from a decoder, turn it on.
- Turn on your TV and set it to the video channel.
- Set **TIMER OPTIONS** to **SHOWVIEW** or **VARIABLE** in the **OPTIONS-2** menu (see page 75).

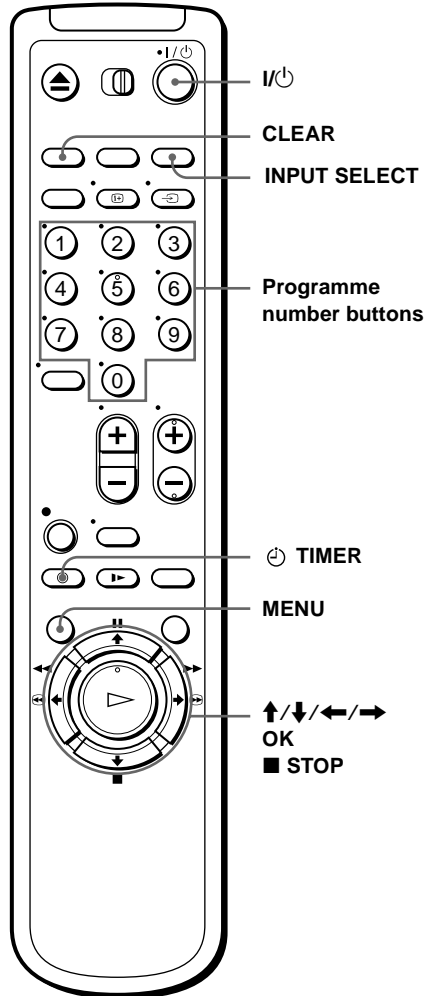

continued

1

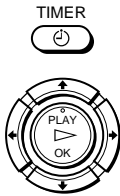

Press TIMER.

- When you set TIMER OPTIONS to VARIABLE:
The TIMER METHOD menu appears on the TV screen. Press to select SHOWVIEW, then press OK.

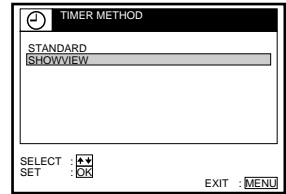

- When you set TIMER OPTIONS to SHOWVIEW:
The SHOWVIEW menu appears on the TV screen.

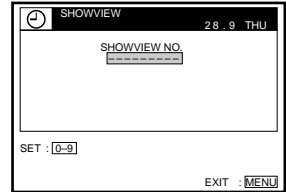

2

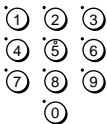

Press the programme number buttons to enter the ShowView number.

If you make a mistake, press CLEAR and re-enter the correct number.

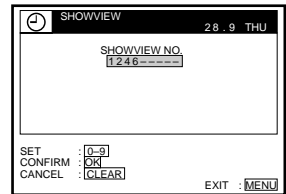

3



Press OK.

The date, start and stop times, programme position or station name, tape speed*1, and VPS/PDC setting*2 appear on the TV screen.



- If “- -” appears in the “PROG.” (programme) column (this may happen for local broadcasts), you have to set the appropriate programme position manually. Press to select the desired programme position.

To record from a decoder or other source connected to one or more of the LINE inputs, press INPUT SELECT to display the connected line in the “PROG.” position.

You will only have to do this operation once for the referred channel. The VCR will then store your setting.

- When you have selected A (Austria), CH (Switzerland), or D (Germany) with the country selection in the Auto Set Up procedure, the VPS/PDC function is automatically set to ON.

For details about the VPS/PDC function, see “Timer recording with VPS/PDC signals (not available on SLV-SE250P and SE450P)” on page 55.

If the information is incorrect, press CLEAR to cancel the setting.

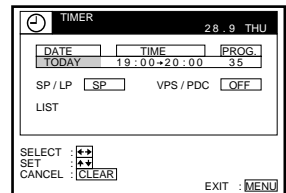

4

If you want to change the date, tape speed*1, and the VPS/PDC setting*2:

1 Press ←/→ to highlight the item you want to change.

2 Press ↑/↓ to reset it.

- To record the same programme every day or the same day every week, see “Daily/weekly recording” on page 55.
- To use the VPS/PDC function*2, set VPS/PDC to ON.

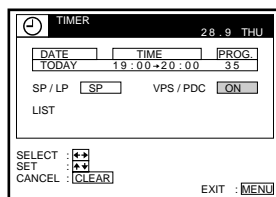
**5**

Press MENU to exit the menu.

6

Press I/⏻ to turn off the VCR.

The ⏻ indicator appears in the display window and the VCR stands by for recording.

To record from a decoder or other source, leave the connected equipment switched on.

To stop recording

To stop the VCR while recording, press ■ STOP.

Daily/weekly recording

In step 4 above, press ↓ to select the recording pattern. Each time you press ↓, the indication changes as shown below. Press ↑ to change the indication in reverse order.

TODAY → **SUN-SAT** (Sunday to Saturday) → **MON-SAT** (Monday to Saturday) → **MON-FRI** (Monday to Friday) → **SAT** (every Saturday) → **MON** (every Monday) → **SUN** (every Sunday) → 1 month later → (dates count down) → **TOMORROW** → **TODAY**

Timer recording with VPS/PDC signals (not available on SLV-SE250P and SE450P)

Some broadcast systems transmit VPS (Video Programme System) or PDC (Programme Delivery Control) signals with their TV programmes. These signals ensure that your timer recordings are made regardless of broadcast delays, early starts, or broadcast interruptions (when the VPS or PDC indicator in the display window is lit).

To use the VPS/PDC function, set VPS/PDC to ON in step 4 above. You can also use the VPS/PDC function for a source connected to one or more of the LINE inputs.

continued

To record satellite broadcasts

If you connect a satellite tuner and the VCR, you can record satellite programmes.

- 1 Turn on the satellite tuner.
- 2 On the satellite tuner, select the satellite programme for which you want to make a timer setting.
- 3 Follow steps 1 through 6 above.
- 4 Keep the satellite tuner turned on until the VCR finishes recording the satellite programme for which you have made a timer setting.

To use the VCR after setting the timer

To use the VCR before a recording begins, just press **I/⏻**. The **⏻** indicator turns off and the VCR switches on. Remember to press **I/⏻** to reset the VCR to recording standby after using the VCR.

You can also do the following tasks while the VCR is recording:

- Reset the counter (page 42).
- Display tape information on the TV screen (page 45).
- Check the timer settings (page 67).
- Watch another TV programme (page 45).

Tips

- To set the programme position, you can also use the **PROG +/-** or programme number buttons.
- To set the programme position with a two digit number, press **-/-** (ten's digit) button followed by the programme number buttons.
- To set the line input video source, you can also use the **PROG +/-** buttons.
- To set the tape speed, you can also use the **SP/LP** button*¹.
- When you are recording a programme in the **SP** mode and the remaining tape becomes shorter than the recording time, the tape speed is automatically changed to the **LP** mode. Note that some interference will appear on the picture at the point the tape speed is changed. If you want to keep the same tape speed, set **AUTO LONG PLAY** to **OFF** in the **OPTIONS-1** menu (page 74).*¹
- To check, change, or cancel the programme setting, press **◀/▶** to choose **LIST**, then press **OK** in step 4. For details, see step 3 in "Checking/changing/cancelling timer settings" (page 67).

Notes

- If the **VPS/PDC***² signal is too weak or the broadcasting station failed to transmit **VPS/PDC** signals, the VCR will start recording at the set time without using the **VPS/PDC** function.
- The **⏻** indicator flashes in the display window when you press **I/⏻** with no tape inserted.
- When you set **TIMER OPTIONS** to **STANDARD** in the **OPTIONS-2** menu, the **SHOWVIEW** menu does not appear on the TV screen. Select **SHOWVIEW** or **VARIABLE**.
- The **VPS/PDC** function*² is automatically set to **OFF** for the timer recording of a satellite programme.
- The station name may not appear if the VCR does not receive station name information signals.

*¹ not available on SLV-SE200V1/V2

*² not available on SLV-SE250P and SE450P

Recording TV programmes using the timer

You can preset a total of eight programmes, including settings made with other timer methods.

Before you start...

- Check that the VCR clock is set to the correct time and date.
- Insert a tape with its safety tab in place. Make sure the tape is longer than the total recording time.
- To record from a decoder, turn it on.
- Turn on your TV and set it to the video channel.
- Set **TIMER OPTIONS** to **STANDARD** or **VARIABLE** in the **OPTIONS-2** menu (see page 75).^{*1}

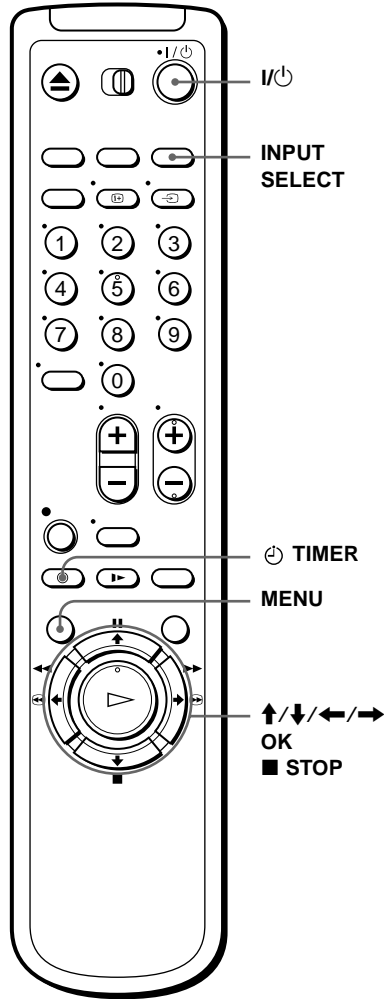

continued

1

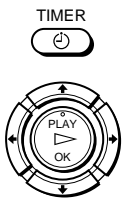

Press TIMER.

For SLV-SE100A1/A2:

The TIMER menu appears on the TV screen.

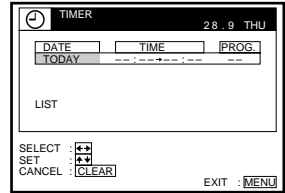

For SLV-SE200V1/V2, SE250D/P, SX250D, SE300D1/D2, SE450D/P, and SE480D:

- When you set **TIMER OPTIONS** to **VARIABLE**:
The **TIMER METHOD** menu appears on the TV screen. Press to select **STANDARD**, then press **OK**.
- When you set **TIMER OPTIONS** to **STANDARD**:
The **TIMER** menu appears on the TV screen.

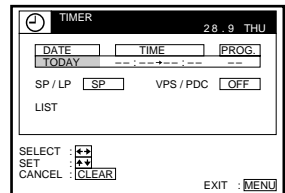
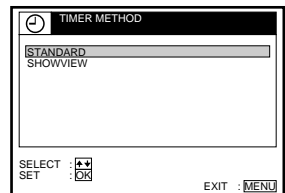

2



Set the date, start and stop times, programme position or station name*¹, tape speed*², and VPS/PDC function*³:

1 Press to highlight each item in turn.

2 Press to set each item.

To correct a setting, press to return to that setting and reset.

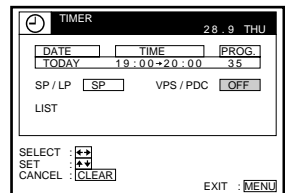

- To record the same programme every day or the same day every week, see “Daily/weekly recording” on page 59.
- To use the VPS/PDC function*³, set VPS/PDC to ON. For details about the VPS/PDC function, see “Timer recording with VPS/PDC signals (not available on SLV-SE250P and SE450P)” on page 55.
- To record from a decoder or other source connected to one or more of the LINE inputs, press **INPUT SELECT** to display the connected line in the “PROG.” position.

3



Press MENU to exit the menu.

4



Press I/⏻ to turn off the VCR.

The ⏻ indicator appears in the display window and the VCR stands by for recording.

To record from a decoder or other source, leave the connected equipment switched on.

To stop recording

To stop the VCR while recording, press ■ STOP.

Daily/weekly recording

In step 2 above, press ↓ to select the recording pattern. Each time you press ↓, the indication changes as shown below. Press ↑ to change the indication in reverse order. **TODAY → SUN-SAT (Sunday to Saturday) → MON-SAT (Monday to Saturday) → MON-FRI (Monday to Friday) → SAT (every Saturday) → MON (every Monday) → SUN (every Sunday) → 1 month later → (dates count down) → TOMORROW → TODAY**

To use the VCR after setting the timer

To use the VCR before a recording begins, just press I/⏻. The ⏻ indicator turns off and the VCR switches on. Remember to press I/⏻ to reset the VCR to recording standby after using the VCR.

You can also do the following tasks while the VCR is recording:

- Reset the counter (page 42).
- Display tape information on the TV screen (page 45).
- Check the timer settings (page 67).
- Watch another TV programme (page 45).

Tips

- To set the programme position, you can also use the PROG +/- or programme number buttons.
- To set the programme position with a two digit number, press -/- (ten's digit) button followed by the programme number buttons.
- To set the line input video source, you can also use the PROG +/- buttons.
- To set the tape speed, you can also use the SP/LP button*2.
- When you are recording a programme in the SP mode and the remaining tape becomes shorter than the recording time, the tape speed is automatically changed to the LP mode. Note that some interference will appear on the picture at the point the tape speed is changed. If you want to keep the same tape speed, set AUTO LONG PLAY to OFF in the OPTIONS-1 menu (page 74).*2
- Even if you set TIMER OPTIONS*1 to SHOWVIEW in the OPTIONS-2 menu, you can set the timer manually. Press MENU to select TIMER, then go to step 2.
- To check, change, or cancel the programme setting, press ←/→ to choose LIST, then press OK in step 2. For details, see step 3 in "Checking/changing/cancelling timer settings" (page 67).

continued

Notes

- When setting the timer with VPS/PDC*³ signals, enter the start and stop times exactly as indicated in the TV programme guide. Otherwise, the VPS/PDC function won't work.
- If the VPS/PDC*³ signal is too weak or the broadcasting station failed to transmit VPS/PDC signals, the VCR will start recording at the set time without using the VPS/PDC function.
- The  indicator flashes in the display window when you press I/⏮ with no tape inserted.
- The VPS/PDC function*³ is automatically set to OFF for the timer recording of a satellite programme.
- The station name*¹ may not appear if the VCR does not receive station name information signals.

*¹ not available on SLV-SE100A1/A2

*² not available on SLV-SE100A1/A2 and SE200V1/V2

*³ not available on SLV-SE100A1/A2, SE250P, and SE450P

Playing/searching at various speeds

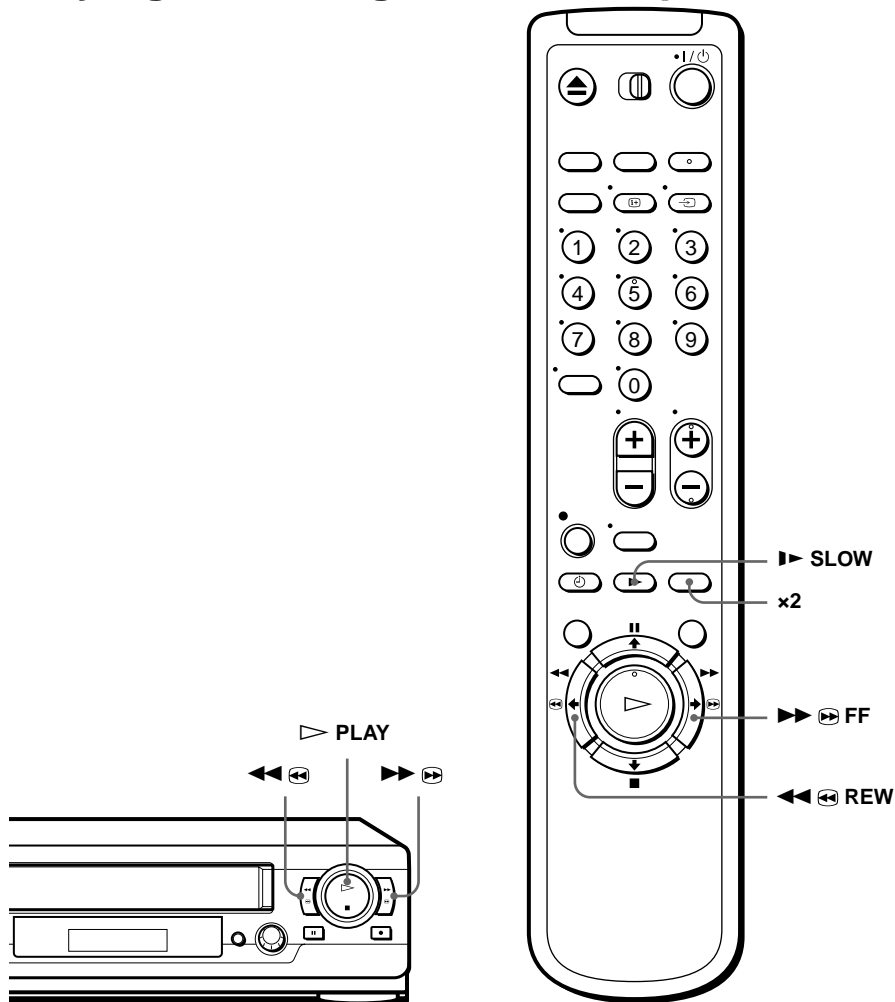

Playback options	Operation
View the picture during fast-forward or rewind	During fast-forward, hold down ►►►► FF/►►►► . During rewind, hold down ◀◀◀◀ REW/◀◀◀◀ .
Play at high speed	<ul style="list-style-type: none"> • During playback, press ►►►► FF or ◀◀◀◀ REW <u>on the remote commander.</u> • During playback, hold down ►►►► FF/►►►► or ◀◀◀◀ REW/◀◀◀◀ . When you release the button, normal playback resumes.

continued

Playback options	Operation
Play at twice the normal speed* ¹	During playback, press ×2.
Play in slow motion	During playback, press ►► SLOW.
Play frame by frame	During pause, press ►► ⏮ FF or ◀◀ ⏪ REW <u>on the remote commander</u> . Hold down ►► ⏮ FF or ◀◀ ⏪ REW to play one frame each second.
Rewind and start play	During stop, press ▷ PLAY <u>on the VCR</u> while holding down ◀◀ ⏪ <u>on the VCR</u> .

To resume normal playback

Press ▷ PLAY.

Tip

- Adjust the picture using the TRACKING +/- buttons if:
 - Streaks appear while playing in slow motion.
 - Bands appear at the top or bottom while pausing.
 - The picture shakes while pausing.
 To set tracking to the centre position, press both buttons (+/-) at the same time.

Notes

- The sound is muted during these operations.
- In the LP mode*¹, noise may appear or there may be no colour.
- If the playback mode mark doesn't appear on the TV screen, press (i+) DISPLAY.
- The picture may show noise when playing at high speed in reverse.*²

*¹ not available on SLV-SE100A1/A2 and SE200V1/V2

*² SLV-SE100A1/A2, SE200V1/V2, SE250D/P, SX250D, and SE300D1/D2 only

Setting the recording duration time

After you have started recording in the normal way, you can have the VCR stop recording automatically after a specified duration.

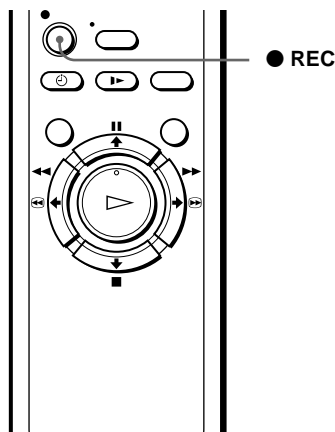

- 1 While recording, press ● REC.

The ⌚ indicator appears in the display window.

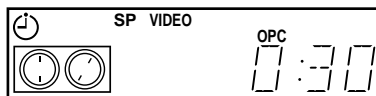

- 2 Press ● REC repeatedly to set the duration time.

Each press advances the time in increments of 30 minutes.

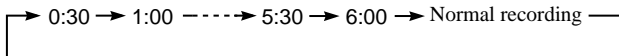

The tape counter decreases minute by minute to 0:00, then the VCR stops recording and turns off automatically.

To extend the duration

Press ● REC repeatedly to set a new duration time.

To cancel the duration

Press ● REC repeatedly until the ⌚ indicator disappears and the VCR returns to the normal recording mode.

To stop recording

To stop the VCR while recording, press ■ STOP.

Note

- You cannot display the current tape time in the display window when setting the recording duration time.

Synchronized Recording

(SLV-SE300D1/D2 and SE480D only)

You can set the VCR to automatically record programmes from equipment such as a satellite tuner by connecting the equipment to the DECODER/LINE-3 IN connector. The connected equipment must have a timer function for this feature to work.

When the connected equipment turns on, the VCR also automatically turns on and starts recording a programme from DECODER/LINE-3 IN.

How to connect for Synchronized Recording

Connect the DECODER/LINE-3 IN connector of the VCR to the **TV Scart** connector of the satellite tuner. Then connect the LINE-1 (TV) connector to the TV.

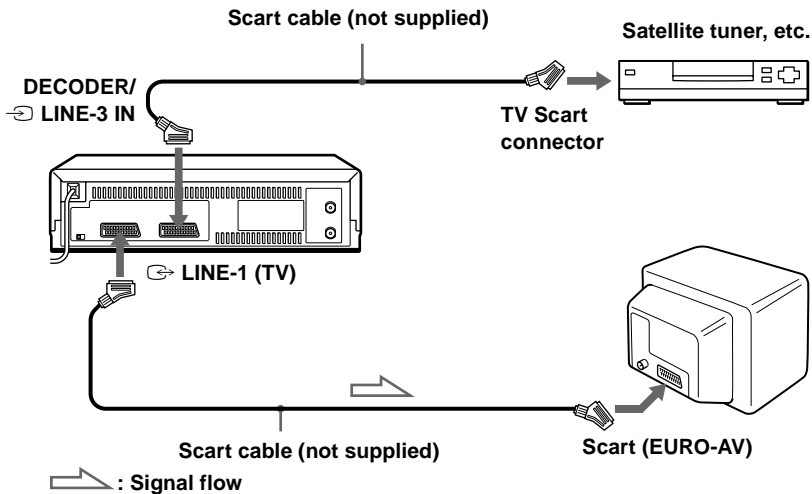

Recording programmes using the Synchronized Recording function

Before you start...

- Insert a tape with its safety tab in place.
Make sure the tape is longer than the total recording time.
- Set DECODER/LINE3 to LINE3 in the OPTIONS-2 menu (see page 75).

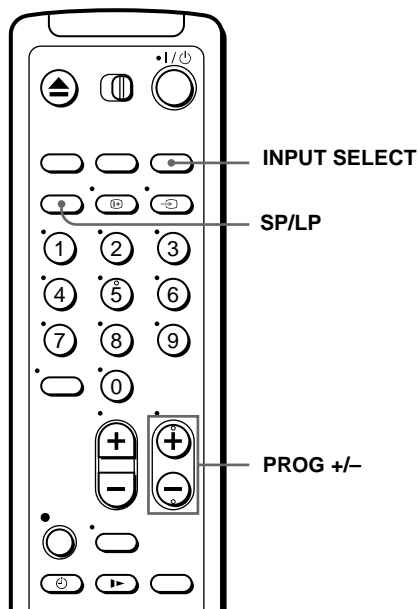
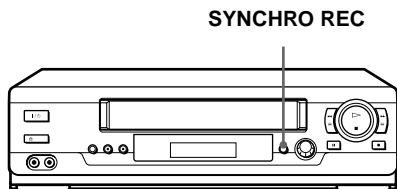

- 1** Press INPUT SELECT or PROG +/- to display "L3" in the display window.
- 2** Set the timer on the connected equipment to the time of the programme you want to record, then turn it off.
- 3** Press SP/LP to select the tape speed.
- 4** Hold down SYNCHRO REC for more than two seconds.
The SYNCHRO REC button lights up and the VCR stands by for recording.
The VCR automatically turns on and starts recording when it receives an input signal from the connected equipment.
The VCR automatically stops recording when the tape reaches the end or when the connected equipment stops transmitting an input signal.

To cancel the Synchronized Recording function

Press SYNCHRO REC. The SYNCHRO REC button turns off.

To stop recording

Press ■ STOP while recording.

continued

Notes

- This function may not work with some types of satellite tuners.
- Some TVs or other equipment with timer functions will automatically turn off if no operation is performed within a certain amount of time. In this case, the Synchronized Recording also stops automatically.
- When the connected equipment turns on while the SYNCHRO REC button is lit, recording starts automatically.
- If the settings for timer recording and Synchronized Recording overlap, the programme that starts first has priority and the second programme starts recording only after the first programme has finished.
- The Auto Clock Set function does not work while the VCR stands by for Synchronized Recording.

Checking/changing/cancelling timer settings

Before you start...

- Turn on your TV and set it to the video channel.

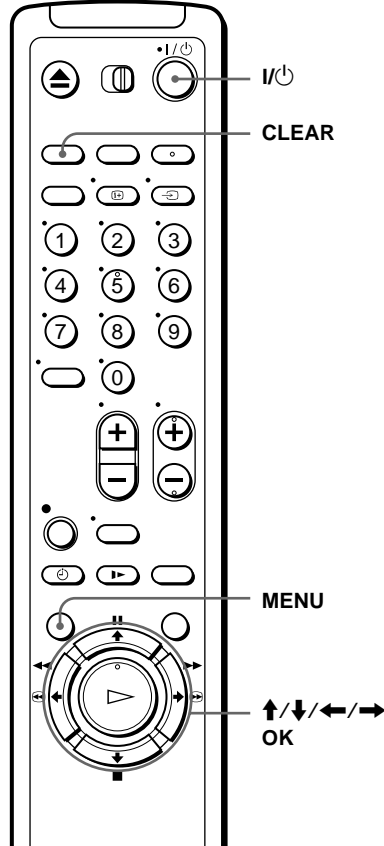

- 1 Press I/Power to turn on the VCR.
- 2 Press MENU, then press **↑/↓** to highlight LISTS and press OK.
- 3 Press **↑/↓** to highlight TIMER LIST, then press OK:

- If you want to change or cancel a setting, go on to the next step.
- If you do not need to change or cancel the settings, press MENU, then turn off the VCR to return to recording standby.

TIMER LIST				28	9	THU
DATE	TIME	PROG.	SP			
TODAY	18:00-20:00	3A	SP			
30.9	20:00-21:00	AAB	LP			
2.10	10:00-11:30	CDE	LP			
MON-FRI	14:00-15:00	FGH	LP			
SUN	6:30-7:00	IJK	SP			
---	---	---	---			

[RETURN]
 SELECT : **↑/↓**
 SET : **OK**
 CANCEL : **CLEAR**

EXIT : **MENU**

continued

- 4 Press **↑/↓** to select the setting you want to change or cancel, then press OK.

The selected setting appears in the TIMER menu.

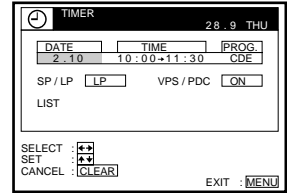

- 5 • To change the setting, press **←/→** to highlight the item you want to change, then press **↑/↓** to reset it.
- To cancel the setting, press CLEAR.

- 6 Press MENU to exit the menu.

If any settings remain, turn off the VCR to return to recording standby.

When the timer settings overlap

The programme that starts first has priority and the second programme starts recording only after the first programme has finished. If the programmes start at the same time, the programme listed first in the menu has priority.

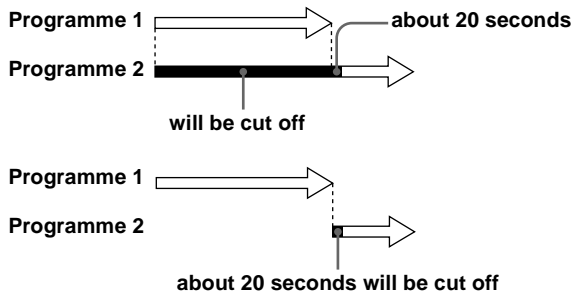

Tip

- In step 6 above, you can check the TIMER LIST by selecting LIST and pressing OK. Press MENU to exit the TIMER LIST.

Searching using the Smart Search function

If you record multiple programmes on a tape, use the Smart Search function to see what has been recorded on your tape. You can see information such as date, time, and programme position of programmes recorded on a tape. You can also start playback directly from the selected programme using the SMART SEARCH screen.

All programmes are listed on the screen, regardless of how the programme was recorded.

The data of the last tape inserted into the VCR is automatically stored in memory. If you want to recall the latest data screen, select LATEST DATA in the SMART SEARCH screen (see page 70).

Before you start...

- Turn on your TV and set it to the video channel.

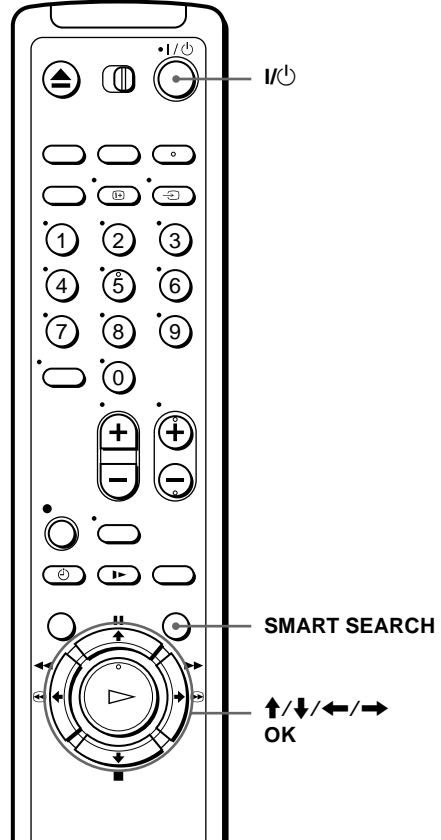

- 1 After recording, press I/O to turn on the VCR.
- 2 Press SMART SEARCH.
- 3 Press ↑/↓/←/→ to select the programme you want to start viewing.

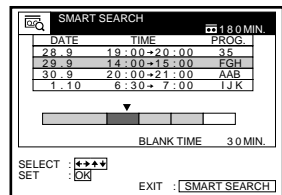

continued

4 Press OK.

The VCR starts searching, and playback starts automatically from the beginning of the selected programme.

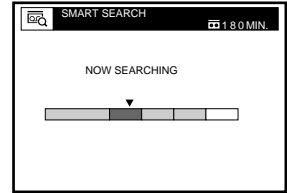

To stop searching

Press ■ STOP.

To exit the SMART SEARCH screen

Press SMART SEARCH.

To record in a blank space

Blank space on the tape will appear as a blank row in the SMART SEARCH screen. Select the last blank row in step 3, then press OK. The VCR rewinds/fast-forwards the tape to the beginning of the blank space, then stops. Start recording. Note that “BLANK TIME” and the remaining time indication only refers to the length of the last blank space.

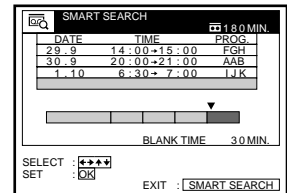

To recall the latest data screen after you remove the tape

You can display the data of the last tape used to record a programme, even after you have removed the tape.

If you reinsert the tape and record additional programmes, be sure to select LATEST DATA. Otherwise, all of the data for the tape is deleted.

1 Reinsert the last tape that you used to record a programme.

2 Press SMART SEARCH.

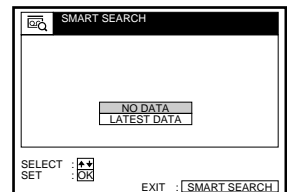

3 Press \uparrow/\downarrow to highlight LATEST DATA.

If you want to reset the latest data screen, highlight NO DATA and press OK, then record a programme.

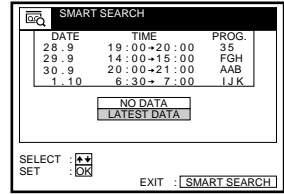

4 Press OK.

The latest data stored in the VCR's memory is displayed.

Tips

- You can store information for up to 24 programmes on a single list.
- While recording, you can display the SMART SEARCH screen using the SMART SEARCH button. If you decide to stop recording, press SMART SEARCH to make the SMART SEARCH screen disappear first. Then press \blacksquare STOP.

Notes

- You cannot use this function unless the clock is set.
- Depending on the tape, the total or remaining time may not appear correctly.
- If many short programmes are recorded on a tape, multiple programmes may be included in a single block. In this case, only the latest programme information will appear in the SMART SEARCH screen.
- Blank time is measured from the end of the last recorded programme to the end of the tape. However, if you eject the tape and then make a new recording on the same tape, the original recorded programme(s) is displayed as a blank space.
- If no information is stored in the VCR's memory, LATEST DATA does not appear in the SMART SEARCH screen.
- The station name* may not appear if the VCR does not receive station name information signals.
- If you start recording a programme "D" from the middle of a previously recorded programme "A" and into another previously recorded programme "B," the Smart Search information for the second programme "B," which is recorded over, is deleted.

Originally recorded programmes

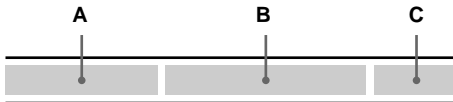

Recording the programme "D" over the programme "A" and "B"

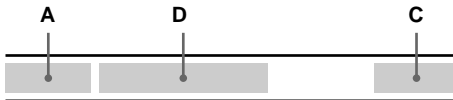

* not available on SLV-SE100A1/A2

Adjusting the picture

Adjusting the tracking

Although the VCR automatically adjusts the tracking when playing a tape (the  indicator flashes in the display window, then turns off), distortion may occur if the recording is in poor condition. In this case, manually adjust the tracking.

During playback, press TRACKING +/- to display the tracking meter. The distortion should disappear as you press one of the two buttons (the  indicator lights up). To resume automatic tracking adjustments, eject the tape and re-insert it.

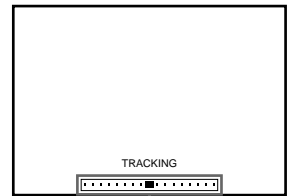

Tracking meter

About the Optimum Picture Control (OPC) function

The Optimum Picture Control (OPC) function automatically improves recording and playback quality by adjusting the VCR to the condition of the video heads and tape. To maintain better picture quality, we recommend that you set OPC to ON in the OPTIONS-1 menu (the OPC indicator lights up in the display window). For details, see page 74.

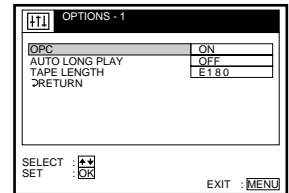

OPC playback

The OPC function automatically works on all types of tapes, including rental tapes and tapes that were not recorded with OPC.

OPC recording

Whenever you insert a tape and start recording for the first time, the VCR adjusts to the tape using the OPC function (the OPC indicator flashes rapidly). This adjustment is retained until the tape is ejected.

To deactivate the OPC function

Set OPC to OFF in the OPTIONS-1 menu. The OPC indicator in the display window turns off.

Tip

- To set tracking to the centre position, press the TRACKING + and – buttons at the same time.

Notes

- You can adjust the tracking for an NTSC*¹-recorded tape but the tracking meter won't be displayed.
- With the Auto Long Play function on, the OPC function will work only in SP mode. If the tape speed automatically switches from SP to LP, the OPC function turns off. If, however, the entire programme is recorded in LP mode, the OPC function will work.*²
- There is a delay of about ten seconds before the VCR actually starts recording while the VCR analyses the tape. To avoid the delay, first set the VCR to recording pause (the OPC indicator flashes slowly) and press ● REC to have the VCR analyse the tape (the OPC indicator flashes rapidly) and return to recording pause. After the OPC indicator stops flashing, press ■■ PAUSE to start recording immediately.
If you want to start recording quickly without using the OPC function, first set the VCR to recording pause (the OPC indicator flashes slowly) and press ■■ PAUSE again to start recording.

*¹ SLV-SE100A1/A2 cannot play NTSC-recorded tapes.

*² not available on SLV-SE100A1/A2 and SE200V1/V2

Changing menu options

- 1 Press MENU, then select OPTIONS and press OK.

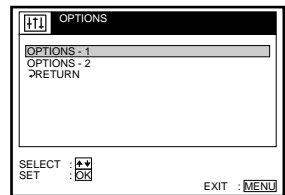

- 2 Press \uparrow/\downarrow to highlight OPTIONS-1 or OPTIONS-2, then press OK.

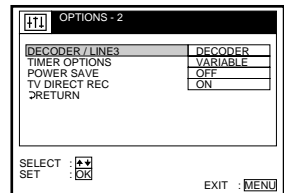
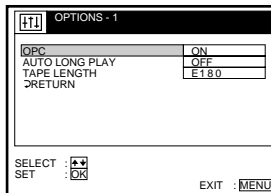

- 3 Press \uparrow/\downarrow to select the option, then press OK.
- 4 Press \uparrow/\downarrow to change the setting, then press OK.
- 5 Press MENU to return to the original screen.



Menu choices

Initial settings are indicated in bold print.

OPTIONS-1

Menu option	Set this option to
OPC	<ul style="list-style-type: none"> • ON to switch on the OPC (Optimum Picture Control) function and improve picture quality. • OFF to switch off OPC.
AUTO LONG PLAY*1	<ul style="list-style-type: none"> • ON to change the timer recording tape speed automatically to the LP mode when the remaining tape length becomes shorter than the recording time. Note that for AUTO LONG PLAY to work correctly, the TAPE LENGTH setting must be accurate. • OFF to keep the set tape speed.
TAPE LENGTH	<ul style="list-style-type: none"> • E180 to use an E-180 or shorter type tape. • E195 to use an E-195 type tape. • E240 to use an E-240 type tape. • E300 to use an E-300 type tape.

OPTIONS-2

Menu option	Set this option to
DECODER/LINE2*2	<ul style="list-style-type: none"> • DECODER to use the DECODER/LINE-2 IN*2 connector as the PAY-TV/Canal Plus decoder connector. • LINE2*2 to use the DECODER/LINE-2 IN*2 connector as the line input connector.
DECODER/LINE3*3	<ul style="list-style-type: none"> • DECODER to use the DECODER/LINE-3 IN*3 connector as the PAY-TV/Canal Plus decoder connector. • LINE3*3 to use the DECODER/LINE-3 IN*3 connector as the line input connector.
TIMER OPTIONS*4	<ul style="list-style-type: none"> • VARIABLE to display the TIMER METHOD menu for selecting STANDARD or SHOWVIEW when pressing the  TIMER button. • STANDARD to display the TIMER menu when pressing the  TIMER button. • SHOWVIEW to display the SHOWVIEW menu when pressing the  TIMER button. <p>For details, see page 53 and 57.</p>
POWER SAVE	<ul style="list-style-type: none"> • ON to turn off the indicators in the display window to conserve the VCR's power. • OFF to turn on the indicators in the display window while the VCR is standing by.
TV DIRECT REC*4	<ul style="list-style-type: none"> • ON to activate the TV Direct Rec function. • OFF to deactivate it.

Note

- When you set a timer recording, the indicators in the display window remain on, even though POWER SAVE is set to ON.

*1 not available on SLV-SE100A1/A2 and SE200V1/V2

*2 SLV-SE250D/P, SX250D, and SE450D/P only

*3 SLV-SE300D1/D2 and SE480D only

*4 not available on SLV-SE100A1/A2

Editing with another VCR

How to connect to record on this VCR

Connect the line outputs of the other VCR to the LINE IN connector or jacks of this VCR. Refer to the examples A through C and choose the connection that best suits your VCR.

Example A

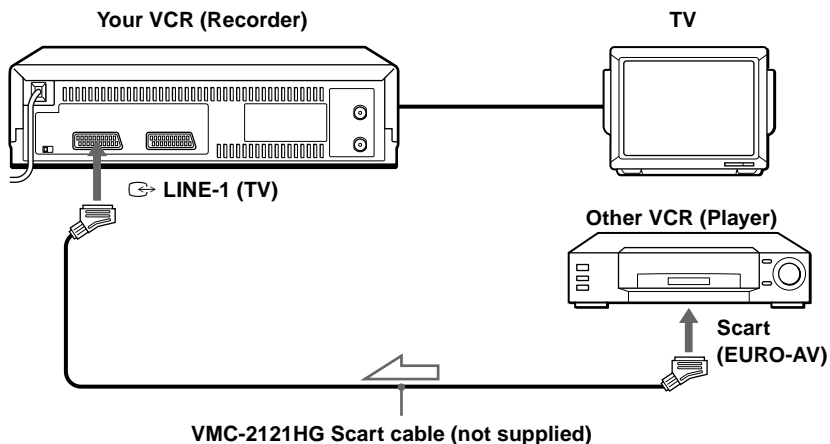

 : Signal flow

Example B

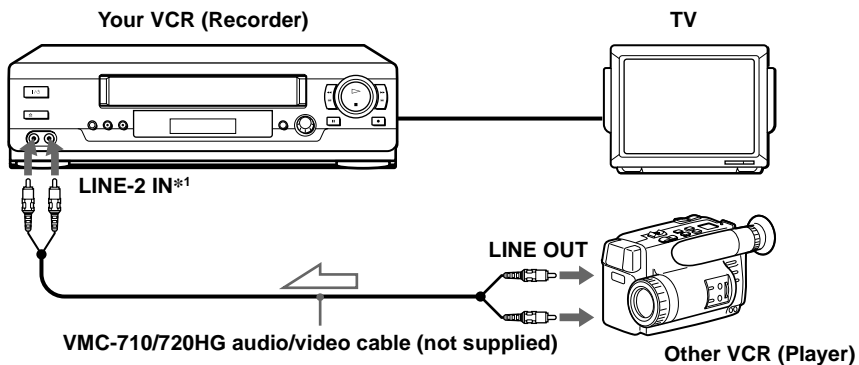

 : Signal flow

Example C

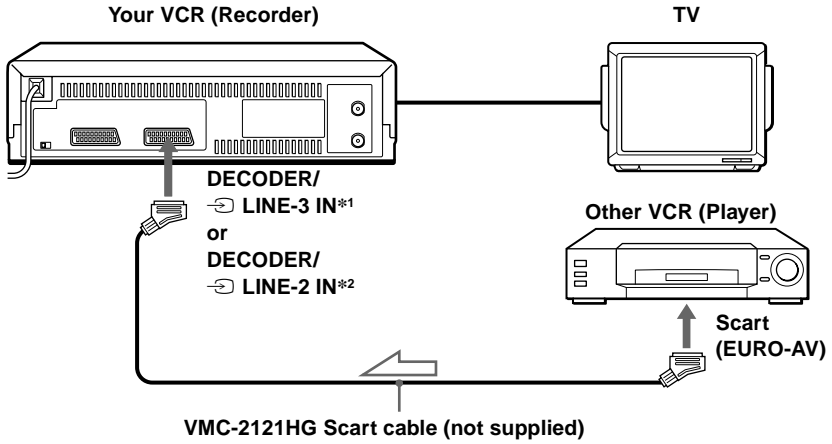

 : Signal flow

Notes

- Make sure you connect the plugs to jacks of the same colour.*1
- If you connect this VCR to both the LINE IN and LINE OUT jacks of the other VCR, select the input correctly to prevent a humming noise.
- If the other VCR does not have a Scart (EURO-AV) connector, use the VMC-2106HG cable instead and connect the cable to the line out jacks of the other VCR.
- When you connect another VCR to the DECODER/LINE-3 IN *1 (or DECODER/LINE-2 IN*2) connector, set DECODER/LINE3*1 (or DECODER/LINE2*2) to LINE3*1 (or LINE2*2) in the OPTIONS-2 menu.

*1 SLV-SE300D1/D2 and SE480D only

*2 SLV-SE250D/P, SX250D, and SE450D/P only

continued

Operation (when recording on this VCR)

Before you start editing

- Turn on your TV and set it to the video channel.
- Press INPUT SELECT to display the connected line in the display window.
- Press SP/LP to select the tape speed, SP or LP*.

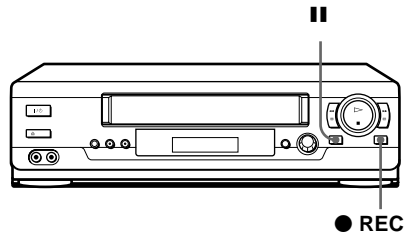

- 1** Insert a source tape with its safety tab removed into the other (playback) VCR. Search for the point to start playback and set it to playback pause.
- 2** Insert a tape with its safety tab in place into this (recording) VCR. Search for the point to start recording and press **II** (pause).
- 3** Press **● REC** on this VCR to set it to recording pause.
- 4** To start editing, press the **II** (pause) buttons on both VCRs at the same time.

To stop editing

Press the **■ STOP** buttons on both VCRs.

Tip

- To cut out unwanted scenes while editing, press **II** (pause) on this VCR when an unwanted scene begins. When it ends, press **II** (pause) again to resume recording.

Note

- If you start editing following the procedure above, the VCR won't start recording with the OPC function. To record a tape with the OPC function, press **● REC** again during recording pause in step 3 so the VCR analyses the tape. Then, press **II** (pause) after the OPC indicator stops flashing to start recording. If you press **II** (pause) before the OPC indicator stops flashing, the OPC function is cancelled.

* not available on SLV-SE100A1/A2 and SE200V1/V2

Troubleshooting

If you have any questions or problems not covered below, please consult your nearest Sony service facility.

	Symptom	Remedy
Power	The I/ON/STANDBY switch does not function.	<ul style="list-style-type: none"> Connect the mains lead to the mains securely.
	The power is turned on but the VCR does not operate.	<ul style="list-style-type: none"> Moisture condensation has occurred. Turn the power off, unplug the mains lead and leave the VCR to dry for over three hours.
	The VCR is plugged in but the display window remains dark.	<ul style="list-style-type: none"> Set POWER SAVE in the OPTIONS-2 menu to OFF (see page 75).
Clock	The clock has stopped and “--:--” appears in the display window.	<ul style="list-style-type: none"> The clock stops if the VCR is disconnected from the mains for more than one hour. Reset the clock (and timer).
Playback	The playback picture does not appear on the TV screen.	<ul style="list-style-type: none"> Make sure the TV is set to the video channel. If you are using a monitor, set it to video input. If the VCR is connected to the TV with the Scart cable, make sure the VIDEO indicator is lit in the display window. Use the TV/VIDEO button on the remote commander to light up the VIDEO indicator.
	The picture is not clear.	<ul style="list-style-type: none"> If your TV is connected to the VCR with both Scart and aerial cables, make sure the RF channel is set to OFF (see page 15). Existing broadcasts may interfere with the VCR. Reset the RF channel output of your VCR. Adjust the tracking with the TRACKING +/- buttons. The video heads are dirty (see the last page of Troubleshooting). Clean the video heads using the Sony T-25CLD, E-25CLDR, or T-25CLW video head cleaning cassette. If these cleaning cassettes are not available in your area, have the heads cleaned at your nearest Sony service facility (a standard service charge will be required). Do not use a commercially available liquid type cleaning cassette other than Sony's, as it may damage the video heads. The video heads may have to be replaced. Consult your local Sony service facility for more information.
	The picture rolls vertically during picture search.	<ul style="list-style-type: none"> Adjust the vertical hold control on the TV or monitor.
	The picture has no sound.	<ul style="list-style-type: none"> The tape is defective. If you made A/V connections, check the audio cable connection.

continued

	Symptom	Remedy
Recording	No TV programme appears on the TV screen.	<ul style="list-style-type: none"> • Make sure the TV is set to the video channel. If you are using a monitor, set it to video input. • If your TV is connected to the VCR with both Scart and aerial cables, make sure the RF channel is set to OFF (see page 15). • Existing broadcasts may interfere with the VCR. Reset the RF channel output of your VCR. • Select the correct source with the INPUT SELECT button. Select a programme position when recording TV programmes; select a line input when recording from other equipment.
	TV reception is poor.	<ul style="list-style-type: none"> • Make sure the aerial cable is connected securely. • Adjust the TV aerial.
	The tape starts playing as soon as it is inserted.	<ul style="list-style-type: none"> • The safety tab has been removed. To record on this tape, cover the tab hole (see page 46).
	The tape is ejected when you press ● REC.	<ul style="list-style-type: none"> • The safety tab has been removed. To record on this tape, cover the tab hole (see page 46).
	Nothing happens when you press ● REC.	<ul style="list-style-type: none"> • Make sure the tape is not at its end.
Timer recording	The timer does not operate.	<ul style="list-style-type: none"> • Check that the clock is set. • Make sure a tape has been inserted. • Check that the safety tab has not been removed. • Make sure the tape is not at its end. • Make sure a programme has been set for timer recording. • Make sure your timer settings are past the current time. • Check that the decoder is turned on. • Check that the satellite tuner is turned on. • The clock stops if the VCR is disconnected from the mains for more than one hour. Reset the clock and timer. • Turn the power off and unplug the mains lead.
	The SHOWVIEW menu or the TIMER menu does not appear.	<ul style="list-style-type: none"> • Check that TIMER OPTIONS in the OPTIONS-2 menu is set correctly (see page 75).
	The VPS/PDC function does not operate properly.	<ul style="list-style-type: none"> • Check that the clock and the date are set correctly. • Check that the VPS/PDC time you set is the correct one (there might be a mistake in the TV programme guide). If the broadcast you wanted to record did not send the good VPS/PDC information, the VCR will not start recording. • If the reception is poor, the VPS/PDC signal might be altered and the VCR might not start recording.

	Symptom	Remedy
Synchronized Recording	The SYNCHRO REC button turns off while recording or does not go back to recording standby mode.	<ul style="list-style-type: none"> The tape has reached its end. Insert a new tape and press SYNCHRO REC again.
	The Synchronized Recording function does not work.	<ul style="list-style-type: none"> The connected equipment was not turned off. Turn off the connected equipment and press SYNCHRO REC again. There was a power failure. Press SYNCHRO REC again.
	The programme recorded with the Synchronized Recording function is incomplete.	<ul style="list-style-type: none"> If the settings for timer recordings and Synchronized Recording overlap, the programme that starts first has priority and the second programme starts recording only after the first programme has finished. There was a power failure. Press SYNCHRO REC again.
PAY-TV/Canal Plus	You cannot set channels as PAY-TV/Canal Plus in the TUNER menu.	<ul style="list-style-type: none"> Check that DECODER/LINE3 (or DECODER/LINE2) in the OPTIONS-2 menu is set to DECODER (see page 75).
	You cannot watch PAY-TV/ Canal Plus programmes when the VCR is in standby mode.	<ul style="list-style-type: none"> Check that DECODER/LINE3 (or DECODER/LINE2) in the OPTIONS-2 menu is set to DECODER (see page 75). Make sure the PAY-TV/Canal Plus Scart cable is plugged securely.
	A PAY-TV/Canal Plus programme is always recorded scrambled.	<ul style="list-style-type: none"> Make sure the PAY-TV/Canal Plus Scart cable is plugged securely. Check that DECODER/LINE3 (or DECODER/LINE2) in the OPTIONS-2 menu is set to DECODER (see page 75). Check that this channel is set as PAY-TV/Canal Plus in the TUNER menu (see page 37).

	Symptom	Remedy
Others	A tape cannot be inserted.	<ul style="list-style-type: none"> • Check that a tape isn't already in the tape compartment.
	The remote commander does not function.	<ul style="list-style-type: none"> • Make sure you are pointing the remote commander at the remote sensor on the VCR. • Replace all the batteries in the remote commander with new ones if they are weak. • Make sure the [TV] / [VIDEO] remote control switch is set correctly.
	The selected input line connector number does not appear in the display window.	<ul style="list-style-type: none"> • Check that DECODER/LINE3 (or DECODER/LINE2) in the OPTIONS-2 menu is set to LINE3 (or LINE2) (see page 75).
	The SMARTLINK function does not work.	<ul style="list-style-type: none"> • Check that your TV complies with SMARTLINK, MEGALOGIC, EASYLINK, Q-Link, EURO VIEW LINK, or T-V LINK. • Make sure you use the Scart cable to connect the VCR and your TV. • Make sure the Scart cable is connected securely.
	The tracking meter does not appear on the TV screen.	<ul style="list-style-type: none"> • The recording condition of the tape is very poor and tracking cannot be adjusted. • The tracking meter does not appear when playing back an NTSC-recorded tape.
	You cannot control other TVs.	<ul style="list-style-type: none"> • Set your TV's code number. The code number may change when you replace the batteries of the remote commander.
	The display window becomes dim.	<ul style="list-style-type: none"> • The display window automatically becomes dim when the VCR is in standby or timer recording mode.
	The VCR needs to be cleaned.	<ul style="list-style-type: none"> • Clean the cabinet, panel and controls with a dry, soft cloth, or a soft cloth slightly moistened with a mild detergent solution. Do not use any type of solvent, such as alcohol or benzene.

Symptoms caused by contaminated video heads

• Normal picture



• Rough picture

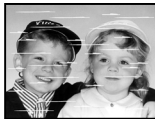

initial
contamination

• Unclear picture



• No picture (or
black & white
screen appears)

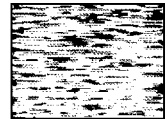

terminal



Specifications

System

Channel coverage

- PAL (B/G)
- VHF E2 to E12
- VHF Italian channel A to H
- UHF E21 to E69
- CATV S01 to S05, S1 to S20
- HYPER S21 to S41

RF output signal

- UHF channels 21 to 69

Aerial out

- 75-ohm asymmetrical aerial socket

Tape speed

- SP: PAL 23.39 mm/s (recording/playback)
- NTSC*1 33.35 mm/s (playback only)
- LP*2: PAL 11.70 mm/s (recording/playback)
- NTSC 16.67 mm/s (playback only)
- EP*2: NTSC 11.12 mm/s (playback only)

Maximum recording/playback time

- 10 hrs. in LP mode (with E300 tape)

Fast-forward and rewind time

- Approx. 3 min. (with E180 tape)

Inputs and outputs

⇄ LINE-1 (TV)

- 21-pin
- Video input: pin 20
- Audio input: pins 2 and 6
- Video output: pin 19
- Audio output: pins 1 and 3

DECODER/⇄ LINE-2 IN (SLV-SE250D/P, SX250D, SE450D/P)

- 21-pin
- Video input: pin 20
- Audio input: pins 2 and 6

DECODER/⇄ LINE-3 IN (SLV-SE300D1/D2, SE480D)

- 21-pin
- Video input: pin 20
- Audio input: pins 2 and 6

LINE-2 IN (SLV-SE300D1/D2, SE480D)

- VIDEO IN, phono jack (1)
- Input signal: 1 Vp-p, 75 ohms, unbalanced, sync negative
- AUDIO IN, phono jack (1)
- Input level: 327 mVrms
- Input impedance: more than 47 kilohms

General

Power requirements

- 220 – 240 V AC, 50 Hz

Power consumption

- 18 W

Operating temperature

- 5°C to 40°C

Storage temperature

- 20°C to 60°C

Dimensions

- Approx. 355 × 96 × 285 mm (w/h/d)
- including projecting parts and controls

Mass

- Approx. 3.6 kg

Supplied accessories

Remote commander (1)

R6 (size AA) batteries (2)

Aerial cable (1)

Design and specifications are subject to change without notice.

*1 SLV-SE100A1/A2 cannot play NTSC-recorded tapes.

*2 not available on SLV-SE100A1/A2 and SE200V1/V2

Display window

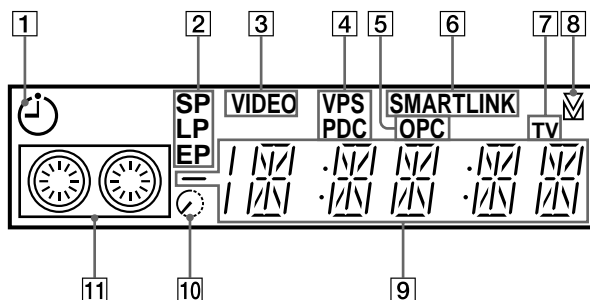

- | | |
|---|--|
| 1 Timer indicator (50) (55) (59) | 6 SMARTLINK indicator* ³ (11) |
| 2 Tape speed indicators* ¹ (45) | 7 TV indicator* ³ (47) |
| 3 VIDEO indicator (10) (45) | 8 Tracking indicator (72) |
| 4 VPS (Video Programme System)/PDC (Programme Delivery Control) indicator* ² (55) | 9 Time counter/clock/line/programme position indicator (42) (45) (78) |
| 5 OPC (Optimum Picture Control) indicator (72) | 10 Remaining time indicator (45) |
| | 11 Tape/recording indicator (45) |

*¹ LP and EP is not available on SLV-SE100A1/A2 and SE200V1/V2

*² not available on SLV-SE100A1/A2, SE250P, and SE450P

*³ not available on SLV-SE100A1/A2

continued

Rear panel

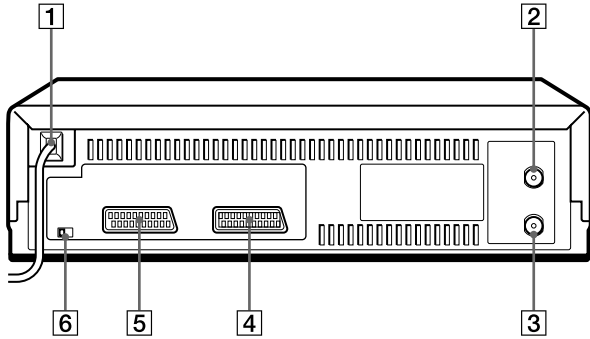

1 Mains lead (9) (10)

2 AERIAL IN
ANTENNE ENTREE connector (9) (10)

3 AERIAL OUT
ANTENNE SORTIE connector (9) (10)

4 DECODER/↔ LINE-2 IN
DECODEUR/↔ ENTREE LIGNE-2
connector*1 (36) (77)

DECODER/↔ LINE-3 IN
DECODEUR/↔ ENTREE LIGNE-3
connector*2 (12) (36) (64) (77)

5 ↔ LINE-1 (TV)
↔ LIGNE-1 (TV) connector (10) (36)

6 NTSC PB (Play Back) switch*3 (42)

*1 SLV-SE250D/P, SX250D, and SE450D/P only

*2 SLV-SE300D1/D2 and SE480D only

*3 not available on SLV-SE100A1/A2

Remote commander

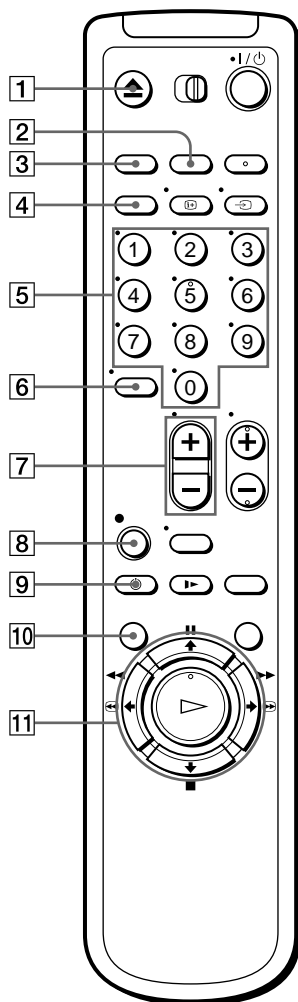

- 1 ▲ EJECT button (42)
- 2 COUNTER/REMAIN button (45)
- 3 CLEAR button (42) (54) (68)
- 4 SP (Standard Play)/LP (Long Play) button* (45)
- 5 Programme number buttons (6) (46)
- 6 -/- (ten's digit) button (6) (46)
- 7 ▲ (volume) +/- buttons (for TV) (6)
- 8 ● REC (record) button (45) (63)
- 9 ⏸ TIMER button (54) (58)
- 10 MENU button (19) (67)
- 11 || PAUSE/↑ button (19) (42)
- STOP/↓ button (19) (42)
- ◀◀ ◀ REW (rewind)/← button (42) (61)
- ▶▶ ▶ FF (fast-forward)/→ button (42) (61)
- ▷ PLAY/OK button (19) (42)

* not available on SLV-SE100A1/A2 and SE200V1/V2

continued

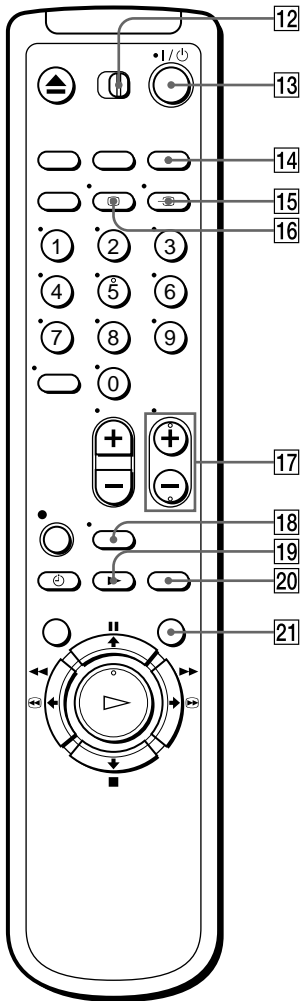

12 TV / VIDEO remote control switch (5)

13 I/⏻ (on/standby) switch (6) (55)

14 INPUT SELECT button (46) (58) (78)

15 TV/VIDEO button (6) (10) (45)

16 [+] DISPLAY button (45)

17 PROG (programme) +/- buttons (6) (27) (45)

18 WIDE button (for TV) (7)

19 ▶ SLOW button (62)

20 ×2 button* (62)

21 SMART SEARCH button (69)

* not available on SLV-SE100A1/A2 and SE200V1/V2

Index

A

Adjusting
 picture 29, 72
 tracking 72

Aerial hookup 9

AFT (Auto Fine Tuning) 29

Auto Clock Set 22

Auto Long Play 74

Auto Set Up 16

C

Canal Plus 36

Changing the programme
 position 30

Changing the station name 34

Cleaning the video heads 79

Clock setting 19

Colour system

 compatible colour systems
 2

 setting 42

Connecting

 the VCR and your TV 9, 10
 to a satellite tuner 12
 to a TV with a Scart
 (EURO-AV) connector 10

Counter 42

D

Demonstration 52

Dial Timer 48

Disabling the programme

 positions 32

Dubbing. *see* Editing

E

Editing 76

EP mode 43

L

Language selecting 24

LP mode 45

O

OPC (Optimum Picture
 Control) 72

Optional setting 74

P

PAY-TV 36

PDC (Programme Delivery
 Control) 55

Picture adjustment. *See*
 Adjusting

Playback 41

 at various speeds 61
 frame-by-frame 62
 slow motion 62

Power save 75

Presetting channels 26

R

Recording 44

 duration time 63

 saving 46

 timer setting 57

 using the Dial Timer 48

 using the ShowView

 system 53

 what you are watching on
 the TV 47

 while watching another
 programme 45

RF channel 13, 15

S

Safety tab 46

Scart connection 10

Searching

 at various speeds 61

 using the Smart Search
 function 69

ShowView

 recording 53

Smart Search 69

SMARTLINK

 Automatic Power Off 11

 One Touch Menu 11

 One Touch Play 11, 43

 One Touch Timer 11

 Preset Download 11

 TV Direct Rec 11, 47

SP mode 45

Synchronized Recording 64

T

Timer setting 57

 cancelling 67

 changing 67

 checking 67

 daily/weekly recording 55,
 59

 using the Dial Timer 48

 using the ShowView

 system 53

Tracking adjustment. *See*

 Adjusting

V

VPS (Video Programme
 System) 55