

# Video Cassette Player

## Operating Instructions



### SLV-GA59ME/SG

© 2004 Sony Corporation

## Warning

To prevent fire or shock hazard, do not expose the unit to rain or moisture.

To avoid electrical shock, do not open the cabinet. Refer servicing to qualified personnel only.

To prevent fire or shock hazard, do not place objects filled with liquids, such as vases, on the apparatus.

The mains lead must only be changed at a qualified service shop.

## Precautions

### Safety

- This unit operates on 110 – 240 V AC, 50/60 Hz. Check that the unit's operating voltage is identical with your local power supply.
- If anything falls into the cabinet, unplug the unit and have it checked by qualified personnel before operating it any further.
- The unit is not disconnected from the mains as long as it is connected to the mains, even if the unit itself has been turned off.
- Unplug the unit from the mains if you do not intend to use it for an extended period of time. To disconnect the lead, pull it out by the plug, never by the lead.

### Installing

- Do not install this equipment in a confined space such as a book or similar unit.
- Allow adequate air circulation to prevent internal heat buildup.
- Do not place the unit on surfaces (rugs, blankets, etc.) or near materials (curtains, draperies) that may block the ventilation slots.
- Do not install the unit near heat sources such as radiators or air ducts, or in a place subject to direct sunlight, excessive dust, mechanical vibration or shock.

## Getting Started

### Step : 1 Unpacking

Check that you have received the following items with the unit:

- Remote commander

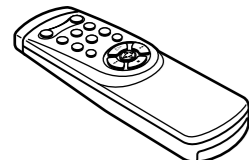

- R6 (Size AA) batteries

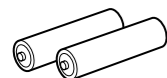

- 75-Ohm coaxial cable with F-type connectors

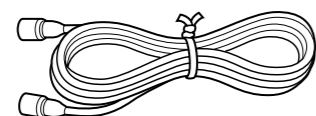

### Step 2 : Setting up the remote commander

#### Inserting the batteries

Insert two R6 (size AA) batteries by matching the + and – on the batteries to the diagram inside the battery compartment.

Insert the negative (–) end first, then push in and down until the positive (+) end clicks into position.

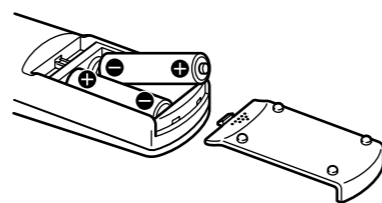

#### Using the remote commander

To operate the unit, point at the remote sensor on Remote sensor on the unit.

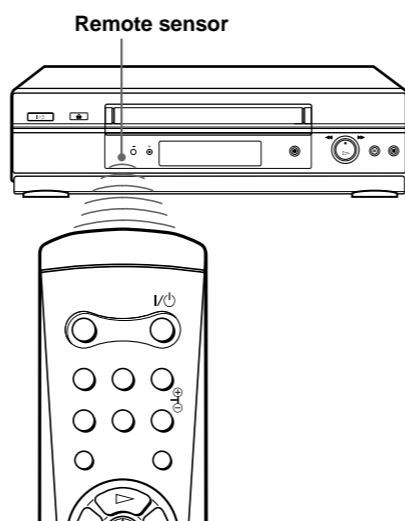

#### Notes

- With normal use, the batteries should last about three to six months.
- If you do not use the remote commander for an extended period of time, remove the batteries to avoid possible damage from battery leakage.
- Do not use a new battery together with an old one.
- Do not use different types of batteries together.

### Step 4 : Setting up the unit

Before using the unit for the first time, set up the unit.

- Connect the mains lead to the mains. Turn on your TV and the unit.

Tune the TV to channel 32 (the initial RF channel for this unit). Refer to your TV manual for TV tuning instructions.

- If the picture does not appear clearly on the TV, press MENU, then press ▲/▼/◀/▶ to highlight INSTALLATION and press OK. Then press ▲/▼ to highlight VCR OUTPUT CH and press ►. Select the RF channel by pressing the ◀/▶ buttons. Then, tune the TV to the new RF channel so that a clear picture appears.

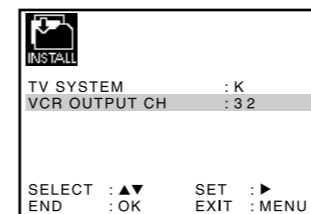

- Press MENU, then press ▲/▼/◀/▶ to highlight LANGUAGE SET and press OK. Press ◀/▶ to highlight the desired language, ENGLISH or ARABIC, then press OK.

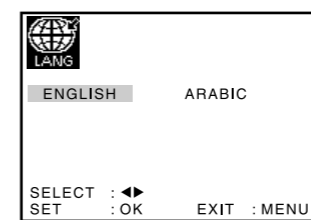

#### To set the colour system

If the playback picture has no colour, or streaks appear during playback, set COLOUR SYSTEM in the USER SET menu to conform to the system that the tape was recorded in (see "Changing menu options"). (Normally set the option to AUTO.)

**To view the tape status on the screen**  
Press DISPLAY. The following information appears on the TV screen.

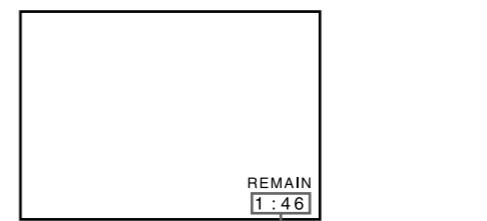
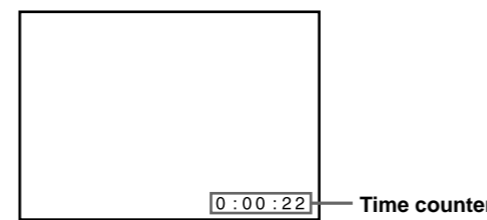

To turn the display off, press DISPLAY again.

#### Notes

- The sound is muted during playback at various speeds and pause.
- You can eject a tape even when the power is off. When you press ▲EJECT, the unit turns on automatically. After ejecting the tape, the unit turns off again.
- The counter resets to "0:00:00" whenever a tape is inserted.
- The counter stops counting when it comes to a portion with no recording.
- If a tape has portions recorded in both PAL and NTSC systems, the time counter reading will not be correct. This is due to the difference between the counting cycles of the two color systems.
- If antenna hookup is used, the following will occur while playing a PAL or MESECAM-recorded tape:
  - the picture is black and white.
  - the sound is distorted (noisy sound).
- Streaks or snow cannot be eliminated completely in the various playback operations.
- On screen symbols may shake while playing or searching at various speeds.

## Operations

### Playing/searching at various speeds

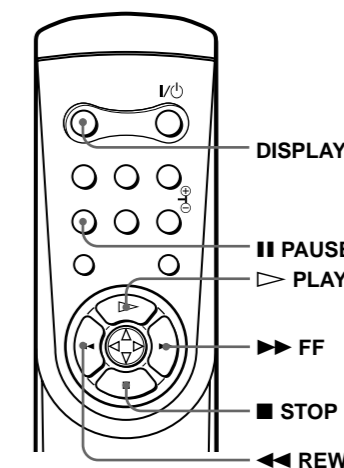
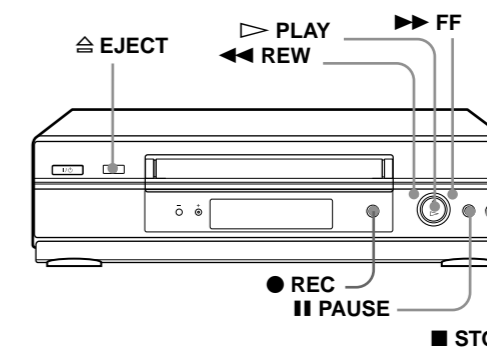

- Press ► PLAY.

When the tape reaches the end, it will rewind automatically.

#### Playback options

To	Do this
Stop play	Press ■ STOP.
Pause play	Press ▢ PAUSE.
Resume play after pause	Press ▢ PAUSE or ► PLAY.
Fast-forward the tape	Press ►► FF during stop.
Rewind the tape	Press ◀◀ REW during stop.
View the picture during fast-forward or rewind	During fast-forward, hold ►► FF down. During rewind, hold ◀◀ REW down.
Play at high speed	<ul style="list-style-type: none"> <li>During playback, briefly press ►► FF or ◀◀ REW.</li> <li>During playback, hold down ►► FF or ◀◀ REW. When you release the button, normal playback resumes.</li> </ul>
Eject the tape	Press ▲ EJECT on the unit.
Resume normal playback	Press ► PLAY.

- Turn on your TV and set it to the video channel.

- Insert a tape.

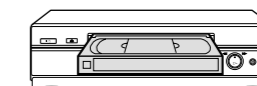

The unit turns on, and starts playing automatically if you insert a tape with its safety tab removed.

#### Using Playback Dial on the VCR

With Playback Dial, you can operate the following playback options.

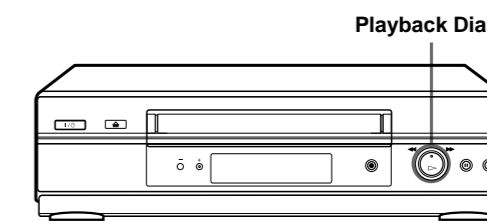

To	Do this
Resume play after pause	Press ► PLAY.
Fast-forward the tape	Quickly turn and release Playback Dial to the right (►► FF) during stop.
Rewind the tape	Quickly turn and release Playback Dial to the left (◀◀ REW) during stop.
View the picture during fast-forward or rewind	During fast-forward, turn and hold Playback Dial to the right (►► FF). During rewind, turn and hold Playback Dial to the left (◀◀ REW).

- |                    |  |
|--------------------|--|
| Play at high speed | <ul style="list-style-type: none"> <li>During playback, quickly turn and release Playback Dial to the right (►► FF) or left (◀◀ REW). The tape continues to play at high speed.</li> <li>During playback, turn and hold Playback Dial to the right (►► FF) or left (◀◀ REW). When you release Playback Dial, normal playback resumes.</li> </ul> |
|--------------------|--|

#### Tip

- Adjust the picture using the TRACKING +/- buttons on the VCR if:
  - Streaks appear while playing in slow motion.
  - Bands appear at the top or bottom while pausing.
  - The picture shakes while pausing.
- To set tracking to the centre position, press both buttons (+/-) at the same time.

#### Notes

- The sound is muted during these operations.
- In the LP mode, noise may appear or there may be no colour.
- If the playback mode mark does not appear on the TV screen, press DISPLAY.
- The picture may show noise when playing at high speed in reverse.
- Do not turn Playback Dial forcibly. It may damage Playback Dial.

## Adjusting the picture

### Adjusting the tracking

Although the unit automatically adjusts the tracking when playing a tape, distortion may occur if the recording is in poor condition. In this case, manually adjust the tracking.

During playback, press TRACKING +/- to display the tracking meter. The distortion should disappear as you press one of the two buttons. To resume automatic tracking adjustments, eject the tape and re-insert it.

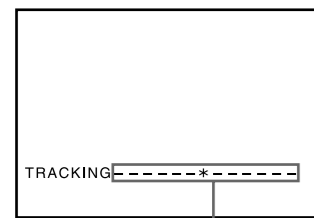

Tracking meter

### Adjusting the picture sharpness (Auto Sharpness Control)

You can automatically adjust the sharpness of the picture.

**1** During playback, press MENU, then press ▲/▼/◀/▶ to highlight USER SET and press OK.

**2** Press ▲/▼ to highlight ASC, then press ▶.

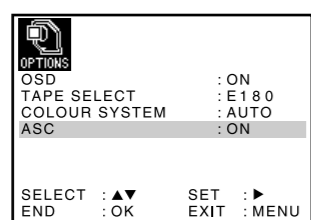

**3** Press ▲/▼ to set ASC to ON or OFF.

- ON: Picture sharpness is automatically adjusted.
- OFF: Adjust the picture sharpness manually.

To soften the picture, press ◀.

To sharpen the picture, press ▶.

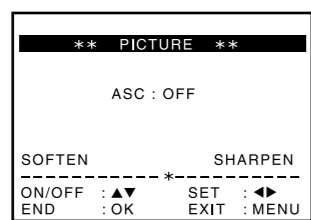

**4** Press MENU to return to the original screen.

### Editing (when recording on this unit)

You can make a copy of a tape using this unit for recording or playback. The unit cannot record TV programs directly since it does not have a TV tuner.

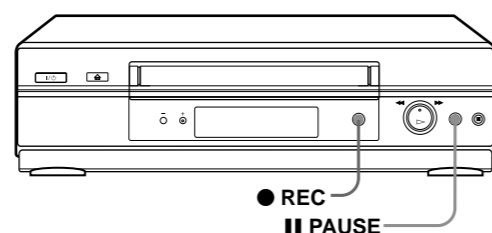

#### Before you start editing

- Turn on your TV and set it to the video channel.

**1** Press REC SPEED to select the tape speed (SP or LP for the PAL color system, and SP or EP for the NTSC color system).

LP provides a recording time twice as long as SP. EP provides a recording time three times as long as SP.

However, SP produces better picture quality.

**2** Insert a source tape with its safety tab removed into the other (playback) VCR. Search for the point to start playback and set it to playback pause.

**3** Insert a tape with its safety tab in place into this (recording) unit. Search for the point to start recording and press **II PAUSE**.

**4** Press ● REC on this unit to set it to recording pause.

**5** To start editing, press the **II PAUSE** buttons on both units at the same time.

#### To stop editing

Press the **■ STOP** buttons on both units.

#### To check the remaining tape length

Press DISPLAY. The white bar indicates the approximate length of the tape recording.

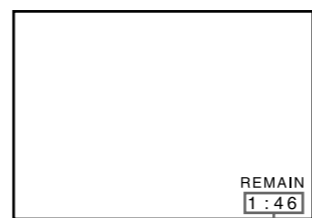

Remaining tape length

To turn the display off, press DISPLAY again.

#### To save a recording

To prevent accidental erasure, break off the safety tab as illustrated. To record on a tape again, cover the tab hole with adhesive tape.



Safety tab

#### Tips

- To edit more precisely, press the **II PAUSE** buttons on the units to release pause.
- To cut out unwanted scenes while editing, press **II PAUSE** on this unit when an unwanted scene begins. When that scene ends, press **II PAUSE** again to resume recording.

## Changing menu options

**1** Press MENU, then press ▲/▼/◀/▶ to highlight USER SET and press OK.

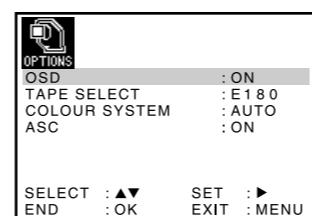

**2** Press ▲/▼ to select the option.

**3** Press ▶ to change the setting, then press OK.

### Menu choices

Initial settings are indicated in bold print.

#### USER SET

Menu option	Set this option to
OSD	• <b>ON</b> to display the menu on the TV screen. • OFF to disappear the menu from the TV screen.

TAPE SELECT	• <b>E180</b> to use an E-180 or shorter type tape. • E240 to use an E-240 type tape. • E260 to use an E-260 type tape. • E300 to use an E-300 type tape.
-------------	--

COLOUR SYSTEM	• <b>AUTO</b> to select the colour system automatically. • PAL to use the tape recorded in the PAL colour system. • MESECAM to use the tape recorded in the MESECAM colour system. • B/W to use the tape recorded in black and white.  When using the tape recorded NTSC colour signals: • <b>NT3.58</b> to use the tape recorded in the NTSC 3.58 colour system. • NT4.43 to use the tape recorded in the NTSC 4.43 colour system.
---------------	--

ASC	• <b>ON</b> to automatically adjust the sharpness of the picture. • OFF to manually adjust the sharpness of the picture.
-----	---

Symptom	Remedy
A tape cannot be inserted.	• Check that a tape is not already in the tape compartment.
The remote commander does not function.	• Make sure you are pointing the remote commander at the remote sensor on the unit. • Replace all the batteries in the remote commander with new ones if they are weak.
The tracking meter does not appear on the TV screen.	• The recording condition of the tape is very poor and tracking cannot be adjusted.
The unit needs to be cleaned.	• Clean the cabinet, panel, and controls with a dry soft cloth, or a soft cloth slightly moistened with a mild detergent solution. Do not use any type of solvent, such as alcohol or benzene.

### Auto head cleaner

The unit incorporates an auto head cleaner which cleans the video heads when a tape is loaded or unloaded. When the heads are not sufficiently clean, even after a tape has been loaded/unloaded several times, use a video head cleaning cassette.

#### Symptoms caused by contaminated video heads

- Normal picture
- Rough picture
- Unclear picture
- No picture (or black & white screen appears)



initial contamination

terminal

## Editing with another unit

### Connections necessary to record on this unit

#### Tip

- Use Sony's commercially available connecting cable. If the other VCR has the AUDIO L and R jacks, use a Sony connecting cable (3-phono to 2-phono).

#### Notes

- Make sure you connect the plugs to jacks of the same color.
- If you connect this unit to both the LINE IN and LINE OUT jacks of the other VCR, select the input correctly to prevent a humming noise.
- Make sure you set the CONNECT LINE-1 switch to OTHERS.

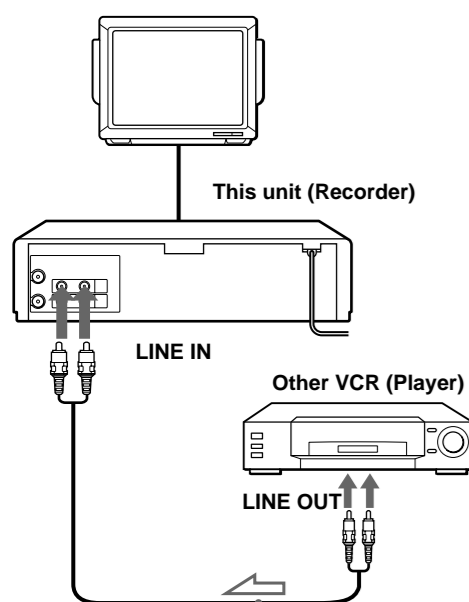

Audio/video cable (not supplied)

Signal flow

## Setting the recording duration time

After you have started recording in the normal way, you can have the unit stop recording automatically after a specified duration.

**1** While recording, press ● REC.

Recording duration time appears on the TV screen.

**2** Press ● REC repeatedly to set the duration time.

In SP mode

Each press advances the time in increments of 30 minutes.

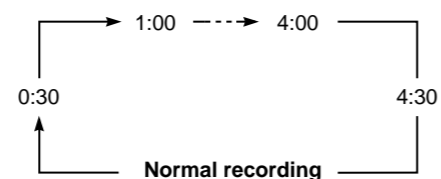

In LP (EP) mode

Each press advances the time as shown below.

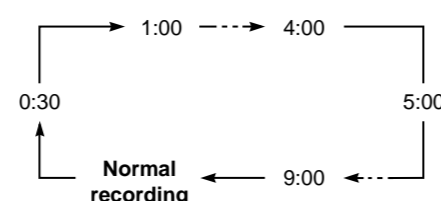

The tape counter decreases minute by minute to 0:00, then the unit stops recording and turns off automatically.

#### To extend the duration

Press ● REC repeatedly to set a new duration time.

#### To view the duration time

Press DISPLAY. The following information appears on the TV screen.

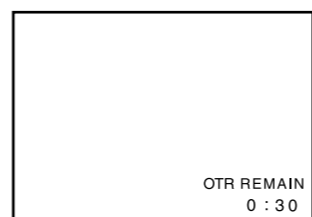

#### To cancel the duration

Press ● REC repeatedly and the unit returns to the normal recording mode.

#### To stop recording

To stop the unit while recording, press **■ STOP**.

#### Additional information

## Troubleshooting

If you have any questions or problems not covered below, please consult your nearest Sony service facility.

Symptom	Remedy
<b>Power</b> The I/ON/STANDBY switch does not function.	• Connect the mains lead to the mains securely.
The power is turned on but the unit does not operate.	• Moisture condensation has occurred. Turn the power off, unplug the mains lead and leave the unit to dry or over three hours.
The playback picture does not appear on the TV screen.	• Make sure the TV is set to the video channel. If you are using a monitor, set it to video input.
The picture is not clear.	• Adjust the tracking with the TRACKING +/- buttons. • The video heads are dirty (see "Symptoms caused by contaminated video heads"). Clean the video heads using a Sony video head cleaning cassette. If a Sony cleaning cassette is not available in your area, have the heads cleaned at your nearest Sony service facility (a standard service charge will be required). Do not use a commercially available liquid type cleaning cassette, as it may damage the video heads. • The video heads may have to be replaced. Consult your local Sony service facility for more information.
The picture has no colour.	• The COLOUR SYSTEM option in the USER SET menu is set to the wrong position. Set the option to conform to the system that the tape was recorded in.
The picture rolls vertically during picture search.	• Adjust the vertical hold control on the TV or monitor.
The picture has no sound.	• The tape is defective. • If you made A/V connections, check the audio cable connection. • If you made connections using the aerial cable only, make sure the TV system is set correctly for your area.
<b>Playback</b> The recorded picture has no colour or unusual colour.	• Set COLOUR SYSTEM in the USER SET menu according to your local colour system.
The tape starts playing as soon as it is inserted.	• The safety tab has been removed. To record on this tape, cover the tab hole.
The tape is ejected when you press ● REC.	• Check that the safety tab has not been removed.
Nothing happens when you press ● REC.	• Make sure the tape is not at its end.
<b>Recording</b> The recorded picture has no colour or unusual colour.	• Set COLOUR SYSTEM in the USER SET menu according to your local colour system.
The tape starts playing as soon as it is inserted.	• The safety tab has been removed. To record on this tape, cover the tab hole.
The tape is ejected when you press ● REC.	• Check that the safety tab has not been removed.
Nothing happens when you press ● REC.	• Make sure the tape is not at its end.

#### TV system

## Specifications

System	General
Color system PAL, MESECAM, NTSC 3.58, NTSC 4.43 G, K, I	Power requirements 110 - 240 V AC, 50/60 Hz
Tape speed SP: PAL 23.39 mm/s NTSC 33.35 mm/s LP: PAL 11.70 mm/s NTSC 16.67 mm/s (playback only) EP: NTSC 11.12 mm/s	Power consumption 10 W Operating temperature 5 °C to 40 °C Storage temperature -20 °C to 60 °C
Maximum playback time 10 hrs. in LP mode (with E300 tape)	Dimensions including projecting parts and controls Approx. 360 × 95 × 245 mm (w/h/d)
Fast-forward and rewind time Approx. 1 min. (with E180 tape)	Mass Approx. 2.8 kg
Tuner section RF output signal UHF channels 21 to 69 (G/K/I)	Supplied accessories Remote commander (1) R6 (Size AA) batteries (2) 75-ohm coaxial cable with F-type connectors (1)
Aerial out 75-ohm asymmetrical aerial socket	Design and specifications are subject to change without notice.
Inputs and outputs LINE IN VIDEO IN, phono jack (1) Input signal: 1 Vp-p, 75 ohms, unbalanced, sync negative AUDIO IN, phono jack (1) Input level: 327 mVrms Input impedance: more than 47 kilohms	
LINE OUT VIDEO OUT, phono jack (1) Output signal: 1 Vp-p, 75 ohms, unbalanced, sync negative AUDIO OUT, phono jack (1) Standard output: 327 mVrms Load impedance: 47 kilohms Output impedance: less than 10 kilohms	