

Video Cassette Recorder

Operating Instructions



SLV-EZ727AZ		Hi-Fi	G-CODE®
SLV-EZ725AZ		Hi-Fi	
SLV-EZ424AZ			G-CODE®
SLV-EZ121AZ			

WARNING

To prevent fire or shock hazard, do not expose the unit to rain or moisture.

To avoid electrical shock, do not open the cabinet. Refer servicing to qualified personnel only.

The mains lead must only be changed at a qualified service shop.

Precautions

Safety

- This unit operates on 220 – 240 V AC, 50 Hz. Check that the unit's operating voltage is identical with your local power supply.
- If anything falls into the cabinet, unplug the unit and have it checked by qualified personnel before operating it any further.
- The unit is not disconnected from the mains as long as it is connected to the mains, even if the unit itself has been turned off.
- Unplug the unit from the mains if you do not intend to use it for an extended period of time. To disconnect the lead, pull it out by the plug, never by the lead.
- To prevent fire or shock hazard, do not place objects filled with liquids, such as vases, on the apparatus.

Installing

- Allow adequate air circulation to prevent internal heat buildup.
- Do not place the unit on surfaces (rugs, blankets, etc.) or near materials (curtains, draperies) that may block the ventilation slots.
- Do not install the unit near heat sources such as radiators or air ducts, or in a place subject to direct sunlight, excessive dust, mechanical vibration or shock.
- Do not install the unit in an inclined position. It is designed to be operated in a horizontal position only.
- Keep the unit and cassettes away from equipment with strong magnets, such as microwave ovens or large loudspeakers.
- Do not place heavy objects on the unit.

- If the unit is brought directly from a cold to a warm location, moisture may condense inside the VCR and cause damage to the video head and tape. When you first install the unit, or when you move it from a cold to a warm location, wait for about four hours before operating the unit.

Caution

Television programmes, films, video tapes and other materials may be copyrighted. Unauthorized recording of such material may be contrary to the provisions of the copyright laws. Also, use of this recorder with cable television transmission may require authorization from the cable television transmitter and/or programme owner.

Compatible colour/TV systems

- Check the colour systems of your VCR using the table below.

Model number	Colour system	
	Recording	Playback
SLV-EZ727AZ	PAL (B/G and B/B) NTSC 4.43 NTSC 3.58	PAL (B/G and B/B) NTSC 4.43 NTSC 3.58
SLV-EZ725AZ, EZ424AZ and EZ121AZ	PAL (B/G and B/B)	PAL (B/G and B/B) NTSC 4.43

Recording of video sources based on other colour systems cannot be guaranteed.

For SLV-EZ727AZ

- NTSC colour signals can only be recorded through the line inputs.

G-CODE is a registered trade mark of Gemstar Development Corporation. The G-CODE system is manufactured under license from Gemstar Development Corporation.

Table of Contents

Getting Started

- 4 Index to parts and controls
- 10 Step 1 : Unpacking
- 11 Step 2 : Setting up the remote commander
- 14 Step 3 : Connecting the VCR
- 16 Step 4 : Setting up the VCR with the Auto Set Up function
- 18 Step 5 : Setting the clock
- 20 Step 6 : Selecting the TV system
- 21 Step 7 : Presetting channels with the EASY G-CODE SET UP function (SLV-EZ727AZ and EZ424AZ only)
- 22 Presetting channels
- 25 Changing/disabling programme positions

Basic Operations

- 30 Playing a tape
- 32 Recording TV programmes
- 36 Recording TV programmes using the Easy Timer
- 42 Recording TV programmes using the G-CODE® system (SLV-EZ727AZ and EZ424AZ only)
- 45 Recording TV programmes using the timer

Additional Operations

- 48 Playing/searching at various speeds
- 49 Setting the recording duration time
- 50 Checking/changing/cancelling timer settings
- 52 Recording stereo and bilingual programmes (SLV-EZ727AZ and EZ725AZ only)
- 55 Searching using the index function
- 56 Adjusting the picture
- 57 Reducing the VCR's power consumption
- 58 Changing menu options

Editing

- 60 Connecting to a VCR or stereo system
- 62 Basic editing

Additional Information

- 63 Troubleshooting
- 67 Specifications

Back cover

Index

Index to parts and controls

Refer to the pages indicated in parentheses () for details.

Front panel

For SLV-EZ727AZ and EZ725AZ

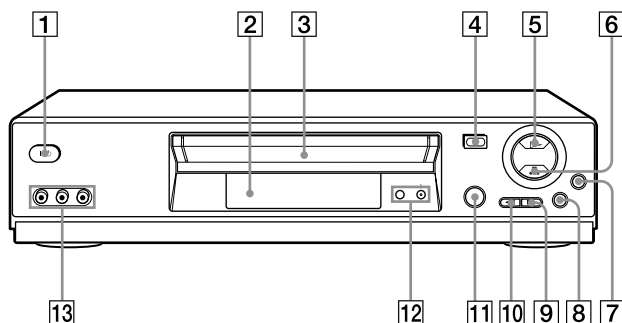

1 I/⏻ ON/STANDBY switch

2 Remote sensor (11)

3 Tape compartment

4 ⏏ EJECT button (30)

5 ▷ PLAY button* (30) (48)

6 ■ STOP button* (17) (30) (62)

7 ● REC (record) button (33) (49) (62)

8 || PAUSE button (30) (41) (62)

9 ►► FF (fast-forward) button (30) (48)

10 ◀◀ REW (rewind) button (30) (48)

11 EASY TIMER (36)

12 PROGRAM/TRACKING +/- buttons* (37) (56)

13 LINE-2 IN VIDEO/AUDIO L/R (left/right) jacks (60) (61)

* The ▷ PLAY, ■ STOP and PROGRAM/TRACKING +/- buttons have a tactile dot.

For SLV-EZ424AZ and EZ121AZ

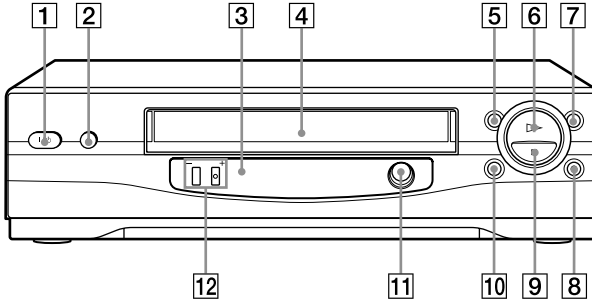

- 1** I/⏻ ON/STANDBY switch
- 2** ≡ EJECT button (30)
- 3** Remote sensor (11)
- 4** Tape compartment
- 5** ◀◀ REW (rewind) button (30) (48)
- 6** ▷ PLAY button (30) (48)
- 7** ▶▶ FF (fast-forward) button (30) (48)
- 8** ● REC (record) button (33) (49) (62)
- 9** ■ STOP button (17) (30) (62)
- 10** || PAUSE button (30) (41) (62)
- 11** EASY TIMER (36)
- 12** PROGRAM/TRACKING +/- buttons* (37) (56)

* The PROGRAM/TRACKING + button has a tactile dot.

continued

Index to parts and controls (continued)

Display window

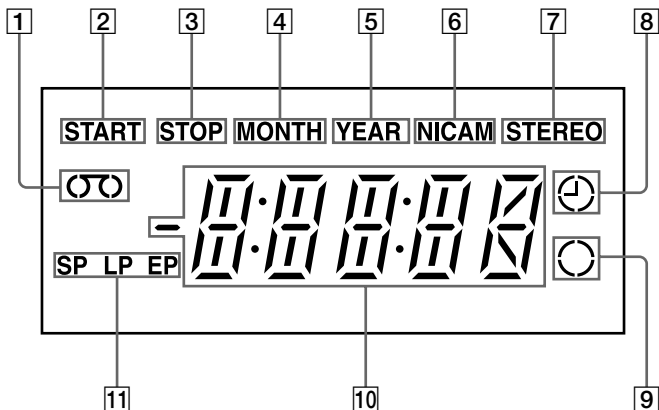

1 Tape indicator

2 START indicator (37)

3 STOP indicator (37)

4 MONTH indicator (40)

5 YEAR indicator

6 NICAM indicator* (53)

7 STEREO indicator* (52)

8 Timer indicator (39) (43) (46)

9 Recording indicator (33)

10 Time counter/clock/line/programme position indicator (31) (32) (62)

11 Tape speed indicators (32) (38)

* SLV-EZ727AZ and EZ725AZ only

Rear panel

For SLV-EZ727AZ and EZ725AZ

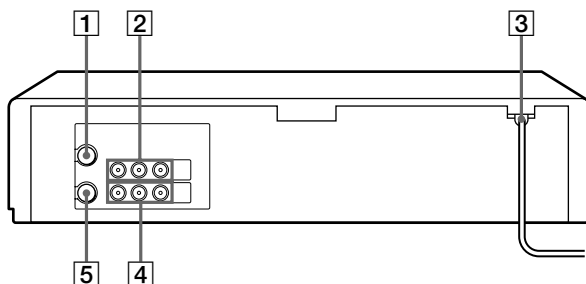

For SLV-EZ424AZ and EZ121AZ

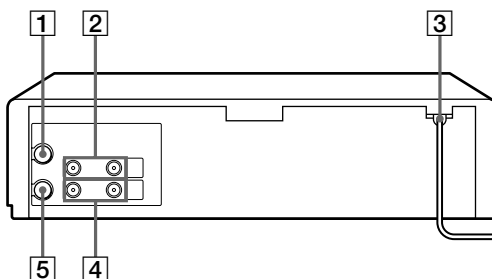

- 1** Υ (in from antenna) connector (14)
- 2** LINE IN 1 AUDIO R/L/VIDEO (audio right/audio left/video) jacks*¹ (61)
LINE IN 2 AUDIO/VIDEO jacks*² (60)
- 3** Mains lead (14)

- 4** LINE OUT AUDIO R/L/VIDEO (audio right/audio left/video) jacks*¹
LINE OUT AUDIO/VIDEO jacks*² (15)
- 5** \square (out to tv) connector (14)

*¹ SLV-EZ727AZ and EZ725AZ only

*² SLV-EZ424AZ and EZ121AZ only

continued

Index to parts and controls (continued)

Remote commander

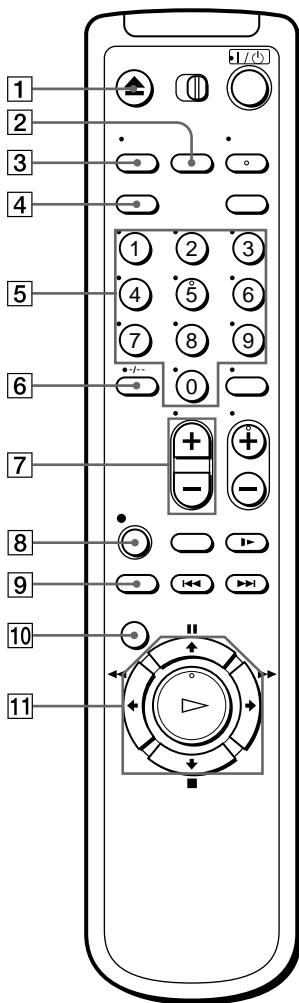

- 1** ▲ EJECT button (30)
- 2** INPUT SELECT button (32) (45) (62)
- 3** TV/VIDEO button (*for TV*)
- 4** CLEAR button (31) (42) (50)
- 5** Programme number buttons* (42)
- 6** -/-- (ten's digit) button
- 7** VOL (volume) +/- buttons
- 8** ● REC (record) button (33) (49)
- 9** REC SPEED (recording speed) button (32)
- 10** MENU button (22) (50)
- 11** || PAUSE/▲ button (22) (30)
■ STOP/▼ button (22) (30)
◀◀ REW (rewind)/← button (22) (30) (48)
▶▶ FF (fast-forward)/→ button (22) (30) (48)
▷ PLAY/OK button* (22) (30) (48)

* The ▷ PLAY, AUDIO MONITOR, number 5 and PROG + buttons have a tactile dot.

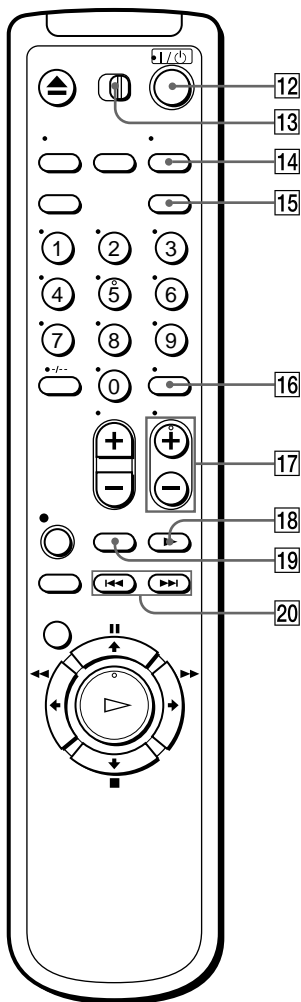

- 12** I/⏻ (on/standby) switch (43)
- 13** •TV/VIDEO remote control switch (11)
- 14** AUDIO MONITOR button*¹*² (52)
- 15** G-CODE button*³ (42)
- 16** DISPLAY button (31) (33)
- 17** PROG (programme) +/- buttons*¹ (34)
- 18** ►► SLOW button (48)
- 19** x2 button (48)
- 20** ◀◀/▶▶ INDEX SEARCH buttons (55)

*¹ The ▷ PLAY, AUDIO MONITOR, number 5 and PROG + buttons have a tactile dot.

*² not available on SLV-EZ424AZ and EZ121AZ

*³ SLV-EZ727AZ and EZ424AZ only

Step 1 : Unpacking

Check that you have received the following items with the VCR:

- Remote commander

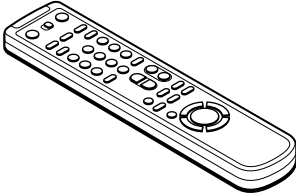

- R6 (size AA) batteries

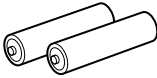

- Aerial cable

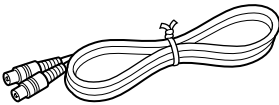

Check your model name

The instructions in this manual are for the 4 models: SLV-EZ727AZ, EZ725AZ, EZ424AZ and EZ121AZ. Check your model name by looking at the rear panel of your VCR. SLV-EZ727AZ is the model used for illustration purposes. Any difference in operation is clearly indicated in the text, for example, “SLV-EZ727AZ only.”

Step 2 : Setting up the remote commander

Inserting the batteries

Insert two R6 (size AA) batteries by matching the + and – on the batteries to the diagram inside the battery compartment.

Insert the negative (–) end first, then push in and down until the positive (+) end clicks into position.

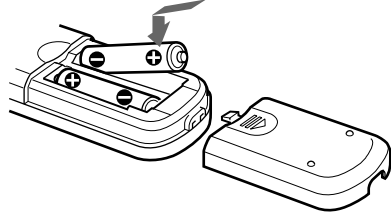

Using the remote commander

You can use this remote commander to operate this VCR and a Sony TV. Buttons on the remote commander marked with a dot (•) can be used to operate your Sony TV. If the TV does not have the  symbol near the remote sensor, this remote commander will not operate the TV.

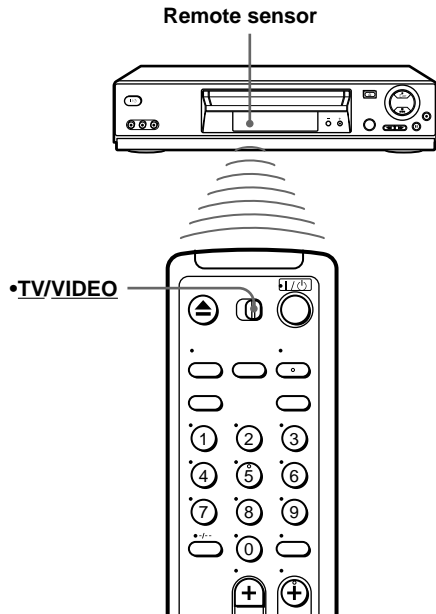

To operate	Set •TV/VIDEO to
the VCR	<u>VIDEO</u> and point at the remote sensor at the VCR
a Sony TV	•TV and point at the remote sensor at the TV

continued

Step 2 : Setting up the remote commander (continued)

Notes

- With normal use, the batteries should last about three to six months.
- If you do not use the remote commander for an extended period of time, remove the batteries to avoid possible damage from battery leakage.
- Do not use a new battery together with an old one.
- Do not use different types of batteries together.
- Some buttons may not work with certain Sony TVs.

Controlling other TVs with the remote commander (SLV-EZ727AZ only)

The remote commander is preprogrammed to control non-Sony TVs. If your TV is listed in the following table, set the appropriate manufacturer's code number.

- 1** Set **•TV/VIDEO** at the top of the remote commander to **•TV**.
- 2** Hold down **I/⏻**, and enter your TV's code number using the programme number buttons. Then release **I/⏻**.

Now you can use the following TV control buttons to control your TV: **I/⏻**, **VOL +/-**, **PROG +/-**, programme number buttons, **-/--** (ten's digit) and **TV/VIDEO**.

Code numbers of controllable TVs

If more than one code number is listed, try entering them one at a time until you find the one that works with your TV.

Manufacturer	Code number	Manufacturer	Code number
Sony	01, 02	Panasonic	17, 49
Akai	68	Philips	06, 07, 08
Ferguson	52	Saba	12, 13
Grundig	10, 11	Samsung	22, 23
Hitachi	24	Sanyo	25
JVC	33	Sharp	29
Loewe	45	Telefunken	36
Mivar	09, 70	Thomson	43
NEC	66	Toshiba	38
Nokia	15, 16, 69		

Tip

- When you set your TV's code number correctly while the TV is turned on, the TV turns off automatically.

Notes

- If you enter a new code number, the code number previously entered will be erased.
- If the TV uses a different remote control system from the one programmed to work with the VCR, you cannot control your TV with the remote commander.
- When you replace the batteries of the remote commander, the code number may change. Set the appropriate code number every time you replace the batteries.

Step 3 : Connecting the VCR

Connect the aerial to your VCR and TV as shown below to watch TV programmes and VCR pictures on your TV. In addition, if your TV has audio/video (A/V) input jacks, we recommend you connect the VCR to your TV using an audio/video cable to get a better picture and sound.

Connecting the aerial

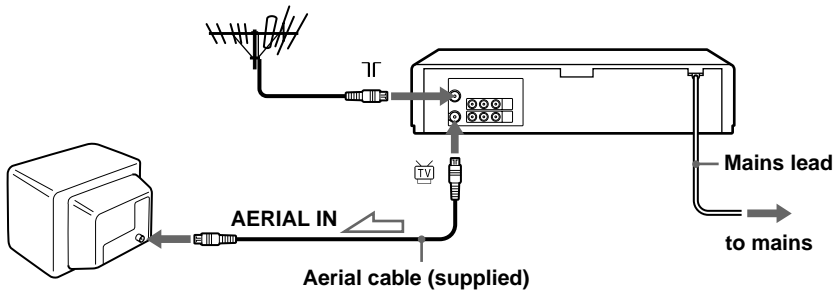

 : Signal flow

1

Disconnect the aerial cable from your TV and connect it to  on the rear panel of the VCR.

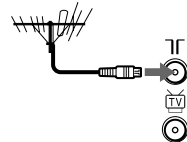

2

Connect  of the VCR and the aerial input of your TV using the supplied aerial cable.

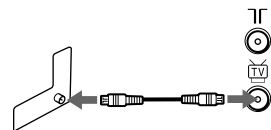

3

Connect the mains lead to the mains.

Note

- When you connect the VCR and your TV only with an aerial cable, you have to tune your TV to the VCR (see page 16).

Additional connections

To a TV that has audio/video input jacks

This additional connection improves picture and sound quality. Connect the TV as shown on the right.

For SLV-EZ727AZ and EZ725AZ

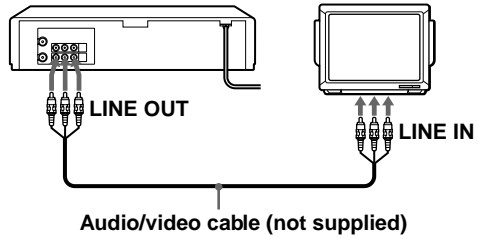

For SLV-EZ424AZ and EZ121AZ

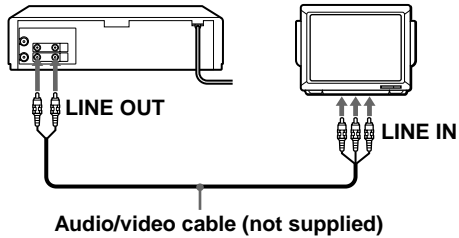

To a stereo system (SLV-EZ727AZ and EZ725AZ only)

You can improve sound quality by connecting a stereo system to the LINE OUT AUDIO R/L jacks as shown on the right.

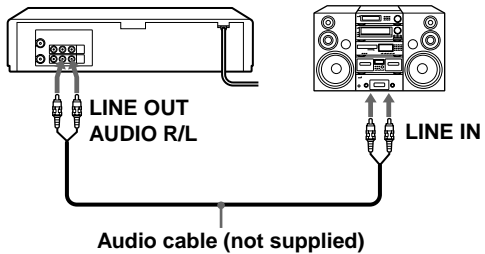

Note

- To play a tape in stereo, you must connect your VCR either to a TV with audio/video input jacks or to a stereo system as shown on above right.

Step 4 : Setting up the VCR with the Auto Set Up function

Before using the VCR for the first time, set up the VCR using the Auto Set Up function. With this function, you can set the TV channels automatically.

1 Turn on your TV and set it to the video channel.
Tune the TV to channel 68 (in Australia) or 63 (in New Zealand) (the initial RF channel for this VCR). Refer to your TV manual for TV tuning instructions. If the picture does not appear clearly, see “To change the RF channel” on page 17.

2 Connect the mains lead to the mains.
The VCR automatically turns on.
The message for the Auto Set Up function appears on the TV screen.

3 Press OK.
The SYSTEM SELECT menu appears.

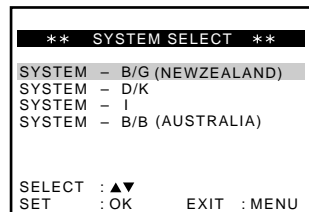

4 Press **↑/↓/←/→** to select the appropriate TV system, then press OK.



The VCR starts searching for all of the receivable channels and presets them (in the appropriate order for your local area).

If you want to change the order of the channels or disable unwanted programme positions, see “Changing/disabling programme positions” on page 25.

After the search is complete, the clock setting menu appears. See “Setting the clock” on page 18.

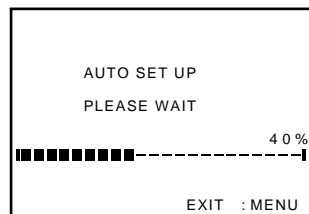

To cancel the Auto Set Up function

Press MENU.

To change the RF channel

If the picture does not appear clearly on the TV, change the RF channel on the VCR and TV. Select INSTALLATION from the menu, then press **↑/↓** to highlight VCR OUTPUT CH and press **→**. Select the RF channel by pressing the **↑/↓** buttons. Then, tune the TV to the new RF channel so that a clear picture appears.

Notes

- Whenever you operate the Auto Set Up function, some of the settings (timer, etc.) will be reset. If this happens, you have to set them again.
- Auto preset starts automatically only when you plug in the mains lead for the first time after you purchase the VCR.
- Auto preset can be performed by pressing **■ STOP on the VCR** continuously for 5 seconds or more with no tape inserted.

Step 5 : Setting the clock

You must set the time and date on the VCR to use the timer features properly.

Before you start...

- Turn on the VCR and the TV.
- Set the TV to the video channel.
- Refer to “Index to parts and controls” for button locations.

1

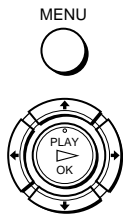

Press MENU, then press **↑/↓/←/→** to highlight CLOCK SET and press OK.

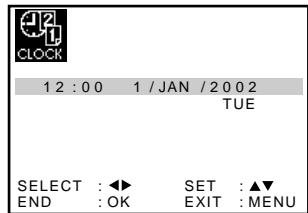

2



Press **↑/↓** to set the hour.

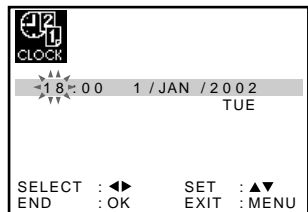

3



Press **→** to select the minutes and set the minutes by pressing **↑/↓**.

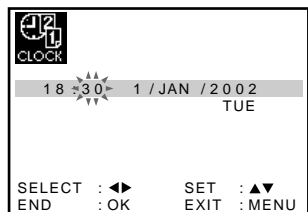

4



Set the day, month, and year in sequence by pressing **→** to select the item to be set, and press **↑/↓** to select the digits, then press **→**.

The day of the week is set automatically.

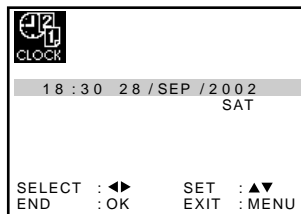

5

MENU



Press MENU to exit the menu.

Tip

- To change the digits while setting, press **←** to return to the item to be changed, and select the digits by pressing **↑/↓**.

Step 6 : Selecting the TV system

You must select the appropriate TV system for your area.

Before you start...

- Turn on the VCR and the TV.
- Set the TV to the video channel.
- Refer to “Index to parts and controls” for button locations.

1

MENU



Press MENU, then press **↑/↓/←/→** to highlight INSTALLATION and press OK.

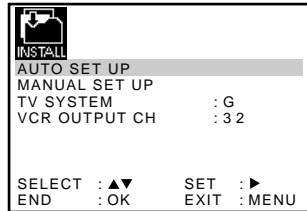

2



Press **↑/↓** to highlight TV SYSTEM, then press **→**.

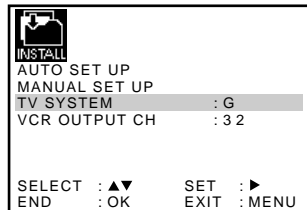

3



Press **→** to select the appropriate TV system. Select “G” in New Zealand, or “B” in Australia.

4

MENU



Press MENU to exit the menu.

Step 7 : Presetting channels with the EASY G-CODE SET UP function (SLV-EZ727AZ and EZ424AZ only)

The EASY G-CODE SET UP function is a feature that simplifies the G-CODE guide channel setting. Just choose your local area in the EASY G-CODE SET UP menu, and the VCR will automatically preset the G-CODE guide channels for your area.

Before you start...

- Turn on the VCR and the TV.
- Set the TV to the video channel.
- Set up the VCR with the Auto Set Up function.
- Refer to “Index to parts and controls” for button locations.

1 Press MENU, then press **↑/↓/←/→** to highlight EASY OPERATION and press OK.

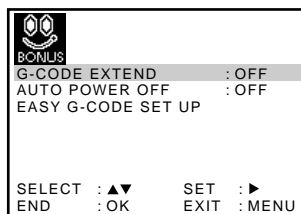
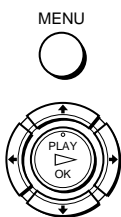

2 Press **↑/↓** to highlight EASY G-CODE SET UP, then press **→**.

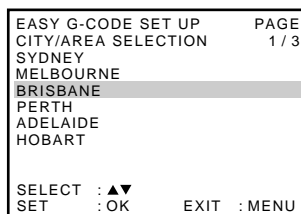

3 Press **↑/↓** to highlight your local area, then press OK to confirm the setting. To display other pages for other areas, press **↑/↓** repeatedly.



The G-CODE guide channels for your local area are set up automatically.

Note

- If you select “SYSTEM – D/K” or “SYSTEM – I” in the SYSTEM SELECT menu in step 3 of “Setting up the VCR with the Auto Set Up function” on page 16, the EASY G-CODE SET UP function does not work.

Presetting channels

If some channels could not be preset using the Auto Set Up function, you can preset them manually.

Before you start...

- Turn on the VCR and the TV.
- Set the TV to the video channel.
- Refer to “Index to parts and controls” for button locations.

1

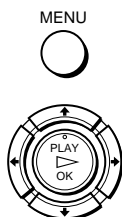

Press MENU, then press **↑/↓/←/→** to highlight INSTALLATION and press OK.

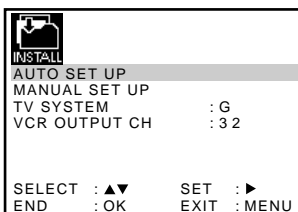

2



Press **↑/↓** to highlight MANUAL SET UP, then press **→**.

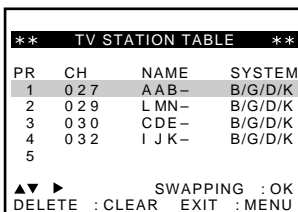

3



Press **↑/↓** to highlight the row which you want to preset, then press **→**.

To display other pages for programme positions 6 to 80, press **↑/↓** repeatedly.

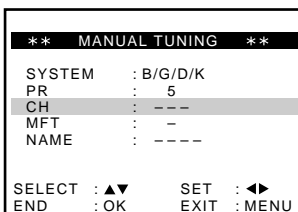

4



Press \leftarrow/\rightarrow repeatedly until the channel you want is displayed. Select the appropriate TV system, if necessary.

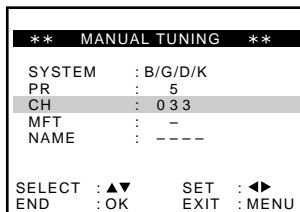

5



Press \uparrow/\downarrow to highlight NAME, then press \rightarrow .

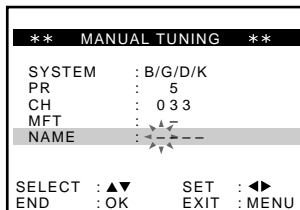

6



Enter the station name.

1 Press \uparrow/\downarrow to select a character. Each time you press \uparrow , the character changes as shown below.

A \rightarrow B \rightarrow ... \rightarrow Z \rightarrow 0 \rightarrow 1
 \rightarrow ... \rightarrow 9 \rightarrow A

2 Press \rightarrow to set the next character.

The next space flashes.

To correct a character, press \leftarrow/\rightarrow until the character you want to correct flashes, then reset it.

You can set up to 4 characters for the station name.

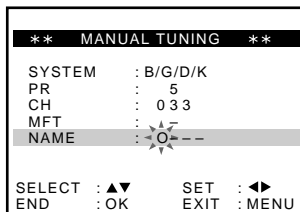

7



Press OK to confirm the station name.

8



Press MENU to exit the menu.

continued

Presetting channels (continued)

If the picture is not clear

If the picture is not clear, you may use the Manual Fine Tuning (MFT) function. After step 4, press **↑/↓** to select MFT. Press **←/→** to get a clear picture, then press MENU to exit the menu.

Notes

- If the TV sound is distorted or noisy, select the appropriate TV system (“G” or “B”) for your area (see page 20).
- When adjusting MFT, the menu may become difficult to read due to interference from the picture being received.

Changing/disabling programme positions

After setting the channels, you can change the programme positions as you like. If any programme positions are unused or contain unwanted channels, you can disable them.

You can also change the station names. If the station names are not displayed, you can enter them manually.

Changing programme positions

Before you start...

- Turn on the VCR and the TV.
- Set the TV to the video channel.
- Refer to “Index to parts and controls” for button locations.

1 Press MENU, then press **↑/↓/←/→** to highlight INSTALLATION and press OK.

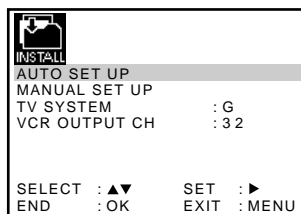
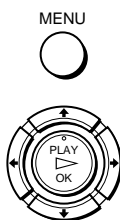

2 Press **↑/↓** to highlight MANUAL SET UP, then press **→**.



** TV STATION TABLE **			
PR	CH	NAME	SYSTEM
1	027	AAB-	B/G/D/K
2	029	LMN-	B/G/D/K
3	030	CDE-	B/G/D/K
4	032	IJK-	B/G/D/K
5			

▲▼ ► SWAPPING : OK
DELETE : CLEAR EXIT : MENU

3 Press **↑/↓** to highlight the row containing the programme position you want to change.



To display other pages for programme positions 6 to 80, press **↑/↓** repeatedly.

** TV STATION TABLE **			
PR	CH	NAME	SYSTEM
1	027	AAB-	B/G/D/K
2	029	LMN-	B/G/D/K
3	030	CDE-	B/G/D/K
4	032	IJK-	B/G/D/K
5			

▲▼ ► SWAPPING : OK
DELETE : CLEAR EXIT : MENU

continued

Changing/disabling programme positions (continued)

4



Press OK, then press **↑/↓** to move to the desired programme position.

** TV STATION TABLE **			
PR	CH	NAME	SYSTEM
1	0 2 7	A A B-	B/G/D/K
2			
3	0 3 0	C D E-	B/G/D/K
4	0 3 2	L K M-	B/G/D/K
5	0 2 9	L M N-	B/G/D/K

▲▼ SWAPPING : OK
EXIT : MENU

5



Press OK to confirm the setting.

6

To change the programme position of another station, repeat steps 3 through 5.

7



Press MENU to exit the menu.

Disabling unwanted programme positions

After presetting channels, you can disable unused programme positions. The disabled positions will be skipped later when you press the PROG +/- buttons.

Before you start...

- Turn on the VCR and the TV.
- Set the TV to the video channel.
- Refer to “Index to parts and controls” for button locations.

1



Press MENU, then press **↑/↓/←/→** to highlight INSTALLATION, and press OK.



INSTALL	
AUTO SET UP	
MANUAL SET UP	
TV SYSTEM	: G
VCR OUTPUT CH	: 3 2

SELECT : ▲▼ SET : ►
END : OK EXIT : MENU

2  Press **↑/↓** to highlight **MANUAL SET UP**, then press **→**.

** TV STATION TABLE **			
PR	CH	NAME	SYSTEM
1	0 2 7	A A B -	B/G/D/K
2	0 2 9	L M N -	B/G/D/K
3	0 3 0	C D E -	B/G/D/K
4	0 3 2	I J K -	B/G/D/K
5			

▲▼▶ SWAPPING : OK
DELETE : CLEAR EXIT : MENU

3  Press **↑/↓** to highlight the row which you want to disable.
To display other pages for programme positions 6 to 80, press **↑/↓** repeatedly.

** TV STATION TABLE **			
PR	CH	NAME	SYSTEM
1	0 2 7	A A B -	B/G/D/K
2	0 2 9	L M N -	B/G/D/K
3	0 3 0	C D E -	B/G/D/K
4	0 3 2	I J K -	B/G/D/K
5			

▲▼▶ SWAPPING : OK
DELETE : CLEAR EXIT : MENU

4  Press **CLEAR**.
The selected row will be cleared as shown on the right.

** TV STATION TABLE **			
PR	CH	NAME	SYSTEM
1	0 2 7	A A B -	B/G/D/K
2			
3	0 3 0	C D E -	B/G/D/K
4	0 3 2	I J K -	B/G/D/K
5			

▲▼▶ SWAPPING : OK
DELETE : CLEAR EXIT : MENU

5 Repeat steps 3 and 4 for any other programme positions you want to disable.

6  Press **MENU** to exit the menu.

- Note**
- Be sure to select the programme position you want to disable correctly. If you disable a programme position by mistake, you need to reset that channel manually.

Changing/disabling programme positions (continued)

Changing the station names

You can change or enter the station names (up to 4 characters).

Before you start...

- Turn on the VCR and the TV.
- Set the TV to the video channel.
- Refer to “Index to parts and controls” for button locations.

1

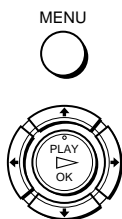

Press MENU, then press **↑/↓/←/→** to highlight **INSTALLATION** and press OK.

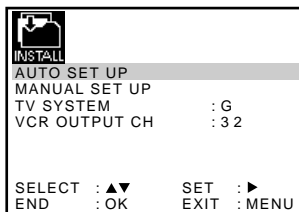

2



Press **↑/↓** to highlight **MANUAL SET UP**, then press **→**.

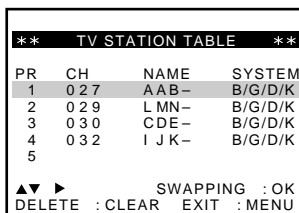

3



Press **↑/↓** to highlight the row which you want to change or enter the station name, then press **→**.

To display other pages for programme positions 6 to 80, press **↑/↓** repeatedly.

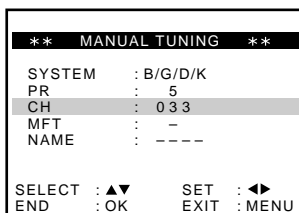

4



Press **↑/↓** to highlight **NAME**, then press **→**.

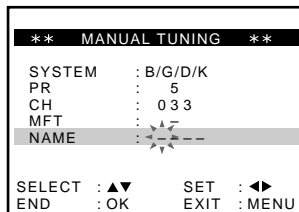

5



Enter the station name.

1 Press **↑/↓** to select a character.

Each time you press **↑**, the character changes as shown below.

A → **B** → ... → **Z** → **0** → **1**
→ ... → **9** → **A**

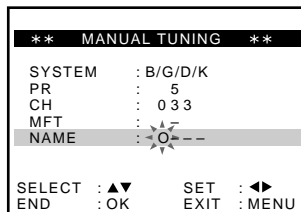

2 Press **→** to set the next character.

The next space flashes.

To correct a character, press **←/→** until the character you want to correct flashes, then reset it.

You can set up to 4 characters for the station name.

6



Press **OK** to confirm the new name.

7

MENU



Press **MENU** to exit the menu.

Playing a tape

Before you start...

- Refer to “Index to parts and controls” for button locations.

1 Turn on your TV and set it to the video channel.

2 Insert a tape.
The VCR turns on and starts playing automatically if you insert a tape with its safety tab removed.

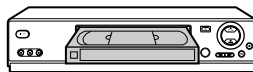

3 Press  PLAY.
When the tape reaches the end, it will rewind automatically.



Additional tasks

To	Press
Stop play	■ STOP
Pause play	▬ PAUSE
Resume play after pause	▬ PAUSE or ▷ PLAY
Fast-forward the tape	▶▶ FF during stop
Rewind the tape	◀◀ REW during stop
Eject the tape	▲ EJECT

To set the colour system

If the playback picture has no colour, or streaks appear during playback, set COLOUR SYSTEM in the USER SET menu to conform to the system that the tape was recorded in (see page 58). (Normally set the option to AUTO.)

To use the time counter

Press CLEAR at the point on the tape that you want to find later. The counter in the display window resets to “0:00:00.” Search for the point afterwards by referring to the counter.

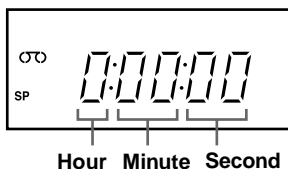

To display the counter on the TV screen, press DISPLAY.

Notes

- The counter resets to “0:00:00” whenever a tape is reinserted.
- The counter stops counting when it comes to a portion with no recording.
- If a tape has portions recorded in both PAL and NTSC systems, the time counter reading will not be correct. This discrepancy is due to the difference between the counting cycles of the two colour systems.
- Depending on your TV, the following may occur while playing an NTSC-recorded tape:
 - The picture becomes black and white.
 - The picture shakes.
 - No picture appears on the TV screen.
 - Black streaks appear horizontally on the TV screen.
 - The colour density increases or decreases.
- Tapes recorded in the LP mode of other NTSC system VCRs can be played back on this VCR, but the picture quality cannot be guaranteed.
- While setting the menu on the TV screen, buttons for playback on the remote commander do not function.

Recording TV programmes

Before you start...

- Refer to “Index to parts and controls” for button locations.

1

Turn on your TV and set it to the video channel.

2

Insert a tape with its safety tab in place.

3

• PROG



INPUT
SELECT



- To record a normal channel, press PROG +/- until the programme position number you want appears in the display window.

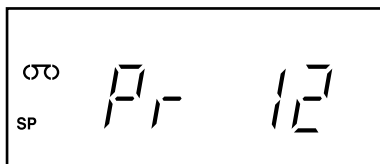

- To record from other equipment connected to one or more of the LINE inputs, press INPUT SELECT to display the connected line in the display window.

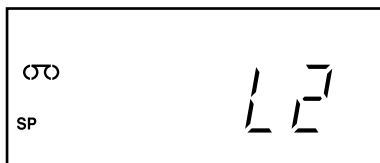

4

REC SPEED



Press REC SPEED to select the tape speed (SP or LP for the PAL colour system, and SP or EP for the NTSC colour system).

LP (Long Play) provides recording time twice as long as SP (Standard Play). EP (Extended Play) provides recording time three times as long as SP. However, SP produces better picture and audio quality.

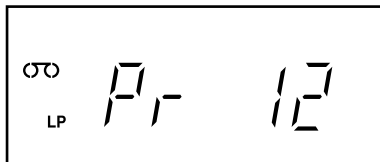

5



Press ● REC to start recording.

The recording indicator lights up red in the display window.

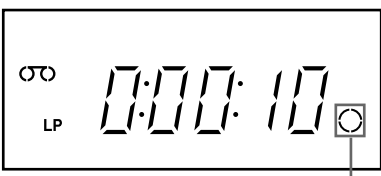

Recording indicator

To stop recording

Press ■ STOP.

To check the remaining time

Press DISPLAY. Each time you press DISPLAY, the display changes as shown below.

Sound system, TV system, colour system, programme position, tape speed and time counter → Remaining time → Current date and time, and time counter

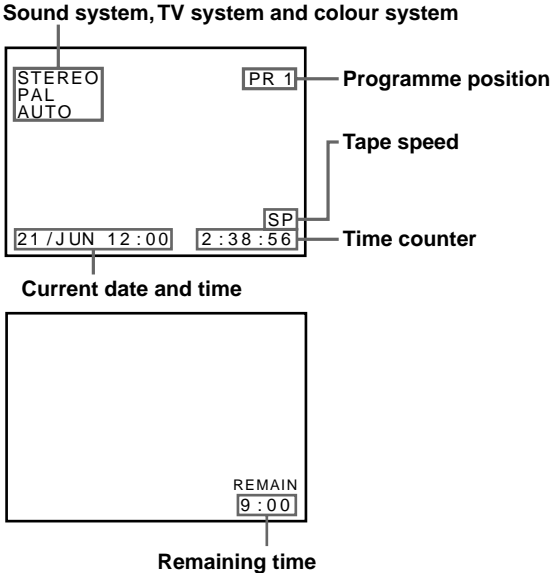

In order to get an accurate remaining time indication, be sure TAPE SELECT in the USER SET menu is set according to the tape type you use (see page 58).

continued

Recording TV programmes (continued)

To watch another TV programme while recording

1 If the TV is connected to the VCR using an audio/video cable, set the TV to TV input. If the TV is connected to the VCR using only the aerial cable, skip this step.

2 Select another programme position on the TV.

To save a recording

To prevent accidental erasure, break off the safety tab as illustrated. To record on the same tape again, cover the tab hole with adhesive tape.

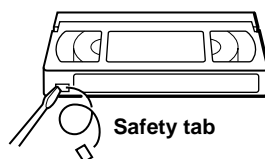

To record NTSC colour system programmes*¹

NTSC colour signals can be recorded on this VCR from the LINE IN 1 and LINE-2 IN jacks only.

To select the line input, press INPUT SELECT to display the connected line in the display window.

For tape speed, select SP or EP in step 4.

EP (Extended Play) provides recording time three times as long as SP. However, SP produces better picture and sound quality.

When playing a tape, the VCR automatically detects the tape speed.

Tips

- To select a programme position, you can use the programme number buttons on the remote commander. For two-digit numbers, for example, press 2 and 3 to select "Pr 23."
- If you connect additional equipment to the LINE IN 1 or LINE-2 IN*² jacks, you can select the input signal using the INPUT SELECT or PROG +/- buttons.
- The DISPLAY information appears on the TV screen indicating information about the tape, but the information will not be recorded on the tape.
- If you do not want to watch TV while recording, you can turn off the TV.

Notes

- The DISPLAY information does not appear during still (pause) mode or slow-motion playback.
- If a tape has portions recorded in both PAL and NTSC systems, the time counter reading will not be correct. This discrepancy is due to the difference between the counting cycles of the two video systems.
- When you insert a non-standard commercially available tape, the remaining time may not be correct.
- The remaining time is intended for rough measurement only.
- About 30 seconds after the tape begins playback, the tape remaining time will be displayed.

*1 SLV-EZ727AZ only

*2 SLV-EZ727AZ and EZ725AZ only

Recording TV programmes using the Easy Timer

The Easy Timer function allows you to make timer recordings of programmes without turning on your TV. Set the recording timer to record up to eight programmes, including settings made with other timer methods, that will be broadcast within the next month. The recording start time and recording stop time can be set at one minute intervals.

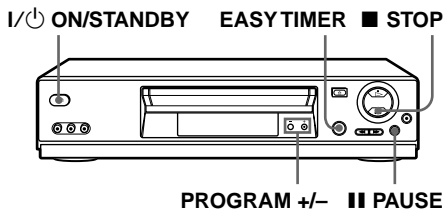

Before you start...

- Insert a tape with its safety tab in place. Make sure the tape is longer than the total recording time.
- Refer to “Index to parts and controls” for button locations.

1

EASY TIMER



Press EASY TIMER.

“DATE” and “TODAY” appear alternately in the display window.

If the date and time are not set, “DAY” will appear. See step 2 in the following section, “To set the clock” to set the date and time.

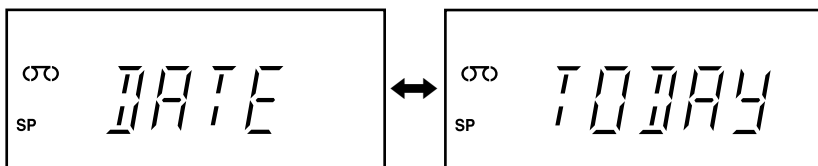

2

EASY TIMER

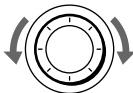

Turn EASY TIMER to set the recording date.

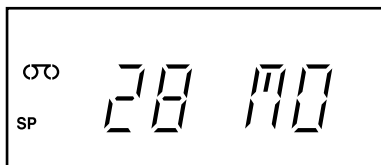

3

EASY TIMER

Press EASY TIMER.



START indicator and the current time appear in the display window.

**4**

EASY TIMER

Turn EASY TIMER to set the recording start time.

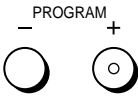

You can set the recording start time in 15 minute intervals or adjust the time in one minute intervals by pressing the PROGRAM +/- buttons.

**5**

EASY TIMER

Press EASY TIMER.

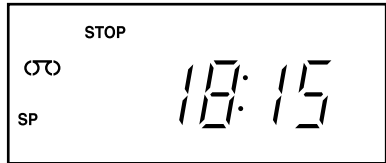

STOP indicator and the recording stop time appear in the display window.

**6**

EASY TIMER

Turn EASY TIMER to set the recording stop time.

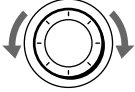

You can set the recording stop time in 15 minute intervals or adjust the time in one minute intervals by pressing the PROGRAM +/- buttons.

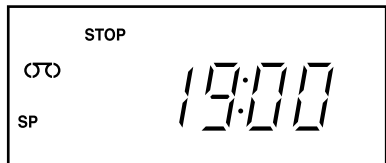
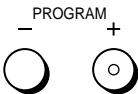
*continued*

Recording TV programmes using the Easy Timer (continued)

7

EASY TIMER



Press EASY TIMER.

The programme position or LINE input appears in the display window.



8

EASY TIMER



INPUT
SELECT



Turn EASY TIMER to set the programme position.

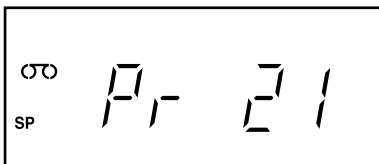

To record from other equipment connected to one or more of the LINE inputs, turn EASY TIMER or press INPUT SELECT to display the connected line in the display window.

9

EASY TIMER



Press EASY TIMER.

The current tape speed mode appears in the display window.



10

EASY TIMER

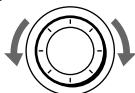

Turn EASY TIMER to set the tape speed, SP, LP or AUTO.



11

EASY TIMER



Press EASY TIMER to complete the setting.

“OK” appears in the display window for about five seconds.

The ⊖ indicator appears in the display window and the VCR stands by for recording.

To record from other equipment, leave the connected equipment switched on.

To return to the previous step

To return to the previous step, press the PROGRAM + and – buttons on the VCR at the same time during any of the Easy Timer settings.

To stop recording

To stop the VCR while recording, press ■ STOP.

To use the VCR after setting the timer

To use the VCR before a recording begins, just press I/⏻. The ⊖ indicator turns off and the VCR switches on. Remember to press I/⏻ to reset the VCR to recording standby after using the VCR.

You can also do the following tasks while the VCR is recording:

- Reset the counter (page 31).
- Display tape information on the TV screen (page 33).
- Check the timer settings (page 50).
- Watch another TV programme (page 34).

To use the Auto Tape Speed function

In step 10 above, turn EASY TIMER to select AUTO. When you are recording a programme in the SP mode and the remaining tape length becomes shorter than the recording time, the recording tape speed is automatically changed to the LP mode (or EP mode when you are recording NTSC signals*¹). Note that some noise will appear on the picture when the tape speed is changed. To operate this function correctly, the “TAPE SELECT” setting in the USER SET menu must be accurate (see page 58).

continued

Recording TV programmes using the Easy Timer (continued)

To set the clock

- 1** Hold down EASY TIMER so that “DAY” appears in the display window. However, if the clock has already been set, the current setting appears.
- 2** Turn EASY TIMER to set the day.
- 3** Press EASY TIMER.
MONTH indicator and “1” appear in the display window.
- 4** Turn and press EASY TIMER to set the month, and then the year. After you set the year, “CLOCK” appears in the display window.
- 5** Turn and press EASY TIMER to set the hour and minute.
- 6** When you have finished setting the time, press EASY TIMER to start the clock.

Tips

- To cancel a Easy Timer setting, press ■ **STOP on the VCR** while you are making the setting.
- To check, change, or cancel the programme setting, see “Checking/changing/cancelling timer settings” on page 50.
- To record NTSC signals*¹ in EP mode, set the tape speed to LP. Even when timer recording is set to LP mode, NTSC signals are automatically recorded in EP mode.

Notes

- If eight programmes have already been set using the G-CODE system*² or the TIMER PROGRAMMING menu, “FULL” appears in the display window for about five seconds.
- The ⊖ indicator flashes in the display window when you complete the setting in step 11 with no tape inserted.
- When the time is set incorrectly, “ERROR” appears in the display window in step 11. Set the timer again from step 1.

About the Demonstration Mode

The Easy Timer function has a Demonstration Mode that allows the user, such as a salesperson, to enter more than eight examples of timer settings when demonstrating the use of the Easy Timer. It cancels the “FULL” notice which appears if eight programmes have already been set. Do not use the Demonstration Mode for making timer recordings. Doing so may cause the settings to be inaccurate.

To activate the Demonstration Mode

Press **||** PAUSE on the VCR while turning the EASY TIMER. “DEMO” appears in the display window for a few seconds.

To cancel the Demonstration Mode

Turn the power off and unplug the mains lead. Although the Demonstration Mode is cancelled, the timer settings entered while using the Demonstration Mode will remain. Be sure to manually cancel the timer settings before you use the Easy Timer or any other timer method after reconnecting the mains lead (see page 50).

*1 SLV-EZ727AZ only

*2 SLV-EZ727AZ and EZ424AZ only

Recording TV programmes using the G-CODE® system (SLV-EZ727AZ and EZ424AZ only)

The G-CODE system is the feature that simplifies programming the VCR to make timer recordings. Just enter the G-code number listed in the TV programme guide. The date, times, and programme position of that programme are set automatically. You can preset a total of eight programmes, including settings made with other timer methods.

Before you start...

- Check that the VCR clock is set to the correct time and date.
- Insert a tape with its safety tab in place. Make sure the tape is longer than the total recording time.
- Turn on your TV and set it to the video channel.
- Refer to “Index to parts and controls” for button locations.

1



Press the G-CODE button.

The G-CODE menu appears on the TV screen.

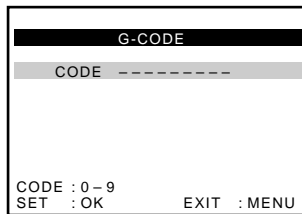

2

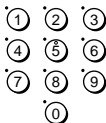

Press the programme number buttons to enter the G-code number.

If you make a mistake, press CLEAR and re-enter the correct number.

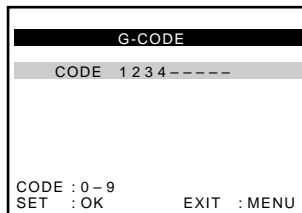

3



Press OK.
The date, start and stop times and tape speed appear on the TV screen.

PR	DAY	START	-STOP
3 5	SA 2 9	1 9 : 0 0	- 2 0 : 0 0 SP
--	--	--	--
--	--	--	--
--	--	--	--

SELECT : ▲▼ SET : ◀▶
END : OK EXIT : MENU



- If “--” appears in the “PR” (programme) column (this may happen for local broadcasts), you have to set the appropriate programme position manually. Press ▲/▼ to select the desired programme position.
- To record from other equipment connected to one or more of the LINE inputs, press INPUT SELECT to display the connected line in the “PR” position.

You will only have to do this operation once for the referred channel. The VCR will then store your setting.

If the information is incorrect, press CLEAR to cancel the setting.

4



If you want to change the date and tape speed:

- 1 Press ◀/▶, to select the item you want to change.
- 2 Press ▲/▼ to reset it.

PR	DAY	START	-STOP
3 5	SA 2 9	1 9 : 0 0	- 2 0 : 0 0 SP
--	--	--	--
--	--	--	--
--	--	--	--

SELECT : ◀▶ SET : ▲▼
END : OK EXIT : MENU

To record the same programme every day or the same day every week, see “Daily/weekly recording” on page 44.

5



Press MENU to exit the menu.

6



Press I/⏻ to turn off the VCR.

The ⊖ indicator appears in the display window and the VCR stands by for recording.

To record from other equipment, leave the connected equipment switched on.

To stop recording

To stop the VCR while recording, press ■ STOP.

continued

Recording TV programmes using the G-CODE® system (SLV-EZ727AZ and EZ424AZ only) (continued)

Daily/weekly recording

In step 4 above, press **↓** to select the recording pattern. Each time you press **↓**, the indication changes as shown below. Press **↑** to change the indication in reverse order.

today → **DLY (Monday to Sunday)** → **W-SA (every Saturday)**
→ **W-SU (every Sunday)** → **1 month later** → **(dates count down)**
→ **today**

To use the VCR after setting the timer

To use the VCR before a recording begins, just press **I/⏻**. The **⊖** indicator turns off and the VCR switches on. Remember to press **I/⏻** to reset the VCR to recording standby after using the VCR.

You can also do the following tasks while the VCR is recording:

- Reset the counter (page 31).
- Display tape information on the TV screen (page 33).
- Check the timer settings (page 50).
- Watch another TV programme (page 34).

To use the Auto Tape Speed function

In step 4 above, press **↓** to select AUTO. When you are recording a programme in the SP mode and the remaining tape length becomes shorter than the recording time, the recording tape speed is automatically changed to the LP mode (or EP mode when you are recording NTSC signals*). Note that some noise will appear on the picture when the tape speed is changed. To operate this function correctly, the “TAPE SELECT” setting in the USER SET menu must be accurate (see page 58).

Tips

- To set the line input video source, you can also use the INPUT SELECT button.
- You can set the extended time for the G-CODE setting by 10, 20, 30, 40, 50, or 60 minutes. Set G-CODE EXTEND in the EASY OPERATION menu to the desired extended time on page 59.
- To check, change, or cancel the programme setting, see “Checking/changing/cancelling timer settings” on page 50.
- To record NTSC signals* in EP mode, set the tape speed to LP. Even when timer recording is set to LP mode, NTSC signals are automatically recorded in EP mode.

Note

- The **⊖** and **⊙** indicators flash in the display window when you press **I/⏻** with no tape inserted.

* SLV-EZ727AZ only

Recording TV programmes using the timer

You can preset a total of eight programmes, including settings made with other timer methods.

Before you start...

- Check that the VCR clock is set to the correct time and date.
- Insert a tape with its safety tab in place. Make sure the tape is longer than the total recording time.
- Turn on your TV and set it to the video channel.
- Refer to “Index to parts and controls” for button locations.

1 Press MENU, then press **↑/↓/←/→** to highlight **TIMER PROGRAMMING** and press **OK**.

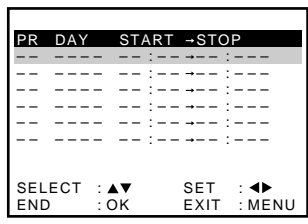
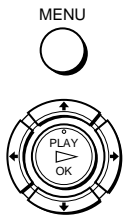

2 Set the date, start and stop times and tape speed:

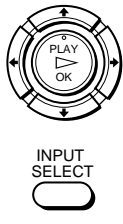

- 1 Press **→** to select each item in turn.
 - 2 Press **↑/↓** to set each item.
- To correct a setting, press **←** to return to that setting and reset.

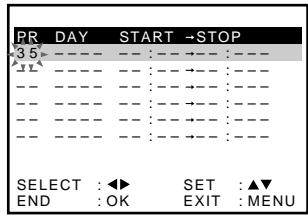

- To record the same programme every day or the same day every week, see “Daily/weekly recording” on page 46.
- To record from other equipment connected to one or more of the LINE inputs, press **INPUT SELECT** to display the connected line in the “PR” position.

3 Press **MENU** to exit the menu.



continued

4



Press I/⏻ to turn off the VCR.

The ⊖ indicator appears in the display window and the VCR stands by for recording.

To record from other equipment, leave the connected equipment switched on.

To stop recording

To stop the VCR while recording, press ■ STOP.

Daily/weekly recording

In step 2 above, press ↓ to select the recording pattern. Each time you press ↓, the indication changes as shown below. Press ↑ to change the indication in reverse order.

today → **DLY (Monday to Sunday)** → **W-SA (every Saturday)**
→ **W-SU (every Sunday)** → **1 month later** → **(dates count down)**
→ **today**

To use the VCR after setting the timer

To use the VCR before a recording begins, just press I/⏻. The ⊖ indicator turns off and the VCR switches on. Remember to press I/⏻ to reset the VCR to recording standby after using the VCR.

You can also do the following tasks while the VCR is recording:

- Reset the counter (page 31).
- Display tape information on the TV screen (page 33).
- Check the timer settings (page 50).
- Watch another TV programme (page 34).

To use the Auto Tape Speed function

In step 2 above, press ↓ to select AUTO. When you are recording a programme in the SP mode and the remaining tape length becomes shorter than the recording time, the recording tape speed is automatically changed to the LP mode (or EP mode when you are recording NTSC signals*). Note that some noise will appear on the picture when the tape speed is changed. To operate this function correctly, the “TAPE SELECT” setting in the USER SET menu must be accurate (see page 58).

Tips

- To set the line input video source, you can also use the INPUT SELECT button.
- To check, change, or cancel the programme setting, see “Checking/changing/cancelling timer settings” on page 50.
- To record NTSC signals* in EP mode, set the tape speed to LP. Even when timer recording is set to LP mode, NTSC signals are automatically recorded in EP mode.

Note

- The ⊖ and ○ indicators flash in the display window when you press I/⏻ with no tape inserted.

* SLV-EZ727AZ only

Playing/searching at various speeds

Before you start...

- Refer to “Index to parts and controls” for button locations.

Playback options	Operation
View the picture during fast-forward or rewind	During fast-forward, hold down ►► FF. During rewind, hold down ◀◀ REW.
Play at high speed	<ul style="list-style-type: none">• During playback, press ►► FF or ◀◀ REW <u>on the remote commander</u>.• During playback, hold down ►► FF or ◀◀ REW. When you release the button, normal playback resumes.
Play at twice the normal speed	During playback, press ×2.
Play in slow motion	During playback, press ►► SLOW.
Play frame by frame	During pause, press ►► FF <u>on the remote commander</u> .

To resume normal playback

Press ▷ PLAY.

Setting the recording duration time

After you have started recording in the normal way, you can have the VCR stop recording automatically after a specified duration.

Before you start...

- Refer to “Index to parts and controls” for button locations.

1 While recording, press ● REC.

The ⊖ indicator appears in the display window.

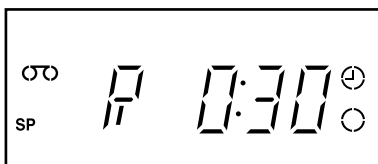

2 Press ● REC repeatedly to set the duration time.

In SP mode

Each press advances the time in increments of 30 minutes.

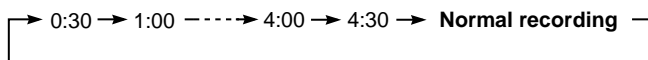

In LP (EP) mode

Each press advances the time as shown below.

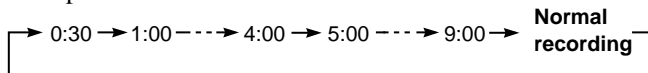

The tape counter decreases minute by minute to 0:00, then the VCR stops recording and turns off automatically.

To extend the duration

Press ● REC repeatedly to set a new duration time.

To cancel the duration

Press ● REC repeatedly until the ⊖ indicator disappears and the VCR returns to the normal recording mode.

To stop recording

To stop the VCR while recording, press ■ STOP.

Note

- You cannot display the current tape time in the display window when setting the recording duration time.

Checking/changing/cancelling timer settings

Before you start...

- Turn on your TV and set it to the video channel.
- Refer to “Index to parts and controls” for button locations.

- 1 Press I/⏻ to turn on the VCR.
- 2 Press MENU, then press ↑/↓/←/→ to highlight **TIMER PROGRAMMING** and press OK.

- If you want to change or cancel a setting, go on to the next step.
- If you do not need to change or cancel the settings, press MENU, then turn off the VCR to return to recording standby.

PR	DAY	START	-STOP	
35	SA 29	19 : 00	+20 : 00	SP
29	SA 29	21 : 00	+21 : 30	-
30	SA 6	12 : 00	+13 : 30	-
-	-	-	-	-
-	-	-	-	-
-	-	-	-	-
-	-	-	-	-

SELECT : ▲▼ SET : ◀▶
END : OK EXIT : MENU

- 3 Press ↑/↓ to select the setting you want to change or cancel, then press →. The PR number on the selected row flashes.

PR	DAY	START	-STOP	
35	SA 29	19 : 00	+20 : 00	SP
29	SA 29	21 : 00	+21 : 30	-
30	SA 6	12 : 00	+13 : 30	-
-	-	-	-	-
-	-	-	-	-
-	-	-	-	-
-	-	-	-	-

SELECT : ▲▼ SET : ◀▶
END : OK EXIT : MENU

- 4
 - To change the setting, press ←/→ to select the item you want to change, then press ↑/↓ to reset it.
 - To cancel the setting, press CLEAR.

- 5 Press MENU to exit the menu.

If any settings remain, turn off the VCR to return to recording standby.

When the timer settings overlap

The programme that starts first has priority and the second programme starts recording only after the first programme has finished. If the programmes start at the same time, the programme listed first in the menu has priority.

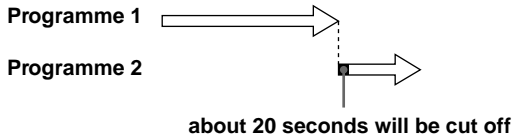
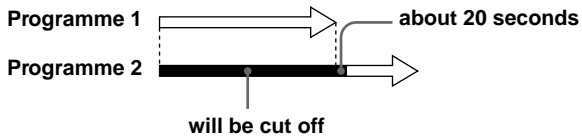

Recording stereo and bilingual programmes (SLV-EZ727AZ and EZ725AZ only)

In the ZWEITON (German stereo) system

This VCR automatically receives and records stereo and bilingual programmes based on the ZWEITON system. When a stereo or bilingual programme is received, the STEREO indicator appears in the display window.

To select bilingual sound while recording

Press AUDIO MONITOR to select the sound you want.

To listen to	On-screen display	Display window
Main	MAIN	STEREO
Sub	SUB	STEREO
Main and sub	MAIN/SUB	STEREO
Standard sound*	MONO	STEREO

* Usually the main channel heard from both the left and right in bilingual programmes

To select stereo programme while recording

To listen to	On-screen display	Display window
Stereo	STEREO	STEREO
Left channel	LCH	STEREO
Right channel	RCH	STEREO
Standard sound	LCH + RCH	STEREO

* Usually the mixed sound of left and right channels in stereo programmes

In the NICAM system

This VCR receives and records stereo and bilingual programmes based on the NICAM system (NICAM appears on the TV screen). When a stereo or bilingual programme is received, the STEREO indicator appears in the display window.

To record a NICAM programme, NICAM in the USER SET menu should be set to ON (initial setting). To check the menu setting, see page 59 for details.

To select the sound while recording

Press AUDIO MONITOR to select the sound you want.

Stereo programmes

To listen to	On-screen display	Display window
Stereo	NICAM, STEREO	NICAM, STEREO
Left channel	NICAM, LCH	NICAM, STEREO
Right channel	NICAM, RCH	NICAM, STEREO
Left and right channels*	NICAM, LCH + RCH	NICAM, STEREO

* Usually the mixed sound of left and right channels

Bilingual programmes

To listen to	On-screen display	Display window
Main	NICAM, MAIN	NICAM, STEREO
Sub	NICAM, SUB	NICAM, STEREO
Main and sub	NICAM, MAIN/SUB	NICAM, STEREO
Standard sound*	NICAM, MONO	NICAM, STEREO

* Usually the main sound (monaural)

continued

Recording stereo and bilingual programmes (SLV-EZ727AZ and EZ725AZ only) (continued)

Selecting the sound during Hi-fi playback

Press AUDIO MONITOR to select the sound you want.

To listen to	On-screen display	Display window
Stereo	STEREO	STEREO
Left channel	LCH	STEREO
Right channel	RCH	STEREO
Mix sound*	MIX	STEREO
Mono sound	MONO	No indicator

* The mixed sound of left and right channels, and the normal mono audio track

How sound is recorded on a video tape

The VCR records sound onto two separate tracks. Hi-fi audio is recorded onto the main track along with the picture. Monaural sound is recorded onto the normal audio track along the edge of the tape.

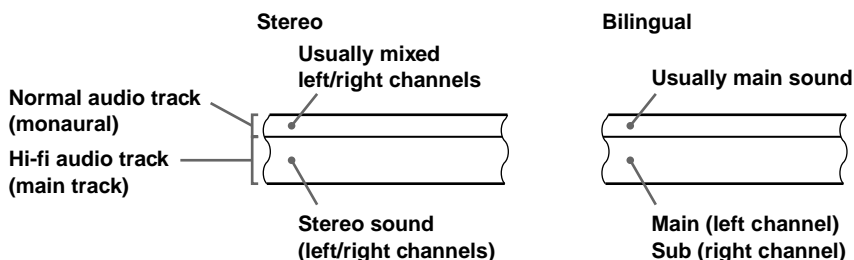

Notes

- To listen to playback sounds in stereo, you must use the AUDIO OUT connections.
- When you play a tape recorded in monaural, the sound is heard in monaural regardless of the AUDIO MONITOR setting.

Searching using the index function

The VCR automatically marks the tape with an index signal at the point where each recording begins. Use these signals as references to find a specific recording.

To find a specific recording by scanning (Index scan)

- 1** Insert an indexed tape into the VCR.
- 2** Press **◀◀/▶▶** INDEX SEARCH. The VCR starts scanning each recording for five seconds in the corresponding direction.



INDEX SCAN : ▶▶

- 3** Press **▷** PLAY to start playback when you find the desired point.

To search a specific recording (Index search)

- 1** Insert an indexed tape into the VCR.
- 2** Press **◀◀/▶▶** INDEX SEARCH twice.
 - To search ahead, press **▶▶** INDEX SEARCH twice.
 - To search backwards, press **◀◀** INDEX SEARCH twice.



INDEX SEARCH : ▶▶ +02

- 3** Press **◀◀/▶▶** INDEX SEARCH depending on the direction where your desired programme is located. Each time you press the button, the number increases or decreases up to ± 20 , respectively.
- 4** The VCR starts searching, and playback starts automatically from that point.

To stop searching

Press **■** STOP.

Notes

- No index signal will be added when recording starts from recording pause. However, an index signal will be marked if you change the programme position during recording pause.
- When you press **◀◀** INDEX SEARCH, if there is nothing recorded before the selected index signal, playback may not start exactly at the index signal.

Adjusting the picture

Adjusting the tracking

Although the VCR automatically adjusts the tracking when playing a tape, distortion may occur if the recording is in poor condition. In this case, manually adjust the tracking.

During playback, press TRACKING +/- on the VCR to display the tracking meter. The distortion should disappear as you press one of the two buttons. To resume automatic tracking adjustments, eject the tape and reinsert it.

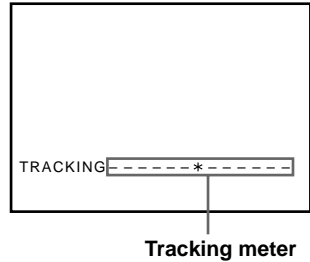

Adjusting the picture sharpness (Auto Sharpness Control)

You can automatically adjust the sharpness of the picture.

1 During playback, press MENU, then press **↑/↓/←/→** to highlight USER SET and press OK.

2 Press **↑/↓** to highlight ASC, then press **→**.

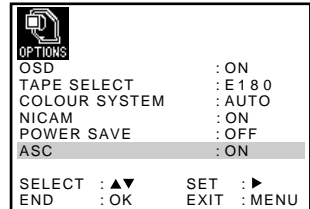

3 Press **↑/↓** to set ASC to ON or OFF.

- ON: Picture sharpness is automatically adjusted.
- OFF: Adjust the picture sharpness manually.
To soften the picture, press **←**.
To sharpen the picture, press **→**.

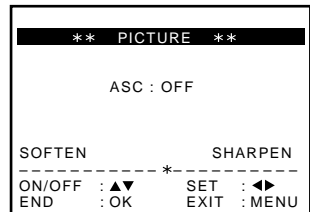

4 Press MENU to return to the original screen.

Reducing the VCR's power consumption

You can turn off the indicators in the display window when the VCR is off (standby mode) to reduce the VCR's power consumption.

- 1** Press MENU, then press **↑/↓/←/→** to highlight USER SET and press OK.
- 2** Press **↑/↓** to highlight POWER SAVE.
- 3** Press **→** to set to ON, then press OK.
The power consumption is reduced to a minimum.

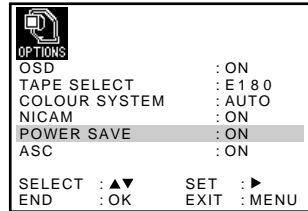

To turn on the indicators in the display window

Set POWER SAVE to OFF in step 3.

Note

- When the VCR stands by for recording, the \ominus indicator in the display window remain lit even when POWER SAVE is set to ON.

Changing menu options

- 1 Press MENU, then select USER SET or EASY OPERATION and press OK.

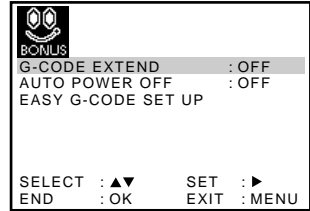
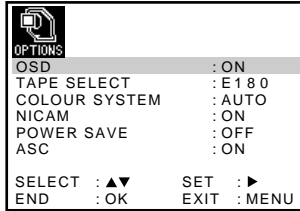

- 2 Press **↑/↓** to select the option.
- 3 Press **→** to change the setting, then press OK.

Menu choices

Initial settings are indicated in bold print.

USER SET

Menu option	Set this option to
OSD	<ul style="list-style-type: none"> • ON to display the menu on the TV screen. • OFF to disappear the menu from the TV screen.
TAPE SELECT	<ul style="list-style-type: none"> • E180 to use an E-180 or shorter type tape. • E240 to use an E-240 type tape. • E260 to use an E-260 type tape. • E300 to use an E-300 type tape.
COLOUR SYSTEM	<ul style="list-style-type: none"> • AUTO to select the colour system automatically. • PAL to use the tape recorded in the PAL colour system. • B/W to use the tape recorded in black and white. <p>When using the tape recorded NTSC colour signals:</p> <ul style="list-style-type: none"> • NT3.58*1 to use the tape recorded in the NTSC 3.58 colour system. • NT4.43 to use the tape recorded in the NTSC 4.43 colour system. • NTPB to play back an NTSC-recorded tape on PAL TV.

Menu option	Set this option to
NICAM* ²	<ul style="list-style-type: none"> • ON to record NICAM broadcasts on the hi-fi audio track. • OFF to record standard sound on the hi-fi audio track. <p>For details, see page 53.</p>
POWER SAVE	<ul style="list-style-type: none"> • ON to turn off the indicators in the display window to conserve the VCR's power. • OFF to turn on the indicators in the display window while the VCR is standing by.
ASC	<ul style="list-style-type: none"> • ON to automatically adjust the sharpness of the picture. • OFF to manually adjust the sharpness of the picture.

EASY OPERATION

Menu option	Set this option to
G-CODE EXTEND* ³	<ul style="list-style-type: none"> • OFF to deactivate the G-CODE Extend function. • 10/20/30/.../60 (minutes) to extend the time of the G-CODE setting by the selected amount of time.
AUTO POWER OFF	<ul style="list-style-type: none"> • OFF to deactivate the Auto Power Off function. • 2HOUR/3HOUR to turn the VCR off automatically if no signal is received and you do not press any of the buttons during this time.
EASY G-CODE SET UP* ³	• —

*¹ SLV-EZ727AZ only

*² SLV-EZ727AZ and EZ725AZ only

*³ SLV-EZ727AZ and EZ424AZ only

Connecting to a VCR or stereo system

How to connect to record on this VCR

Connect the line outputs of the other VCR to the input connector of this VCR. Refer to the examples A through C and choose the connection that best suits your VCR.

Example A (SLV-EZ424AZ and EZ121AZ only)

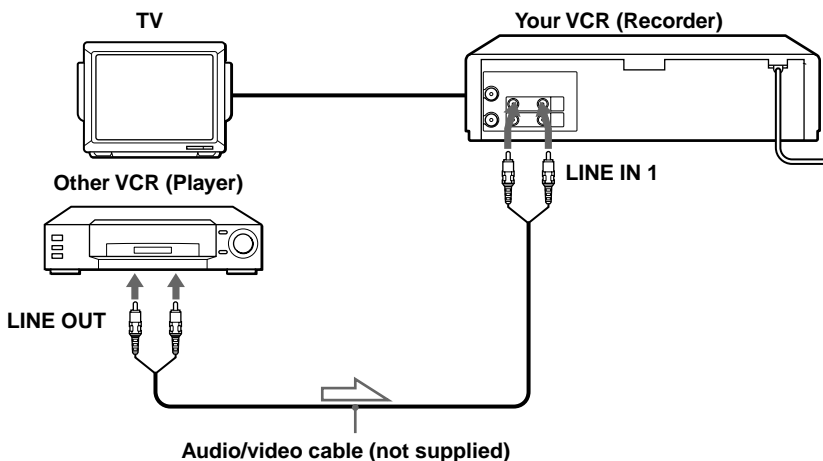

 : Signal flow

Example B (SLV-EZ727AZ and EZ725AZ only)

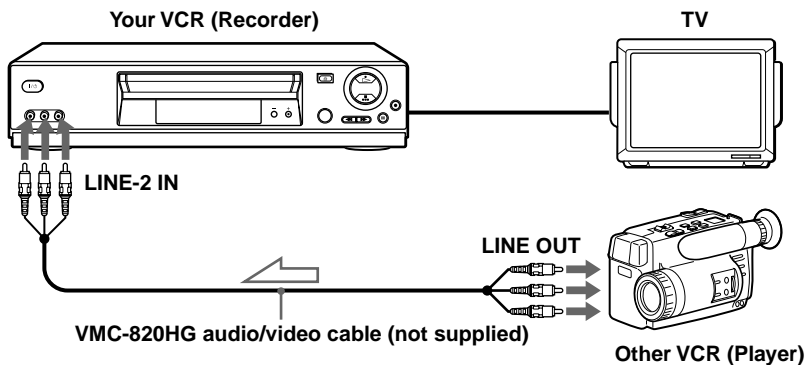

 : Signal flow

Example C (SLV-EZ727AZ and EZ725AZ only)

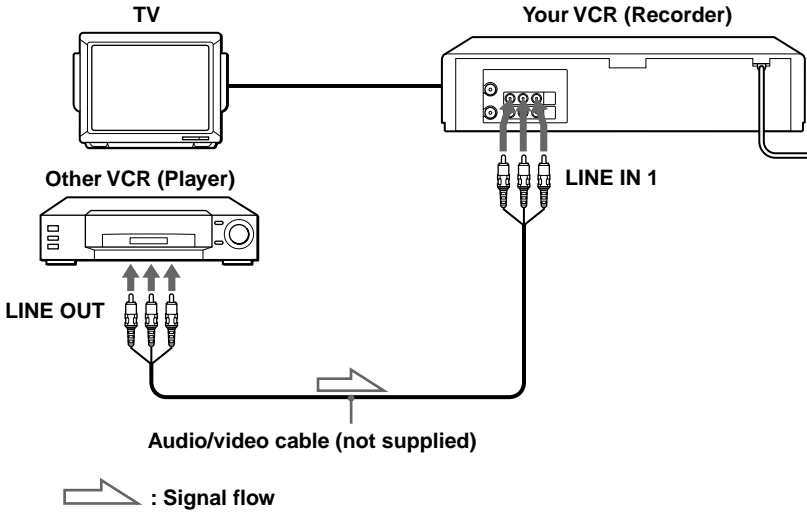

How to connect to a stereo system (SLV-EZ727AZ and EZ725AZ only)

Connect the LINE-2 IN jacks on this VCR to the audio output jacks on the stereo system, using the RK-C510HG audio cable (not supplied).

Notes

- Make sure you connect the plugs to jacks of the same colour.
- If the other VCR is a monaural type, leave the red plugs unconnected.
- If you connect this VCR to both the LINE IN and LINE OUT jacks of the other VCR, select the input correctly to prevent a humming noise.
- When you connect another VCR to the LINE-2 IN connector, press INPUT SELECT to display "L2" in the display window.

Basic editing

When recording on this VCR

Before you start editing

- Turn on your TV and set it to the video channel.
- Press INPUT SELECT to display the connected line in the display window.
- Press REC SPEED to select the tape speed.

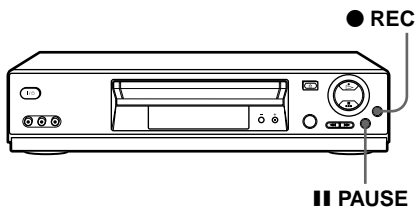

- 1** Insert a source tape with its safety tab removed into the other (playback) VCR. Search for the point to start playback and set it to playback pause.
- 2** Insert a tape with its safety tab in place into this (recording) VCR. Search for the point to start recording and press **|| PAUSE** to set it to playback pause.
- 3** Press **● REC** on this VCR to set it to recording pause.
- 4** To start editing, press the **|| PAUSE** buttons on both VCRs at the same time.

To stop editing

Press the **■ STOP** buttons on both VCRs.

Tip

- To cut out unwanted scenes while editing, press **|| PAUSE** on this VCR when an unwanted scene begins. When it ends, press **|| PAUSE** again to resume recording.

Troubleshooting

If you have any questions or problems not covered below, please consult your nearest Sony service facility.

	Symptom	Remedy
	The I/⏻ ON/STANDBY switch does not function.	<ul style="list-style-type: none"> • Connect the mains lead to the mains securely.
Power	The power is turned on but the VCR does not operate.	<ul style="list-style-type: none"> • Moisture condensation has occurred. Turn the power off, unplug the mains lead and leave the VCR to dry for over three hours.
	The VCR is plugged in but the display window remains dark.	<ul style="list-style-type: none"> • Set POWER SAVE in the USER SET menu to OFF (see page 57).
Clock	The clock has stopped and “- -: -” appears in the display window.	<ul style="list-style-type: none"> • The clock stops if the VCR is disconnected from the mains. Reset the clock (and timer).
	The playback picture does not appear on the TV screen.	<ul style="list-style-type: none"> • Make sure the TV is set to the video channel. If you are using a monitor, set it to video input. • If you made connections using the aerial cable only, make sure the RF channel number is set correctly for your area.
Playback	The picture is not clear.	<ul style="list-style-type: none"> • Existing broadcasts may interfere with the VCR. Reset the RF channel output of your VCR (see page 17). • Adjust the tracking with the TRACKING +/- buttons on the VCR. • The video heads are dirty (see the last page of Troubleshooting). Clean the video heads using the Sony T-25CLD, E-25CLDR, or T-25CLW video head cleaning cassette. If these cleaning cassettes are not available in your area, have the heads cleaned at your nearest Sony service facility (a standard service charge will be required). Do not use a commercially available liquid type cleaning cassette other than Sony's, as it may damage the video heads. • The video heads may have to be replaced. Consult your local Sony service facility for more information.
	The picture has no colour.	<ul style="list-style-type: none"> • The COLOUR SYSTEM option in the USER SET menu is set to the wrong position. Set the option to conform to the system that the tape was recorded in.
	The picture rolls vertically during picture search.	<ul style="list-style-type: none"> • Adjust the vertical hold control on the TV or monitor.

continued

Troubleshooting (continued)

	Symptom	Remedy
Playback	The picture has no sound.	<ul style="list-style-type: none"> • The tape is defective. • If you made A/V connections, check the audio cable connection. • If you made connections using the aerial cable only, make sure the TV system is set correctly for your area.
	The sound from a tape recorded with the VCR is not in stereo or the STEREO indicator in the display window is flashing.	<ul style="list-style-type: none"> • Adjust the tracking. • The video heads are dirty. Clean the video heads using the Sony T-25CLD, E-25CLDR, or T-25CLW video head cleaning cassette as explained above.
	No TV programme appears on the TV screen.	<ul style="list-style-type: none"> • Make sure the TV is set to the video channel. If you are using a monitor, set it to video input. • Existing broadcasts may interfere with the VCR. Reset the RF channel output of your VCR (see page 17). • Select the correct source with the INPUT SELECT button. Select a programme position when recording TV programmes; select a line input when recording from other equipment.
Recording	TV reception is poor.	<ul style="list-style-type: none"> • Make sure the aerial cable is connected securely. • Adjust the TV aerial. • Make sure the TV system is correctly set for your TV. • Make sure TV SYSTEM (B/G or B/B) in the INSTALLATION menu is set to the same system in your local area.
	The recorded picture has no colour or unusual colour.	<ul style="list-style-type: none"> • Set COLOUR SYSTEM in the USER SET menu according to your local colour system.
	The tape starts playing as soon as it is inserted.	<ul style="list-style-type: none"> • The safety tab has been removed. To record on this tape, cover the tab hole (see page 34).
	The tape is ejected when you press ● REC.	<ul style="list-style-type: none"> • The safety tab has been removed. To record on this tape, cover the tab hole (see page 34).
	Nothing happens when you press ● REC.	<ul style="list-style-type: none"> • Make sure the tape is not at its end.

	Symptom	Remedy
Timer recording	The timer does not operate.	<ul style="list-style-type: none"> • Check that the clock is set. • Make sure a tape has been inserted. • Check that the safety tab has not been removed. • Make sure the tape is not at its end. • Make sure a programme has been set for timer recording. • Make sure your timer settings are past the current time. • The clock stops if the VCR is disconnected from the mains. Reset the clock and timer. • Turn the power off and unplug the mains lead.
	A tape cannot be inserted.	<ul style="list-style-type: none"> • Check that a tape is not already in the tape compartment.
Others	The remote commander does not function.	<ul style="list-style-type: none"> • Make sure you are pointing the remote commander at the remote sensor on the VCR. • Replace all the batteries in the remote commander with new ones if they are weak. • Make sure the •TV/VIDEO remote control switch is set correctly.
	The selected input line connector number does not appear in the display window.	<ul style="list-style-type: none"> • Press INPUT SELECT to display the connected line.
	The tracking meter does not appear on the TV screen.	<ul style="list-style-type: none"> • The recording condition of the tape is very poor and tracking cannot be adjusted.
	The display window becomes dim.	<ul style="list-style-type: none"> • The display window automatically becomes dim when the VCR is in standby mode.
	The VCR needs to be cleaned.	<ul style="list-style-type: none"> • Clean the cabinet, panel and controls with a dry, soft cloth, or a soft cloth slightly moistened with a mild detergent solution. Do not use any type of solvent, such as alcohol or benzine.

continued

Troubleshooting (continued)

Symptoms caused by contaminated video heads

- Normal picture
- Rough picture
- Unclear picture
- No picture (or black & white screen appears)



initial
contamination



terminal

Specifications

System

Colour system

PAL, NTSC 3.58*, NTSC 4.43

TV system

B/G, B/B

Channel coverage

B/G: VHF E2 to E12/UHF E21 to E69/

CATV S01 to S05, S1 to S41

B/B: VHF R1 to R12/UHF R21 to R69

RF output signal

UHF channels: 21 to 69 (B/G)

28 to 69 (B/B)

Aerial out

75-ohm asymmetrical aerial socket

Tape speed

SP: PAL 23.39 mm/s (recording/
playback)

NTSC 33.35 mm/s (recording (Line
input only)*/playback)

LP: PAL 11.70 mm/s (recording/
playback)

NTSC 16.67 mm/s (playback only)

EP: NTSC 11.12 mm/s (recording (Line
input only)*playback)

Maximum recording/playback time

10 hrs. in LP mode (with E300 tape)

Rewind time

Approx. 1 min. (with E180 tape)

* SLV-EZ727AZ only

Inputs and outputs

LINE IN 1/LINE-2 IN

VIDEO IN, phono jack (1)

Input signal: 1 Vp-p, 75 ohms,
unbalanced, sync negative

AUDIO IN, phono jack (2)

Input level: 327 mVrms

Input impedance: more than 47 kilohms

General

Power requirements

220 – 240 V AC, 50 Hz

Power consumption

15 W (SLV-EZ424AZ and EZ121AZ)

17 W (SLV-EZ727AZ and EZ725AZ)

3 W (POWER SAVE is set to ON,
minimum)

Operating temperature

5°C to 40°C

Storage temperature

-20°C to 60°C

Dimensions including projecting parts and controls (w/h/d)

Approx. 360 × 95 × 252 mm
(SLV-EZ424AZ and EZ121AZ)

Approx. 430 × 96 × 251 mm
(SLV-EZ727AZ and EZ725AZ)

Mass

Approx. 2.8 kg

(SLV-EZ424AZ and EZ121AZ)

Approx. 3.1 kg

(SLV-EZ727AZ and EZ725AZ)

Supplied accessories

Remote commander (1)

R6 (size AA) batteries (2)

Aerial cable (1)

Design and specifications are subject to
change without notice.

ENERGY STAR® is a U.S. registered mark.
As an ENERGY STAR® Partner, Sony
Corporation has determined that this product
meets the ENERGY STAR® guidelines for
energy efficiency.

Index

A

- Adjusting
 - picture 56
 - tracking 56
- Aerial hookup 14
- ASC (Auto Sharpness Control) 56
- Audio track 54
- Audio/video hookup 15
- Auto Set Up 16

C

- Changing the programme position 25
- Changing the station name 28
- Cleaning the video heads 63
- Clock setting 18
- Colour system
 - compatible colour systems 2
 - setting 30
- Connecting
 - the VCR and your TV 14
 - to a stereo system 15, 60
 - to a TV with audio/video jacks 15
- Counter 31

D

- Demonstration 41
- Disabling the programme positions 26
- Dubbing. *see* Editing

E

- Easy Timer 36
- Editing 60
- EP mode 32

H

- Hi-fi audio track 54

I

- Index scan 55
- Index search 55

L

- LP mode 32

M

- Manual fine tuning 24
- Monaural 53
- Monitoring
 - during playback 54
 - during recording 52

N

- NICAM broadcasts 53
- Normal audio track 54

O

- Optional setting 58

P

- Playback 30
 - at various speeds 48
 - frame-by-frame 48
 - selecting the sound 52
 - slow motion 48
- Power save 57
- Presetting channels 22

R

- Recording 32
 - bilingual programmes 52
 - duration time 49
 - saving 34
 - stereo programmes 52
 - timer setting 45
 - using the Easy Timer 36
 - using the G-CODE system 42
 - while watching another programme 34
- RF channel 16, 17

S

- Safety tab 34
- Searching
 - at various speeds 48
 - using the index function 55
- G-CODE
 - recording 42
 - setting 21, 43
- SP mode 32
- Stereo 52

T

- Timer setting 45
 - cancelling 50
 - changing 50
 - checking 50
 - daily/weekly recording 44, 46
 - using the Easy Timer 36
 - using the G-CODE system 42

Z

- ZWEITON broadcasts 52