

14SH644 (3 · 4 THREAD OVERLOCK MACHINE)

14SH654 (3 · 4 THREAD OVERLOCK MACHINE WITH DIFFERENTIAL FEED)

Operator's Guide

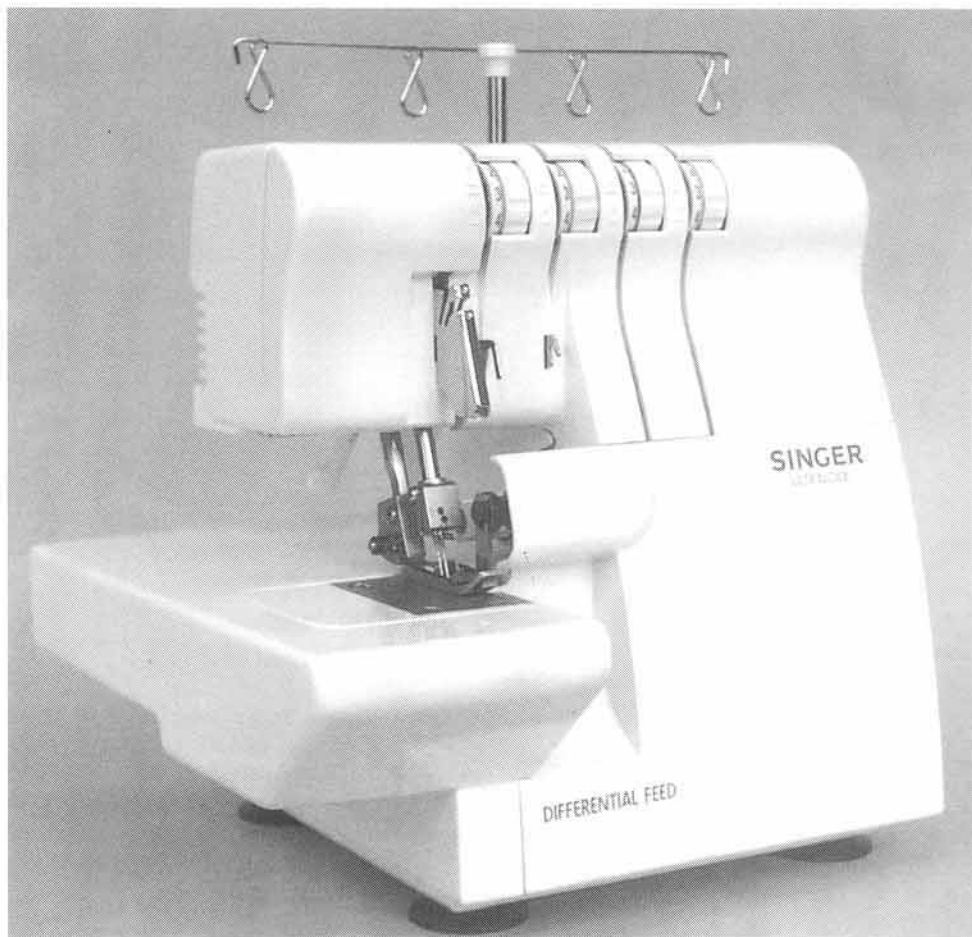

SINGER®

PREFACE

Thank you for your purchase of this sewing machine. This machine intended for household use will provide you with excellent performance in sewing from light to heavy material (lawn to denim). Please refer to this booklet for proper use and optimum service. To get the most out of your sewing machine, read the entire operator's guide before attempting to operate the machine. Then familiarize yourself with the machine by following the operator's guide page by page.

To ensure that you are always provided with the most modern sewing capabilities, the manufacturer reserves the right to change the appearance, design or accessories of this sewing machine when considered necessary without notification or obligation.

IMPORTANT SAFETY INSTRUCTIONS



- * If the supply cord is damaged, it must be replaced by the manufacturer or its service agent or a similarly qualified person in order to avoid a hazard.
- * The appliance is not intended for use by young children or infirm persons without supervision.
- * Young children should be supervised to ensure that they do not play with the appliance.
- * Switch off or unplug the machine when leaving it unattended.
- * Before servicing the appliance or replacing lamps, unplug the machine.

IMPORTANT SAFETY INSTRUCTIONS

When using this machine, basic safety precautions should always be followed including the following.
Read all instructions before using the machine.



DANGER

– To reduce the risk of electric shock:

- The machine should never be left unattended when plugged in. Always unplug the machine from the electric outlet immediately after using and before cleaning.
- Always unplug before relamping. Replace bulb with the same type rated 15 watts. Be sure to replace the face plate which covers the light bulb before operating the machine.



WARNING

– To reduce the risk of burns, fire, electric shock or injury to persons:

- Be sure that the electrical voltage of the electric outlet (wall receptacle) is the same as the rated voltage of the motor.
- Use this machine only for its intended use as described in this Operator's Guide. Use only attachments recommended by the manufacturer as contained in the Operator's Guide.
- To disconnect, turn all controls to the off ("0") position, then remove plug from outlet.
- Disconnect the power line plug from the socket outlet or switch the machine off when making any adjustments in the needle area, such as threading needle and loopers, changing needle, changing throat plate or changing presser foot, etc.
- Always unplug the machine from the electrical outlet when removing covers, lubricating, or when making any other user servicing adjustments mentioned in the Operator's Guide
- Do not attempt to adjust the motor belt. Contact your nearest Service Center should any adjustment be required.
- Do not unplug by pulling on cord. To unplug, grasp the plug, not the cord.
- Handle the foot controller with care and avoid dropping it on the floor. Be sure not to place anything on top of it.
- Always use the proper throat plate. The wrong plate can cause the needle to break.
- Do not use bent needles.
- When sewing, keep fingers away from all moving parts. Special care is required around the sewing machine needle.
- Do not pull or push fabric while stitching. It may deflect the needle causing it to break.
- Use only the handle to lift and move the machine.
- Never operate the machine if it has a damaged cord or plug, if it is not working properly, if it has been dropped or damaged, or dropped into the water. Return the machine to the nearest authorized dealer or Service Center for examination, repair, electrical, or mechanical adjustment.
- Never operate the machine with any air openings blocked. Keep ventilation openings of the machine and foot controller free from the accumulation of lint, dust and loose cloth.
- Never drop or insert any object into any opening.

- * Do not use outdoors.
- * Do not operate where aerosol (spray) products are being used or where oxygen is being administered.
- * Do not allow to be used as a toy. Close attention is necessary when the machine is used by or near children.
- * Do not expose the machine or machine plastic case to sunlight directly. Also, do not keep it in a very warm or damp place.
- * Do not touch the machine, foot controller and power line cord with wet hand, wet cloth or with anything wet.
- * Do not connect power line cord to one of the many cords connected to one power outlet with adapters.
- * Use machine on flat and stable table.
- * Be sure to close the cylinder cover and looper cover before operating the machine.
- * Keep presser foot and needles away from children's reach.
- * Be sure the light bulb has cooled off before changing with a new one.
- * Do not dismantle or modify the machine yourself.
- * Be sure to turn off the power switch and disconnect the power line plug before caring for your machine as instructed in the operator's guide.

SAVE THESE INSTRUCTIONS

Servicing should be performed by an authorized service representative.

This product is intended for household use.

FOR EUROPEAN AND SIMILAR TERRITORIES:

Machines for Great Britain and some other countries having similar wiring standards are shipped from the factory without a plug for connection to the mains. The wires in this mains lead are colored in accordance with the following code.

Blue: neutral (N) Brown: live (L)

As the colors of the wires in the mains lead of this appliance may not correspond with the colored markings identifying the terminals in your plug, proceed as follows:

The wire which is colored blue must be connected to the terminal which is marked with the letter N or colored black. The wire which is colored brown must be connected to the terminal which is marked with letter L or colored red. If a 13 Amp. (BS 1363) plug is used, a 3 Amp. fuse must be fitted, or if any other type of plug is used, a 5 Amp. fuse must be fitted either in the plug or adaptor or at the distribution board.

Neither cord is to be connected to the earth terminal of a three-pin plug.

CONTENTS

	Page		Page
1. Selection of Stitches	5	21. Suggested Tension Setting	29
2. Handy Reference Chart	6	1) 3-Thread Overlock	29
3. Accessories	7	2) 3-Thread Flatlock	30
4. Needle Information	7	3) 3-Thread Wrapped Edge Overlock	31
5. Principal Parts	8	4) 4-Thread Ultra Stretch Mock Safety Stitch	32
6. How to Open Looper Cover.....	9	22. How to Sew a Rolled Hem	33
7. Principal Parts Behind Looper Cover.....	9	1) 3-thread standard rolled hem stitching	34
8. Preparation Prior to Sewing	9	2) 3-thread upper looper thread wrapped	
9. Preparation for Threading	10	rolled hem stitching	34
•Setting up the thread guide holder	10	23. Stitch Variations and Sewing Techniques	36
10. How to Remove and Insert Needles	11	•How to sew a flatlock decorative seam	36
•To remove needle(s)	11	•How to sew an overlock blind hem	38
•To insert needle(s)	11	•How to sew pin tucks	38
11. Threading the Machine	12	•Turning square corners	39
•Threading diagram	12	•Pin placement	40
•Understanding the color code	12	•Securing the thread chain	40
•To thread the machine correctly	12	•How to reinforce a seam	41
1) Threading the upper looper (Orange)	12	•Braiding by chaining off	41
2) Threading the lower looper (Yellow)	14	24. Machine Maintenance	42
3) Threading the right needle (Green)	16	•Cleaning the machine	42
4) Threading the left needle (Blue)	18	•Oiling the machine.....	42
•Important threading information	19	•How to replace the stationary knife	43
12. How to Change Threads / Tie on Method	20	•How to exchange light bulb	44
13. How to Adjust the Stitch Length	21	25. Troubleshooting Chart	45
14. How to Adjust the Seam Width	21	26. Relationship between Cloth, Thread and Needle	46
•Width adjustment by changing needle position	21	27. Specification	47
•Width adjustment with adjustment knob	21		
15. How to Adjust the Presser Foot Pressure	22		
16. Differential Feed	23		
•Gathered overedge	23		
•Stretch overedge	23		
17. How to Disengage Movable Upper Knife	25		
18. Free Arm Sewing (Tubular Work)	26		
19. Standard Overedge and Rolled Hem Stitching	27		
•To sew standard overedge	27		
•To sew rolled hem	27		
20. Chaining Off and Test Sewing	28		

1. SELECTION OF STITCHES

This machine is capable of producing various types of stitches according to the combination of needle positions, threading methods, tension adjustment.

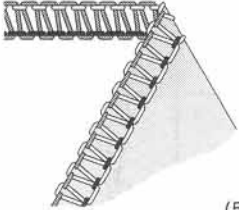
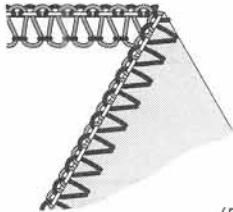
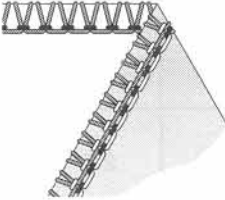
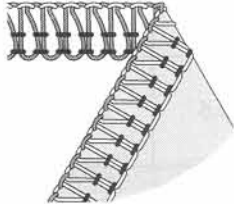



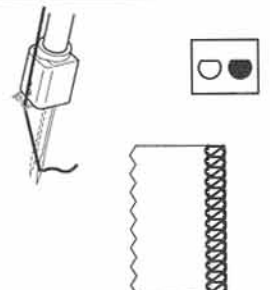
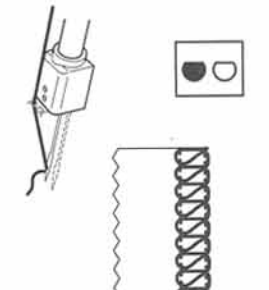

Stitch Type			Reference Pages
1. Three-thread Overlock	 <p style="text-align: right;">(504)</p>	1-needle 3-thread stitch is used for overedging and seaming on common fabrics. Also, a 3.5mm and 5.7mm overlock seam width can be obtained by changing the needle position.*	29
2. Three-thread Flatlock	 <p style="text-align: right;">(505)</p>	1-needle 3-thread stitch is used for butted or lapped seams and ornamental stitching with decorative thread. Also, a 3.5mm and 5.7mm flatlock width can be obtained by changing the needle position.*	30
3. Three-thread Wrapped Edge Overlock		1-needle 3-thread stitch is used for sewing narrow rolled hems or ornamental edges. Also, a 3.5mm and 5.7mm wrapped overlock seam width can be obtained by changing the needle position.*	31
4. Four-thread Stretch Mock Safety Stitch	 <p style="text-align: right;">(514)</p>	2-needle 4-thread stitch which is ideal for medium to heavy weight stretchy fabrics such as double knits and swim wear.	32

* Depending on the needle positions used, this machine can sew 3-thread standard width 3.5mm overedge and a 5.7mm wide overedge seams.

Also, for overedging heavyweight fabrics, the seam width can be increased still more by turning the overedge seam width adjustment knob. (See page 21)

Overedge width	3.5mm	5.7mm
Needle used	Overedge right needle	Overedge left needle
Needle thread tension dial	Green	Blue
		

2. HANDY REFERENCE CHART

Stitch Type		Needle Positions	Tension Dial; Numbers shown are average settings on medium weight fabric with standard #80 polyester spun thread				Page
			Blue	Green	Orange	Yellow	
1	Three - Thread Overlock (504)	3.5mm 		3.0	2.5	2.0	29
		5.7mm 	2.5		2.5	2.0	
2	Three - Thread Flatlock (505)	3.5mm 		0.5	5.5	5.5	30
		5.7mm 	0.5		5.0	6.0	
3	Three - Thread Wrapped Edge Overlock	3.5mm 		3.0	0.5	7.0	31
		5.7mm 	3.0		0.5	7.0	
4	Four - Thread Ultra-Stretch Mock Safety Stitch (514)		2.5	2.0	2.5	2.0	32

The thread tension becomes tighter as the dials are turned to higher numbers. The tension settings shown on this page as well as throughout the operator's manual are suggested guides. Adjust thread tensions to suit the fabric and size of thread used. For best results make tension adjustments in small increments of no greater than half a number at a time.

3. ACCESSORIES

Accessories are contained in the accessory case in the cloth plate.

	644 / 654
1 Needle set	1
2 Screw driver (small size)	1
3 Tweezers	1
4 Hex-head wrench	1

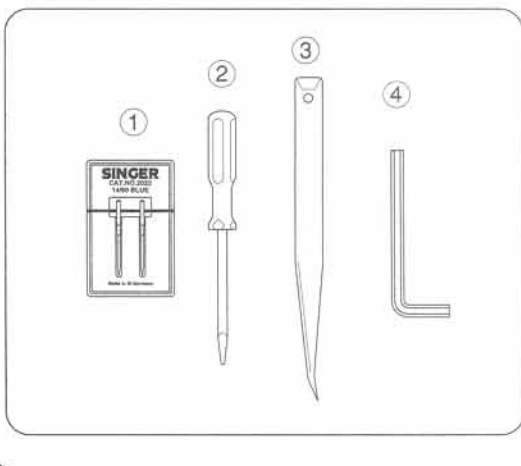
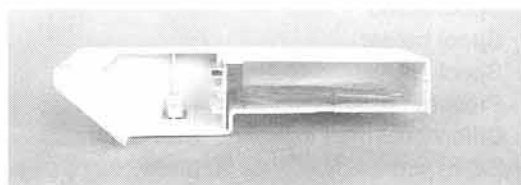
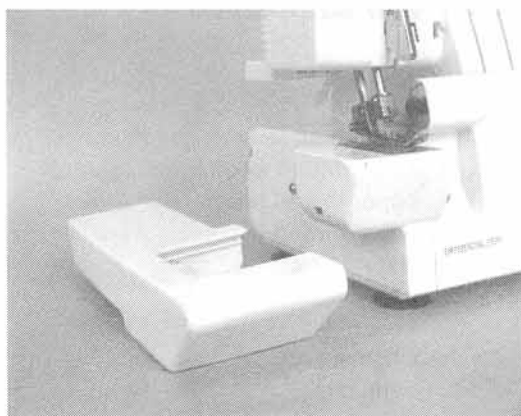

4. NEEDLE INFORMATION

- Singer needle #2022 size 90/14 is furnished with the machine.
- In an emergency, standard Singer needle #2020 may be used.

However, unless the suggested tension setting is readjusted, skipping of the stitches may occur.

	Singer needle #2022
Sizes available	80/11 90/14

5. PRINCIPAL PARTS

- 1 Thread guides and holder
- 2 Handle
- 3 Left needle thread tension dial (blue)
- 4 Right needle thread tension dial (green)
- 5 Upper looper thread tension dial (orange)
- 6 Lower looper thread tension dial (yellow)
- 7 Throat plate
- 8 Cloth plate
- 9 Looper cover
- 10 Power & light switch
- 11 Stitch length dial
- 12 Hand wheel
- 13 Spool stand
- 14 Spool holder
- 15 Spool pin
- 16 Presser bar lifter
- 17 Differential feed adjusting lever knob
- 18 Seam width finger support plate

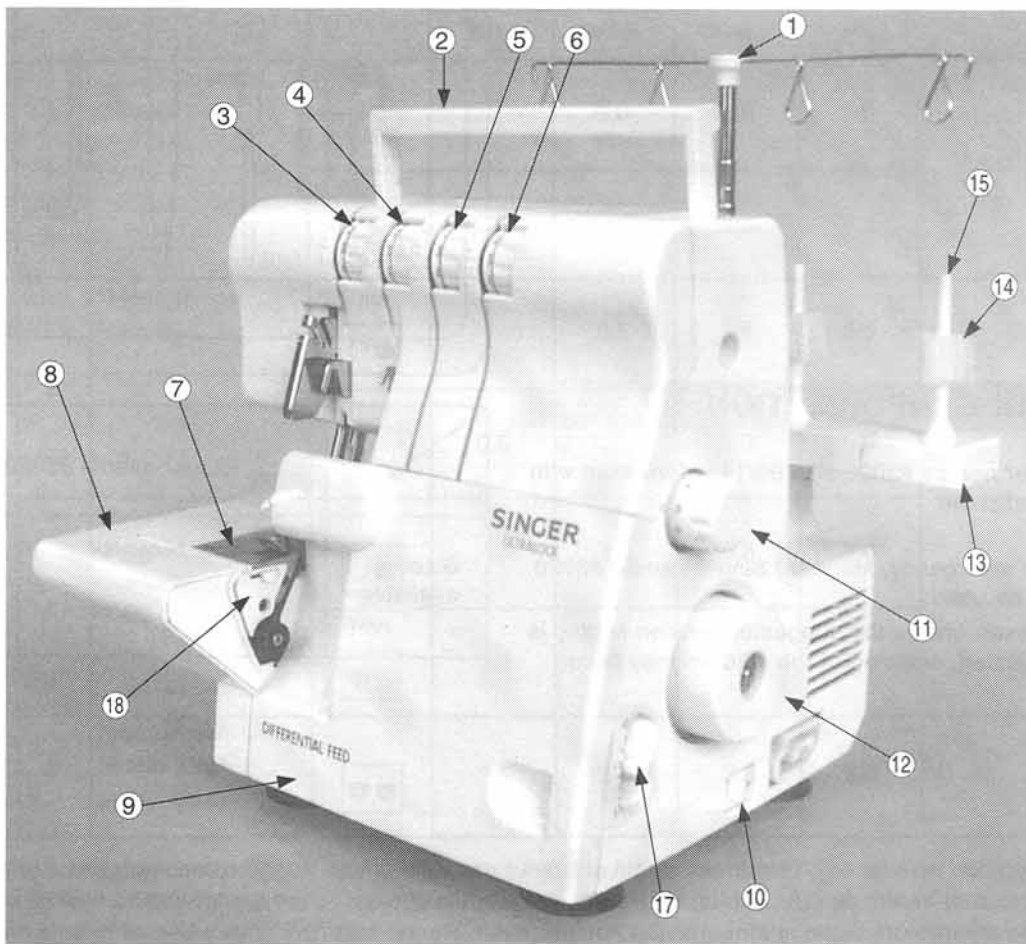

6. HOW TO OPEN LOOPER COVER



Caution :
Be sure to turn off power switch.

- Push the cover to the right as far as it will go 1 .
- Pull cover down toward you 2 .



Caution:
Be sure looper cover is closed when sewing.

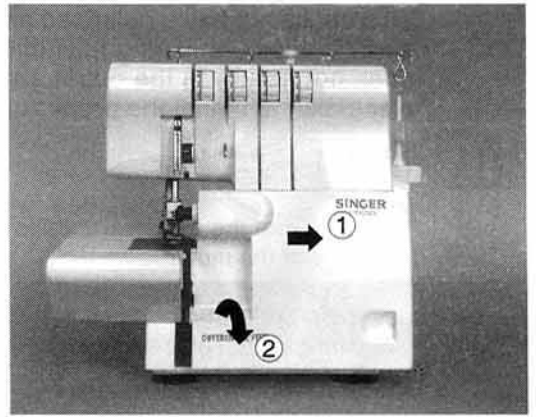

7. PRINCIPAL PARTS BEHIND LOOPER COVER

- 1 Upper looper
- 2 Movable upper knife
- 3 Presser foot
- 4 Stationary lower knife
- 5 Lower looper
- 6 Seam width finger knob
- 7 Seam width adjustment knob

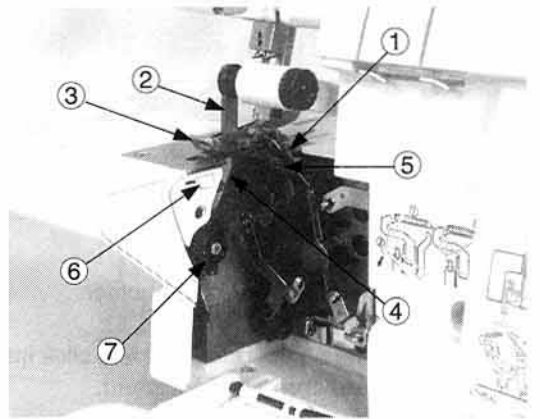

8. PREPARATION PRIOR TO SEWING

- Connect the controller / electric plug 1 to the machine receptacle 2 .
- Plug power line 3 into electric outlet 4 .
- Power Switch: Push "–" mark side to turn "ON".
Push "O" mark side to turn "OFF".
- To run the machine and control the speed, press the controller.
- The harder you press, the faster the machine will sew.
- To stop the machine from sewing, remove your foot from the controller.

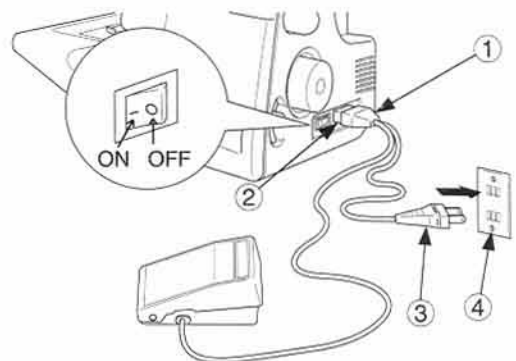

WARNING:

Use only foot controller provided with this machine. (YC-482 for U.S.A. & CANADA only)
Be sure to make reference to "Warning" on following page.

POLARIZED PLUG INFORMATION (FOR U.S.A. & CANADA ONLY)

This appliance has a polarized plug (one blade wider than the other). To reduce the risk of electric shock, this plug is intended to fit in a polarized outlet only one way. If the plug does not fit fully in the outlet, reverse the plug. If it still does not fit, contact a qualified electrician to install the proper outlet. Do not modify the plug in any way.



Warning:

- * Be sure that the electrical voltage of the electric outlet (wall receptacle) is the same as the rated voltage of the motor.
- * Handle the foot controller with care and avoid dropping it on the floor. Be sure not to place anything on top of it when not in use.
- * Disconnect the power line plug from the electric outlet when changing needles, presser feet or throat plates, or when leaving the machine unattended. This eliminates the possibility of starting the machine by accidentally pressing the controller.

9 . PREPARATION FOR THREADING

Setting Up the Thread Guide Holder

- This machine is shipped with the thread guide holder in the lowered position.
- Fully extend the thread guide holder.
- The two joints on the telescope will click into place when they are correctly positioned.
- Center the thread guides above the spool pins.
- Place thread over the cone adapters on the spool pins.

Note: If the machine is threaded, straighten the threads to prevent tangling.

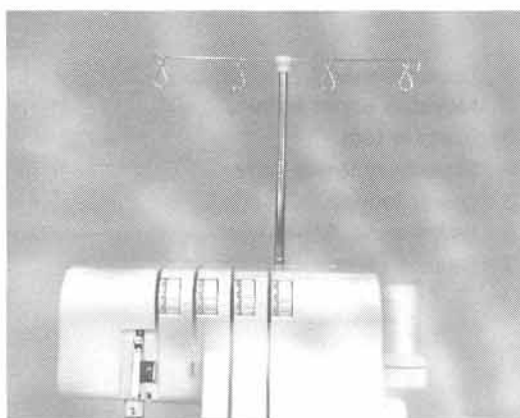

10. HOW TO REMOVE AND INSERT NEEDLES

To Remove Needle(s)



Caution :
Be sure to disconnect the machine from the electric outlet before removing needle(s).

- Turn the hand wheel toward you until the needle is at its highest position.

- Loosen, but do not remove the needle set screw with the small screwdriver.

- 1 Left needle set screw
- 2 Right needle set screw
- 3 Left needle
- 4 Right needle

- Remove the needle(s).

To Insert Needle(s)



Caution :
Be sure to disconnect the machine from the electric outlet before replacing needle(s).

- Hold the needle with the flat surface to the back.
- Insert the needle into the needle clamp as far as it will go.
- Securely tighten the needle set screw.

Note: *This machine uses #2022 needles. Refer to page 17 for additional needle information.

- * Remove the cloth plate if you find it difficult to remove and replace the needle.

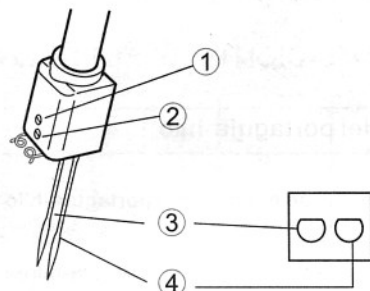
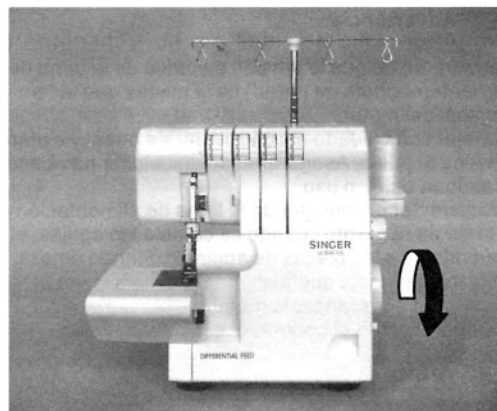
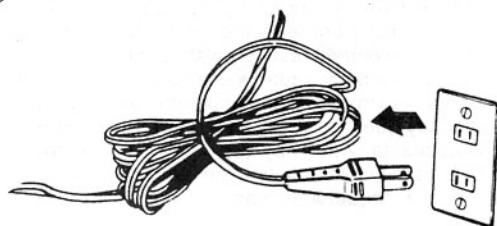

Flat surface to the rear
Superficie plana hacia atrás.
Talon plat vers l'arrière

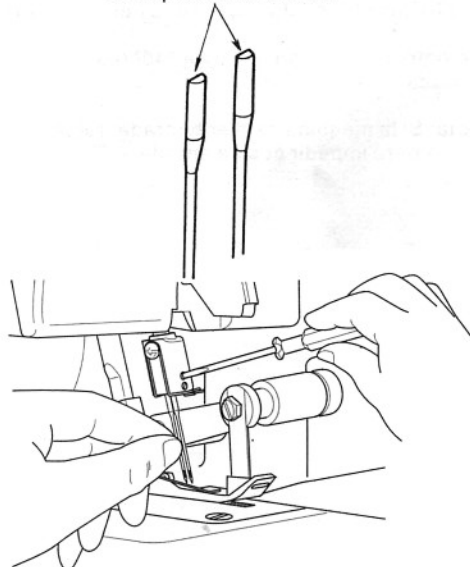

11. THREADING THE MACHINE

Threading Diagram

- A color coded threading diagram is located inside the looper cover for quick reference.
- Thread the machine in the order 1 to 4 as shown.

Understanding the Color Code

- 1 Upper looper thread Orange
- 2 Lower looper thread Yellow
- 3 Right needle thread Green
- 4 Left needle thread Blue

To Thread The Machine Correctly



Caution :
Be sure to turn off power switch.

1) Threading the Upper Looper (Orange)

- Thread the upper looper as indicated 1 ~ 8 .

- Pass thread from back to the front through the thread guide 1 .

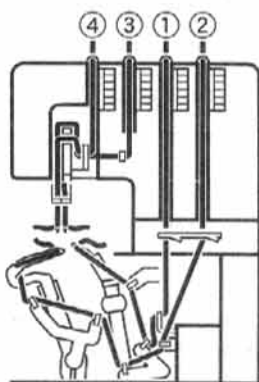

②

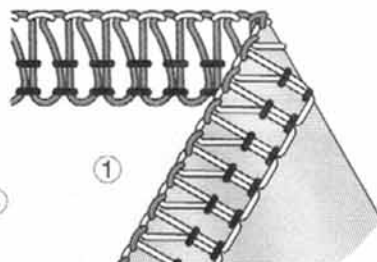

③

④

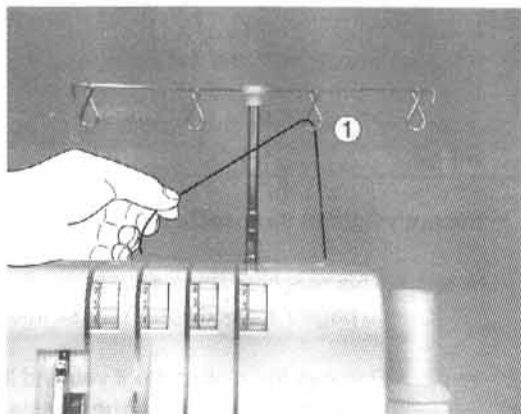
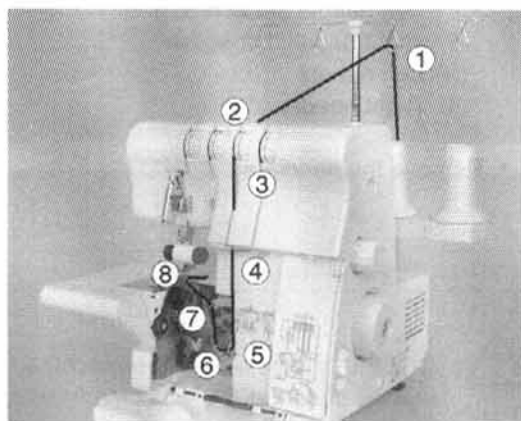

- Thread the top cover thread guide by pulling the thread downward until it slips under thread guide 2 .

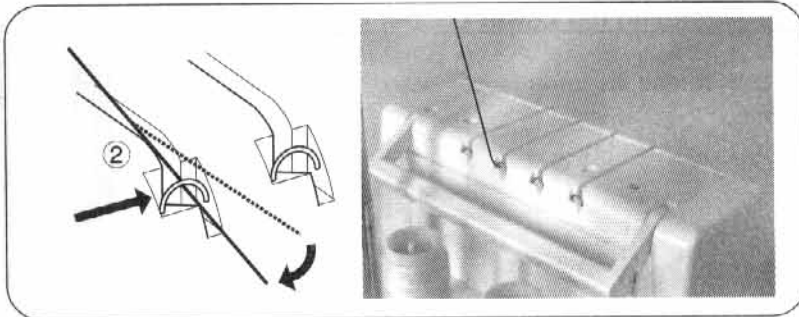

- While holding thread with finger, pass it between the tension discs and pull thread down to make certain it is properly located in between the tension discs 3 .

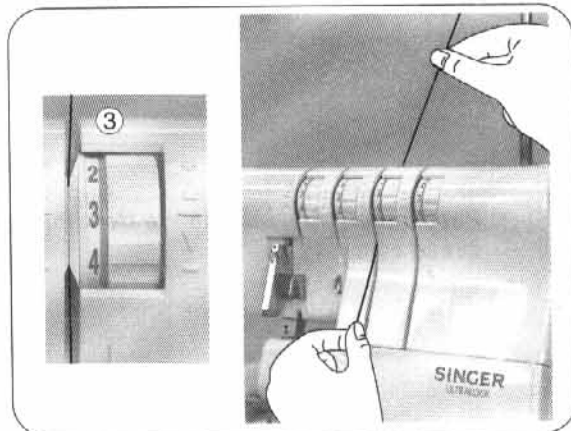

- Thread the looper area of the machine following the orange color coded thread guides (4 ~ 7).
- Thread the hole in the upper looper from front to back 8 .

Note: Use of tweezers provided in the accessory set to aid in threading the looper.

- Pull about 10cm (4 inches) of thread through the looper and place to the back of the throat plate.

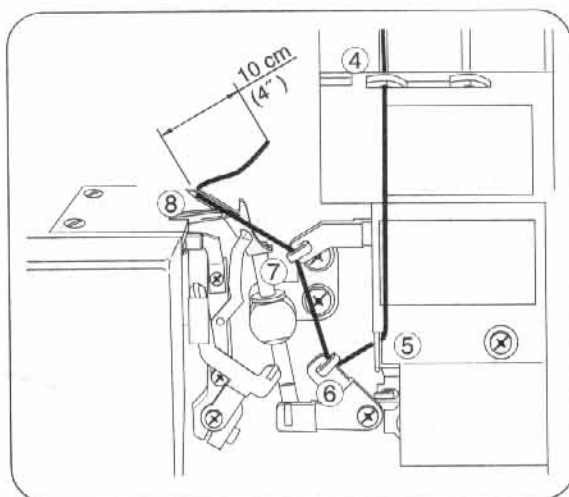

2) Threading the Lower Looper (Yellow)

- Thread the lower looper as indicated 1 ~ 9 .

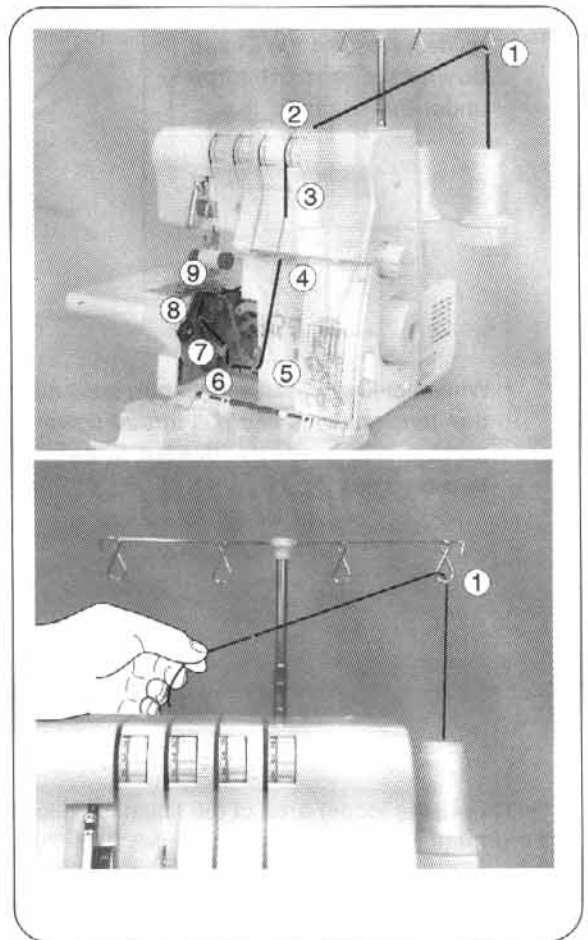

- Pass thread from back to the front through the thread guide 1 .

- Thread the top cover thread guide by pulling the thread downward until it slips under thread guide 2 .

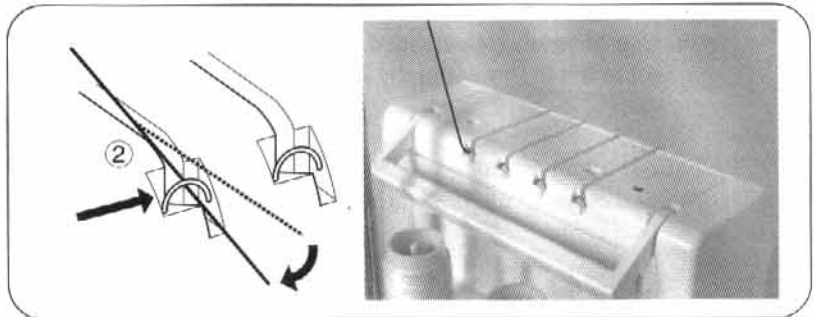

- While holding thread with finger, pass it between the tension discs and pull thread down to make certain it is properly located in between the tension discs 3 .

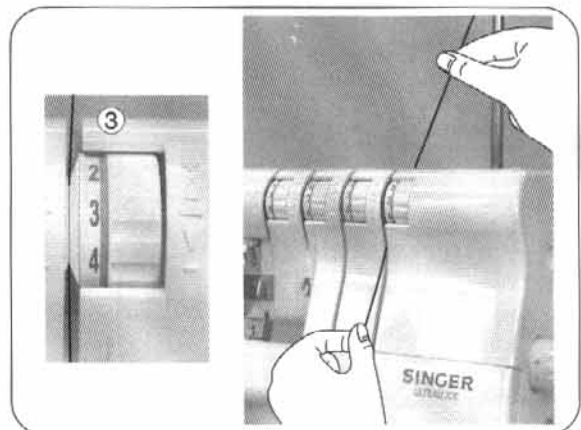

- Turn the hand wheel toward you until the lower looper is at the far right.

- Thread the looper area of the machine following the yellow color coded thread guides 4 ~ 7 .

Note: Use the tweezers provided in the accessory set to aid in threading the looper.

- Grasp the thread with the tweezers 4 cm (1-1/2 inches) from thread guide 7.
- Place the thread with the point of the tweezers slightly under and to the left of threading guide 8.
- Pull the thread up and into thread guide 8.

- Pass the thread behind and over the top end of left looper 9-A.
- Then pull it downward gently so that it will slip into the slot in the looper 9-B.

- Pick up the thread and pass it through the hole in the end of the looper 10 .

Note : Use the tweezers provided in the accessory set to aid in threading the looper.

- The thread should be positioned in the groove of the lower looper.
- Pull about 10cm (4 inches) of thread through the looper and place it over the top of the upper looper and to the back of the throat plate.

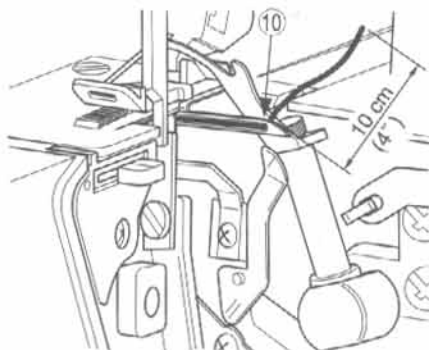
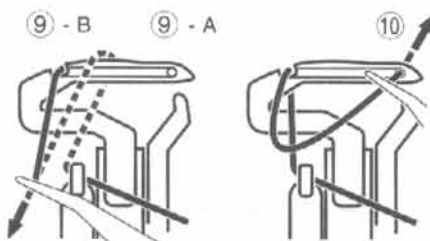
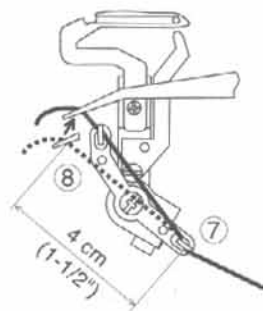
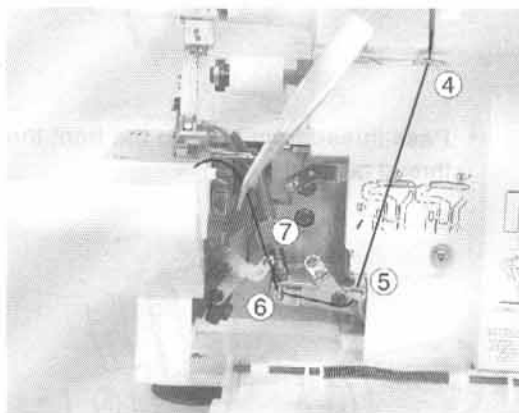

3) Threading the Right Needle (Green)

- Thread the right needle as indicated 1 ~ 8.

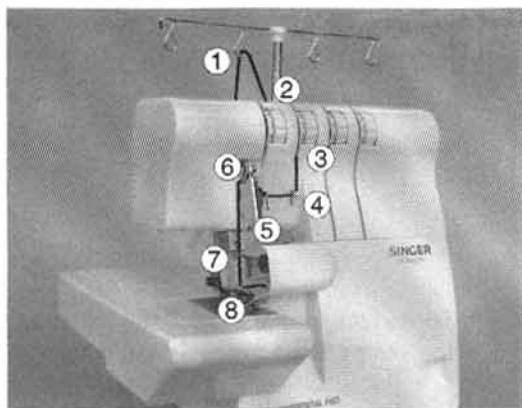

- Pass thread from back to the front through the thread guide 1 .

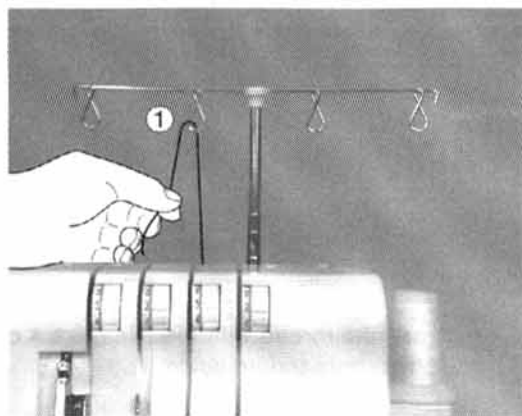

- Thread the top cover thread guide by pulling the thread downward until it slips under thread guide 2.

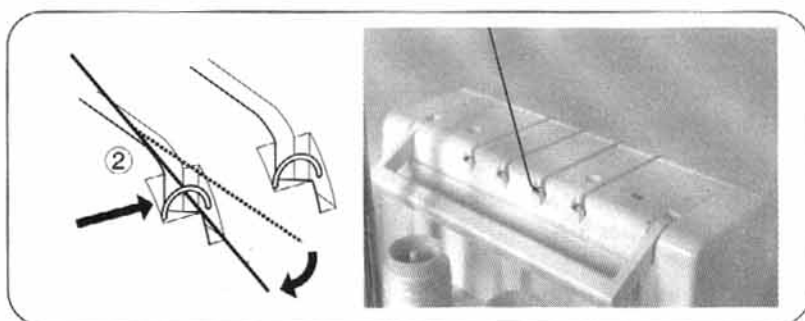

- While holding thread with finger, pass it between the tension discs and pull thread down to make certain it is properly located in between the tension discs 3 .

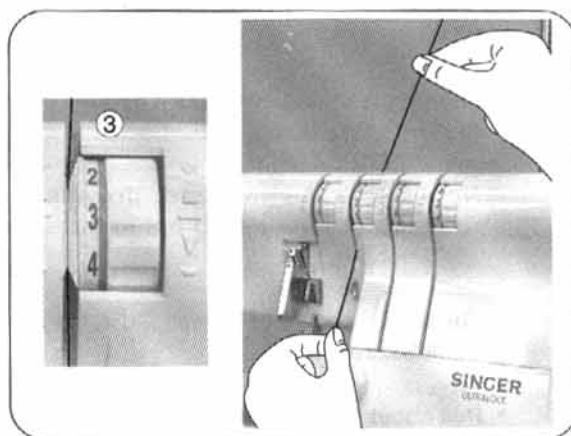

- Continue to thread points 4 ~ 6 .

Note: Be sure to pass the thread through upper thread path of the thread guide 6 .

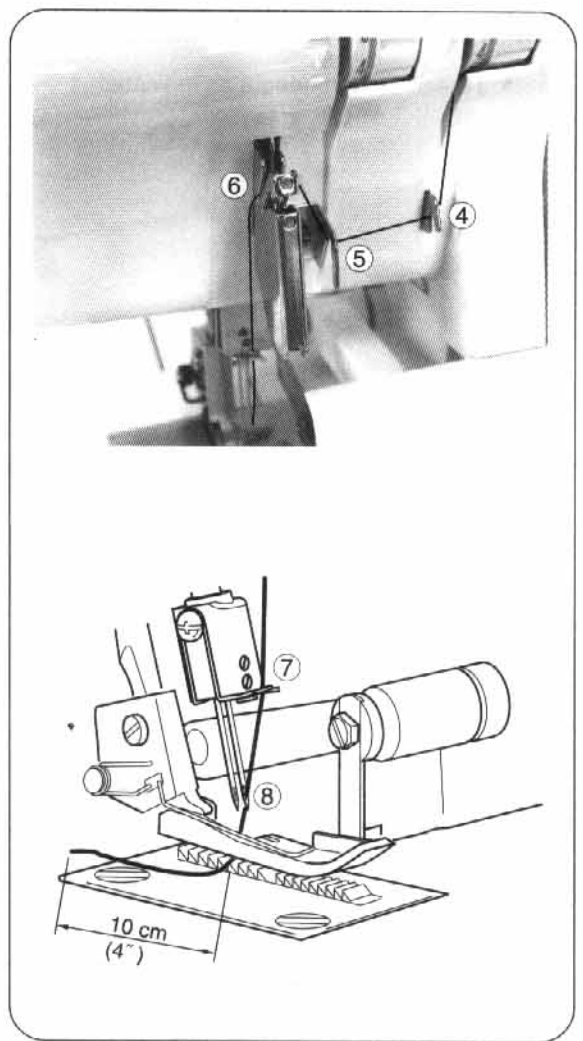

- Thread the eye of the right needle 8 .

Note: Use of tweezers in the accessory set will make needle eye threading easy.

- Draw about 10cm (4 inches) of thread through needle eye to hang free.
- Place the thread to the back, under the presser foot.

4) Threading the Left Needle (Blue)

- Thread the left needle as indicated 1 ~ 7.

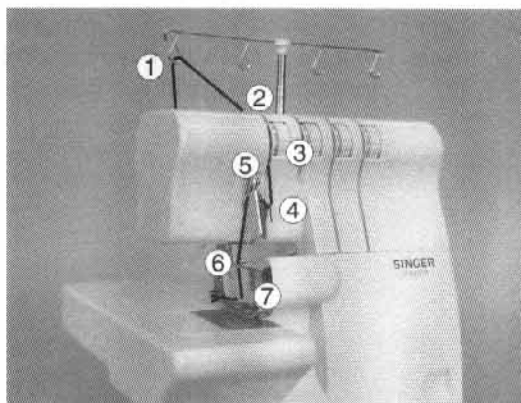

- Pass thread from back to the front through the thread guide 1.

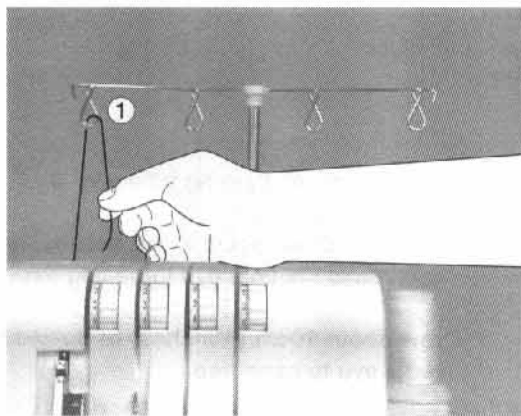

- Thread the top cover thread guide by pulling the thread downward until it slips under thread guide 2.

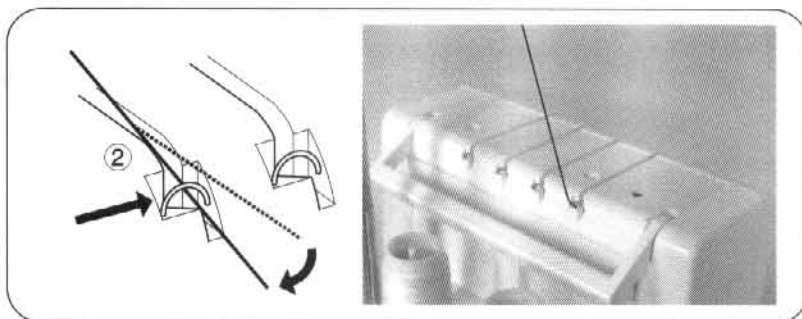

- While holding thread with finger, pass it between the tension discs and pull thread down to make certain it is properly located in between the tension discs 3.

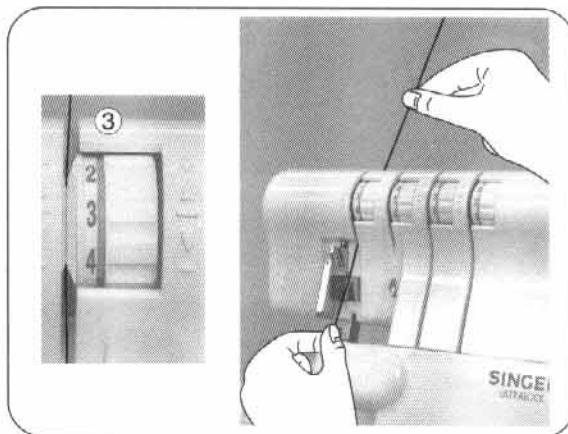

- Continue to thread points 4 ~ 5 .

Note: Be sure to pass the thread through lower thread path of the thread guide 5 .

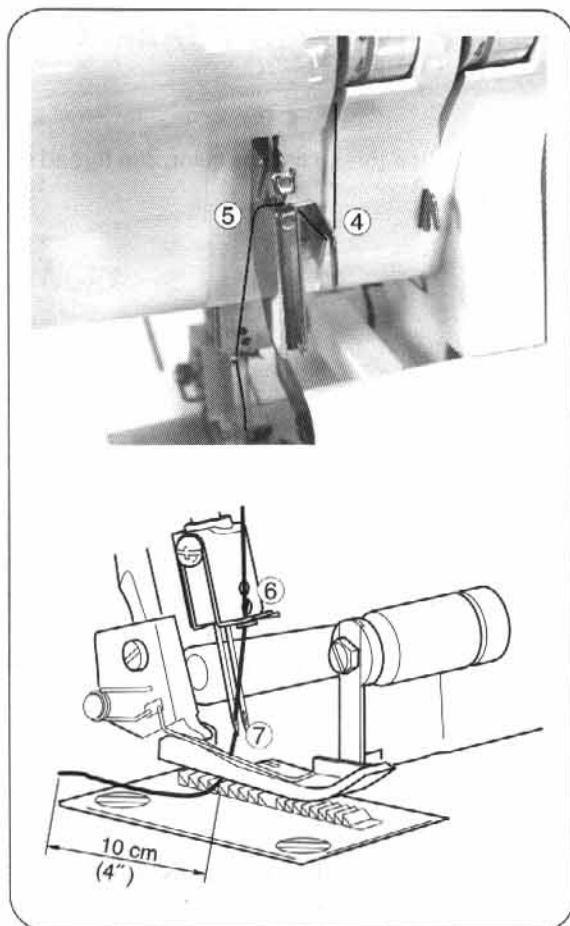

- Thread the eye of the left needle 7 .

Note: Use of tweezers in the accessory set will make needle eye threading easy.

- Draw about 10cm (4 inches) of thread through needle eye to hang free.
- Place the thread to the back, under the presser foot.

Important Threading Information

- Always thread the needle(s) last to prevent misthreading the lower looper.
- If the lower looper should come unthreaded;
 - 1) Unthread the needle(s)
 - 2) Thread the lower looper
 - 3) Thread the needle(s)

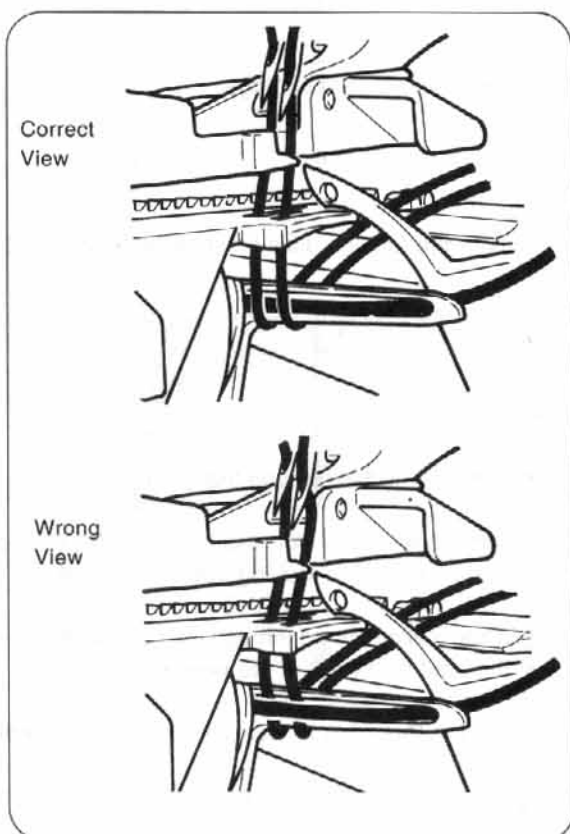

12. HOW TO CHANGE THREADS / TIE ON METHOD

- To change thread type or color, clip thread near the spool.

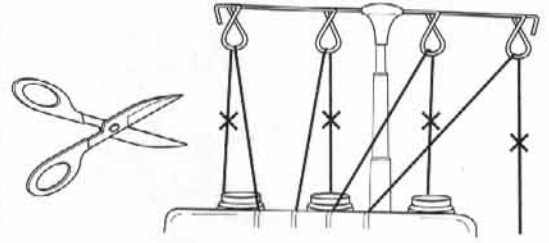

- Place new thread on stand.
- Tie new thread and old thread ends together.
- Clip thread tails to 2 ~ 3cm (1 inch) length. If clipped too short, threads may come untied.

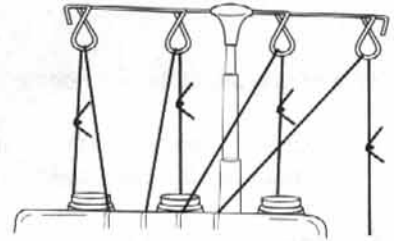

- Firmly pull both thread to test knot security.



- Note tension dial settings.

- Turn the tension dials down until the dial stops.

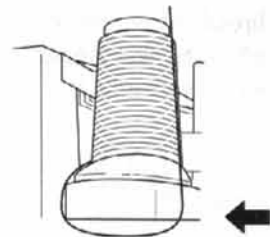

- Pull the threads through the machine one at a time.

- If threads do not pull easily, check for tangles on thread guides or looping under thread stand.

- When pulling thread through the needle, STOP when the knot is in front of the needle.

- Cut the thread, and insert it through the needle.

- Return tension dials to previous settings.

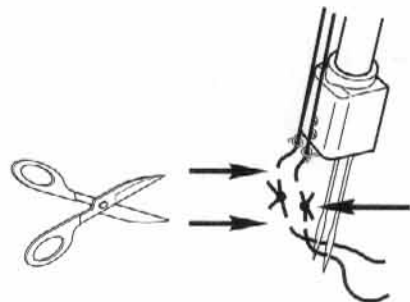

13. HOW TO ADJUST THE STITCH LENGTH

- The stitch length dial should be set on the 3 mm (1/8 inch) setting for most sewing conditions.
- Adjust the stitch length to 4mm (5/32 inch) when sewing heavy weight fabrics.
- Adjust the stitch length to 2mm (5/64 inch) when sewing light weight fabrics to obtain excellent seams without puckering.

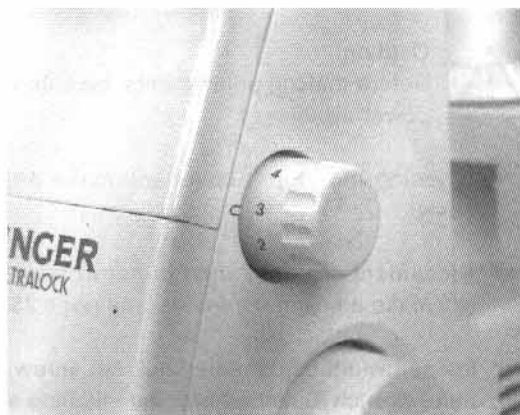

14. HOW TO ADJUST THE SEAM WIDTH

- Overedge seam width can be achieved by repositioning the needle position and also with the width adjustment knob.

Width Adjustment by Changing Needle Position

- Overedge seam width can be adjusted by changing the needle position.
 - When only left needle is used 5.7 mm (7/32 inch)
 - When only right needle is used 3.5 mm (9/64 inch)

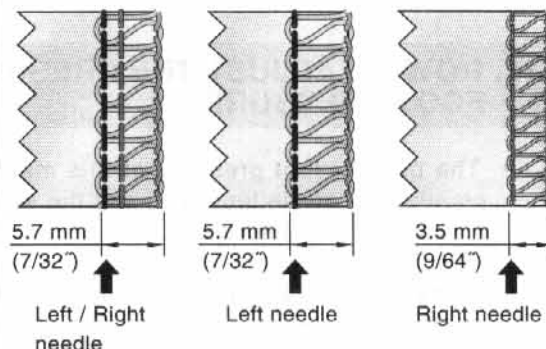

Width Adjustment with Adjustment Knob

- Use of width adjustment knob will permit further adjustment within the width range shown below.
 - When only left needle is used 5.2 ~ 6.7 mm (13/64 ~ 17/64 inch)
 - When only right needle is used ... 3.0 ~ 4.5 mm (1/8 ~ 11/64 inch)

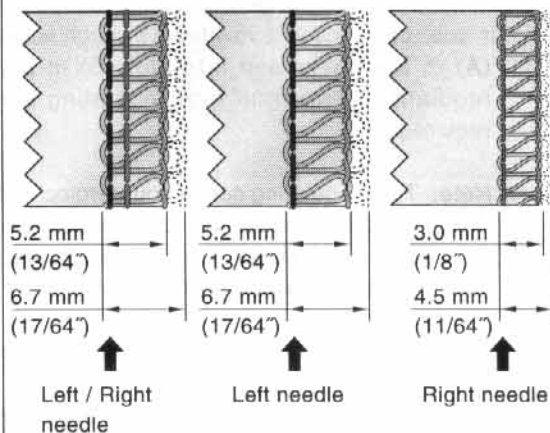

Width adjustment knob



Caution:

Before making adjustments, be sure to turn off power switch

- Opening the looper cover will make adjustment easier.
- Placement of upper knife in nonworking position will make adjustment easier. (see page 25)
- Loosen width adjustment knob set screw with hex head wrench furnished with the machine and using the graduations on the throat plate as a guideline, set edge (A) of the seam width finger support plate to desired seam width. Then firmly tighten the set screw.



Caution:

Always close looper cover before operating machine.

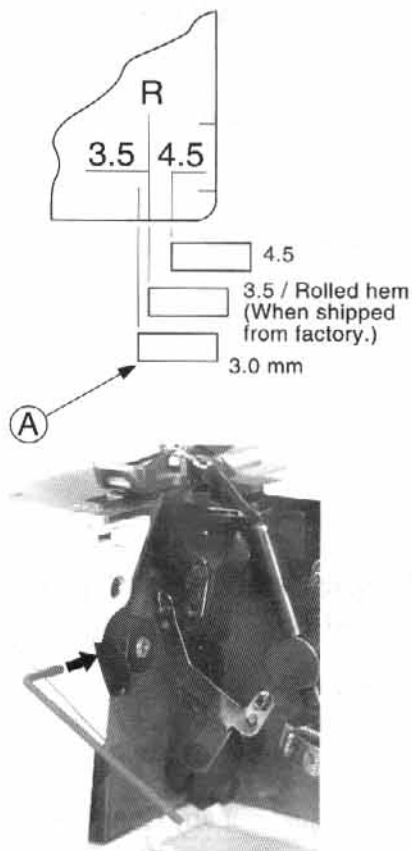

15. HOW TO ADJUST THE PRESSER FOOT PRESSURE

- The presser foot pressure of this machine is preadjusted at the factory to suit the sewing of medium weight fabrics.
- Most of the materials do not require adjustment of presser foot pressure however, there are some instances where adjustment is necessary when sewing lightweight and heavyweight fabrics.
- In such case, insert screwdriver through access hole (A) in top cover and into slot (B) in pressure regulating screw and turn regulating screw as required.

Note: Turn regulating screw counterclockwise until it stops against the top cover. Then turn screw clockwise 6 turns which will be the standard presser bar pressure.

- For lightweight fabric ... Decrease the pressure
- For heavyweight fabric ... Increase the pressure

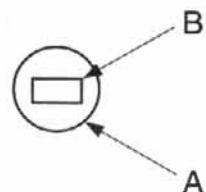
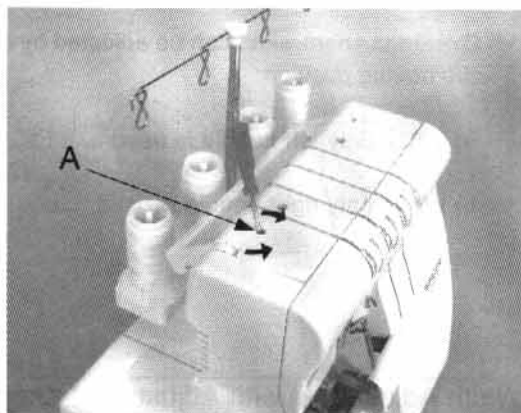

16. DIFFERENTIAL FEED

- Differential feed is a system which “stretches” or “gathers” the fabric, when amount of feed of front feed dog in relation to the rear feed dog is changed.
- The differential feed ratio ranges from 1 : 0.7 ~ 1 : 2.0. Adjustment is made by means of the differential feed adjusting lever pictured below.
- Use of differential feed is very effective in overedging stretch fabrics and fabrics cut on the bias.
- Graduation “1.0” differential feed adjusting lever setting for ratio 1:1.

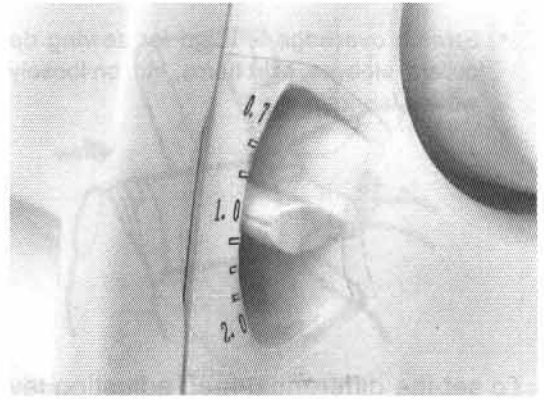

Gathered Overedge

- Gathered overedge is most suited for shirring sleeves, yokes, front and back bodices, skirt hems, etc. in stretch fabrics such as knits and jersey before assembling into garment.

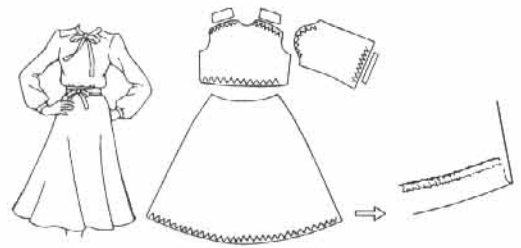

To set the differential feed adjusting lever

- Set differential feed adjusting lever knob below graduation “1.0”. Setting of adjusting lever knob depends on material being sewn as well as the amount of gather therefore set knob to suit the fabric and test sew before sewing your garment.
- When feed regulating dial is set at “3” or over, the amount of feed of the main feed dog will change to “3” automatically when adjusting lever knob is set to 2.0.

Note: For normal overedge stitching, set differential feed adjusting lever knob to graduation “1.0”.

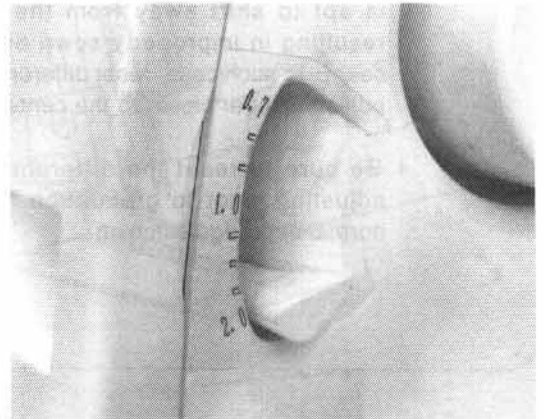

Stretch Overedge

- Stretch overedge is ideal for sewing decorative collars, sleeves, skirt hems, etc. on loosely knit and woven fabrics.

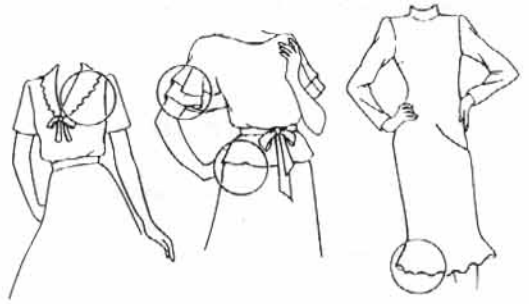

To set the differential feed adjusting lever

- Set differential feed adjusting lever knob above graduation "1.0".

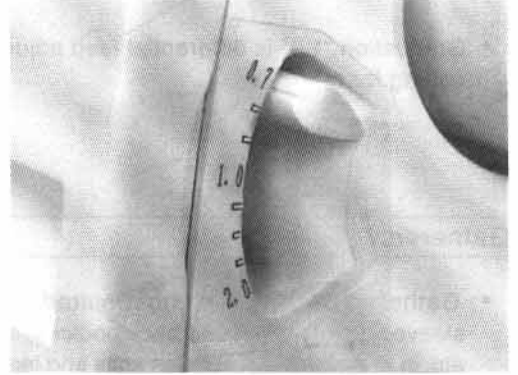

- To sew a seam, apply gentle tension to the fabric by holding the seam lightly in front and back of the presser foot.

Note: * If amount of "stretch" is not correctly set in relation to the fabric being sewn, the fabric is apt to shift away from the needle resulting in improperly sewn overedge seam. In such case, reset differential feed adjusting lever closer to the center mark.

- * Be sure to reset the differential feed adjusting lever to graduation "1.0" for normal overedge stitching.

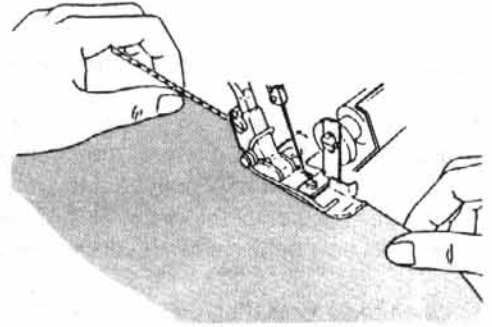

17. HOW TO DISENGAGE MOVABLE UPPER KNIFE



Caution :
Be sure to turn off power switch.

To place movable knife in nonworking position

- Turn handwheel over toward you and raise upper knife to its highest position.
- Open looper cover (page 9).
- Push the movable knife holder to the right as far as it will go.
- Turn the knob away from you until the knife clicks into a horizontal position.

Note: If the knife stops in the up position;

- * Turn the hand wheel toward you until the knife clears the top of the machine.
- * Continue to rotate the knife to the horizontal position.

To place movable knife in working position

- Open looper cover and push the movable knife holder to the right as far as it will go.
- Turn the knob up and toward you until the knife clicks into the working position.



Caution :
Always close looper cover before operating machine.

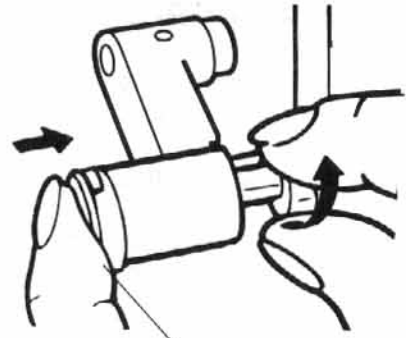

Movable Knife Holder

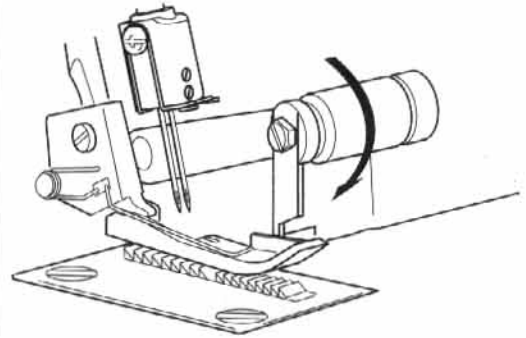
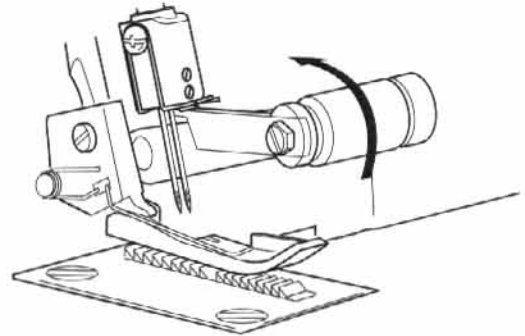

18. FREE ARM SEWING (TUBULAR WORK)

This machine become a free arm machine simply by removing the cloth plate.

To remove the cloth plate

- Slide cloth plate to the left and remove from machine while pressing button (A) located on the underside.

- This is especially suited for sewing hard to reach garment areas such as armholes and overcasting trouser cuffs.
- Place garment over the free arm and sew.

To replace the cloth plate

- Align projection on cloth plate with groove in cylinder cover and slide to the right until tab on cloth plate (front) snaps into slot in cylinder cover.

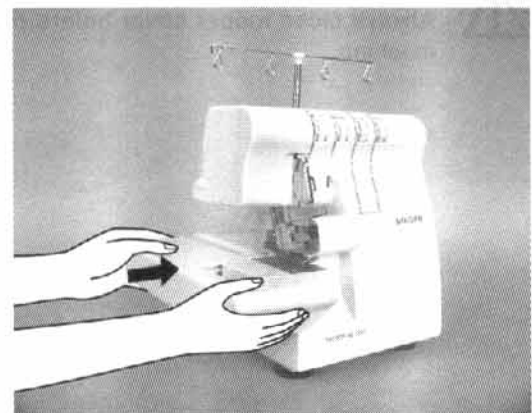
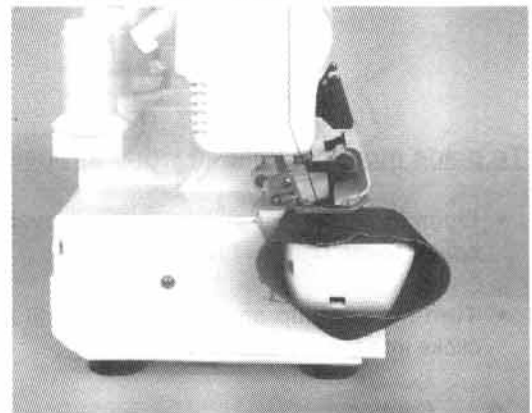
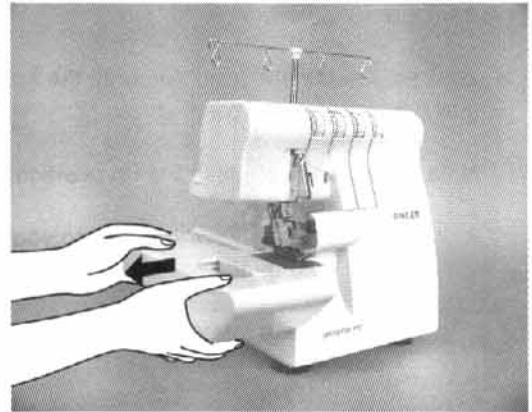
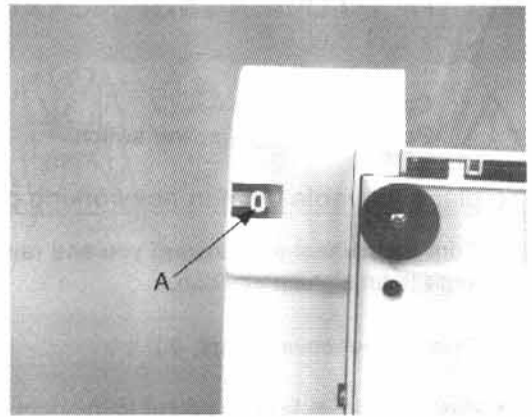

19. STANDARD OVEREDGE AND ROLLED HEM STITCHING

To Sew Standard Overedge

- Set seam width finger knob to **S** to move seam width finger to projected position.

Note: Be sure to push seam width finger knob as far as it will go in the direction of setting **S**.

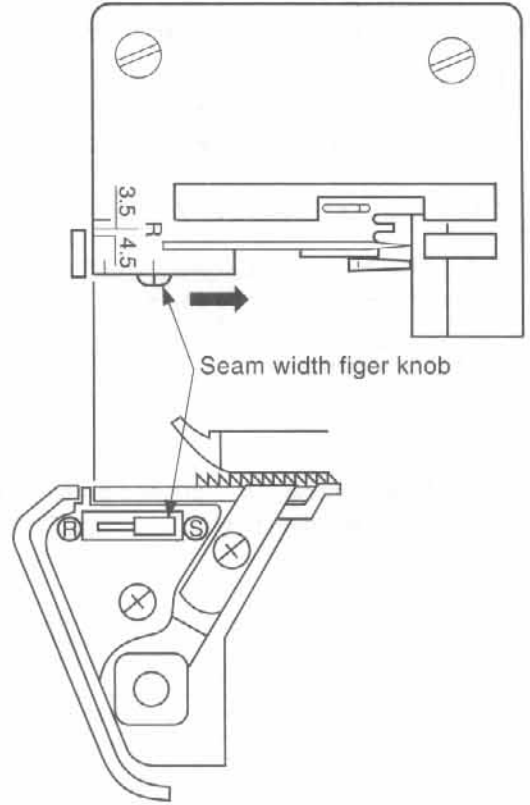

To Sew Rolled Hem

- Set seam width finger knob to **R** to retract the seam width finger.

Note: Be sure to push seam width finger knob as far as it will go in the direction of setting **R**.

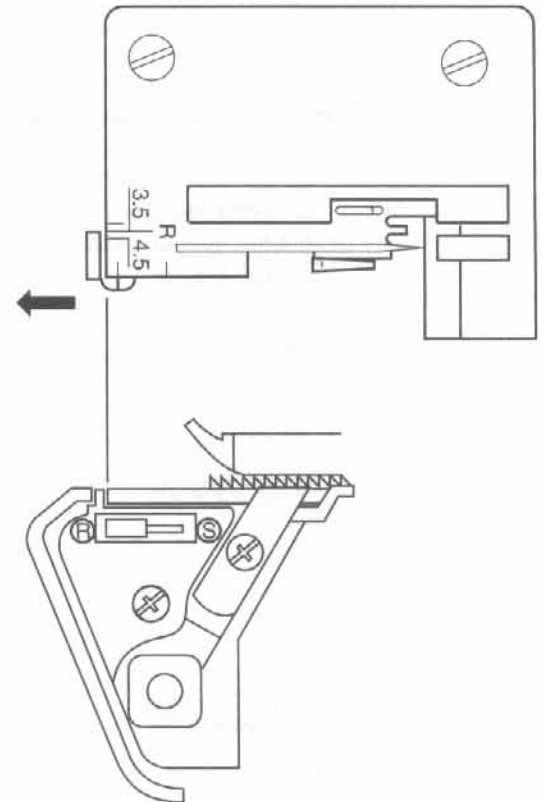

20. CHAINING OFF AND TEST SEWING

- When the machine is completely threaded, bring all of the threads over the throat plate and slightly to the left under the presser foot.
- Hold the threads and apply a slight tension.
- Turn the hand wheel toward you 2 or 3 complete turns to start the thread chain.
- Lower presser foot.
- Continue holding the chain and press on the foot controller until the chain is 5 ~ 7.5cm (2 ~ 3 inches) in length.
- Place fabric under the front of the presser foot and sew a test sample.

Note: Do not pull on the fabric while sewing as this may deflect the needle, causing it to break.

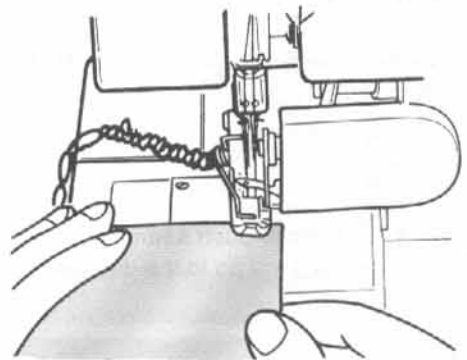
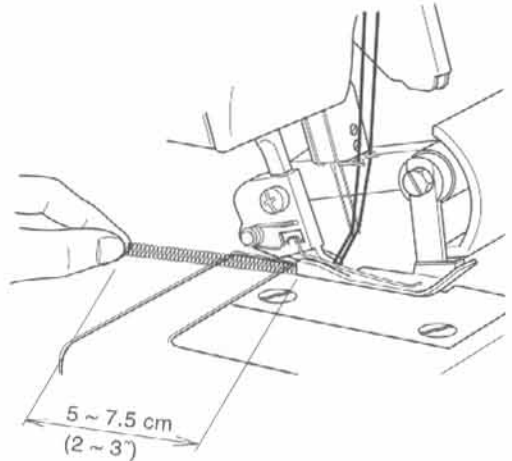
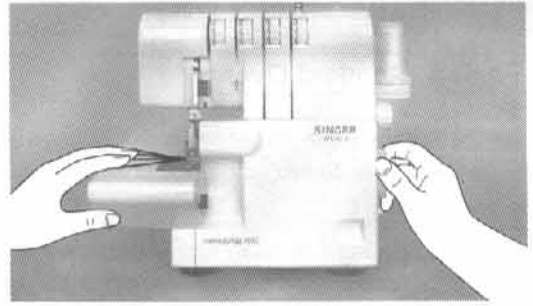

21. SUGGESTED TENSION SETTING

1) 3-thread Overlock

Note: * These are suggested tension settings only.

- * Tension settings are effected by;
 - 1) Type and thickness of fabric
 - 2) Needle size
 - 3) Size, type and fiber content of thread

Correct Balance

- Set Each Tension Dial to Settings Shown at Right and Test Sew on a Sample of Your Fabric

NEEDLE POSITION		
SEAM WIDTH FINGER KNOB	S	
STITCH LENGTH	2 ~ 4	

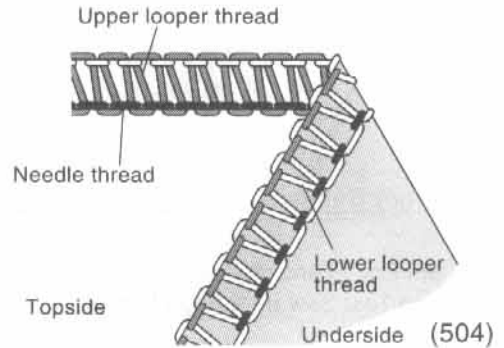

Fabric	Tension Dial			
	Blue	Green	Orange	Yellow
Light weight	1.5		2.0	2.0
Medium weight	2.5		2.5	2.0
Heavy weight	3.0		3.0	2.0

Fabric	Tension Dial			
	Blue	Green	Orange	Yellow
Light weight		2.0	2.0	2.0
Medium weight		3.0	2.5	2.0
Heavy weight		3.5	3.0	2.0

How to Balance

- When the upper looper thread lies on the underside of the fabric;
 - Turn the upper looper thread tension dial (orange) to a higher number.
 - Or, turn the lower looper thread tension dial (yellow) to a lower number.
- When the lower looper thread appears on the top of fabric;
 - Turn the lower looper thread tension dial (yellow) toward a higher number.
 - Or, turn the upper looper thread tension dial (orange) to a lower number.
- When the needle thread is too loose, turn the needle tension dial (blue or green) to a higher number.

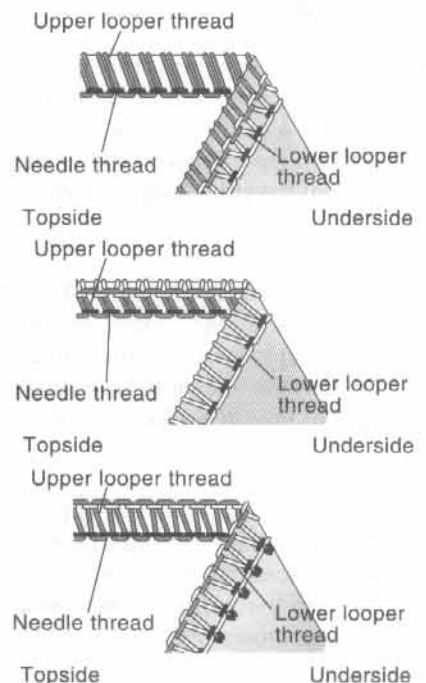

2) 3-thread Flatlock

Note: * These are suggested tension settings only.

- * Tension settings are effected by;
 - 1) Type and thickness of fabric
 - 2) Needle size
 - 3) Size, type and fiber content of thread

Correct Balance

- Set Each Tension Dial to Settings Shown at Right and Test Sew on a Sample of Your Fabric

How to Balance

- When the lower looper thread tension is too loose;
 - Turn the lower looper thread tension dial (yellow) toward a higher number.
 - Or, turn the needle thread tension dial (blue or green) toward a lower number.
- When the upper looper thread tension is too loose;
 - Turn the upper looper thread tension dial (orange) toward a higher number.
 - Or, turn the needle thread tension dial (blue or green) toward a lower number.
- When the needle thread tension is too loose;
 - Turn the needle thread tension dial (blue or green) toward a higher number.
 - Or, turn the upper looper thread tension dial (orange) toward a lower number.

NEEDLE POSITION	
SEAM WIDTH FINGER KNOB	S
STITCH LENGTH	2 ~ 4

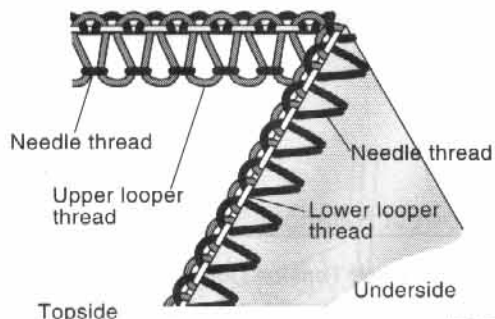

(505)

Fabric	Tension Dial			
	Blue	Green	Orange	Yellow
Light weight	0.5		4.5	5.0
Medium weight	0.5		5.0	6.0
Heavy weight	0.5		5.5	7.0

Fabric	Tension Dial			
	Blue	Green	Orange	Yellow
Light weight		0	5.0	5.0
Medium weight		0.5	5.5	5.5
Heavy weight		0.5	5.5	6.0

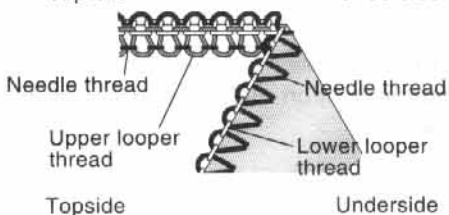
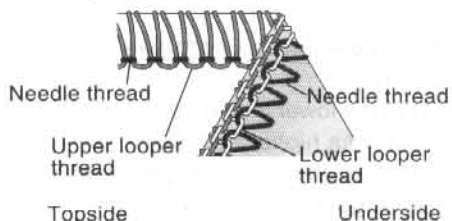
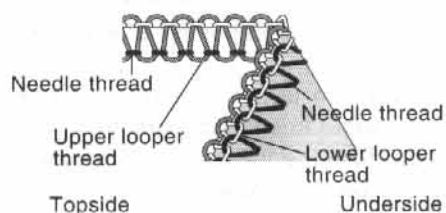



3) 3-thread Wrapped Edge Overlock

Note: * These are suggested tension settings only.

- * Tension settings are effected by;
 - 1) Type and thickness of fabric
 - 2) Needle size
 - 3) Size, type and fiber content of thread.

Correct Balance

- Set Each Tension Dial to Settings Shown at Right and Test Sew on a Sample of Your Fabric

NEEDLE POSITION		
SEAM WIDTH FINGER KNOB	S	
STITCH LENGTH	2 ~ 4	

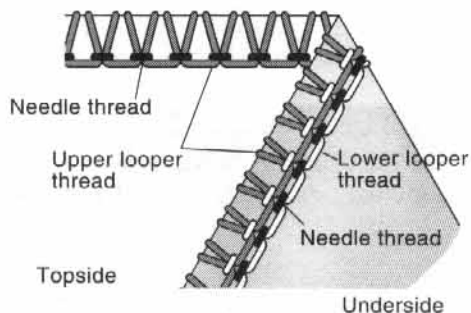

Fabric	Tension Dial			
	Blue	Green	Orange	Yellow
Light weight	2.0		0.5	6.0
Medium weight	3.0		0.5	7.0
Heavy weight	4.0		0.5	8.0

Fabric	Tension Dial			
	Blue	Green	Orange	Yellow
Light weight		2.0	0.5	6.0
Medium weight		3.0	0.5	7.0
Heavy weight		4.0	0.5	8.0

How to Balance

- When the upper looper thread tension is too loose;
 - Turn the upper looper thread tension dial (orange) toward a higher number
- When the lower looper thread tension is too loose;
 - Turn the lower looper thread tension dial (yellow) toward a higher number.
 - Or, turn the upper looper thread tension dial (orange) toward a lower number.
- When the needle thread tension is too loose;
 - Turn the needle thread tension dial (blue or green) toward a higher number.
 - Or, turn the upper looper thread tension dial (orange) toward a lower number.

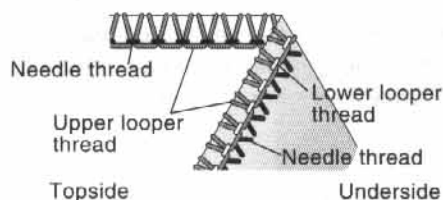
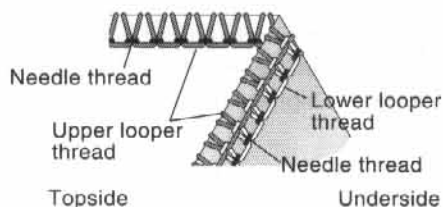
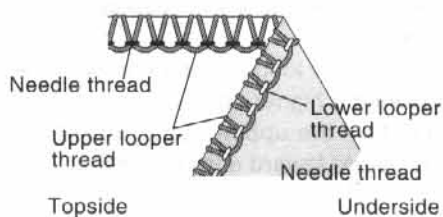

4) 4-thread Ultra Stretch Mock Safety Stitch

Note: * These are suggested tension settings only.

- * Tension settings are effected by;
 - 1) Type and thickness of fabric
 - 2) Needle size
 - 3) Size, type and fiber content of thread

Correct Balance

- Set Each Tension Dial to Settings Shown at Right and Test Sew on a Sample of Your Fabric

How to Balance

- When the upper looper thread lies on the underside of the fabric;
 - Turn the upper looper thread tension dial (orange) to a higher number.
 - Or, turn lower looper thread tension dial (yellow) to a lower number.
- When the lower looper thread appears on the top of the fabric;
 - Turn lower looper thread tension dial (yellow) toward a higher number
 - Or, turn the upper looper thread tension dial (orange) toward a lower number.
- When the left needle thread tension is too loose;
 - Turn the left needle thread tension dial (blue) toward a higher number.
- When the right needle thread tension is too loose;
 - Turn the right needle thread tension dial (green) toward a higher number.

NEEDLE POSITION	
SEAM WIDTH FINGER KNOB	S
STITCH LENGTH	2 ~ 4

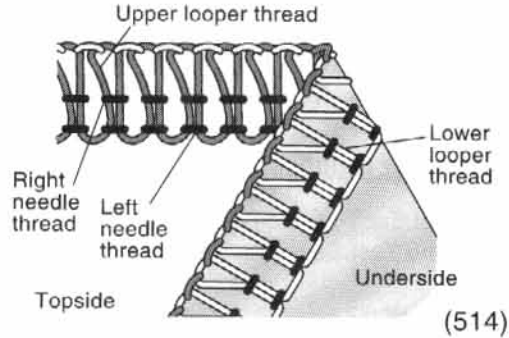

(514)

Fabric	Tension Dial			
	Blue	Green	Orange	Yellow
Light weight	2.0	1.5	2.0	2.0
Medium weight	2.5	2.0	2.5	2.0
Heavy weight	3.0	2.5	3.0	2.0

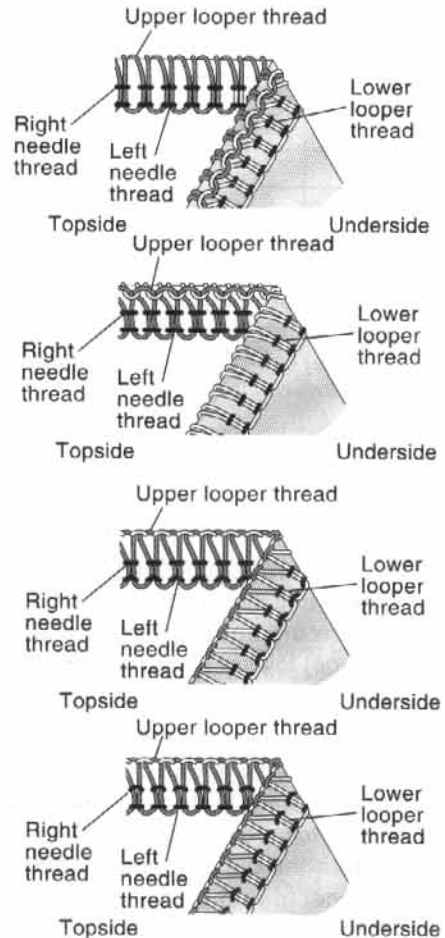

22. HOW TO SEW A ROLLED HEM

- This machine can sew four types of rolled hems.
- Rolled hemming is done by rolling and overedging the fabric edge.
- Light weight fabrics such as lawn, voile, organdy, crepe, etc. perform the best.
- Rolled hemming is not suited for heavy or stiff fabrics.

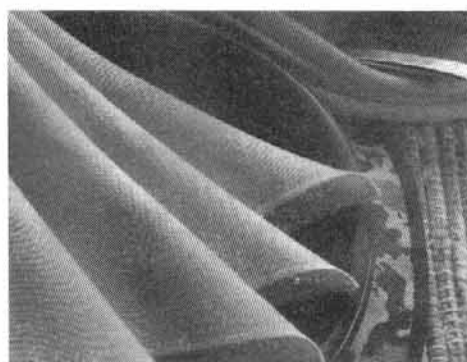

Machine Set Up

- Remove the left needle.
- Move seam width finger knob to setting R . (See page 27)
- Align left face of seam width finger support plate with R mark on throat plate by turning seam width finger knob, as required.
- Set stitch length dial to "F 2" and a fine seam will be sewn.
- Needle: Singer Needle #2022 size 80/11 or 90/14
- Thread: A variety of thread combinations can be used for rolled hemming.

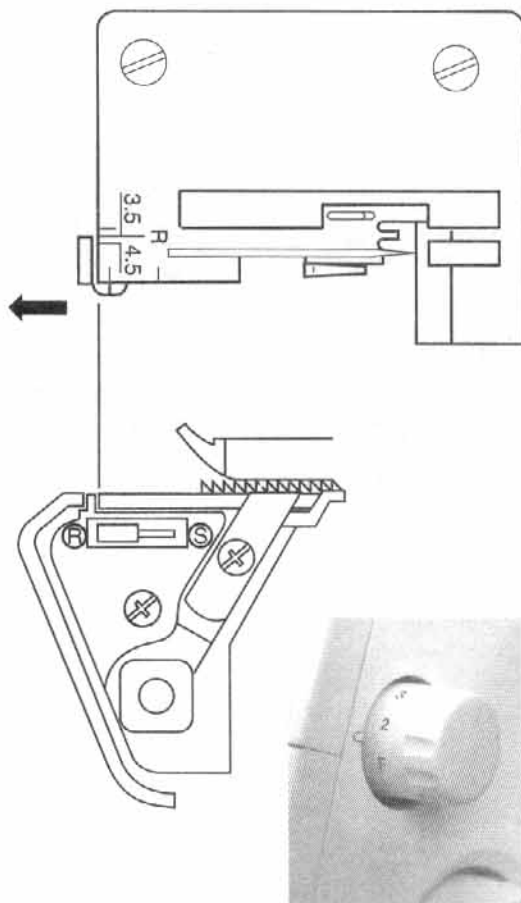

Note: For a beautiful rolled hem thread the upper looper with wooly nylon and the needle and lower looper with lightweight regular thread.

1) 3-thread Standard Rolled Hem Stitching

Correct Balance

- Set Each Tension Dial to Settings Shown at Right and Test Sew on a Sample of Your Fabric

NEEDLE POSITION	
SEAM WIDTH FINGER KNOB	R
STITCH LENGTH	F ~ 2

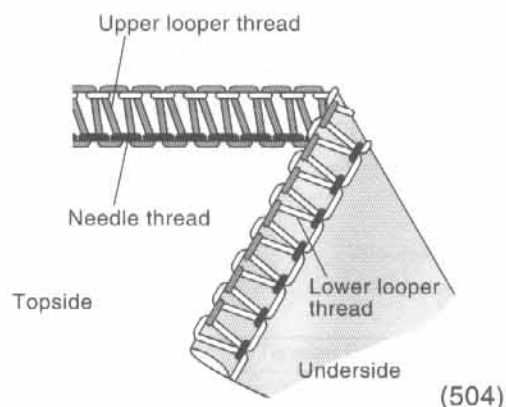

Upper Looper Thread	Tension Dial			
	Blue	Green	Orange	Yellow
Polyester		2.0	7.0	2.5
Woolly nylon		2.0	3.5	2.5

2) 3-thread Upper Looper Thread Wrapped Rolled Hem Stitching

Correct Balance

- Set Each Tension Dial to Settings Shown at Right and Test Sew on a Sample of Your Fabric

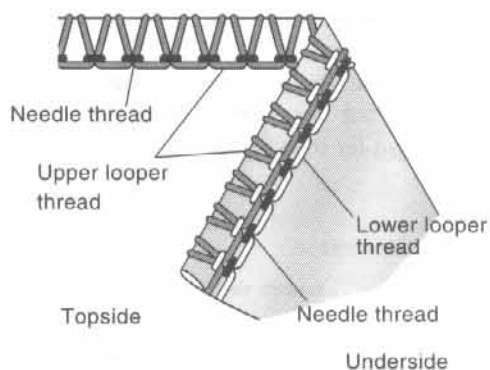

Upper Looper Thread	Tension Dial			
	Blue	Green	Orange	Yellow
Polyester		2.0	5.0	7.0
Woolly nylon		2.0	2.0	5.0

Additional Information About Rolled Hemming

- Hold the thread chain when you begin sewing to keep it from curling into the seam.
- Place a slight tension on the material in the sewing direction and a finer seam finish can be obtained.
- The minimum overedge stitch width that can be obtained for rolled hemming is approximately 1.5mm (1/16 inch) since the cutting width cannot be set below 3.5mm (9/64 inch).

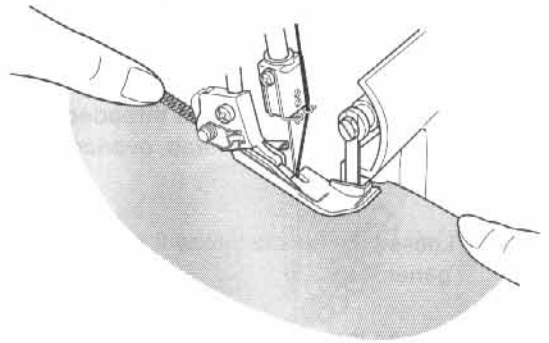
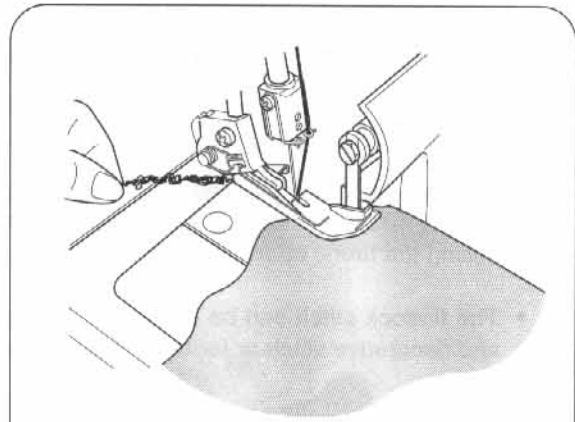

To Secure the Rolled Hem Thread Chain

- Apply a small drop of liquid seam sealant to the end of the seam. Allow to dry, then cut the chain close to the stitches.

Note: Test the liquid seam sealant for color fastness before use.

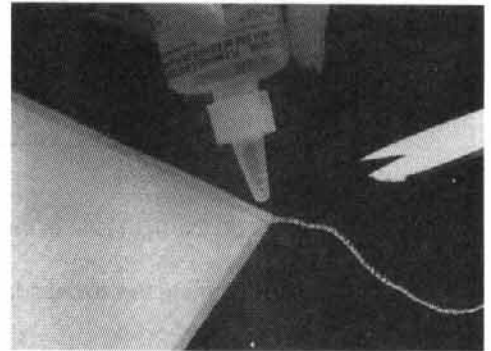

23. STITCH VARIATIONS AND SEWING TECHNIQUES

How to Sew a Flatlock Decorative Seam

- A flatlock stitch is achieved by adjusting the tension of the 3-thread overlock stitch, sewing the seam and pulling the fabric apart to flatten the seam.
- The flatlock stitch can be used as a construction and decorative stitch or for ornamentation only.

(1) Machine Set Up

- Remove the left or right needle.
- Begin with the machine threaded and tension balanced for the 3-thread overlock stitch (page 29).
- Loosen the needle thread tension (green or blue) generously.
- Loosen the upper looper thread tension (orange) slightly.
- Tighten the lower looper thread tension (yellow) generously.

(2) Flatlocking a Seam

- Place the fabric wrong sides together to sew a decorative stitch on the right side of the garment.
- Sew the seam, trimming the excess fabric.
- The needle thread (green or blue) will form a V on the underside of the fabric.
- The lower looper thread will pull into a straight line at the fabric edge.

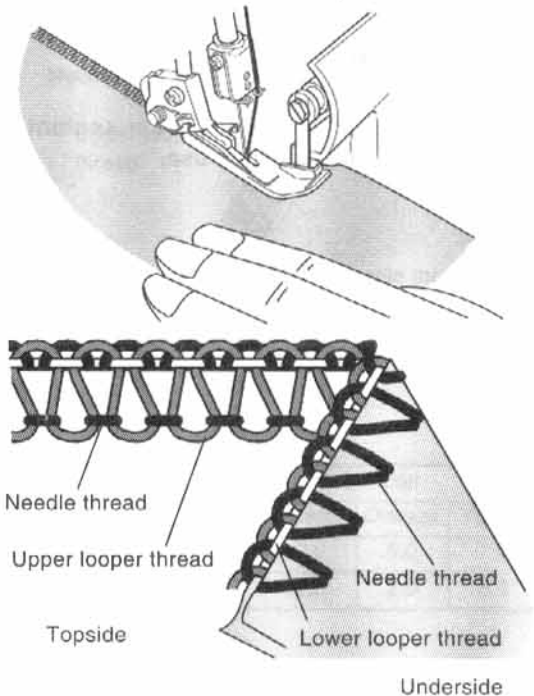
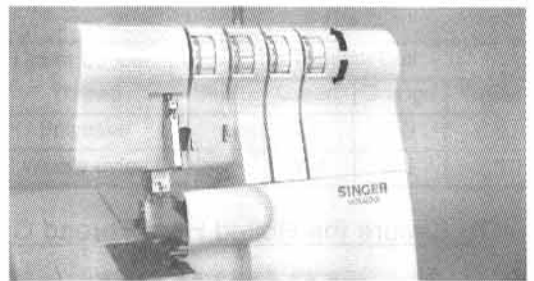
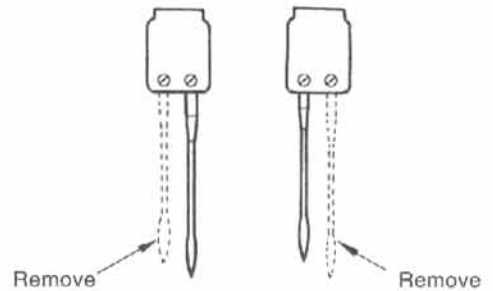
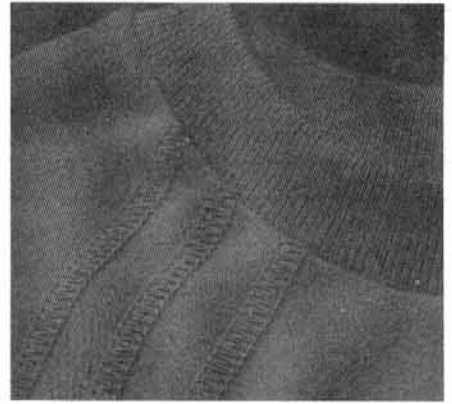

- Pull on opposite sides of the seam to pull the stitches flat.

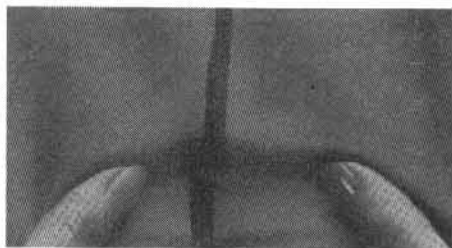

(3) Decorative Flatlocking

- Place the movable upper knife in the nonworking position (page 25). The fabric is not trimmed on this stitch.

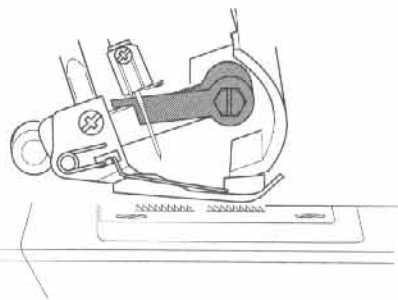

- Fold fabric wrong sides together.
- Position the fabric so the seam is sewn with part of the stitch extending off the fabric.

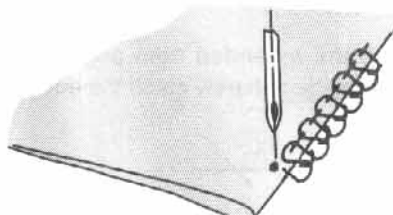

- Pull on opposite sides of the stitch to flatten.

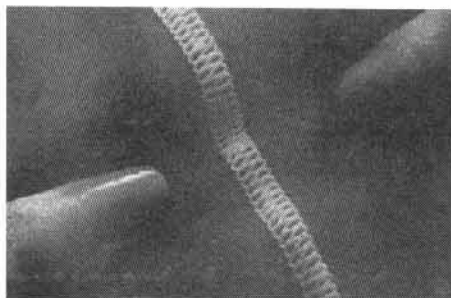

(4) Additional Information About Flatlocking

- The tensions must be correctly adjusted for the fabric to pull flat.
- The upper looper thread is the prominent thread in the flatlock stitch. Place a decorative thread in the upper looper and inconspicuous threads in the lower looper and needle.
- For a ladder stitch, sew seam with right sides together. The needle thread will be the prominent thread that creates the ladder (A).

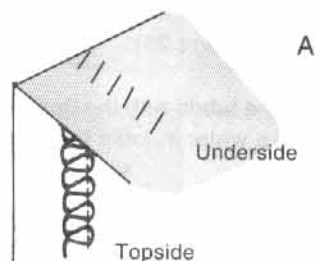

How to Sew an Overlock Blind Hem

- The excess fabric is trimmed and the hem is sewn and the raw edges are overlocked in one operation.
 - The overlock blind hem is best suited for sewing knit wear. It provides a durable finish that is almost invisible.
 - Remove the left needle and adjust machine for a narrow 3-thread overlock stitch.
- Note: The three-thread flatlock stitch can also be used.
- Set the stitch length dial at 4.
 - Fold the hem to the wrong side of the fabric, then back to the right side with 6mm (1/4") beyond the fold.
 - Stitch on the extended hem edge, allowing the machine needle to barely catch the edge of the fold.

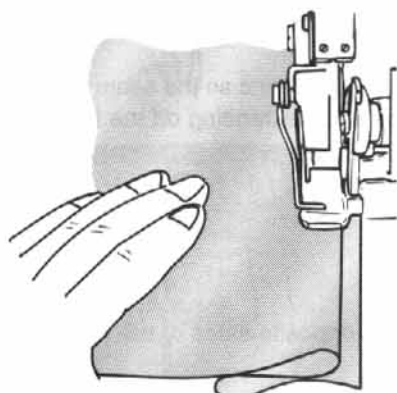
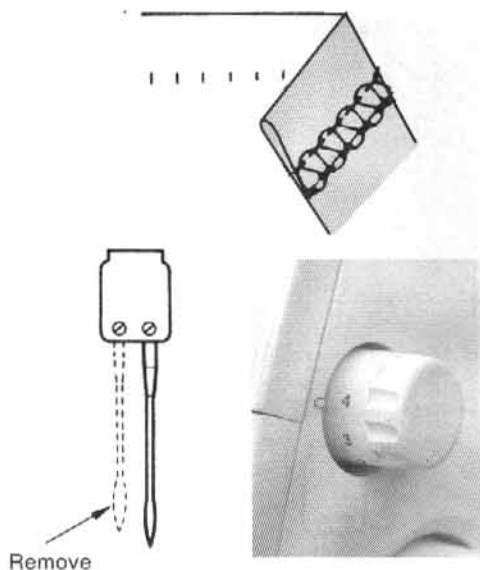

How to Sew Pin Tucks

- Sew decorative pin tucks on the fabric before cutting out the garment.
 - Remove the left needle and adjust machine for a narrow 3-thread overlock stitch.
- Note: The rolled hem stitch can also be used for this technique.
- Place the movable upper knife in the nonworking position (page 25).
 - Mark the fabric with the desired number of pin tucks using a water soluble fabric marker.

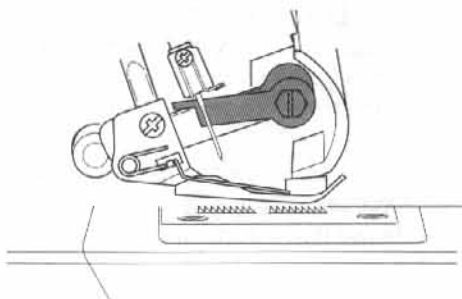
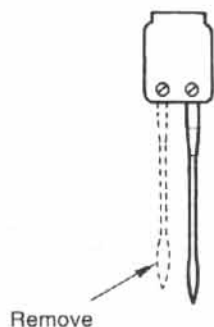

- Fold the fabric with the wrong sides together and sew.

- Press the pin tucks in the same direction.

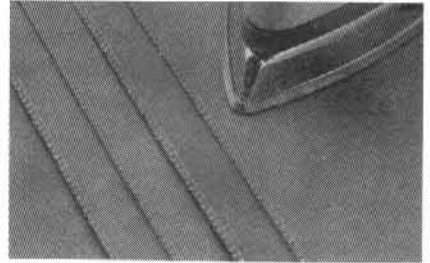
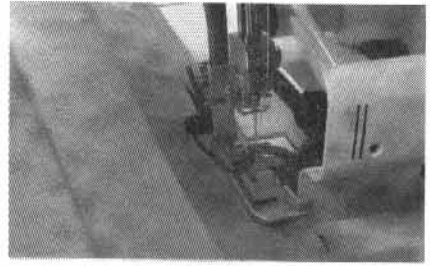

Turning Square Corners

(1) Outside Corner

- Cut out approximately 2 cm (51/64 inch) from the corner, in line with the overedge seam edge.
- Sew one stitch beyond point (A) and stop.
- Raise needle and presser foot.
- Pull the fabric to the rear of the machine just enough to release the thread caught on the finger of the throat plate.

Note: Presser foot has been removed to show detail.

- Turn the fabric and lower the presser foot so that the knife is positioned in line with the cut edge.
- Pull slack threads up, then start to sew.

(2) Inside Corner

- Cut fabric at seam edge.

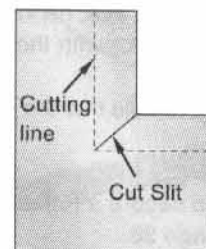
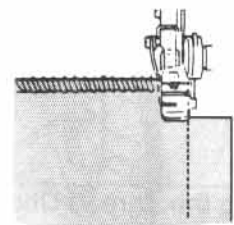
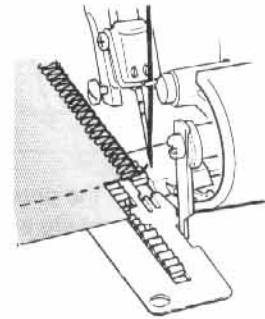
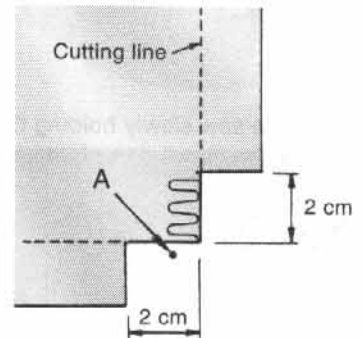

- Place the movable upper knife in nonworking position (page 25).

- Stitch on cut edge of fabric.
- Stop sewing before you reach the corner and fold the fabric to the left to straighten the corner.

- Continue to sew slowly holding the fabric edge in a straight line moving the fold as you sew.

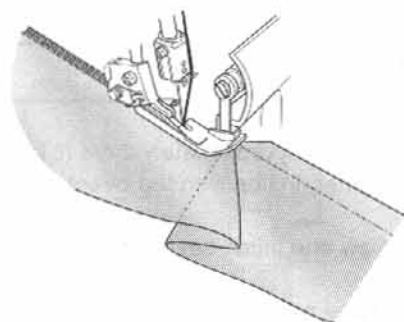
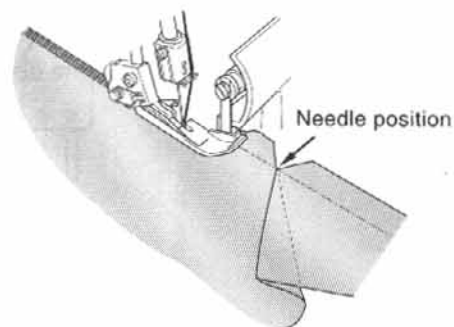

Pin Placement

- Insert pins to the left of the presser foot. The pins will be easy to remove and are away from the cutting action of the knives.



Caution:
Sewing over pins will damage and/or destroy the cutting edge of the knives.

Securing the Thread Chain

- Thread a large eye, hand sewing needle (such as a tapestry needle) with the thread chain.
- Insert the needle into the end of the seam to secure thread.

Note: To secure a rolled hem thread chain, see page 35.

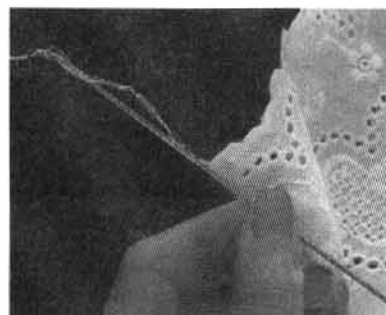

How to Reinforce a Seam

- Inserting twill tape while overedge sewing will stabilize the seam.
 - Insert the tape through the hole in the front of the foot.
 - Position the tape under the foot to the back of the machine and sew the garment seam.
-
- The tape is attached as the seam is sewn.

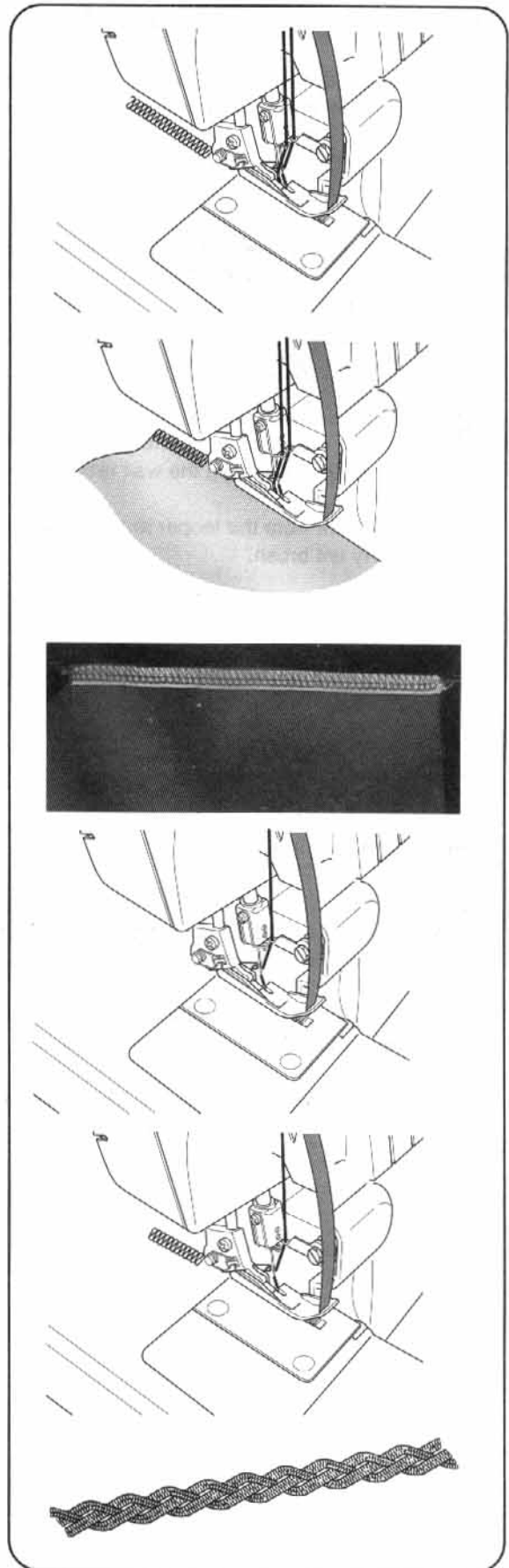

Braiding by Chaining Off

- Place the movable upper knife in nonworking position.
- Insert filler cord such as yarn or twill tape through the hole in the front of the foot.
- Position the filler cord under the foot and chain off the desired length.
- Chained off braids can be used individually or woven into 3 or 4 ply braids.

24. MACHINE MAINTENANCE

An overlock requires more maintenance than a conventional machine mainly due to two reasons.

- 1) A lot of lint is produced due to the cutting action of the knives.
- 2) An overlock runs at a very high speed and needs to be oiled frequently to lubricate the internal working parts.

Cleaning the Machine



Danger:

Before cleaning your machine, disconnect power line plug from the wall receptacle.

- Clean the lint from the looper and knife area often with a dry lint brush.

Note: Lint brush is an optional part.



Oiling the Machine



Danger:

Before lubricating your machine, disconnect power line plug from the wall receptacle.

- The oiling points shown in the diagram, should be oiled periodically.

Note: Use sewing machine oil. Do not use any other oil or damage could result.

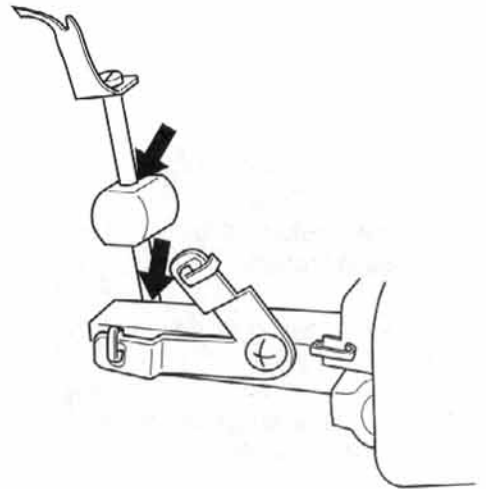

How to Replace the Stationary Knife



Danger:

Before replacing the stationary knife, disconnect power line plug from the wall receptacle.

- The stationary knife should be changed when it becomes dull.
- The stationary knife can be replaced according to the directions provided, however if there are any difficulties experienced, consult your Singer representative to make the adjustments.
- Be sure that the power line plug is disconnected from the electric source.
- Open the looper cover and set the movable upper knife 1 in the nonworking position (page 25).
- Loosen the stationary knife set screw 2 and remove the stationary knife 3.
- Place a new stationary knife in the groove of the stationary knife holder.
- Tighten stationary knife set screw 2.
- Return the movable upper knife 1 to its working position.

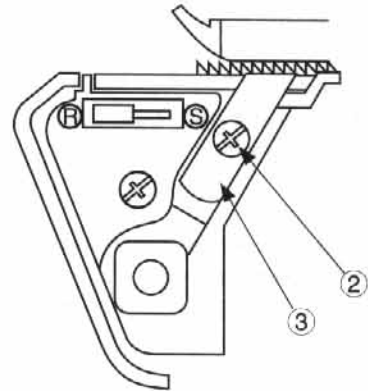
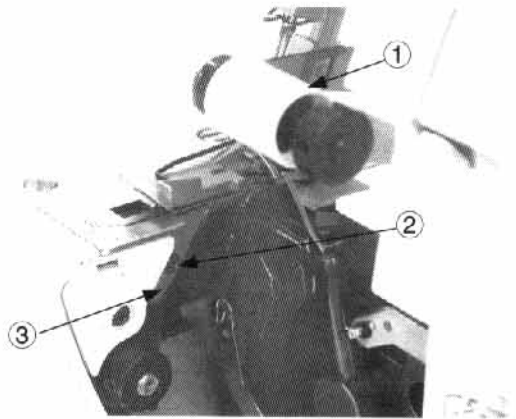

How to Exchange Light Bulb



Danger:
Always unplug before relamping

- Light bulb is available at your Singer shop. Take old bulb to the Singer shop and ask for same bulb.
- If voltage indicated on the electrical rating plate of your machine is 110 ~ 127V, ask for light bulb conforming to following specification.
 - Bayonet type: 110 ~ 127V, 15W
 - . Glass shape: T-20
 - . Lamp cap: BA15D/19
 - . Overall length: 48 ~ 58mm

- Remove light cover screw and while pushing the cover lightly to the rear, swing cover to the left and remove from machine as shown in the illustration. Turn bulb to the left to remove. To replace the bulb, push bulb into the socket and turn to the right.



Caution:
Be sure the light bulb has cooled off before changing with a new one.



Warning:
Replace the light cover first before connecting the power line plug.

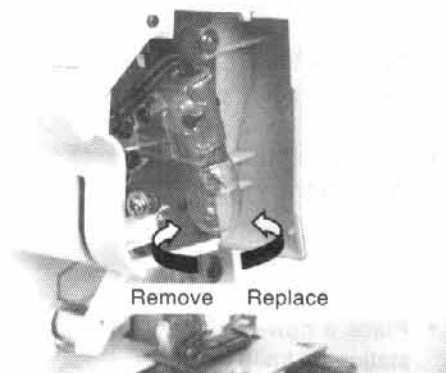
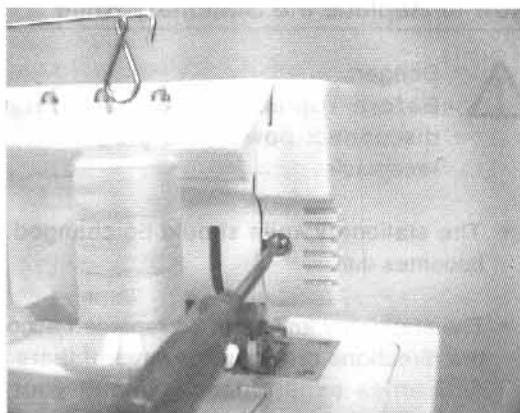

- If voltage indicated on the electrical rating plate of your machine is 200 ~ 240V, ask for light bulb conforming to following specification.

- Edison type (screw type): 200 ~ 240V, 15W
- . Glass shape: T-22
- . Lamp cap: E14
- . Overall length: 56mm

- Remove light cover screw and while pushing the cover lightly to the rear, swing cover to the left and remove from machine as shown in the illustration. Turn bulb to the left to remove. To replace, screw bulb into socket turning it to the right.

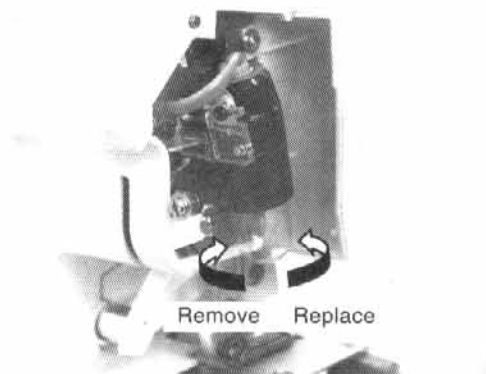

25. TROUBLESHOOTING CHART

Problem	Solution	Page
Fabric does not feed well	- Lengthen stitch length.	21
	- Increase presser foot pressure for heavy weight fabric.	22
	- Decrease presser foot pressure for light weight fabric.	22
Needle breaks	- Insert needle correctly.	11
	- Do not pull fabric while sewing.	28
	- Tighten needle set screw.	11
	- Use a larger needle on heavy fabrics.	7
Thread breaks	- Check threading	12 ~ 19
	- Check for tangled or caught thread	20
	- Insert needle correctly	11
	- Insert new needle, current needle may be bent or have a blunt point.	7
	- Use a high quality thread.	46
Stitches skip	- Loosen thread tension.	29~ 34
	- Insert new needle, current needle may be bent or have a blunt point.	7
	- Tighten needle set screw.	11
	- Insert needle correctly.	11
	- Change type or size of needle.	7
	- Check threading.	12 ~ 19
	- Increase presser foot pressure.	22
- Use a high quality thread.	46	
Irregular stitches	- Balance thread tension.	29~ 34
	- Check for tangled or caught thread.	20
	- Check threading.	12 ~ 19
Fabric puckers	- Loosen thread tension.	29~ 34
	- Check for tangled or caught thread	20
	- Use high quality light weight thread.	46
	- Shorten stitch length.	21
	- Decrease presser foot pressure for light weight fabrics.	22
Irregular trimming	- Check alignment of knives.	43
	- Replace one or both knives.	43
Fabric jams	- Close looper cover before sewing.	9
	- Check for tangled or caught thread.	20
	- Compress thick layers of fabric with conventional machine before sewing with overlock.	
Machine does not operate	- Connect machine to power source.	9

26. RELATIONSHIP BETWEEN CLOTH, THREAD AND NEEDLE

Type of Fabric	Type of Thread	Needle Singer Cat. No. 2022
Light Weight Lawn, Organdy, Voil, Crepe, etc.	Cotton: #100 Silk: #100 Spun: #80 - #90 Tetron: #80 - #100	#11
Medium Weight Muslin, Sheersucker, Satin, Gabardine, Broadcloth, etc.	Cotton: #60 - #80 Silk: #50 Spun: #60 - #80 Tetron: #60 - #80	#11, #14
Heavy Weight Oxford, Denim, Tweed, Corduroy, Serge	Cotton: #40 - #60 Silk: #40 - #60 Spun: #60 - #80 Tetron: #50 - #80	#14
Knit Tricot	Spun: #80 - #90 Tetron: #60 - #80	#11
Jersey	Spun: #60 - #80 Tetron: #60 - #80 Cotton: #60 - #80	#11, #14
Wool (woven, knit)	Spun: #60 - #80 Tetron: #50 - #60 Woolly nylon Woolly tetron	#11, #14

Singer needle, Cat. No. 2022 is furnished with the machine however.

It is recommended that you select your needle in accordance with the material you are sewing.

27. SPECIFICATION

Item	Specification	
Sewing speed Stitch length (feed amount) Differential feed ratio Overedge stitch width Needle bar stroke Presser foot rise Needle	1,300 spm maximum 1 ~ 4mm (standard: rolled hemming F - 2, ordinary overedge 3.0) 1:0.7 ~ 1:2 (with differential feed machine) Rolled hemming 1.5mm, ordinary overedge 3.0 ~ 6.7 mm (standard 3.5mm) 27mm 4.5mm Rolled hemming: Singer Cat. No. 2022 #11 Ordinary overedge: Singer Cat. No. 2022 #11, #14	
Model Number of threads Machine dimensions (mm) Width Depth Height Weight (Kg)	14SH644 3, 4 329 270 265 6.0	14SH654 3, 4 329 270 265 6.2