

ECOVACS

Robot Vacuum Cleaner

Deebot

D58 User Guide

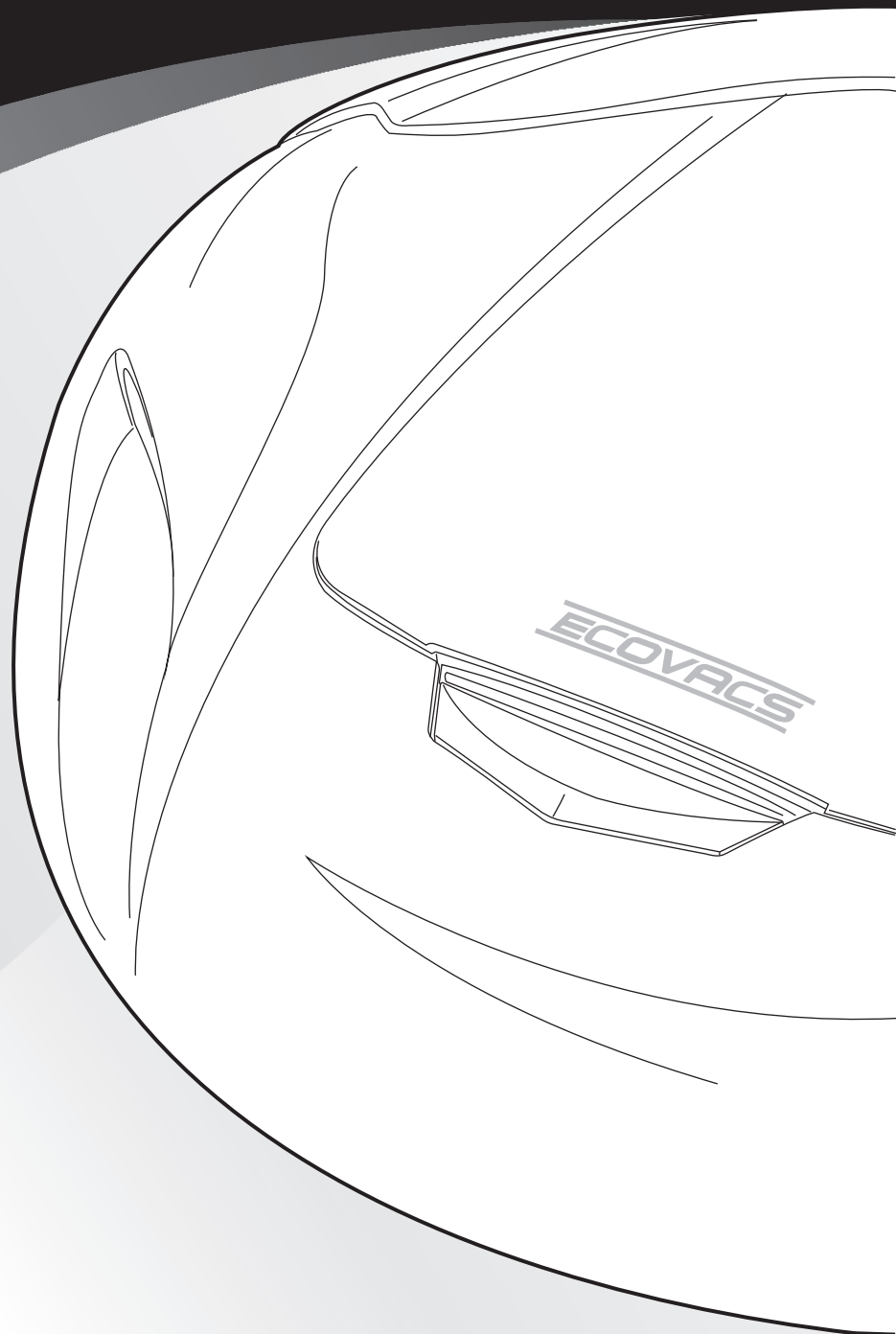

Thanks for purchasing ECOVACS Deebot patented Robot Vacuum Cleaner products. Hope you can enjoy it !
Thanks again for your choice!

Thank you for your choice!

Content

1. Safety Instruction3	
User Guide.....3	
Power Supply for the Product.....3	
The Spectrum of Product Use.....4	
Notes before Cleaning.....5	
Child Safety.....5	
Battery Replacement and Disposal.....6	
Resource Utilization.....6	
When Product is in Failure.....6	
2. Content in the Original Package and Technical Parameter7	
3. Name of Parts9	
The Host9	
LCD and Control Panel.....10	
4. Battery Charging10	
Assembly Charging Block.....10	
Charging.....11	
5. Power On/Pause/Power Off12	
Power On.....12	
Pause.....12	
Power Off.....12	
6. Mode Selection13	
Automatic Cleaning Mode.....13	
Border Cleaning Mode.....14	
Fixed Point Cleaning Mode.....14	
Intensive Cleaning Mode.....14	
Go Back Charging Mode.....14	
7. Automatic Charging15	
8. Appointment Timing15	
Set Appointment Time.....15	
Set Current Time.....16	
	Set Frequency and Cancel Timing.....17
	9. Remote Control17
	Battery Placement.....17
	Use of Remote Control.....18
	10.Virtual Wall18
	Battery Placement.....18
	Use of Virtual Wall.....19
	11. Border Tape20
	12. Day-to-Day Storage21
	13. Maintenance21
	The Host Cleaning.....21
	Dust Box Cleaning.....21
	Cotton Filter and Filters Cleaing.....22
	Sponge Filter Replacement.....23
	Main Brush Cleaning.....23
	Side Brush Cleaning.....24
	Side Brush Replacement.....24
	Driving Wheel Cleaning.....24
	Up-Ground Height Sensor Cleaning.....24
	Dust Sensor Cleaning.....25
	14. Alarming25
	15. Common Failure26
	16. Other Problems27

1. Safety Instruction



Warning : Where there is a drop off in the cleaning area due to a step or stairs and they are not carpeted, you should operate the unit to see that the unit can detect the step without falling over the edge. It may become necessary to place a physical barrier at the edge to keep the unit from falling over the drop but make sure the physical barrier is high enough so that you or a family member will not trip on the barrier and cause themselves injury.

⚠ Note:

- ▶ Do not open the equipment. The components inside the robot host are beyond repair by user himself, such as remote control and virtual wall.
- ▶ This product is only for domestic use, not suitable for industry or outdoor surroundings.
- ▶ Please do not press LCD.

The User Guide

Please conform to the basic safety precautions as follows:

- Read the content in this user guide carefully and install the robot according to the detailed instructions.
- Safekeeping this guide. If you transfer this machine to another person, please make sure attach this booklet.
- Any inconsistent operation with this guide would probably cause serious damage to both human being and the machine itself.

Power Supply for the Product

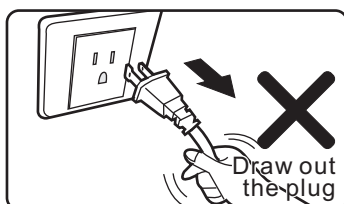
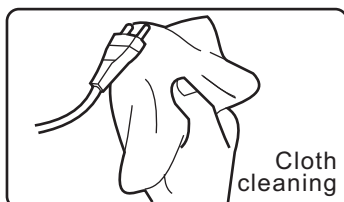
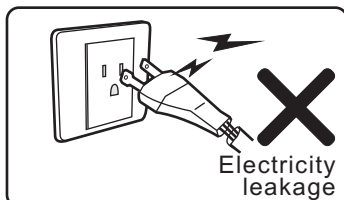
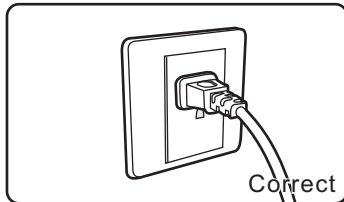

- The power supply is from a Ni-MH chargeable battery inside the host of the robot and it is specially assigned with a charging block to do recyclable charge.
- Please double check the marked supply voltage on the charging block and make sure it is applied according to the instructions.
- Do not use the damaged power cord or plug, while contact our after-sales service or find our authorized supplier to maintain.
- As the charging block is heavy, please never drag the block via pulling it's power cord.
- Remember never to twist and swing or screw the power cord excessively, neither to block it when close the door. We should not put heavy things on it as well.
- Do not let power cord touch hot or sharp surfaces.
- Do not draw out the plug by pulling the cord.
- Keep wet hands away from the plug or machine.
- Pull the plug out of socket when you no longer use the charging block for some time.
- Use dry cloth to wipe the dust on the plug frequently.

The Spectrum of the Product Use

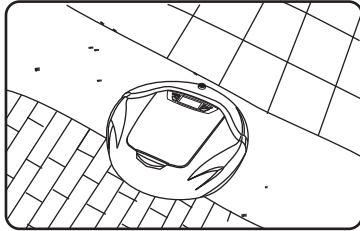

- This robot is applicable to domestic sweeping, including wooden floor, rubber floor, ceramic tile, linoleum and medium or short-haired carpet however, it is inapplicable to long-haired carpet.

- It can not be used for the floor as below:

----- Have water on the surface (including flammable liquids), such as wet floor.

----- Inside toilet, shower room or other humid situation.

----- Staircase

----- The room with furnace or flame

- The following objects are definitely forbidden:

----- Not extinguished soot, burning cigarette butts or match, because these objects would cause fire.

----- Sharp objects like glass debris, pin, paper clip, stones, gypsum, and large piece of paper. These things may block the machine.

----- Water or other kind of liquid, especially detergent, kerosene, petrol, paint, alcohol, perfume, as well as carpet or floor cleaning solution. It would make the interior of the machine wet, so that may cause short-circuit.

----- The toner of laser printer and copier which may bring fire and explosion.

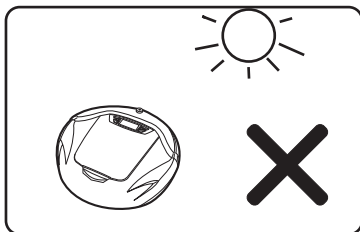
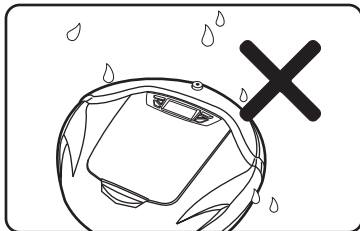
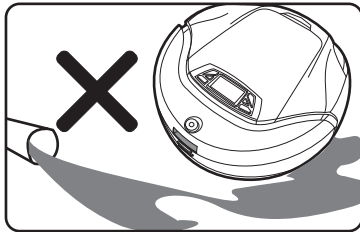
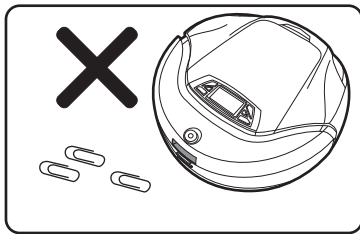

-
- Please keep the machine away from hot source such as oven and fireplace, because the hot can distort the crust.

- Do not use the machine in the surroundings with any explosion risk. For example, at gas station, oil depot, chemical plant and so on.

- Never use the machine outdoors. As rain or solid dust may get inside it and cause damage.

- Do not repair or change any performance by yourself.

- Do not throw or bend the machine.

- Do not dampen it, or else the short-circuit would cause fire or electric shock accident.

- Take care of routine maintenance and keep it in a clean place.

- Do not expose the machine in the extreme hot or cold surroundings. This product is not allowed to long-time kept in the temperature below zero or over thirty degree.

- Do not keep the machine in the liquid or expose it to high humidity.

- Do not place the machine close to burning cigarette or fire.

Notes before Cleaning

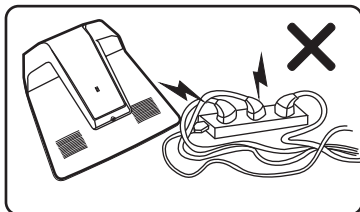
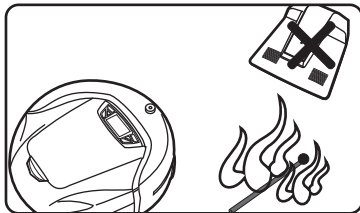
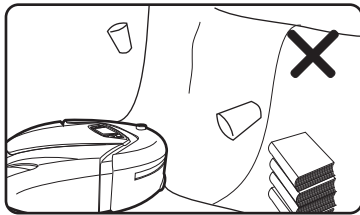
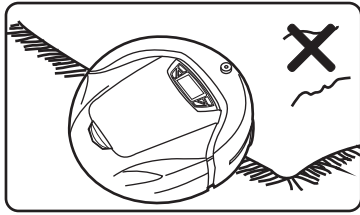

- Take extra care of the robot when the first it works. Please remove the obstacles when it is beyond the robot. Try to avoid the situation that the robot stops working.
- Make precautions to solve the problem which may make the cleaning in trouble, such as:
 - Keep the easily knock over objects in a safe place.
 - Permian the edge of the carpet.
 - The hanging table cloth and curtain should not touch the ground.
 - The flammable object should be cut from the fire source.
 - Sort out the tangled power cord on the floor.
- Check whether the main brush is correctly fixed inside the robot before cleaning.
- Examine if the dust box is empty and insure it is fixed before it works.
- See if up-ground height sensor and dust sensor are wiped clean.

Child Safety



- Child, physically or mentally disabled and inexperienced are not allowed to use it, unless their safety supervisor is there to give instruction.



- Take good care of the product and keep it beyond child and people who can not judge danger nearby. Extra attention should be paid when it starts working.
- You should get the person inside the room know that the machine is working, in order to avoid man-made damage like tripping.
- Do not take robot as toy. Carefully attention should be paid when child or pet is around.
- The plastic package may bring danger of asphyxia and is supposed to keep away from child.

Battery Replacement and Disposal

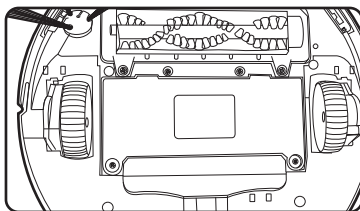

- You need to contact our after-sales when you want to change the battery. It will cause explosion if you use replacement battery of wrong model.
- There is potential danger if you use other producer's battery and charging block. The damage cause hence is not within the warranty.
- Please dispose the spent battery properly, because there is hazardous substance which may pollute the environment.
- Conform with local environmental legislation and dispose it at the recovery site.

Resource Utilization



- Do not take the package material as domestic garbage and discard it freely.
- Please deliver the package material to proper recovery site for recycle.

When Product is in Failure

- Do not repair or disassemble the machine when there is damage of the power cord or failure of the host.
- Contact our after-sales service or our designate maintenance organization for professional repair.

2.Content

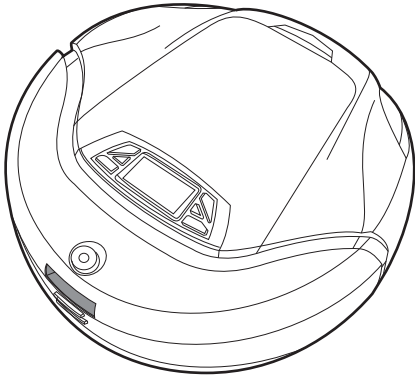

Host

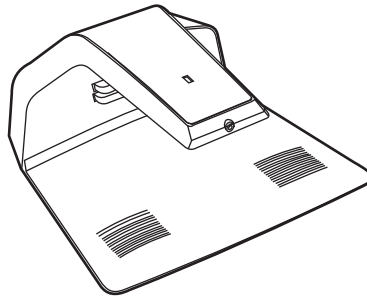

Charging block

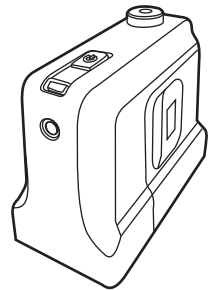

Virtual wall

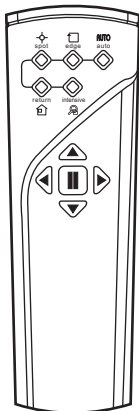

Remote control

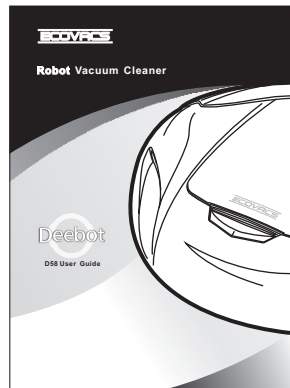

User guide

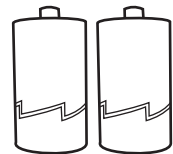

Battery for virtual wall

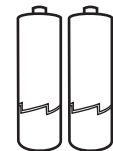

Battery for remote control

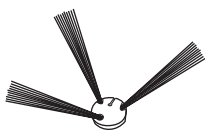

Side brush

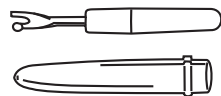

Roll brush clean-up gadget



Border Tape



Magnetic adding tool

technique parameter

The host		The charging block	
Working voltage	DC14.4V	In-put voltage	AC220-240V
Rated power	30W	rated out-put voltage	DC17.5V
Speed	0.25meter/second	rated frequency	50Hz
Capacity of dust box	0.7L	rated power	30W
Noise	≤62dB	rated out-put currency	0.8A
Charging duration	About 3 hours	Virtual wall	
Duration upon full battery 60 minutes	About 60 minutes	In-put voltage	DC3V
Max Coverage upon full battery	120-150M ²	Remote control	
Size	330×330×100mm	In-put voltage	DC3V
Net weight	2.8Kg	Remote control distance	≤5meters

3. Name of parts

host

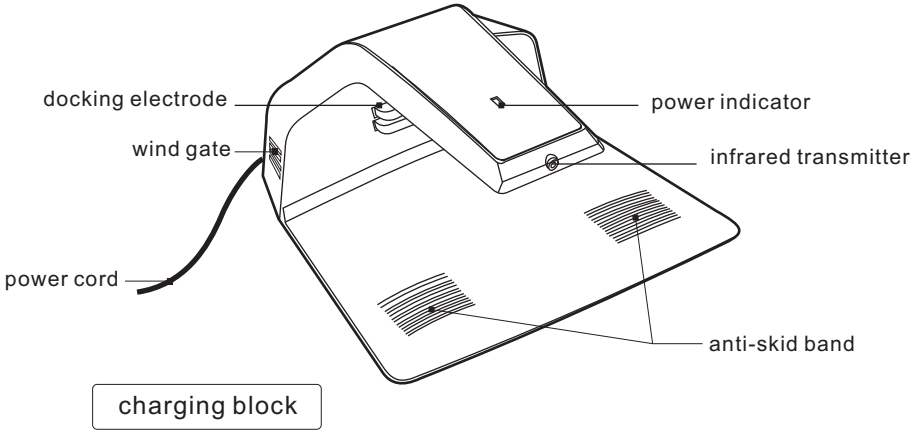
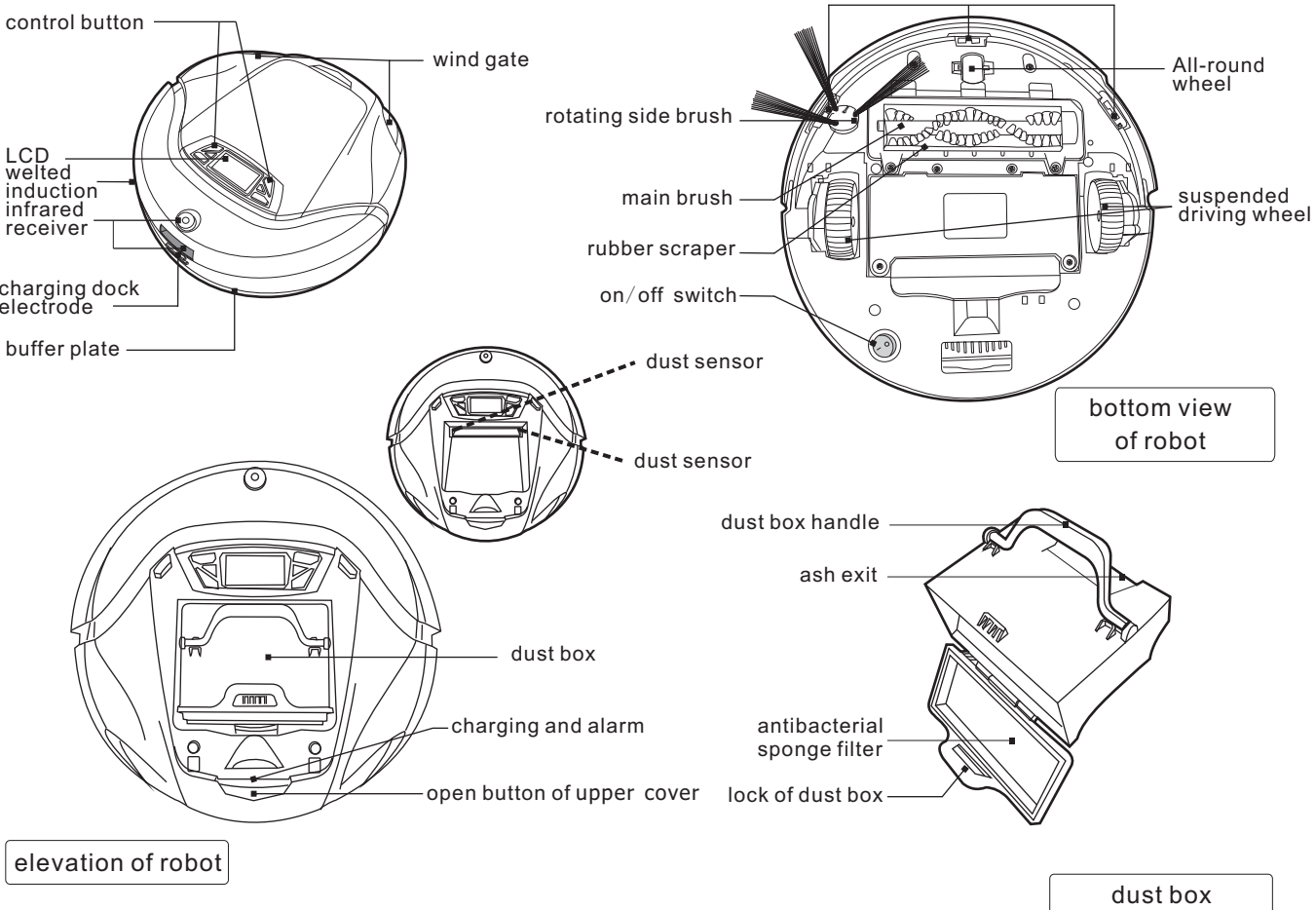

LCD and Control Panel

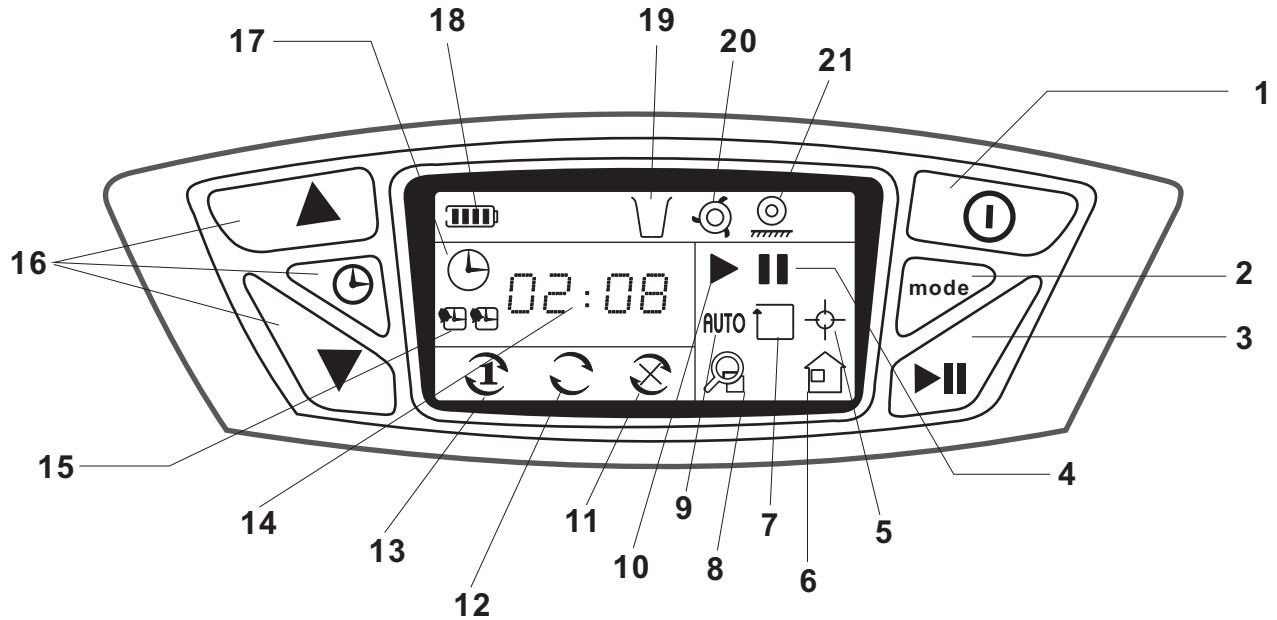

- | | | | |
|------------------------------|------------------------------|---|-----------------------------------|
| 1. Power | 8. Intensive cleaning mode | 15. Appointment time setting | 20. Tip for trapped |
| 2. Model selection | 9. Automatic cleaning mode | 16. Time adjust button | 21. Tip for driving wheel suspend |
| 3. On/Pause | 10. Operation status | 17. Current time setting status | |
| 4. Pause status | 11. Cancel timing cleaning | 18. Battery display | |
| 5. Fixed point cleaning mode | 12. Keep timing cleaning | 19. Tip for lacking and cleaning dust box | |
| 6. Go back charging mode | 13. One-time timing cleaning | | |
| 7. Border cleaning mode | 14. Time display | | |

4. Robot Charging

Placement of charging dock

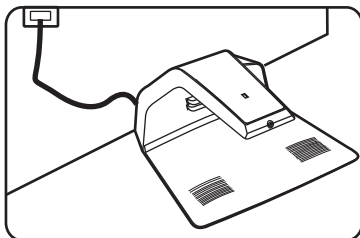

Put the block at an even place and make the base perpendicular to the ground. Meanwhile, take a look at the marked electricity voltage to make sure the product is used under instruction.

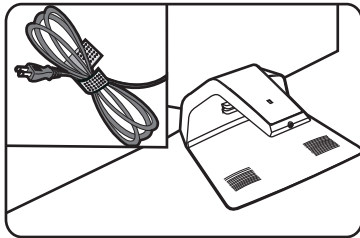

Tangle the power cord on the pothook and do not scatter it besides the block or hold it under the base, in case that robot would get impeded when it turns back.

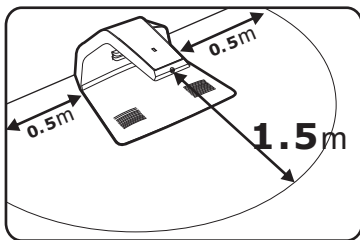

There should not be any object at least 1.5 meter in front of the charging block. Besides, anything with strong reflector is not supposed to stay ahead of the infrared receiver. For example, ground glass, smooth ceramic vase and so on. Other wise, the machine shall not detect the charging block.

Note:

Please do not put the charging block near to the staircase to avoid accidental cases.

Robot Charging

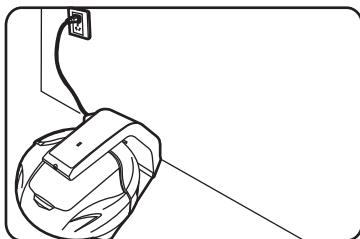

- You need to charge the robot the first time it works. Put away the full-charged battery for use to ensure it's performance.
- Charging duration should be around 3 hours.
- Charging is only allowed under the temperature between 0 and 45 degree and extreme hot or cold would extend charging duration or even cause damage to the battery.

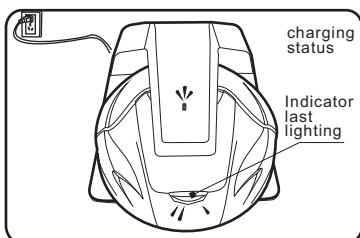
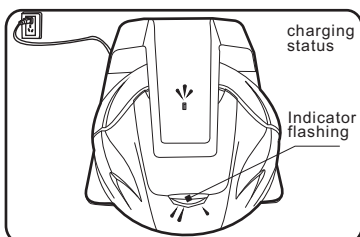

Tips:

- ▶ To make sure the robot is working in saturation, we suggest you to keep charging connected even though the charging indicator lasts lighting. At the same time, the system would transfer to weak current for supplementary charging.
- ▶ According to actual ground situation, robot can keep working for around 60 minutes after being charged full.
- ▶ The capacity of battery, which is not used for long time, will get certain decrease, so the use time can be shorten accordingly.

5. Power On/Pause/Power off

Get power supply and power on

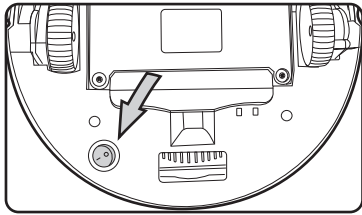

- Turn on the power switch on the bottom firstly.

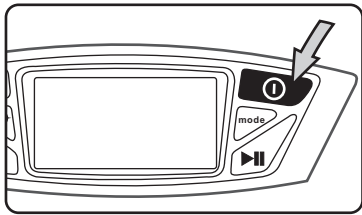

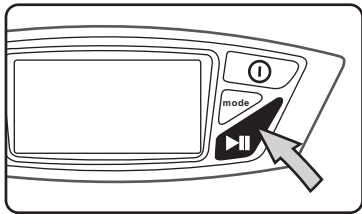

- Press the  key on host and get power supply. There would be a short music tip and at the same time LCD lights for roughly 2 second and goes off.

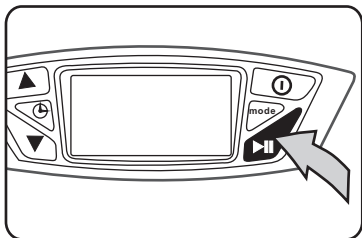

- Then press  key to start robot.

Pause





- Press  key, it can pause the operation of robot and keep it stay where it is.

Tips:

- ▶ On the status of pause, you can reset the cleaning mode, then press  key again, it will go back to work.
- ▶ Another way to pause is that, when the robot is working you can press any key on the host or lift it.

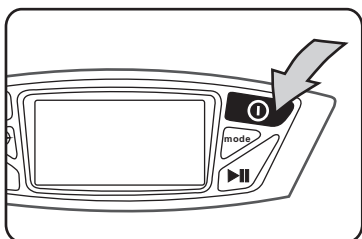
Power off



- Press  key, power is off and the robot stops running.

Tips:

- ▶ If you want the robot to stop running, you can press  key under pause status, then power is off.
- ▶ Put the robot back to the charging block after it stops working for fear that others would trip or step on.

6. Mode Selection

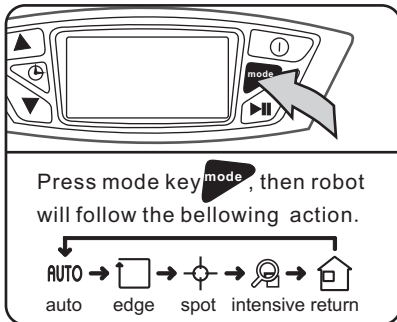

Tips:

- ▶ Put the robot on the charging block and keep it charging after finishing house cleaning.
- ▶ Do not keep the robot on pause status for long time, because under pause, the full charged battery can only last for around 20 hours. We suggest you to turn it off when you do not want it to work.

Status instruction:

The meaning of often used three status here and hence mentioned is as follows:

Working status: robot is doing cleaning work

Standby status:

Case one: press **power** key and do not operate.

Case two: press **pause** or any other key on host when robot is running, it pauses.

Case three: lift the robot.

Power off status: it is not power on, or under working status.

Press **power** key under standby mode, it is power off.

AUTO Automatic Cleaning Mode

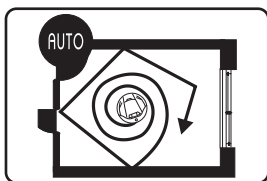
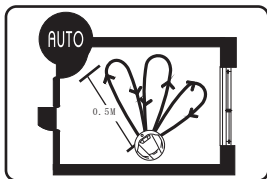
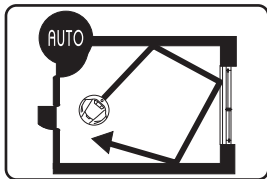

Route description: first going straight ahead, it turns when it meets obstacle. This status will last until the robot detects that it shall run of battery and it would turn to back charging status.

If robot detects that there is plenty of dust on the staring point, it will take the route as fan-shaped or spiral route.

- ▶ Under normal circumstance, it will take spiral rout when it detects plenty of large particles, and take fan-shaped route when few of small particles.
- ▶ If take this mode, the cleaning coverage would reach maximum compared by the same size area. We recommend this mode as common domestic one.

Border Cleaning Mode

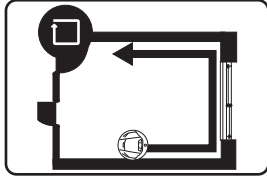

Route description: under this mode, once the robot detects objects, it would run along it, like wall, to clean until it meets obstacle and change the former route.

- ▶ Under this status, robot helps to remove the corner of wall, table, sofa and bed where it is beyond the mode of automatic cleaning.
- ▶ The operation of this mode takes around 25 minutes and then robot goes back to charging block by itself.

Fixed Point Cleaning Mode

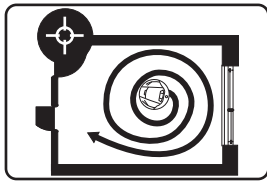

Route description: under this mode, robot runs from inside out shaping spiral and focuses on the certain point to clean for one time. The cleaning coverage is a round shape with diameter of 1.2 meter.

- ▶ This mode is applicable to certain area with plenty of dust.
- ▶ Under common circumstance, the cycle of one fixed point cleaning takes not more than 6 minutes. During operation, if robot continually meets obstacle or detects staircase, it would shift to avoid obstacle and staircase to turn back to work under this status.
- ▶ Robot shall stay where it stops and give tip music after finishing.

Intensive Cleaning Mode

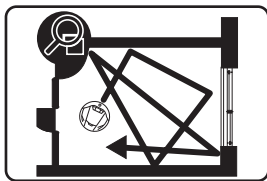

Route description: under this mode, robot takes the same route as automatic cleaning. It would search for charging block by itself before it runs of battery.

- ▶ Under the same ground circumstance, the cleaning effect is the best.
- ▶ If the ground is quite dirty, we recommend this mode.

Go Back Charging Mode

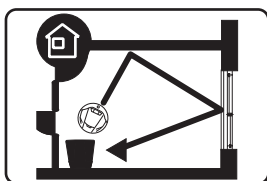

Route description: robot will search for charging block automatically when it detects low battery, what's more, green light flashed once the charger is connected.

7. Automatically Charging

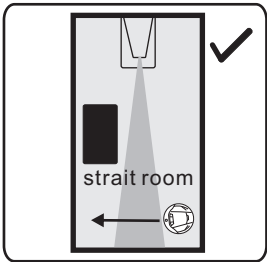
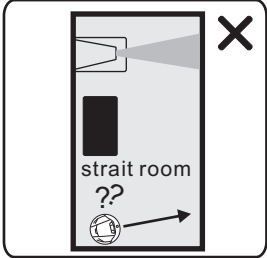
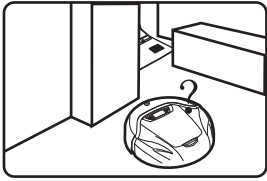

- When it finishes cleaning or there is low battery, it would seek charger in same route as automatic cleaning. To make it easy for robot to search for charging block, you need to put the block back to the wall and make sure there is no obstacle within 1.5 meters ahead of the infrared receiver. Check carefully whether there is strong reflector in front of the charger, such as ground glass, smooth ceramic vase and so on.
- It takes time for robot to seek the charger. The reserve time differs from the ground situation.
- Robot can return to the charger if the ground situation is not too complicated. Under extreme circumstance, such as, huge house and complex layout would probably bring difficulty for robot to seek for charger. In such case, you should help to put the robot back to charger.
- Take care of the first automatic charging, if you find that the robot keeps turning in the certain area after trying several times to seek back, you can help to place it on the charger and look through the charging.
- Under mode, main brush will stop working and robot cannot do the cleaning.
- Robot shall stay at the charger when it finishes charging and it transfer to small currency to charge until you start operating. If you have set appointment timing cleaning, it would go out of the charger to do cleaning when it comes to appointment time.

8. Appointment Timing

Appointment Time Setting

First time setting

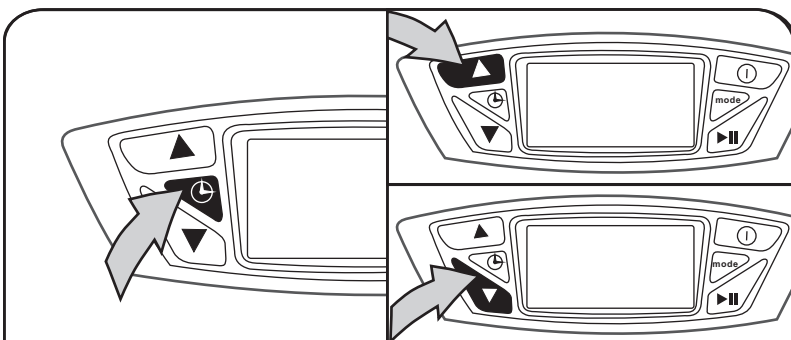

Tips:

- Selection scope: hour is between 0 and 23, minute is between 0-59.
- Under normal circumstance, time display on LCD shows current time.

1. After power is on, keep press for around 3 seconds then on LCD is light and the number with time setting is flashing.
2. Set hour and minute via and , each time press will increase one hour or minute. While decrease one hour and minute for .
3. When you finish setting time, press again, and then go to second time setting.

For example:

Set current time as 12:07 pm, time display on LCD should be:



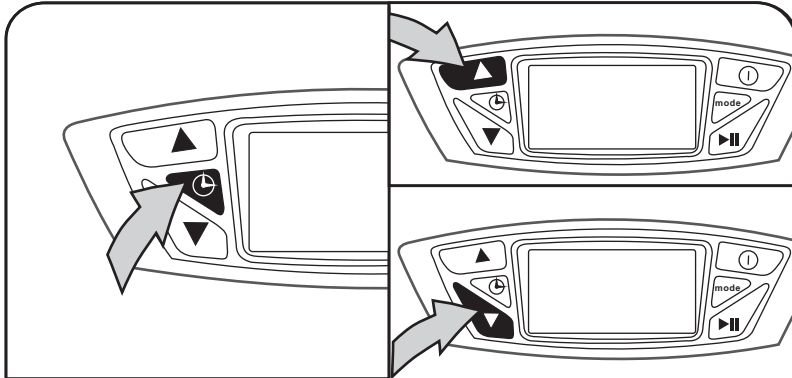

Second time setting



Tips:

- Selection scope: hour is between 0 and 23, minute is between 0-59.
- Under normal circumstance, time display on LCD shows current time.

1. Now, the  label high light, and the number with time setting is flashing.
2. Set hour and minute via ▲ and ▼, each time press ▲ will increase one hour or minute. While decrease one hour and minute for ▼.
3. Press  again, and then go to current time setting.

For example:

Set current time as 2:08 am, time display on LCD should be:



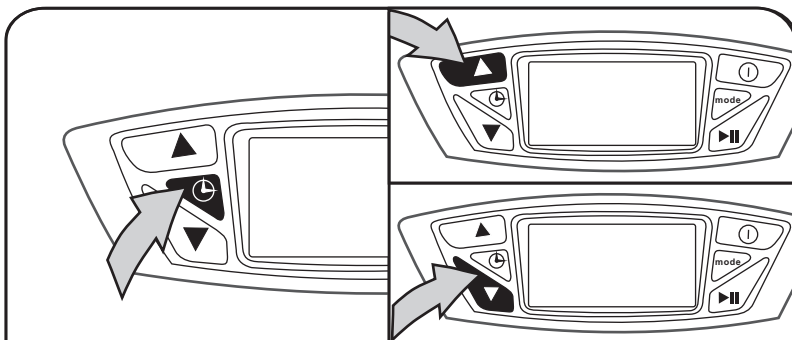

Current time setting



Tips:

- Selection scope: hour is between 0 and 23, minute is between 0-59.
- Under normal circumstance, time display on LCD shows current time.

1. After second time setting, and then go to the current time setting. The  disappeared, and the number with time setting flashing.
2. Set hour and minute via ▲ and ▼, each time press ▲ will increase one hour or minute. While decrease one hour and minute for ▼, and then press  to confirm.
3. Then go to the frequency setting.

For example:

Set current time as 12:07 pm, time display on LCD should be:



Tips:

- ▶ If you need to cancel first or second timing, please repeat set cleaning time, set the time as 00:00. Then the label  will disappear.
- ▶ The time interval between two time setting should be more than 4 hours.

⚠ Note



- ▶ When power is off, robot will not start work on appointment time .If you have already set appointment time cleaning, please turn on the robot and keep it on standby status, even though it is not operating. Try to make it stay at the charger and check whether it is connected.
- ▶ Make sure the socket is connected to power supply. Or else, robot will fail to work on appointment time under standby status because of running out of battery.

Set Frequency and Cancel Timing

Tips:

- ▶ No matter what kind of mode the robot operated in the last time, when the appointment time coming, robot will work according to the Automatic mode.
- ▶ If the robot is operating in Border cleaning mode, Fixed point cleaning mode, when the appointment time coming, robot will not work until the next appointment time.

You can set appointment cleaning frequency via press  then release.

-  to clean on appointment time for one time.
-  to clean on appointment time everyday hereafter.
-  to cancel appointment timing, robot only works upon your manual operation.

Press the key , the robot will work as belowing sequence:



9. Remote Control

Battery Placement

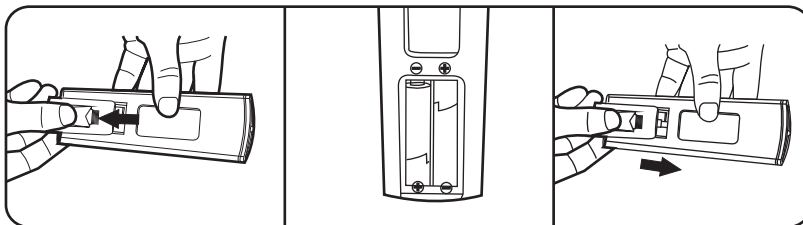

Tips:

- ▶ It applies two units of alkaline batteries (7#).
- ▶ Please note the positive and negative when place the battery.
- ▶ Change the battery when you notice it is in low battery and make sure you use the same kind of battery as mixture is forbidden.
- ▶ Take out the battery if you do not use remote control for long time to avoid electrolyte from leaking which may cause failure.
- ▶ Do not put the remote control in extremely hot or humid surroundings.
- ▶ Do not fill any other substance into remote control, especially when you change battery.
- ▶ Never expose the signal transmitter under sunshine or lighting equipment, or else it would cause failure.
- ▶ The deposal of used battery should conform with local environmental legislation.

Use of Remote Control

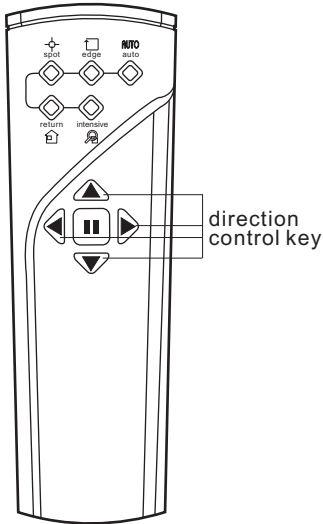

You can control the robot via remote control.

- Drive robot to appointed area via using direction control button.
- Choose certain working mode according to different

AUTO Automatic Cleaning Mode / **Border Cleaning Mode /** **Fixed Point Cleaning Mode /** **Intensive cleaning mode /** **Go Back Charging Mode**

Pause key: temporarily stop current operating and make it stay where it is.

Direction control key: There are four direction control, ahead, backward, left hand and right hand. You can use remote control to drive robot to any appointed area.

- You can control cleaning mode, going back charging and direction within five meters through the function key on it.
- If the robot is under cleaning mode or going back charging, please press pause first and then can proceed direction control.
- During the direction control, robot is not able to operate cleaning.
- Make sure the power supply of remote control is on before you use it. When you use it, match the signal transmitter with signal receiver on the host.
- If robot is near charger, virtual wall or other infrared transmitter, it would be interfered by infrared and fails to receive the signal of remote control, under this situation, please manually operate the mode on the host.

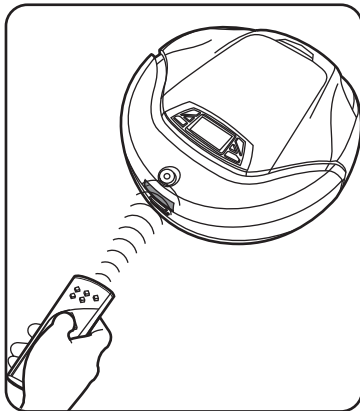

10. Virtual Wall

Battery Placement

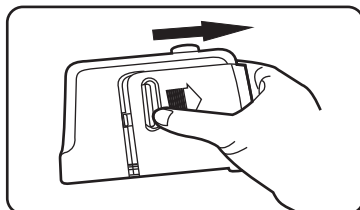

Tips:

- ▶ It applies two units of alkaline batteries (1#).
- ▶ Please note the positive and negative when place the battery.
- ▶ Change the battery when you notice it is in low battery and make sure you use the same kind of battery as mixture is forbidden.
- ▶ Take out the battery if you do not use remote control for long time to avoid electrolyte from leaking which may cause failure.
- ▶ Do not put the remote control in extremely hot or humid surroundings.
- ▶ Do not fill any other substance into remote control, especially when you change battery.
- ▶ Never expose the signal transmitter under sunshine or lighting equipment, or else it would cause failure.
- ▶ The disposal of used battery should conform with local environmental legislation.

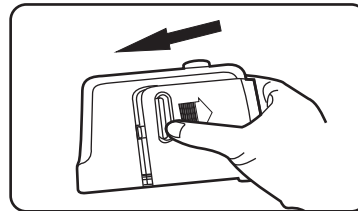
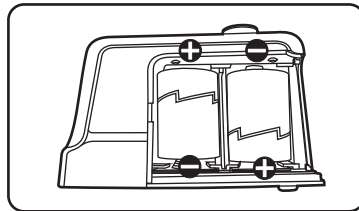
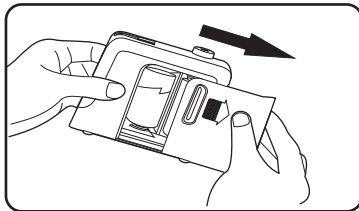

! Note:

- ▶ When you use virtual wall, please face marked ECOVACS to the block area you expect.
- ▶ Put virtual wall outside of the room you want to block to get best effect.
- ▶ The system would cancel virtual wall after it is set for two hours in order to save battery. As a result, every time the robot start new task and there needs to use virtual wall, please do and check whether the switch on virtual wall is on and there is indicator.
- ▶ If you have paused the host for long time during its operation, please examine frequently that if the switch is off to prevent from danger.

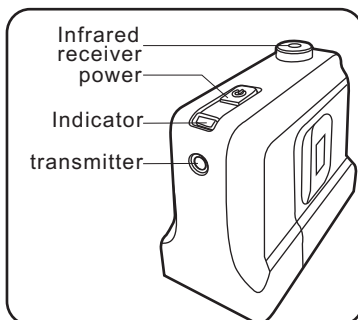

Power: Press this key and virtual wall starts work which will prevent robot from entering the blocked region.

Indicator: It is red when the power is on, and it shows virtual wall is ejecting invisible beam to prevent robot form entering the blocked region.

Infrared transmitter: Ejecting invisible beam.

Infrared receiver: Receive invisible beam.

Use of virtual wall

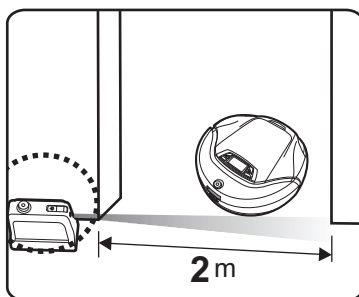

It can be used to control the robot working within room or the certain region you want it to clean. It applies invisible infrared beam to get 2 meters optical band, which forms a blocked open area, such as doorway of the room, corridor and staircase. You can apply virtual wall to stop robot getting close to the wire of domestic appliances or computer and precision object.

- Virtual wall can be put at the entrance of block region. You are allowed to combine several walls together if necessary.
- The beam of virtual wall would form a conical-shaped region to block robot. The virtual wall shall have beam around itself to prevent robot from getting closer to it.

If you find the indicator becomes weaker or that robot is able to enter blocked region, please examine the battery of virtual wall. Change into new battery if necessary.

11. Border Tape

Border Tape Instruction

Border Tape is used to confine the cleaning area. Deebot will not proceed beyond the border, allowing Deebot to clean a designated area.

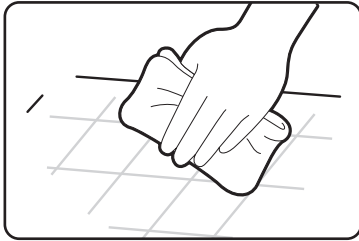

- 1 Clean the area where you plan to paste the Border Tape with a dry cloth.

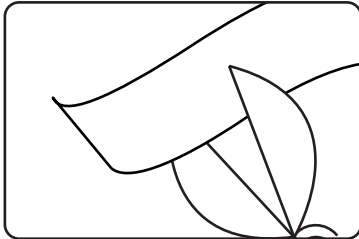

- 2 Unroll the Border Tape and cut the length according to your needs.

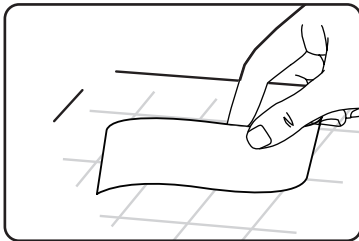

- 3 Paste the Border Tape on the floor after tearing off the white layer on one side.

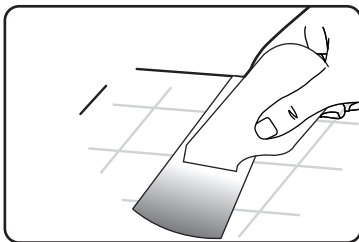

- 4 Rub the Border Tape with Border Enhancement Tool.

Note:

1. Do not paste the Border Tape within a 1.5-meter radius vicinity of the Charging Station, or Deebot will not be able to return for charging.
2. Please make sure the area is dry, or the Border Tape might come off.
3. When the magnetic field deteriorates, please use Border Enhancement Tool and rub on the Border Tape.
4. If surface that have different heights, always paste the Border Tape on the higher side.
5. Border Tape can be pasted on the floor, ceramic tiles, or any hard floor. Please do not paste it on carpets, as it will come off easily.
6. Please keep the Border Tape in a dry and cool place.

12. Day-to-day Storage

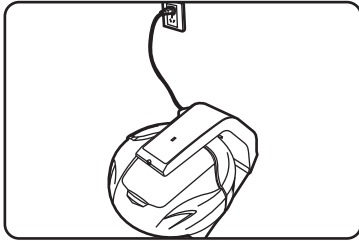

- You should keep robot stay at charger even though it finishes charging and cleaning task, because it will change to small currency to supplement charging.
- Charge the robot until full battery and put it back to the package if you do not need to use it for long time(at least over three months). Keep the package in dry surroundings to avoid sunshine or humidity.

13. Maintenance

The Host Cleaning

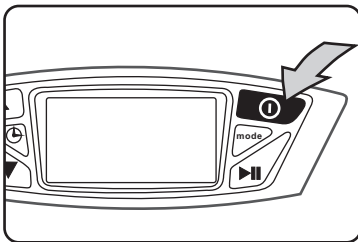

- Turn off the power before cleaning the host.
- Draw out the plug of charger before cleaning the block.
- Do not use petrol or oil-like to clean the surface, while you can use water or neutral detergent to scrub. Make sure you use dry cloth to wipe, because any water is not allowed to infiltrate into the machine.

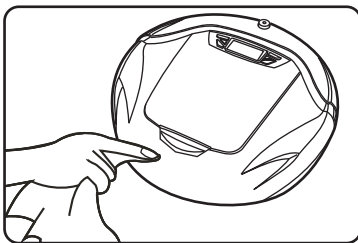

Dust box cleaning

Please follow belowing steps:

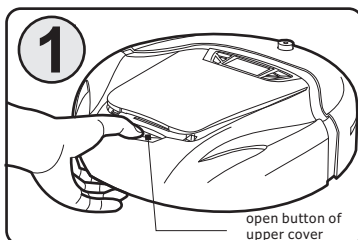

- turn off power.
- press "open" button.
- Take off the cover of dust box.

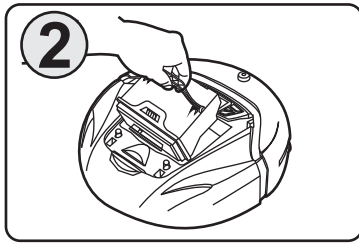

Hold the handle of dust box and lift it to take out.

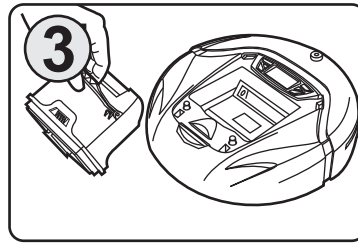

In order to avoid dust leaking, lift the suction up when you take out dust box. Please mind your speed doing this step.

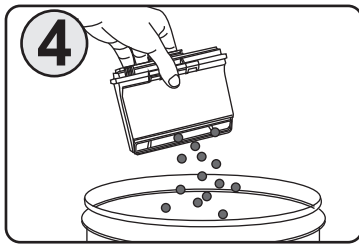

Match the bottom with trash can and swing dust box gently. You can mildly beating it along the edge of the can to get the dust out.

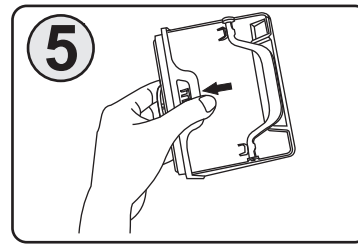

If you notice that there is too much dust on sponge filter, you can open the lock and take off the cover.

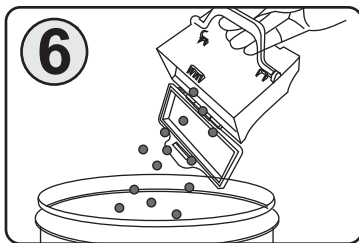

Pour out the dust on sponge filter.

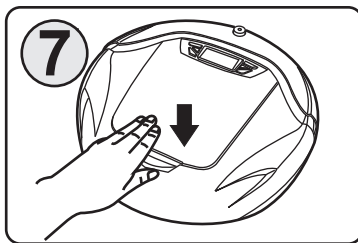

Close the cover and hear "kaca" sound which shows that it is placed. Put the dust box back into the host and cover it.

Tips:
If the dust box is not placed back or not properly placed, robot will alarm and show red indicator on LCD.

Sponge filter and dust box cleaning

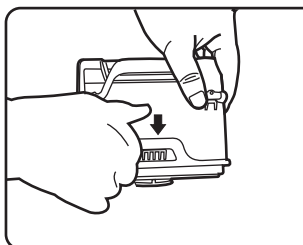

Open the lock at the bottom of dust box.

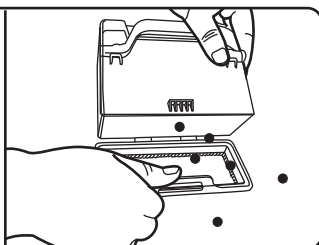

Pour out the dust on sponge filter.

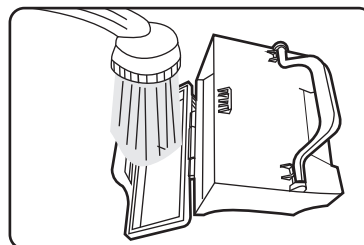

If you notice that there are too much dust on inside along dust box, you can put the box under running water to get rid of the dust. (make it dry under sunshine for 24 hours)Put it back into the host after the box and sponge filter is completely dry.

Sponge Filter Replacement

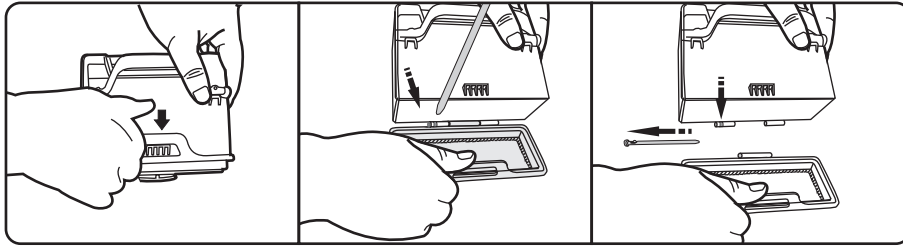

1. Open the cover of the Deebot, take out the dust box.
2. Push aside the lock catch of the dust box, then open the dust box and clean it.
3. Extract the axle of the dust box's cover.
4. Replace the sponge filter and fix the cover, then put it back into Deebot.

Main brush cleaning

Tips: Clean the main brush after it has operated for 4 or 5 recycles.

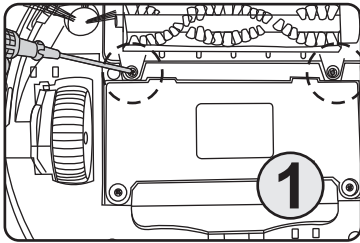

Undo the screw fixed on the main brush.

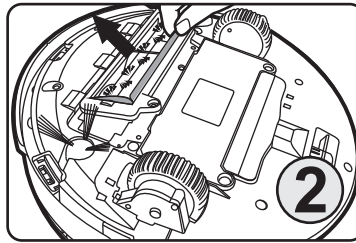

Take off the frame of main brush.

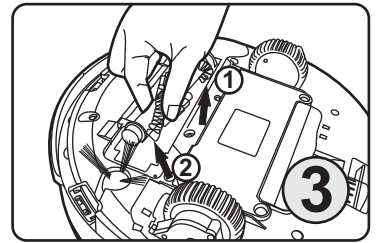

Take out one side of main brush from the belt.

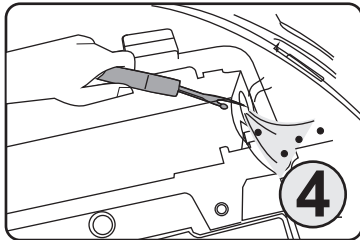

Remove the hair and dust which is in-between the belt.

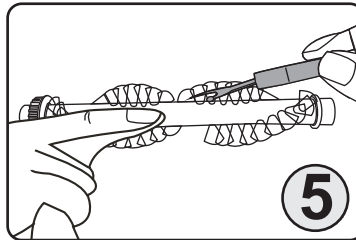

Rip off the hair on main brush (with equipped roll brush cleaning gadget to break off the hair on main brush along the groove).

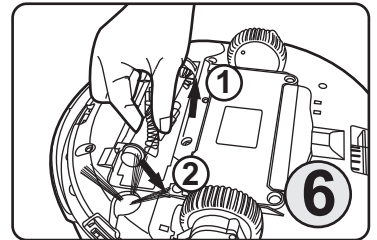

Wipe the dust on the roller and put it back.

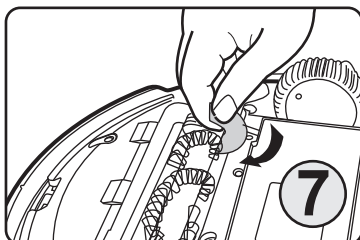

Put the main brush back to the host and take care of the anastomosis of belt.

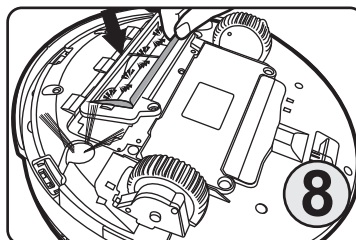

Fix the frame into host.

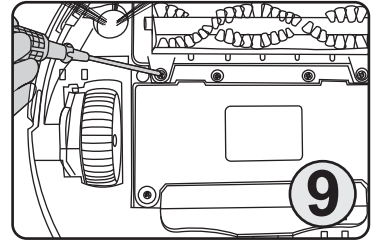

Tie up the screw.

Side brush cleaning

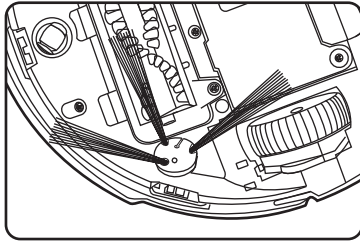

Side brush is a kind of easy wear part. We suggest you to check it every time it takes cleaning task. Please change it if necessary.

⚠ Note:

The host will alarm when the side brush tangles and it will show on LCD as .

Replace sidebrush

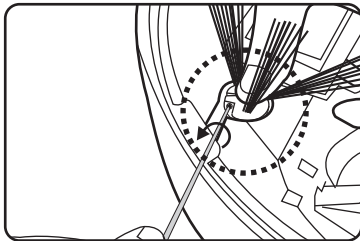

Please remove the screws, and take out the side brush.

Please replace the side brush when it is destroyed.

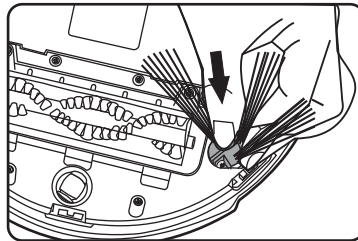

Please push the new side brush into the correct position.

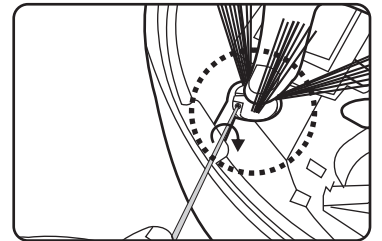

Tight the screws.

Driving wheel cleaning

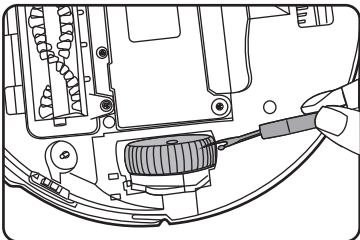

Use roll brush to remove the dust or hair on driving wheel.

⚠ Note:

If the wheel is tangled by hair or cloth, the host will alarm and it will show on LCD as .

Up-ground height sensor cleaning

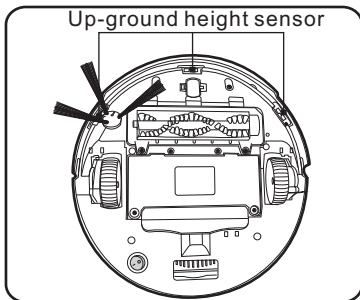

Up-ground height sensor is on the front bottom of robot. It can detect the height difference within 8 centimeters. We suggest you to wipe the optical board with dry cotton cloth after it finishes task to prevent the dust piling on it which would affect its performance.

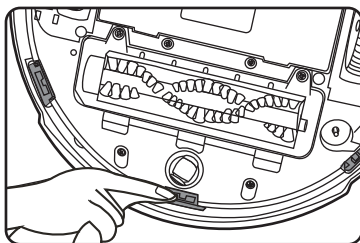

1. Turn off the power and remove the trash inside dust box.
2. Invert the robot, then put it on the even and clean platform.
3. Use dry cotton cloth to wipe three pieces of optical board of up-ground height sensor.

Dust sensor cleaning

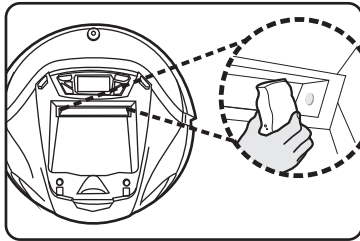

The dust sensor is located at the front of dust entrance. It is able to detect the concentration of dust so that it can choose efficient mode to work. We suggest you to clean dust sensor once you clean dust box to improve work efficiency.

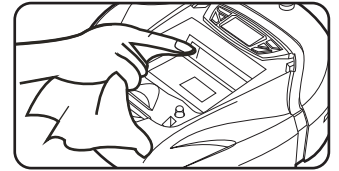

1. Turn off power.
2. Take out dust box and clean it.

14. Alarm Function



Note:

The robot will stop working under following circumstance; there will be alarm and tip sound at the same time. What's more, LCD will have red light flashing. Please notice the tip on LCD.

Icon	Cause of failure	Solution	Instruction
	<ol style="list-style-type: none"> 1. There is too much dust in dust box. 2. There is too much dust on dust sensor. 	<ol style="list-style-type: none"> 1. Clean dust box. 2. Clean dust on up-ground height sensor. 	In order to extend use life, robot will alarm even though there is not much dust inside, after several cycles cleaning.
	<ol style="list-style-type: none"> 1. Dust box is not fixed into host. 2. Dust box is not fixed properly. 	<ol style="list-style-type: none"> 1. Put dust box back into host. 2. Re-install dust box and press it down at the same time. 	
	<ol style="list-style-type: none"> 1. Main brush or driving wheel is tangled by hair or cloth. 2. Side brush is blocked. 	<ol style="list-style-type: none"> 1. Clean main brush 2. Clean side brush and put it back. Must change it if necessary. 	
	Driving wheel is suspended.	Put the robot back on the charging block to charging.	This function can prevent danger of child or pet lifting the robot when it is operating.
	Low battery.	Put the robot back manually.	

15. Common Failure

No.	Problem	Solution
1	Robot keeps proceeding or moving backward once power is on.	<p>Turn off the power.</p> <ol style="list-style-type: none"> 1. Check if there is dust on up-ground height sensor, which cause robot to make wrong signal. Use half dry cloth to clean it. 2. Buffer collision is out of control. Put your hand at left, middle and right in turn to see if it can rebound by itself.
2	Robot is in trouble.	<p>Robot may fall in trouble when it is working. In such case, it will try every possibility to get out of trouble, but it shall stay at a certain place when it fails and starts alarm. You should help it and get rid of the obstacle.</p> <p>The trouble may be as follows:</p> <ol style="list-style-type: none"> 1. It is tangled by power cord. 2. It is tangled by hanging curtain or fringe.
3	Robot fails to detect the stairs.	<p>Robot is able to detect most of the stairs within 8 centimeters height difference. However, its performance will weaken when it is smooth floor with height difference or the floor with strong reflector. You can put virtual wall under this situation to prevent it from falling off.</p>
4	The capacity to clean weaken.	<p>Turn off power and take out the dust box., then follow the steps as below:</p> <ol style="list-style-type: none"> 1. Check whether there is too much dust on sponge filter so that it needs to change it. 2. Make sure there is no dust which blocks the suction. 3. Take out main brush and clean it. Insure the both ends of main brush is not tangled by hair or fiber. Fix it back after it is been cleaned. 4. Examine if there is dust or debris near driving wheels. 5. Clean dust sensor <p>If the failure still there after following the steps above, please contact our after-sales.</p>

5	<p>There is much noise when the robot works.</p>	<p>Turn off the power supply, and then take out of dust box. After removing the garbage, overturn the robot.</p> <ol style="list-style-type: none"> 1. Check whether the suction of main brush is blocked. 2. Examine and clean the main brush(at both ends). 3. Examine and clean the side brush. <p>If the failure is still there after operating according to the above procedure, Please contact out after-sales service.</p>
----------	--	--

16. Other Problems

<ol style="list-style-type: none"> 1. How much reserve time for robot go back charging? Answer: It differs from the ground situation, 2. How long can robot last working under full battery? Answer: It differs from the ground situation, It takes around 60 minutes for even floor such as wooden floor and ceramic tile, and 20 minutes for short-haired carpet. 3. Is it allowed for the robot to work independently without taking care of? Answer: Yes. However, you should keep person in the room informed about robot operating to avoid tripping. 4. What kind of equipment inside the robot is used for dealing with failure? Answer: It is equipped with photosensitive components which can detect the stair over the height of 8 centimeters; for fear that it would fall over. 5. Is robot able to clean the bottom of the furniture? Answer: It is flat design, during normal cleaning, it can go into table and bed corner whose height is over 10 centimeters, such as bed, wardrobe, sofa and tea table. 6. Why does robot fail to work under set 	<p>mode?</p> <p>Answer: Because when there is low battery, it will do back to charging mode automatically.</p> <ol style="list-style-type: none"> 7. What's the cleaning coverage once it is charged full?(under automatic cleaning mode) Answer: Under normal circumstance, it is around 120-150 sq, but it differs from the ground situation. 8. Why does robot stop working once it meets obstacle? Answer: Under normal circumstance, robot will return or seek other route when it meets obstacle. However, if it controlled by remote control, it is not able to change route in case of obstacle. 9. Why there is garbage leaking from the machine while robot operating? Answer: a. Please check whether there is too much garbage in dust box(if there is too much dust on the floor, robot is not able to alarm after working for some time even though there is too much garbage in dust box.). That's why you need to clean dust box. b. See whether main brush is not cleaned for long time, as it is tangled with much hair and dust.
--	--

10. Why does robot fail to start cleaning on appointment time?

Answer: a. Confirm whether there is much remaining battery. Appointment timing is not applicable when robot is returning to charge after operating cleaning. b. Check if robot is under standby status.

11. Why robot is not charging as it is put in the charger? The charging indicator does not light as well.

Answer: a. Examine whether the battery at the bottom is installed in place, if cover screw is loose, you need to fasten it. b. Check if there is power supply for the socket. c. Please contact our after-sales service when the failure is still there.

12. Why does not the remote control work?

Answer: a. The control distance is within 5 meters. It would be insensitive if longer distance. b. Check battery in remote control and make sure it is placed correctly. c. Insure robot power supply is on, please get it charged when you notice it shows low battery on LCD. d. Use clean cloth to wipe infrared transmitter on remote control and infrared receiver on robot. e. If the host is too close to virtual wall or charger, the signal of remote control will get interfered.

13. Why does not virtual wall work?

Answer: a. Insure the region blocked by invisible light from virtual wall, which is the region you do not want robot to get across. b. The signal will get interfered if virtual wall is too close to the charger. c. Check whether the region you want is beyond the virtual wall, we suggest you to purchase additional virtual wall if necessary.

14. Would it be difficult for robot to clean the corner as it is a round design?

Answer: Robot can detect wall by itself. It is able to clean along the edge of wall under automatic and border cleaning mode. Its

side brush can remove dust along bottom edge efficiently; there would be dust beyond robot in the tiny area formed by two walls which need to be removed by hand.

15. Why does the speed of robot slow down sometimes?

Answer: When robot detects there is much garbage and dust on the floor, it would turn to low speed proceeding automatically.

16. Is there any danger to furniture and child when robot is proceeding?

Answer: No. There is a soft rubber buffer made of PPC in front of the host. It would try other route once it touches furniture or child.

17. Would robot affect pet?

Answer: Robot makes low noise when operating, so there would be no shrill sound which may cause pet restless or even distrust. If you keep pet at home, we suggest you to notice the first time the robot operating.

18. What should be noticed when cleaning the carpet?

Answer: Robot is not able to clean long hair over 2 centimeters. Fold the banding first when you start cleaning.

19. Does it matter to keep the robot at the charger when not using it?

Answer: Yes. Robot will transfer to small currency to supplement charging. Please avoid wrong operation by child.

20. Is there any danger to wrongly touch the docking electrode film between the host and charger?

Answer: No. The two electrodes of charger is of no voltage under output mode (when there is no power supply); its maximum voltage is 24V which is safe one under input mode (when it is charging)

21. How does main brush avoid being tangled by power cord?

Answer: Robot is probably get tangled by the wire scattered on the floor when it is operating. At that time, robot will try to turn back to get rid of it, and it will make alarm sound when it fails after trying several times.

22. How can I stop the robot from operating on appointment time since I will be away from home for sometime?

Answer: You can cancel appointment cleaning.

23. How can I transfer my robot?

Answer: You can lift it up with both your hands and lay on the ground quickly, dust and garbage in dust box will come out if it is not place back in time.

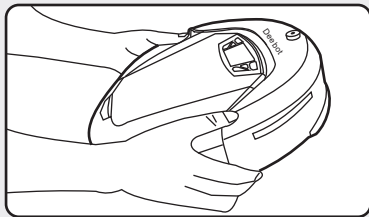

24. How to use robot most effectively?

Answer: Put the robot and charger in the same room, because it would shorten seeking time and it can extend the working time. If you need robot to clean every room of house, you should put the charger in the middle of house for the convenience of go back to the charging block.

25. What should do if robot sucked liquid?

Answer: a. Turn off the power and take out dust box, then empty it and wipe it dry. b. Draw out the sponge filter and wipe it dry. c. Take out main brush and clean it, then use day cloth to wipe the brush and its interior. Wait until the brush is day and place it back. d. Let the product dry by itself for at least 12hours(make sure circuit board is dry and then get power on).

If the procedures above still do not make it work, please contact our after-sales service.

Enjoy smarter life!

ECOVACS