

BOMANN®

HOUSEHOLD DISHWASHER GSP 862

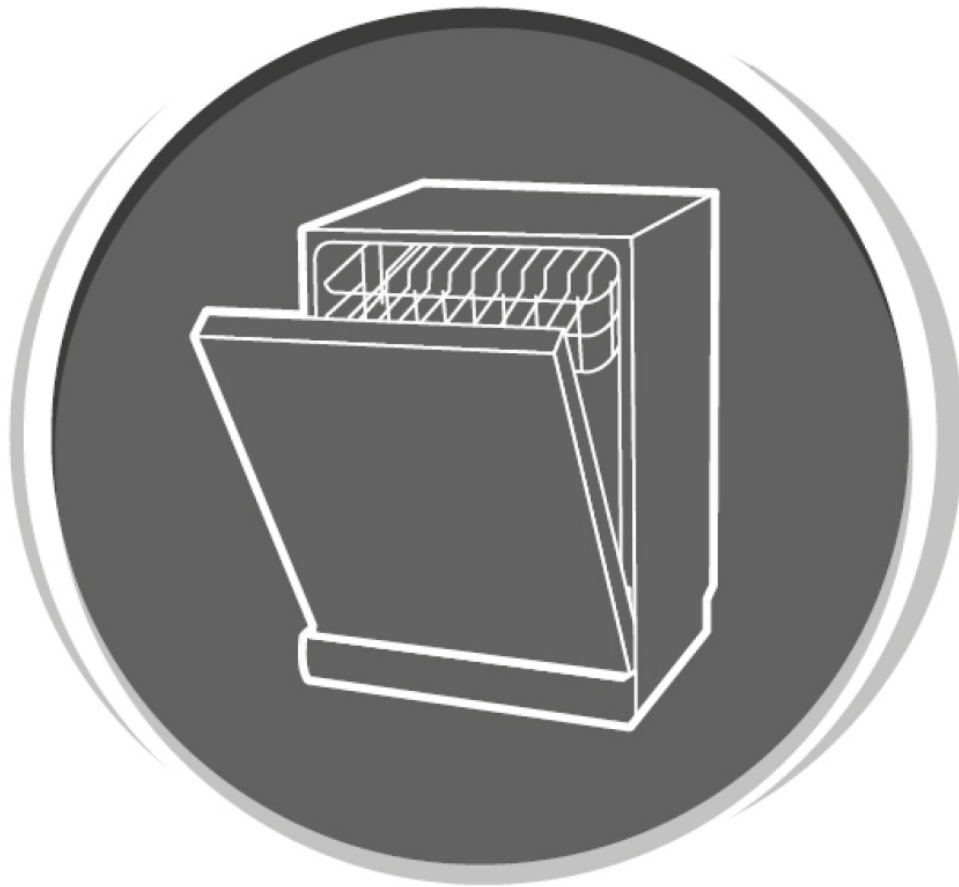

Instruction Manual

CE

Contents

Introduction	Page 3
General Notes	Page 3
Special safety Information for this Unit	Page 4
Unpacking the Appliance	Page 5
Appliance Equipment	Page 5
Installation	Page 5
Prior Using for the first Time	Page 7
Loading the Dishwasher	Page 9
Startup / Operation	Page 11
Cleaning and Maintenance	Page 13
Troubleshooting	Page 15
Technical Data	Page 16
Disposal	Page 16
EU Product Data Sheet	Page 17

Introduction

Thank you for choosing our product. We hope you will enjoy using the appliance.

Symbols in these Instructions for Use

Important information for your safety is specially marked. It is essential to comply with these instructions to avoid accidents and prevent damage:

WARNING:

This warns you of dangers to your health and indicates possible injury risks.

CAUTION:

This refers to possible hazards to the machine or other objects.

 **NOTE:** This highlights tips and information.

and disconnect the plug (pull the plug itself, not the lead) or turn off the fuse.

- The appliance and if possible the mains lead have to be checked regularly for signs of damage. If damage is found the appliance must not be used.
- For safety reasons, alterations or modifications of the appliance are prohibited.
- In order to ensure your children's safety, please keep all packaging (plastic bags, boxes, polystyrene etc.) out of their reach.

WARNING:

Do not allow small children to play with the foil. There is a **danger of suffocation!**

General Notes

Read the operating instructions carefully before putting the appliance into operation and keep the instructions including the warranty and the receipt. If you give this device to other people, also pass on the operating instructions.

NOTE:

Illustrations can deviate from the original appliance.

- The appliance is designed exclusively for private use and for the envisaged purpose. This appliance is not fit for commercial use.
- The appliance is only to be used as described in the user manual. Do not use the appliance for any other purpose. Any other use is not intended and can result in damages or personal injuries.
- Do not use it outdoors. Keep it away from sources of heat, direct sunlight and humidity.
- Do not operate the appliance **without** supervision.
- When not in use, for cleaning, user maintenance works or with disruption, switch off the appliance

Special safety Information for this Unit

- The maximum number of place settings to be washed is 12.
- This unit is intended to be used in household and similar applications such as
 - staff kitchen areas in shops, offices and other working environments;
 - by clients in hotels, motels and other residential type environments;
 - in farm houses.
- The appliance is to be connected to the water mains using new hose sets and that old hose-sets should not be reused.
- The maximum permissible inlet water pressure is 1 Mpa.
- The minimum permissible inlet water pressure is 0.04 Mpa.
- In the appliance bottom are located ventilation openings (depending on model). These may not be clogged e.g. by carpet.
- Pay attention to a proper loading of the appliance. Follow the instructions in the chapter “Loading the Dishwasher”.
- Knives and other utensils with sharp points must be loaded with their points down in the cutlery basket (depending on model) or placed in a horizontal position in the dishwasher basket.
- The door should not be left open, since this could increase the risk of tripping.
- This appliance can be used by **children** aged from 8 years and above and persons with reduced physical, sensory or mental capabilities or lack of experience and knowledge if they have been given supervision or instruction concerning **use of the appliance** in a safe way and understand the hazards involved.

- **Children** who are younger than 8 years must be kept away from the device.
- **Children** shall not play with the appliance.
- Cleaning and **user maintenance** shall not be made by **children**, unless they are older than 8 years and are supervised.
- Do not try to repair the appliance on your own. Always contact an authorized technician. If the supply cord is damaged, it must be replaced by the manufacturer, its service agent or similarly qualified persons in order to avoid a hazard.

Unpacking the Appliance

- Remove the appliance from its packaging.
- Remove all packaging material, such as foils, filler and cardboard packaging.
- To prevent hazards, check the appliance for any transport damage.
- In case of damage, do not put the appliance into operation. Contact your distributor.

i NOTE:

Production residue or dust may have collected on the appliance. We recommend cleaning the appliance according to chapter "Cleaning and Maintenance".

Delivery scope

1x cutlery basket, 1x cup shelf, 1x salt funnel tube, 1x inlet hose

Installation

⚠ WARNING:

The unit must not be connected to the mains during installing. Otherwise there is **danger to life** or **electric shock hazard!**

⚠ CAUTION:

For a correct operation the appliance must be connected properly. The specifications for water supply and drain as well as the electrical connection must fulfill the required criteria.

Appliance Equipment

Appliance Overview

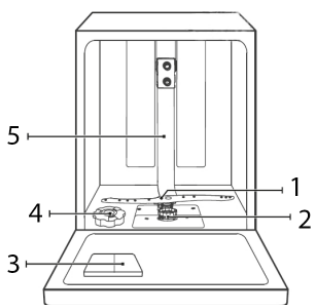

- 1 Lower spray arm
- 2 Filter system
- 3 Dispenser
- 4 Salt container
- 5 Inner pipe

Installation location

- The site should be located near the water inlet and outlet, as well as near a properly grounded power socket.
- Place the appliance so that all controls are easily to reach and the appliance door can open without being impeded.

- Take care of a solid and horizontal position of the appliance. If the appliance is not horizontally leveled, adjust the feet accordingly (see “Adjust the feet”).
- Power cord and water hoses may not kinked or squashed.
- **Avoid the installation:**
 - near heaters, next to a stove, direct sunlight or any other heat sources;
 - at locations with high humidity (e.g. outdoors), as metal parts would be susceptible to corrosion under such circumstances;
 - in rooms where the temperature could drop below freezing. Do not expose the appliance any weather.
 - near volatile or flammable materials (e.g. gas, fuel, alcohol, paint, etc.).

Removing the appliance cover

The appliance cover can be removed and thus reducing the device height to 81.5 cm; to place the dishwasher under a suitable kitchen worktop.

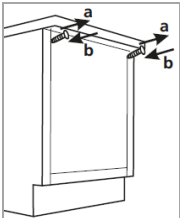

- Loosen the screws on the unit back and remove the cover.
- After removing the cover, retighten the screws.

Adjusting the feet

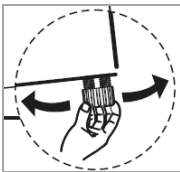

Check with a spirit level whether the appliance is leveled horizontally. If the unit is not in balance, the feet must be adjusted.

Water connection

⚠ CAUTION:

- The Installation of the water supply must conform to the local laws and regulations.
- The appliance is **not** suitable for hot water supply.

⚠ CAUTION:

- Use the new supplied hose set to connect the appliance to the water supply. Do not reuse old or used connection sets.
- If the water pipe is new or long time not used, ensure before connecting to the water system, that the water is clear and free from contamination.

Notes on inlet hose safety system (delivery scope depending on model)

The safety system consists of a double-walled inlet hose. It guarantees to cut off the water supply when leakage of the inner hose. Switching off the water supply leads over an electronic contact.

If necessary, you can order an inlet hose safety system from your dealer or in our online accessories shop, www.bomann-germany.de. To order, use the reference number found under “Technical Data”.

Connect the water inlet hose (cold water connection)

ⓘ NOTE:

The water pressure must be between 0.04-1.0 MPa. With higher pressure: use a pressure regulator.

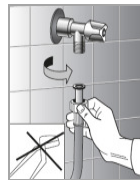

- Connect the water inlet hose to a water thread with $\frac{3}{4}$ ". Screw the hose firmly in the direction of the screw thread; pay attention for a tight fit.

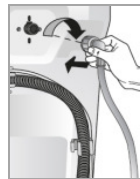

- Connect the other end of the inlet hose to the inlet valve on the appliance back; pay attention for a tight fit too.

Connect the water drain hose

ⓘ NOTE:

The drain hose has a length of approx. 1.5 m and can extend with a suitable hose and connecting piece to a length of max. 4 m.

⚠ CAUTION:

In order to prevent backflow of contaminated water, the free end of the hose must not come under the water level of the drain.

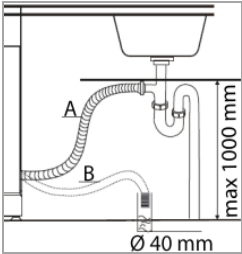

- Connect the drain hose to a drain pipe (B) with a minimum diameter of 40 mm; alternatively the drain hose can be fixed directly to the sink (A).

- Always make sure that the hose is not bent or squeezed.
- It is allowed to install the hose maximal up to a height of 1000 mm above the rinsing floor.
- Secure the drain hose securely to avoid a change in position and with it a water leakage.

Electrical connection

⚠ WARNING:

- The installation to the mains supply must conform to the local standards and regulations.
- Improper connection may cause to an **electric shock!**
- Do not use multiple sockets or extension cords.
- It is not allowed to modify the plug provided with the appliance! If the plug does not fit properly to the outlet, let install a proper outlet by an authorized specialist.
- The accessibility of the power plug must always be ensured in order to disconnect the device from the power supply in case of an emergency.
- Make sure that the voltage supply matches the specifications on the rating label (door frame) before connecting.
- Connect the mains cable to a properly installed and earthed wall outlet.
- If the plug after installation is not accessible, a corresponding disconnect device must be available to meet the relevant safety regulations.

Prior Using for the first Time

Before using your dishwasher for the first time:

- A. Filling salt into the salt container (water softener)
- B. Fill the rinse aid dispenser
- C. Fill in detergent

⚠ CAUTION:

- Use only salt, rinse aid and detergent for dishwashers. Other products may damage the appliance.
- Always consider the dosage and storage recommendations on the sales packaging.

⚠ WARNING:

Keep salt, rinse aid and detergent out of reach for children.

A. Filling salt into the salt container (water softener)

Water softener

The water hardness varies regionally. If hard water is used in the dishwasher, deposits form on the dishes and kitchen utensils. The appliance is equipped with a water softener, that removes lime and minerals from the water by using water softening in the salt container. Your local water authority can advise you on the hardness of the water in your area.

Adjusting the salt consumption

The salt consumption can be adjusted according to your water hardness and therefore optimally regulated.

- Turn on the appliance.
- Press the Start/Pause button for more than 5 seconds, the setting mode is now activated for approx. 60 seconds.
- By repeatedly pressing the Start/Pause button the water hardness can be selected: H1->H2->H3->H4->H5->H6. The control lamps indicate the selection (see below table).

- The setting is automatically saved after a few seconds; alternatively end the setup with the Power button.

Water hardness		Setting	Control lamps lights	Salt cons. / cycle
°dH	Mmol/l			
0-5	0-0.94	H1	Rapid	0 g
6-11	1.0-2.0	H2	90 Min.	9 g
12-17	2.1-3.0	H3	90 Min + Rapid	12 g
18-22	3.1-4.0	H4	Glass	20 g
23-34	4.1-6.0	H5	Glass + Rapid	30 g
35-55	6.1-9.8	H6	Glass + 90 Min.	60 g

NOTE:

°dH: German degree of hardness

Factory setting: H3

Fill in the salt

CAUTION:

- Only refill the salt container when the salt warning lamp is lighting.
- During filling the salt container, salt and water can escape. Start a program immediately after you have filled the container to prevent corrosion.

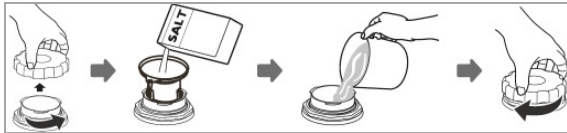

- Remove the lower basket and unscrew the lid of the salt container.
- Add about 1.5 kg of salt by using the supplied funnel tube.
- Full fill the salt container with water (just before the first use).
- Screw the lid firmly on again after filling the container.
- Depending on salt resolution, the warning lamp usually disappears immediately after filling.

B. Fill the rinse aid dispenser

Function of rinse aid

The rinse aid is automatically added during the final rinse, ensuring thorough rinsing and a spot and streak free drying.

When to refill the rinse aid dispenser

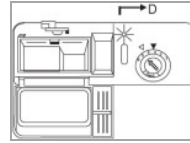

As long as the corresponding message does not light up in the display, you can estimate the amount of remaining rinse aid to the optical level indicator (D) next to the dispenser.

When the rinse aid dispenser is full, the indicator is completely dark. If the rinse aid diminishes, the size of the black dot changes as shown below. In order to avoid spotting, the rinse aid level must not drop below 1/4.

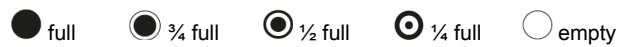

Fill in the rinse aid



- To open the dispenser screw the lid counter-clockwise to the open position and remove the lid.
- Add the rinse aid into the dispenser, being careful not to overfill. The dispenser contains approx. 110 ml.
- Before closing the appliance door, put on the lid in the open position back and turn it clockwise to the closed position.

NOTE:

Remove spilled rinse aid with an absorbent cloth to avoid excessive foaming during the next rinse.

Adjusting the rinse aid dosage

When forming spots and the dishes dries poorly, increase the added amount of rinse aid. You can set the amount of addition between level 1 (min.) and level 6 (max.).



Take off the lid of the rinse aid dispenser and adjust the dial to the desired level.

The factory setting is "4".

NOTE:

Increase the dosage if there are drops of water or lime spots on the dishes after rinsing. Reduce the

dosage if there are sticky whitish stains on dishes or a bluish film on glassware or knife blades.

C. Fill in detergent

Function of detergent

Detergents with its chemical ingredients are necessary to remove dirt, crush dirt and transport it out of the dishwasher. The most commercially, high-quality cleaning agents are suitable for this purpose.

Detergent

Normally new pulverized detergent is without phosphate. Thus the water softener function of phosphate is not given. In this case we recommend to fill salt in the salt container even when the hardness of water is only 6°dH. If detergents without phosphate are used in the case of hard water often white spots appear on dishes and glasses. In this case add more detergent to reach better results. Detergents without chlorine do only bleach a little. Strong and colored spot will not be removed completely. In this case choose a program with a higher temperature.

Detergent tablets (Tabs)

Dishwasher tablets from different manufacturers dissolve at different rates. It is possible that they will not fully dissolve in programs with short running time and low water temperature and thus does not reach their full productive efficiency. To ensure the complete removal of detergent residues, we recommend choosing rinse programs with long running times and high water temperature. Always follow the manufacturer's instructions!

Fill in the detergent

i NOTE:

- Always add the detergent just before starting the rinse cycle, otherwise it could get damp and will not dissolve properly.
- You'll find information about the amount of detergent for the respective programs in the „Program

table“. Note that depending on the degree of soiling and water hardness differences are possible.

- At the end of the rinse cycle the detergent dispenser must be empty.

The dispenser must be refilled before the start of each rinse cycle according to the instructions in the "Program table".

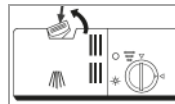

Press the release button to open the dispenser.

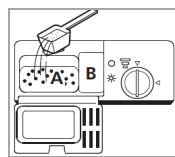

- A** Chamber of detergent in powder form for the main rinse
- B** Chamber of detergent for the pre-rinse / Chamber for detergent in tablet form

The main rinse chamber must be filled at least up to the marking MIN (about 20 g). Add with heavily soiled dishes an additional dose of detergent (about 5 g) in the chamber for the pre-rinse. Close the dispenser. Make sure that the lid locks into place.

Loading the Dishwasher

△ CAUTION:

Only rinse such dishes and cutlery in the dishwasher, which is expressly marked as "dishwasher resistant".

i NOTE:

- Remove gross scraps of food and soak burnt leftovers. Pre-rinse under running water is not necessary.
- Do not overload! This is important for adequate cleaning results and reasonable energy consumption.
- Very small items should not be rinsed in the appliance, as they could easily fall out of the baskets.

For rinsing in the dishwasher the following cutlery and dishes..

..are not suitable:

- Cutlery with hand pieces of wood, porcelain mother of pearl
- Plastic items that are not heat resistant
- Older cutlery with glued parts that are not temperature resistant
- Bonded cutlery items or dishes
- Pewter or cooper items
- Crystal glass
- Steel items subject to rusting
- Wooden platters
- Items made from synthetic fibres

..are limited suitable:

- some types of glasses can become dull after a large number of washes
- silver and aluminum parts have a tendency to discolor during washing
- Glazed patterns may fade if machine washed frequently

Recommendations for loading

- Arrange sensitive, light tableware items such as glasses, coffee and tea cups in the upper basket.
- Place large items that are most difficult to clean in the lower basket.
- Make sure that the tableware is placed securely and cannot tip over.
- Place all items so, that the spray arms can rotate freely during rinsing.
- Arrange all items with openings facing down.
- Curved items, or ones with recesses, should be loaded aslant so that water can drain off.
- Make sure that glasses do not touch each other.
- Set the dishes and cutlery not into each other or covering each other.
- Arrange cutlery in the cutlery basket.

- Store long as well as sharp cutlery horizontally in the dishwasher basket.

Methods for loading normal dishware

Loading the upper basket

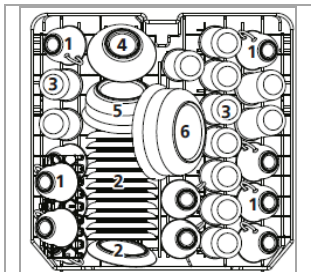

- | | |
|-----------|-------------------|
| 1 Cups | 7 Dessert plates |
| 2 Saucers | 8 Dinner plates |
| 3 Glasses | 9 Soup plates |
| 4 Bowl | 10 Platter |
| 5 Bowl | 11 Cutlery basket |
| 6 Bowl | |

On the upper basket only small and medium items should be loaded. Load e.g. glasses, cups, saucers and small bowls.

Loading the lower basket

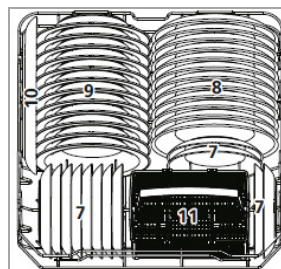

Because of the particularly intense cleaning action of the lower spray arm the lower basket is suitable for heavily soiled dishes. Load e.g. pots and plates.

Cup and plate holders



In order to create a better arrangement for bulky dishes, the cup holders and the plate holders can be folded. Lift the racks slightly and fold them down.

Cup shelf in the upper basket

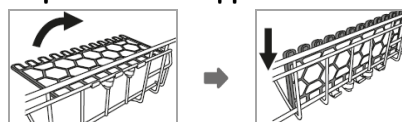

If necessary, fold down or remove the cup shelf.

Adjusting the upper basket

The height of the upper basket can be adjusted by placing the wheels on rails of different heights. This will create more space for large items in the upper as well as in the lower basket.

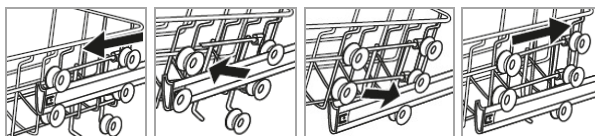

- Pull out the basket guides.
- Remove the basket out of the guides.
- Depending on the desired setting, insert the upper or lower pair of wheels into the guide; both sides should always be located at the same height.

Cutlery basket

⚠ WARNING: Risk of injury!

- Cutlery must not protrude above the cutlery basket base.
- Knives and other utensils with sharp points must be placed with the tip down in the cutlery basket or in a horizontal position in the dishwasher basket.

ℹ NOTE:

If necessary, remove the basket in order to create more space for large dishware.

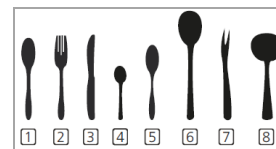
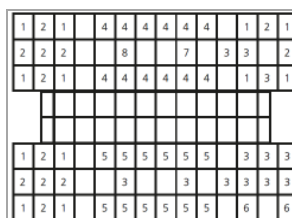

The basket is equipped with grid inserts in which the cutlery is arranged uniformly and with the handles downwards.





Startup / Operation

Program table

Select a suitable program depending on dishes and degree of soiling.

Program	Program selection information	Program sequence	Detergent pre/main (g)	Time (Min.)	Energy (kWh)	Water (l)
 Intensive	heavily soiled dishes and dried leftovers	Pre-rinse (50°C) Main rinse (60°C) Rinse 1+2 Rinse (65°C) Drying	5/25 (or Tab)	170	1.6	18.5
 Normal	normal soiled dishes, daily use	Pre-rinse (45°C) Main rinse (55°C) Rinse Rinse (65°C) Drying	5/25 (or Tab)	180	1.3	15
ECO (*EN 50242)	standard program for normally soiled dishes,	Pre-rinse Main rinse (45°C) Rinse (65°C) Drying	5/25 (or Tab)	190	0.91	11

Program	Program selection information	Program sequence	Detergent pre/main (g)	Time (Min.)	Energy (kWh)	Water (l)
 Glass	low adhesive, fresh leftovers, such as glasses	Pre-rinse Main rinse (40°C) Rinse Rinse (60°C) Drying	5/25 (or Tab)	130	0.9	14.5
 90 Min.	for lightly soiled dishes	Main rinse (65°C) Rinse Rinse (65°C) Drying	30 (or Tab)	90	1.35	12.5
 Rapid	rapid rinse cycle for lightly soiled dishes without drying	Main rinse (55°C) Rinse 1+2 (55°C)	25	30	0.75	11

NOTE:



*EN 50242: this program is the test program and of combined energy and water consumption most efficient.

The information for comparability:

Capacity: 12 settings; Position of the upper basket: lower position; rinse aid setting: 6

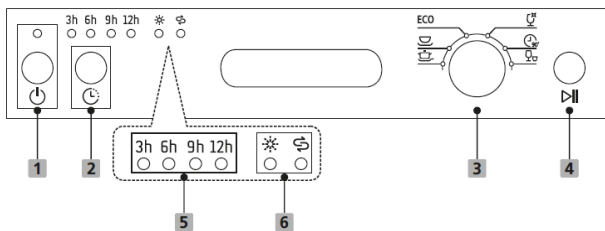
Control panel



- 1  Power: button to turn on/off the power supply. The control lamp indicates the power supply.
- 2  Delay: button to select the start delay of 3, 6, 9 or 12 hours. Press the Start/Pause button and the appliance starts automatically after the selected time delay has expired.
- 3 Program selector switch: To select a program, turn the program selector switch to the appropriate position. The program control lamps indicate the selection.
- 4  Start/Pause: button to start/pause the selected or running program.
- 5 The control lamps indicate the selection of the start delay.

- 6  Control lamp: lights up when rinse aid must be added.

 Control lamp: lights up, when dishwasher salt needs refilling.

Starting a program

- The water supply must be opened up to the maximum pressure.
- Load the dishwasher baskets.
- Fill in the detergent.
- Turn on the appliance.
- Set the required program options.
- Start the operation.

Changing a program

CAUTION:

A program change should be done only a short time after starting the program. Otherwise, maybe detergent has been released and already drained rinse water.

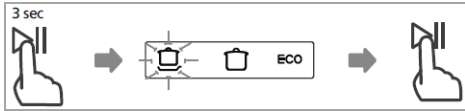

- To do a program change, press the Start/Pause button for more than 3 seconds.
- Select a new program and start the new operation.

Forgot to add a dish?

⚠ WARNING:

Open the door very carefully during operation, there is a risk of water squirting out.

Dishware can be added any time before the detergent dispenser opens.

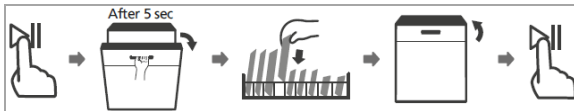

- Press the Start/Pause button to stop the operation. Once the spray arms have stopped, you can fully open the appliance door.
- Add forgotten dishware.
- Press the Start/Pause button, the operation will continue after approx. 10 seconds.

At the end of program

⚠ CAUTION:

Allow the appliance to cool down a bit after the program has ended, before you open it. This avoids that steam escapes that causing long-term damages to your furniture.

At the end of the rinse cycle will sound a series of signals; then the unit goes into standby mode.

Turn off

- Turn off the appliance.
- Close the water supply, if necessary!
- Remove the dishes after cooling (see "Unloading the dishwasher").
- Leave the appliance door slightly open until the next rinse cycle to avoid odors.

- If the appliance is not in use for an extended period, disconnect it from the power supply!

Unloading the dishwasher

⚠ CAUTION:

Let the dishware cool down for about 15 minutes before unloading. Hot dishes are sensitive to knocks.

ℹ NOTE:

At the end of program there could be still water drops inside the appliance.

- Open the appliance door and pull out the basket.
- To avoid water dripping from the upper basket onto the dishes in the lower basket, it is advisable to unload the appliance from the bottom up.

Energy saving tips

- Always try to operate the dishwasher when it is fully loaded.
- Do not rinse the dishes in advance under running water.
- Use for each type of load the most appropriate rinse program.
- Do not perform a pre-rinse (depending on model), if not absolutely necessary.

Cleaning and Maintenance

⚠ WARNING:

- Always turn off the appliance and disconnect it from the power supply before cleaning and user maintenance.
- Allow the appliance to cool down sufficient before cleaning.
- Do not use steam cleaners for cleaning the appliance; moisture could enter electrical components.
Risk of electric shock! Hot steam could damage the plastic parts. The appliance must be dry before restarting operation.

△ CAUTION:

- Do not use a wire brush or other sharp, abrasive items.
- Do not use any acidic or abrasive detergents.

i NOTE:

Dirty filters and clogged spray arms degrade the rinsing. Regularly check the filter and spray arms and clean them if necessary.

Filter system

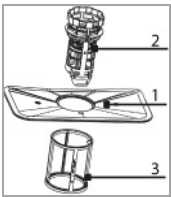

The three-part filter system prevents larger amounts of food or other objects from getting inside the pump.

- 1 Main filter:** food and soil particles trapped in this filter are pulverized by a special jet on the lower spray arm and washed down to drain.
- 2 Coarse filter:** filters out larger items such as pieces of bone or glass shards that could block the drainage.
- 3 Micro filter:** filters dirt and food residues in the sump area and prevents it from being redeposited on the dishware during rinse cycle.

Cleaning the filter system

△ CAUTION:

- The dishwasher must never be used without the filter.
- Improper replacement of the filter can reduce performance and damage the appliance.
- Do not knock out the filter for cleaning to avoid possible deformations of the filters.

i NOTE:

Check after each rinsing the filter for residues.

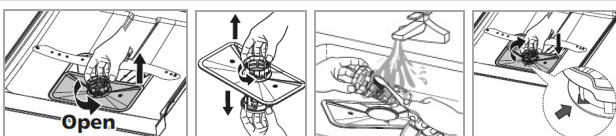

- Turn the coarse filter counterclockwise and remove the whole filter system upwards.

- Remove the coarse as well as the micro filter from the main filter.
- Remove leftover food and clean the filter under running water. Use a soft brush for the coarse and micro filter, if necessary.
- Put the filter system properly in reverse order together and reinstall in its provided position. Fix the entire system, by tightening the filter unit clockwise.

Cleaning the spray arms

Lime and impurities from the rinsing water can block nozzles and bearings of the spray arms. Check the outlet nozzles of the spray arms regularly for blockages.

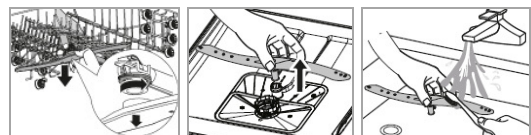

- Unscrew the securing nut of the upper spray and pull off the arm downwards.
- Pull off the lower spray arm upwards.
- Clean the arms under running water; if necessary use a soft brush for the nozzles.
- Insert the spray arms again until they clicks into place and tighten the nut of the upper spray arm.

Maintenance of the dishwasher

△ CAUTION:

Never use spray cleaners to clean the door panel, this may damage the door lock and electrical components.

- Clean the appliance outer surfaces and the door sealing thoroughly with a soft, damp cloth. Use only mild cleaning agent.
- Use to remove stains inside the appliance a dampened cloth with a little white vinegar or a special detergent for dishwashers. If necessary, fill detergent in and start the appliance without

dishware in the program with the highest rinse temperature.

- Dry the outer surfaces thoroughly before taking in operation again.

Antifreeze protection

If the unit is out of operation and exposed to temperatures below zero, observe the following precautions:

- Disconnect the mains plug.
- Close the water supply and remove the inlet hose from the water valve.
- Drain the water from the inlet hose and the water valve.
- Reconnect the inlet hose to the water valve.
- Turn off the lid of the salt container and take off the filter system. Remove the remaining water in the sump with an absorbent sponge.

Troubleshooting



Before you contact an authorized specialist

Problem	Possible cause / Action
Appliance is not working / starting	<ul style="list-style-type: none"> • Check the power supply. • Is the appliance turned on and the door securely closed? • Is a program selected? • Is the water supply properly connected and the water supply opened?
Water is not drained off	<ul style="list-style-type: none"> • Check the drain hose. • Are the filters or the kitchen sink clogged?
Noises	<ul style="list-style-type: none"> • A clicking sound on opening of the detergent container is normal. • Make sure that all dishes are secured in the dishwasher. • Place the parts so that the spray arms can rotate freely.
Foaming	<ul style="list-style-type: none"> • Use only special dishwasher detergent to avoid foaming. If this occurs, open the door and let suds evaporate. Add approx. 4 liter cold water to the tub. Start a short rinse cycle to drain out the water. • Always wipe up spilled rinse aid immediately.

Problem	Possible cause / Action
Flat tableware are not clean	<ul style="list-style-type: none"> • Select a stronger program. • Make sure that the action of the detergent dispenser and spray arm is not blocked by large dishes.
Spots and filming	<ul style="list-style-type: none"> • Extremely hard water • low inlet temperature • overloading the baskets, improper loading • old or damp detergent • empty rinse dispenser • incorrect dosage of detergent
Cloudiness glassware	Use less detergent if you have soft water and select a shortest cycle to rinse and clean glassware.
Black or grey marks	Aluminum utensils have rubbed against dishware. Use a mild abrasive cleaner to eliminate those marks.
Stains on inner surface	Only use detergents without colorants.
Yellow or brown film on inside surface	<ul style="list-style-type: none"> • Tea or coffee stains: Using a solution of ½ cup of bleach and 3 cups of warm water to remove the stains by hand. • Iron deposits in water can cause an overall film. Call a water softener company for a special filter.
White film on inside surface	Hard water minerals: clean the interior by using a damp sponge with dishwasher detergent. Wear rubber gloves.
Dispenser doesn't close properly	Clogged detergent residue is blocking the catch. Clean the catch.
Detergent left in dispenser	Improper loaded dish is blocking the dispenser.
Unsatisfactory drying result	<ul style="list-style-type: none"> • Improper loading • too less rinse aid • dishes are removed too soon • wrong program has been selected • use of cutlery with a low-quality coating

Error codes

For some malfunctions, the device displays the following error codes to warn you:

Control lamps flashes		Meaning / possible cause
 Rapid		Water inlet fault! Faucet not open, inlet blocked or water pressure too low.
 Rapid + 90 Min.		Not reaching required temperature! Malfunction of heating element.
 Glass		Overflow / water leakage!

⚠ CAUTION:

- If overflow occurs, turn off the main water supply before calling an authorized technician.
- If there is water in the lower housing part due to an overflowing or a small leak, remove this water before restarting the appliance.

ℹ NOTE:

If a problem still persists after following the steps above, please contact your distributor or an authorized technician.

Technical Data

Electrical connection / Water supply.....

Connection voltage:220-240 V~ / 50 Hz

Connection power:1760 – 2100 W

Water pressure:0.04 – 1 Mpa

Dimension H x W x D / Weight.....

Unit size:84.5 x 59.8 x 61.0 cm

Net weight:ca. 41.5 kg

Available accessory.....

Inlet hose safety system:Art.-No. 8900 400

The right to make technical and design modifications in the course of continuous product development remains reserved.

This appliance has been tested according to all relevant current CE guidelines, such as electromagnetic compatibility and low voltage directives, and has

been constructed in accordance with the latest safety regulations.



Disposal

Meaning of the “Dustbin” Symbol

Protect our environment; do not dispose of electrical equipment in the domestic waste.

Please return any electrical equipment that you will no longer use to the collection points provided for their disposal.

This helps avoid the potential effects of incorrect disposal on the environment and human health.

This will contribute to the recycling and other forms of reutilization of electrical and electronic equipment.

Information concerning where these can be disposed of can be obtained from your local authority.

⚠ WARNING:

Remove or disable any existing snap and bolt locks, if you take the unit out of operation or dispose it.

EU Product Data Sheet

Product information for household dishwasher according to regulation (EU) No. 1059/2010

Brand		BOMANN
Model		GSP 862
Standard place settings		12
Energy efficiency class ¹⁾		A++
Annual energy consumption ²⁾	kWh	258
Energy consumption of the standard cleaning cycle	kWh	0.91
Power consumption of the off mode	W	0.45
Power consumption of the left-on mode	W	0.49
Weighted annual water consumption ³⁾	l	3080
Drying efficiency class ⁴⁾		A
Standard program, information relates to the label and the data sheet ⁵⁾		ECO 45°C
Program duration of the standard cleaning cycle	Min	190
Duration of the left-on mode	Min	-
Noise emission	dB(A) re1pW	49
Built-in appliance		-

1) A+++ (highest efficiency) to D (lowest efficiency).

2) Based on 280 standard cleaning cycles using cold water fill and the consumption of the low power models. Actual energy consumption will depend on how the appliance is used.

3) Based on 280 standard cleaning cycles. Actual water consumption will depend on how the appliance is used.

4) A (highest efficiency) to G (lowest efficiency).

5) This program is suitable for cleaning normally soiled tableware and that it is the most efficient program in terms of its combined energy and water consumption for that type of tableware.

Note: The above values have been measured in accordance with standards under specified operating conditions. Results may vary greatly according to quantity and pollution of the dishes, water hardness, amount of detergent, etc.

BOMANN®
C. Bomann GmbH
www.bomann-germany.de
Made in P.R.C.

Stand 04/18