



# Samsung Optical Disc Drive

[Home](#)   [Index](#)

[Safety precautions](#)   [Features](#)   [How to install](#)   [How to use](#)   [How to store and clean](#)   [Troubleshooting](#)   [Specifications](#)



Samsung's OMS (Optical Media Solution) Customer Support Website ([www.samsung-ODD.com](http://www.samsung-ODD.com)) offers the latest versions of firmware for ODD products, user instructions and product information.



### Related links

<http://www.samsung-ODD.com>

<http://www.samsung.com>

### Select model

SH-222AB

### Select language

Select your language

### Firmware Update

Check your firmware version.

### Warranty Statement

Warranty statement for your product



## Safety precaution

## Safety precautions

## Safety precautions

## During installation

## During operation

## Others

## RoHS and WEEE

## Related links

<http://www.samsung-ODD.com>

<http://www.samsung.com>

## Select model

SH-222AB

## Select language

Select your language

## Firmware Update

Check your firmware version.

## Warranty Statement

Warranty statement for your product

## Important to read and understand at all times

	<b>Warning</b>	This symbol indicates an extremely dangerous situation. If users ignore this symbol and handle the device with the wrong way, serious injury or death could result.
	<b>Caution</b>	This symbol indicates that a dangerous situation might occur. If users ignore this symbol and handle the device with the wrong way, serious damage to the product could result.
	<b>Important</b>	Important to read and understand at all times.
	<b>Caution</b>	Do not disassemble.
	<b>Note</b>	Note

**Important**

IF A SOFTWARE PROGRAM IS TO BE BUNDLED WITH THE OPTICAL DISC DRIVE PROVIDED BY SAMSUNG, THEN YOU MUST HAVE A SEPARATE, VALID LICENSE FOR SUCH BUNDLED SOFTWARE WITH RESPECT TO THE MANUFACTURE, SALE OR DISTRIBUTION OF THE PRODUCT (SUCH AS A PERSONAL COMPUTER) CONTAINING THE OPTICAL DISC DRIVE AND THE BUNDLED SOFTWARE AS ITS COMPONENTS. OTHER THAN THOSE THIRD PARTY LICENSES EXPRESSLY STATED TO BE INCLUDED, SAMSUNG PROVIDES NO OTHER THIRD PARTY LICENSES, AND HEREBY DISCLAIMS ANY AND ALL LIABILITY WITH RESPECT THERETO.

Tc



## Safety precaution

## During Installation

## Safety precautions

## During installation

## During operation

## Others

## RoHS and WEEE

## Related links

<http://www.samsung-ODD.com>

<http://www.samsung.com>

## Select model

SH-222AB

## Select language

Select your language

## Firmware Update

Check your firmware version.

## Warranty Statement

Warranty statement for your product

## Installation

Do not install the drive on the unstable surface.

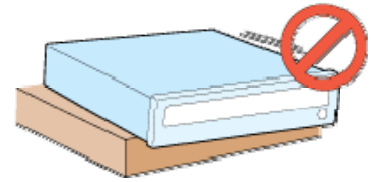

Do not place the drive in direct sunlight.

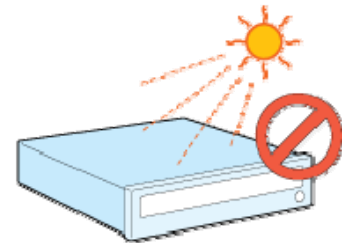

Avoid very low or high temperatures.

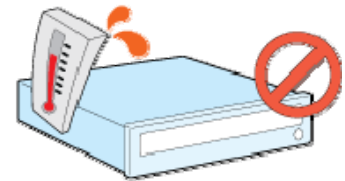

Avoid high humidity.

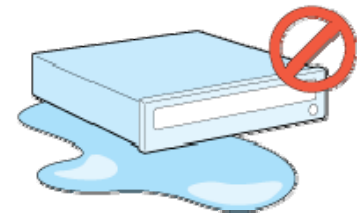

Tc



## Safety precaution

## During Operation

## Safety precautions

## During installation

## During operation

## Others

## RoHS and WEEE

## Related links

<http://www.samsung-ODD.com>

<http://www.samsung.com>

## Select model

SH-222AB

## Select language

Select your language

## Firmware Update

Check your firmware version.

## Warranty Statement

Warranty statement for your product

## Operation

Handle the drive carefully to prevent damage from an external shock.

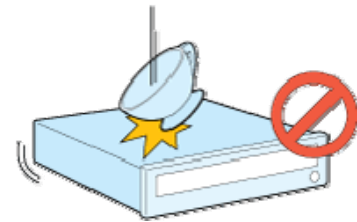

Do not drop the drive. Protect the drive from severe shocks.

If you do not protect it, this can cause damage to the drive.

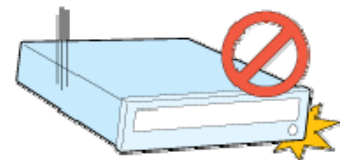

Do not move the drive or attempt to open the disc tray by force while it is in operation.

If you cannot open the tray using the Eject button, close all open applications and then open the tray by inserting a pin into the emergency hole.

Do not insert a pin into the emergency hole while the drive is in operation.

Keep your hand away from the tray while the drive is in operation.

This can result in damage to the product or human body.

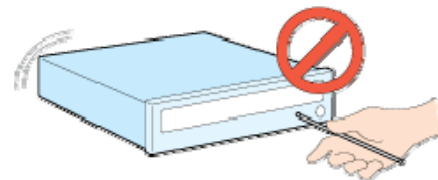

Do not use cracked, distorted or damaged discs.

A disc with a crack can break while you use it, especially when the crack is near the center of the disc.

Before you use the disc, always make sure that it does not have a crack. If the disc has a crack, we recommend you make a copy of the disc and use the copy. If you continue to use a cracked disc, the size of the crack will increase and this will cause irreparable damage to the disc.

Do not use low-quality discs (illegal, scratched, damaged, etc.).

**If you use such discs, Samsung is not responsible for the damage that this can cause.**

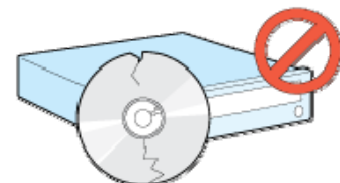

All Contents Copyright © 2001 - 2011

Tc

**SAMSUNG Electronics Co., Ltd. Optical Disc Drive**



## Safety precaution

### Safety precautions

#### During installation

#### During operation

#### Others

#### RoHS and WEEE

#### Related links

<http://www.samsung-ODD.com>

<http://www.samsung.com>

#### Select model

SH-222AB

#### Select language

Select your language

### Firmware Update

Check your firmware version.

### Warranty Statement

Warranty statement for your product

## Others

### Others

Make sure that no foreign material enters the drive casing.

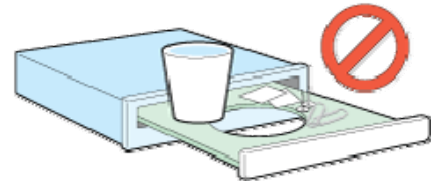

To protect against fire, do not use any flammable liquids such as alcohol or benzene on the drive.

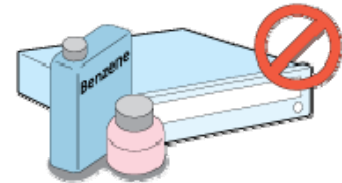

Do not disassemble, repair or modify the device without our approval.

To reduce the risk of damage, electric shock and fire.

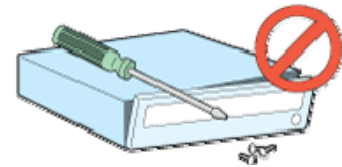

Tc



## Safety precaution

### Safety precautions

#### During installation

#### During operation

#### Others

### RoHS and WEEE

#### Related links

<http://www.samsung-ODD.com>

<http://www.samsung.com>

#### Select model

SH-222AB

#### Select language

Select your language

### Firmware Update

Check your firmware version.

### Warranty Statement

Warranty statement for your product

## RoHS and WEEE

### RoHS

#### Planet First logo

This logo shows consumers that Samsung develops eco-friendly products and demonstrates Samsung's continuous efforts to develop eco-friendly products.



#### RoHS(Restriction of the use of certain hazardous substances in electrical and electronic equipment)

The RoHS, the environmental regulation announced by European Union, restricts the use of lead, mercury, cadmium, hexavalent chromium, PBB, and PBDE in products put on the market in the European Union after July 1, 2006.

### WEEE

#### Correct Disposal of This Product (Waste Electrical & Electronic Equipment)

(Applicable in the European Union and other European countries with separate collection systems)



This marking on the product, accessories or literature indicates that the product and its electronic accessories (e.g. charger, headset, USB cable) should not be disposed of with other household waste at the end of their working life. To prevent possible harm to the environment or human health from uncontrolled waste disposal, separate these items from other types of waste and recycle them responsibly to promote the sustainable reuse of material resources.

Household users should contact either the retailer where they purchased this product, or their local government office, for details of where and how they can take this item for environmentally safe recycling.

Business users should contact their supplier and check the terms and conditions of the purchase contract. This product should not be mixed with other commercial waste for disposal.

To



## Features

### Exterior

#### System requirements

#### Recommended discs

#### Related links

<http://www.samsung-ODD.com>

<http://www.samsung.com>

#### Select model

SH-222AB

#### Select language

Select your language

### Firmware Update

Check your firmware version.

### Warranty Statement

Warranty statement for your product

## Exterior

### Front



1. Door tray
2. LED
3. Emergency hole
4. Eject button

#### Note

Design and specifications are subject to change without prior notice.

### Back

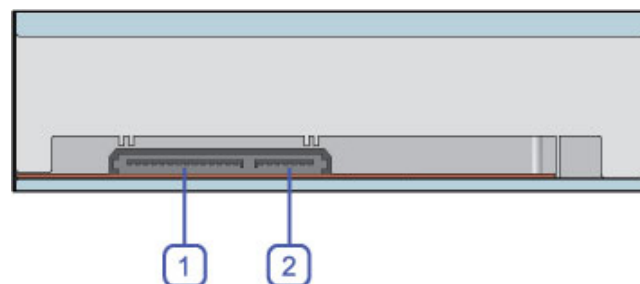

1. S-ATA power port
2. S-ATA data port

## Components

DVD writer

S-ATA data cable

Mounting screws

Quick installation guide

Application software & user manual CD

#### Note



All Contents Copyright © 2001 - 2011

**SAMSUNG Electronics Co., Ltd.**

If you need to return the purchased product, make sure to include all the accessories provided with the product to receive a refund.  
The type of accessories varies depending on a product model. Some accessories are subject to change without notice.

**Optical Disc Drive**

Tc



[Safety precautions](#)   [Features](#)   [How to install](#)   [How to use](#)   [How to store and clean](#)   [Troubleshooting](#)   [Specifications](#)

## Features

Exterior

System requirements

Recommended discs

### Related links

<http://www.samsung-ODD.com>

<http://www.samsung.com>

### Select model

SH-222AB

### Select language

Select your language

### Firmware Update

Check your firmware version.

### Warranty Statement

Warranty statement for your product

## System requirements

### System requirements

Item	Description
OS	Microsoft Windows 2000/XP/Vista/7
CPU	S-ATA supported PC (See our website for a list of compatible mainboards) Pentium4 2.0GHz or above
RAM	256 MB or more

Tr



## Features

[Exterior](#)

[System requirements](#)

[Recommended discs](#)

[Related links](#)

<http://www.samsung-ODD.com>

<http://www.samsung.com>

[Select model](#)

SH-222AB

[Select language](#)

Select your language

### Firmware Update

Check your firmware version.

### Warranty Statement

Warranty statement for your product

## Recommended discs

### Recommended DVD disc types

#### DVD-R Media

TAIYO-YUDEN, TDK, MKM(VERBATIM, MITSUBISHI), MAXELL, FUJIFILM, RITEK, CMC

#### DVD-RW Media

TDK, MKM(VERBATIM, MITSUBISHI), JVC, RITEK, CMC

#### DVD+R Media

RICOH, TAIYO-YUDEN, MKM(VERBATIM, MITSUBISHI), RITEK, CMC, PRODISC, OPTODISC

#### DVD+RW Media

RICOH, MKM(VERBATIM, MITSUBISHI), RITEK, CMC

#### DVD±R DL

MKM(VERBATIM, MITSUBISHI), RICOH

#### DVD-RAM

MAXELL, MKM(VERBATIM, MITSUBISHI)

[Top](#)

### Recommended CD disc types

#### CD-R Media

TAIYO-YUDEN, RICOH, MKM(VERBATIM, MITSUBISHI), MAXELL, FUJIFILM, RITEK (PHTHARO), CMC, PIONEER, PRINCO, TDK

#### CD-RW Media

RICOH, MKM(VERBATIM, MITSUBISHI), RITEK, CMC

#### HS CD-RW Media

RICOH, MKM(VERBATIM, MITSUBISHI), CMC

#### US CD-RW Media

MKM(VERBATIM, MITSUBISHI)

All Contents Copyright © 2001 - 2011

**SAMSUNG Electronics Co., Ltd. Optical Disc Drive**



## How to install

[How to install the drive](#)

[How to connect the cables](#)

[How to install the driver](#)

[How to update the Firmware](#)

### Related links

<http://www.samsung-ODD.com>

<http://www.samsung.com>

### Select model

SH-222AB

### Select language

Select your language

### Firmware Update

Check your firmware version.

### Warranty Statement

Warranty statement for your product

## How to install the drive

1. Turn off the PC.
2. Open the cover.  
See the pictures.

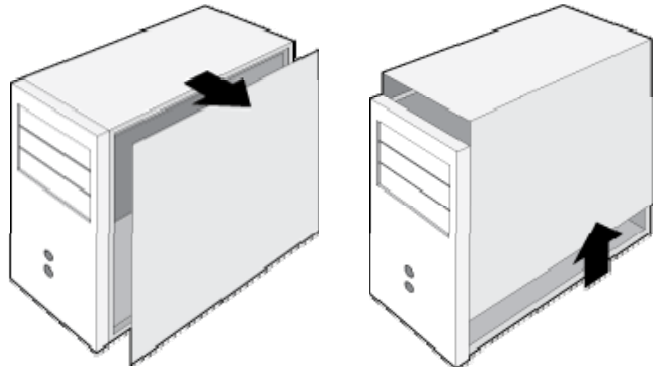

3. If necessary, attach the support devices on both sides of the drive.

The support devices are PC accessories. Purchase these items separately if necessary.  
(Screw: M3 x 6 x 4 )

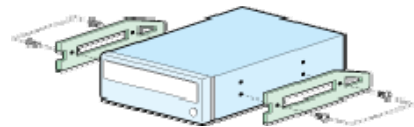

4. Remove the plate. Insert the drive.

Make sure to use the screws (M3 x 6) included with the drive.  
If you use other screws, this can cause damage.

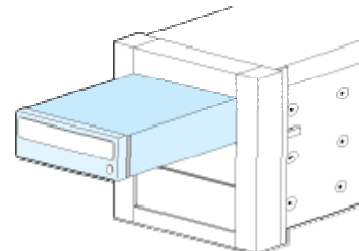

#### Caution

If the screws are not securely tightened, this can increase the noise level and cause vibrations.

Tc



## How to install

[How to install the drive](#)

[How to connect the cables](#)

[How to install the driver](#)

[How to update the Firmware](#)

### Related links

<http://www.samsung-ODD.com>

<http://www.samsung.com>

### Select model

SH-222AB

### Select language

Select your language

### Firmware Update

Check your firmware version.

### Warranty Statement

Warranty statement for your product

## How to connect the cables

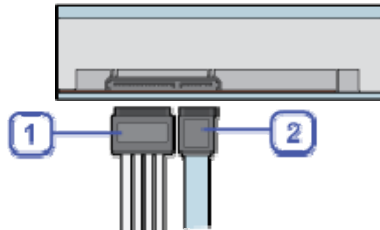

1. S-ATA power cable
2. S-ATA data cable

## How to connect the S-ATA cable

When you use one S-ATA drive

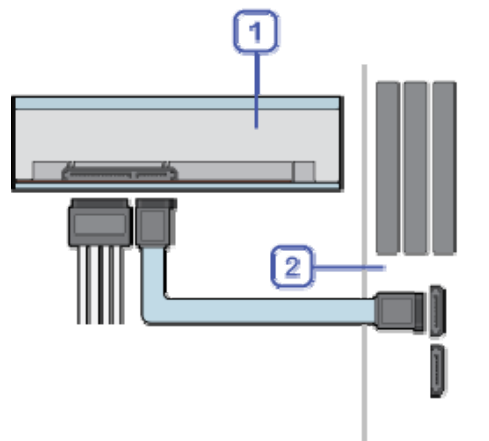

1. Drive
2. Mainboard

### Caution

If the screws are not securely tightened, this can increase the noise level and cause vibrations.

To



[Safety precautions](#)
[Features](#)
[How to install](#)
[How to use](#)
[How to store and clean](#)
[Troubleshooting](#)
[Specifications](#)

## How to install

[How to install the drive](#)

[How to connect the cables](#)

[How to install the driver](#)

[How to update the Firmware](#)

### Related links

<http://www.samsung-ODD.com>

<http://www.samsung.com>

### Select model

SH-222AB

### Select language

Select your language

### Firmware Update

Check your firmware version.

### Warranty Statement

Warranty statement for your product

## How to install the driver

### How to use the Device Manager

#### Windows 2000

1. Click **Start - Settings - Control Panel - System**.
2. Click on the **Hardware** tab in the **System Properties** window. Click on the **Device Manager** tab.
3. Click DVD-W drive in the **Device Manager** window.

Tc

#### Windows XP

1. Click **Start - Settings - Control Panel - Performance and Maintenance**.
2. Click the **Administrative Tools** icon in the **Performance and Maintenance** window.
3. Click the **Computer Management** icon in the **Administrative Tools** window.
4. Click **Device Manager** icon in the **Administrative Tools** window and then click DVD-W drive.

Tc

#### Windows Vista

1. Click **Start - Control Panel - System - Device Manager**.
2. Click DVD-W drive in the **Device Manager** window.

Tc

#### Windows 7

1. Click **Start - Control Panel - System and Security - System Device Manager**.
2. Click DVD-W drive in the **Device Manager** window.

Tc

[Safety precautions](#) [Features](#) [How to install](#) [How to use](#) [How to store and clean](#) [Troubleshooting](#) [Specifications](#)

## How to install

[How to install the drive](#)[How to connect the cables](#)[How to install the driver](#)[How to update the Firmware](#)

### Related links

<http://www.samsung-ODD.com><http://www.samsung.com>

### Select model

### Select language

### Firmware Update

Check your firmware version.

### Warranty Statement

Warranty statement for your product

## How to update the Firmware

1. Go to [www.samsung-ODD.com](http://www.samsung-ODD.com) .
2. Click **Firmware** on the menu bar (in the upper right corner).
3. Click **Firmware Downloads**. Find your drive model and start the download.

[Top](#)





## How to use

### How to use the drive

#### How to use DVD±R/RW and other discs

#### How to use MAGIC SPEED (Option)

#### When the LED blinks

#### Related links

<http://www.samsung-ODD.com>

<http://www.samsung.com>

#### Select model

SH-222AB

#### Select language

Select your language

#### Firmware Update

Check your firmware version.

#### Warranty Statement

Warranty statement for your product

## How to use the drive

### Caution

Do not turn off the PC or disconnect the drive while the green LED indicator blinks. This can cause damage to the drive.

### How to use a drive that is installed horizontally

You can use **3.15 inch or 4.72 inch (80 mm or 120 mm) discs**.

The drive can only read the disc correctly if the disc is placed inside the tray guiding line.

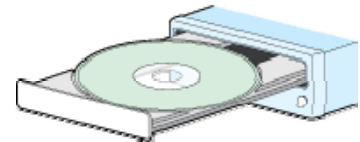

### How to use a drive that is installed vertically

You can install and use this drive vertically.

You can only use **4.72 inch (120 mm) discs**.

The drive can only read the disc correctly if the disc is placed inside the tray guiding line.

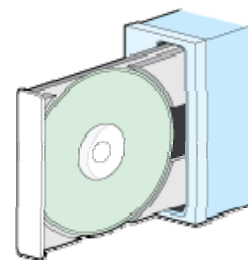

Tc



## How to use

### How to use the drive

#### How to use DVD±R/RW and other discs

#### How to use MAGIC SPEED (Option)

#### When the LED blinks

#### Related links

<http://www.samsung-ODD.com>

<http://www.samsung.com>

#### Select model

SH-222AB

#### Select language

Select your language

#### Firmware Update

Check your firmware version.

#### Warranty Statement

Warranty statement for your product

## How to use DVD±R/RW and other discs

### Important

The DVD Writer lets you write DVD±RW discs with Nero Express and enables "packet writing" (high-speed recording) with InCD.

The drive also lets you write DVD±R discs with Nero Express.

### Caution

***It is illegal to make unauthorized copies of DVD or software titles. A person who makes illegal copies can be held responsible for copyright infringement.***

***If you use low-quality discs, this can increase the recording time or make it impossible to use the disc.***

## How to use DVD±R/RW and other discs

After your computer recognizes the [CD-ROM] icon designated to the BD-ROM/DVD writer as the 'E:' drive, insert a CD-ROM or a DVD-ROM disc and make sure that the inserted disc is recognized.

(The assigned drive letter can be different in your specific system environment.)

You can use the drive to play commercial DVD titles:

Most DVD titles in the market use the Dolby sound system.

It is necessary to install software that supports Dolby decoding on your PC before you can play a DVD title with this drive.

How to get commercial software that supports Dolby decoding.

Go to the website of Nero: <http://www.nero.com>

(You can also use other compliant software)

## DVD Region Protection Coding (RPC)

### DVD Region Protection Coding (RPC):

The RPC feature is supported on DVD players and is used with DVD-video discs (such as movies). The motion picture industry has divided the world into different regions that correspond to the regional markets into which the motion picture industry releases movies. Movies worldwide have RPC codes, based on the region of the world in which they are being sold. These RPC codes help to control and prevent pirating of new movies into other motion picture regions before their release within those markets.

Therefore, this drive supports RPC phase II. In the RPC-2 mode, users can change the local code. RPC-2 is selected by default for this drive.

You can change the region code up to five times via an MPEG application.

Please contact your dealer or local SAMSUNG representative if you need to change the local code more than five times.

All Contents Copyright © 2001 - 2011 **SAMSUNG Electronics Co., Ltd. Optical Disc Drive**



## How to use

[How to use the drive](#)

[How to use DVD±R/RW and other discs](#)

[How to use MAGIC SPEED \(Option\)](#)

[When the LED blinks](#)

### Related links

<http://www.samsung-ODD.com>

<http://www.samsung.com>

### Select model

SH-222AB

### Select language

Select your language

### Firmware Update

Check your firmware version.

### Warranty Statement

Warranty statement for your product

## How to use MAGIC SPEED (Option)

### What is MAGIC SPEED?

**MAGIC SPEED** is a program that enables the user to select the reading speed of CD disc between two modes offered by the drive: **Maximum Speed Mode (Max Mode)** and **Silent Mode**.

#### Important

**MAGIC SPEED** may not be provided depending on the specifications.

### Development background

Modern ODD products offer a high reading speed.

With the increased reading speed, faster data processing has become possible. However, high rotation speed often causes more noise, and it is more probable that damaged discs crash. To remedy this backdrop, we have developed a **Speed-down** algorithm and applied this technology to newly-launched products to provide a safer and more comfortable environment.

#### What is the Speed-down Algorithm?

The Speed-down Algorithm operates the device at a safer disc reading speed. This prevents possible disc crashes when the disc has cracks. For customers who want to play CDs at maximum speed, **MAGIC SPEED** lets customers choose the reading speed. (The writing speed will not be limited)

Tc

### What is MAGIC SPEED and how to use it?

#### MAGIC SPEED mode

**Max Mode:** Set the reading speed to the maximum level for the drive.

**Silent Mode:** Set the reading speed to a stable low speed.

When the PC restarts, all modes set by **MAGIC SPEED** will be reset to low noise mode.

If you want to use the maximum speed mode, change the settings as necessary.

#### Caution

A disc with a crack can crash when you operate it in **Max Mode**. We recommend that you use this type of disc in **Silent Mode** and make a copy of the disc to use.

#### How to use MAGIC SPEED

1. Get the **MAGIC SPEED** program from our website. Then install it on your computer.

All Contents Copyright © 2001 - 2011

**SAMSUNG Electronics Co., Ltd.**

**Optical Disc Drive**

2. Right-click the **MAGIC SPEED** tray icon to start the program.
3. Select the desired mode and select **Settings**.
4. If the reading speed of the drive will be in the selected mode, select **Close** to exit.  
The reading speed will be active until it is changed or the program stops.

#### Note

We recommend you to use **Max Mode** for data copy or disc copy, and **Silent Mode** for normal operation.

Other functions

#### To disable Auto-Run

This is a default feature that automatically runs when the PC starts.

If you want to disable the auto-run feature, deselect the auto-run option in the tray icon menu.

Where can I download MAGIC SPEED?

Visit our website ([www.samsung-ODD.com](http://www.samsung-ODD.com) ) for customer support, and select **Firmware** > **MAGIC SPEED**.

Tc

## Buffer underrun free technology

**What is "buffer underrun prevention technology"?**

A technology to prevent "buffer underrun" errors in which the data transmission speed is not as fast as the data writing speed when you record data.

Tc



[Safety precautions](#)
[Features](#)
[How to install](#)
[How to use](#)
[How to store and clean](#)
[Troubleshooting](#)
[Specifications](#)

## How to use

### How to use the drive

[How to use DVD±R/RW and other discs](#)

[How to use MAGIC SPEED \(Option\)](#)

### When the LED blinks

#### Related links

<http://www.samsung-ODD.com>

<http://www.samsung.com>

#### Select model

SH-222AB

#### Select language

Select your language

#### Firmware Update

Check your firmware version.

#### Warranty Statement

Warranty statement for your product

## When the LED blinks

Status	LED
Disc Lead-In	Green: Blinks every 0.3 seconds.
Writing	Green: Blinks every 0.3 seconds.
Reading	Green: Blinks every 0.3 seconds.
Standby	Off
No Disc	Off

#### Note

The indicator light goes off when the drive is not in use (standby) after disc lead-in.

To



[Safety precautions](#)
[Features](#)
[How to install](#)
[How to use](#)
[How to store and clean](#)
[Troubleshooting](#)
[Specifications](#)

## How to store and clean

[How to clean the drive](#)

[How to store discs](#)

[How to clean discs](#)

### Related links

<http://www.samsung-ODD.com>

<http://www.samsung.com>

### Select model

SH-222AB

### Select language

Select your language

### Firmware Update

Check your firmware version.

### Warranty Statement

Warranty statement for your product

## How to clean the drive

1. Turn off the PC and remove the drive from the PC.
2. Use a soft cloth to remove any foreign matter from the surface of the drive.

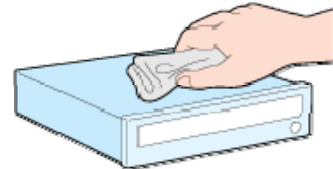

### Caution

Do not use benzene, paint thinner or other solvents.

Do not use cotton swabs or similar items to clean the interior of the unit. This can cause damage to the unit.

To



## How to store and clean

[How to clean the drive](#)

[How to store discs](#)

[How to clean discs](#)

### Related links

<http://www.samsung-ODD.com>

<http://www.samsung.com>

### Select model

SH-222AB

### Select language

Select your language

### Firmware Update

Check your firmware version.

### Warranty Statement

Warranty statement for your product

## How to store discs

### Important

This part of the manual gives information to prevent damage or data loss.  
Read carefully and use the device correctly.

Do not place it in direct sunlight.

Store discs so that they are lying face down on a flat surface.

Do not scratch the disc or put a label on it.

Handle the disc carefully to prevent damage from an external shock.

Do not expose it to large temperature changes.

(Exposure to such environment can cause congealing.)

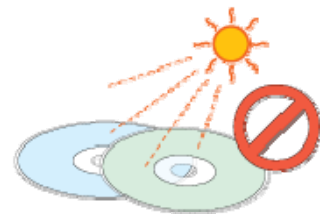

Tc





## How to store and clean

[How to clean the drive](#)

[How to store discs](#)

[How to clean discs](#)

### Related links

<http://www.samsung-ODD.com>

<http://www.samsung.com>

### Select model

SH-222AB

### Select language

Select your language

### Firmware Update

Check your firmware version.

### Warranty Statement

Warranty statement for your product

## How to clean discs

### Important

This part of the manual gives information to prevent damage or data loss.  
Read carefully and use the device correctly.

Do not touch the surface of the disc.

Put your fingers on the edge of the disc to hold it.

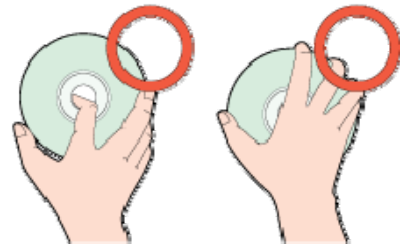

Use a soft cotton cloth to clean the disc. Start from the center and move to the edge of the disc.

Use only disc-cleaning liquids. Do not use benzene, paint thinner or other solvents.

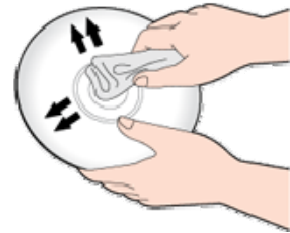

### Note

If the disc surface becomes dirty with fingerprints, foreign substances or dust, the disc will not function properly.

Tc



## Troubleshooting

## Troubleshooting

### Troubleshooting

Caution: possible errors

#### Related links

<http://www.samsung-ODD.com>

<http://www.samsung.com>

#### Select model

SH-222AB

#### Select language

Select your language

#### Firmware Update

Check your firmware version.

#### Warranty Statement

Warranty statement for your product

### General problems

Problem	Meaning / Solution
The tray does not open.	Make sure that the PC is on.
	Make sure that the power cable within the PC is connected correctly.
	If the tray still does not open when the power is on, switch off the power and insert a pin (paper clip) into the emergency hole.
The tray does not close.	Make sure that the disc is inserted correctly.
The system does not read the disc.	Make sure that the system detects the drive.
	Make sure that you use a disc type that is supported by the drive.
	Make sure that the LED indicator becomes green.
	Make sure that you inserted the disc with the label facing up.
	Make sure that you use the correct program to play the disc.
	Make sure that the disc is clean.
	Examine the drive for congealing.
Make sure that the region code of the drive matches the region code of the disc.	

See Help on our website and the User Manual provided by NERO with regard to the use of recording software.

Address: [www.samsung-ODD.com](http://www.samsung-ODD.com)

See **SUPPORT** > **Download Center** > **User Manual**.

See **INFORMATION** > **Flash Manual** > **Recording Software**.

To



## Troubleshooting

### Troubleshooting

#### Caution: possible errors

#### Related links

<http://www.samsung-ODD.com>

<http://www.samsung.com>

#### Select model

SH-222AB

#### Select language

Select your language

#### Firmware Update

Check your firmware version.

#### Warranty Statement

Warranty statement for your product

## Caution: Possible errors

The drive uses laser light to write data onto the surface of the disc. Writing errors can occur if you use a damaged disc. Make sure to prevent the conditions below before you start to write a disc.

#### Note

These settings are recommended for all drives.

- Do not use multitasking. Disable the screen saver.
 

A buffer under-run can occur if the system uses multitasking while the drive writes data.
- Do not let any outside computer access the host PC while the drive writes data.
 

An error can occur if another user accesses a network printer while the drive writes data.
- Disable the CD auto-run feature on all drives.
 

If you insert an auto-run CD into another drive within the same system while the drive writes data, this can cause an error.
- It is recommended that you use the image file format when you write a large number of small-sized files.
 

When there are many small files to write, the transfer rate decreases and the Buffer underrun protection feature works at a more frequent rate. This causes a lower writing quality.

If you are doing a CD-to-CD copy, it is not necessary to verify if you have available space on your hard disc.

However, in the case of image files, we recommend that you make sure you to have at least two times the amount of space needed for the data on your hard disc. This is because image files are copied to the hard disc before they are copied to the media.
- Use a regulation-length (50 cm) or shorter S-ATA cable.
 

If you use an S-ATA cable longer than 50 cm, this can cause a transmission error.
- Do not use more than one type of writing software.
 

Before you install a writing program, make sure to first uninstall existing versions of the program or other writing programs. After you uninstall any software, restart the PC. (The Windows operating system can be damaged if you install different language versions)

#### Note

We recommend that you use the data recording software provided by Samsung. If you use other recording software, this can cause an error.

All Contents Copyright © 2001 - 2011

**SAMSUNG Electronics Co., Ltd.**

### **Optical Disc Drive**

The write speed for a disc can be restricted if:

1. **The disc has bad properties, or there are other discs with bad properties under the same ID.**

The drive examines the disc properties to determine the best write conditions for the type of disc. Because the two types of disc have the same property data but different properties, it is often not possible to use the same settings. It is necessary to decrease the writing speed to make the writing more stable.

If discs from two different disc makers have the same writing speed according to the labels, but actually have different writing speeds, it is necessary to reduce the writing speed.

2. **Samsung standards to decrease writing speed**

**Standard 1:** If there are high-speed discs in the market that have very bad property data, the writing speed is decreased. This also happens if there are low-speed discs with the same ID.

**Standard 2:** Discs for which the speed was reduced, will be examined again. If low-speed discs are no longer available in the market under the same ID as a high-speed disc, the decreased writing speed will no longer apply to the high-speed disc.

#### **Note**

It is possible that you do not get good writing quality with discs from manufacturers that are not registered in the drive's firmware.

We thus recommend that you only use discs from recommended companies.

Always make sure that the writing was successful before you put the disc in storage. This is very important when you want to store important data.

(Samsung is not responsible for any loss caused by a backup failure)

#### **Note**

We update the list of supported media on a regular basis and make them available in our firmware upgrades.

Tc



## Specifications

## Product specifications

## Product specifications

## Related links

<http://www.samsung-ODD.com>
<http://www.samsung.com>

## Select model

SH-222AB

## Select language

Select your language

## Firmware Update

Check your firmware version.

## Warranty Statement

Warranty statement for your product

## Specifications

Category		SH-222AB	
		DVD writer	
Disc	Usable discs	<b>DVD:</b> DVD-R, DVD-RW, DVD+R, DVD+RW, DVD-ROM, DVD-Video, DVD+R DL, DVD-R DL, DVD-RAM <b>CD:</b> CD-ROM, CD-R, CD-RW, CD-DA, CD+E(G), CD-MIDI, CD-TEXT, CD-ROM XA, Mixed Mode CD, CD-I, CD-I Bridge (Photo-CD, Video-CD), Multisession CD (Photo-CD, CD-EXTRA, Portfolio)	
	Disc diameter	3.15 inch or 4.72 inch (80 mm or 120 mm)	
Interface support	Interface port	S-ATA	
	Burst Transfer Rate	S-ATA 1.5 Gbps	
Access time (random)	CD-ROM	130 ms	
	DVD-ROM	150 ms	
Data transfer speed (max)	<b>Media type</b>	<b>Write</b>	<b>Read</b>
	DVD+R	CAV 22X	CAV 16X
	DVD+RW	ZCLV 8X	CAV 12X
	DVD+R DL	CAV 16X	CAV 12X
	DVD-R DL	CAV 12X	CAV 12X
	DVD-R	CAV 22X	CAV 16X
	DVD-RW	CLV 6X	CAV 12X
	DVD-ROM	-	CAV 16X
	DVD-ROM DL	-	CAV 12X

All Contents Copyright © 2001 - 2011

SAMSUNG Electronics Co., Ltd.

Optical Disc Drive

Category		SH-222AB	
		DVD writer	
	DVD-RAM	PCAV 12X	PCAV 12X
	CD-ROM	-	CAV 48X
	CD-R	PCAV 48X	CAV 40X
	US-RW	ZCLV 24X	CAV 40X
	HS-RW	CLV 10X	CAV 40X
	CD-RW	CLV 4X	CAV 40X
<b>Buffer memory</b>		1.5 MB	
<b>Drive installation</b>		Horizontal / Vertical	
<b>Operating environment</b>	Temperature	41 °F ~ 122 °F (5 °C ~ 50 °C)	
	Humidity	20% ~ 80% (RH)	
<b>Dimensions (width x height x length)</b>		5.83 x 1.65 x 6.69 inch (148.2 x 42 x 170 mm)	
<b>Weight</b>		750 g	

**Note**

Does not support DVD-R for Authoring.

Cannot playback or record on both sides of a dual layer disc simultaneously.

Because the read/write capacity of the supported discs depends on the condition of the disc and the recording format of the drive, the read/write quality may not be perfect.

Firmly install the product into the PC before use.

Specifications are subject to change without notice.

Tc

**FCC information to the user**

This equipment has been tested and found to comply with the limits for a Class B digital device, pursuant to Part 15 of the FCC Rules. These limits are designed to provide reasonable protection against harmful interference in a residential installation.

This equipment generates, uses and can radiate radio frequency energy and, if not installed and used in accordance with the instructions, may cause harmful interference to radio communications.

However, there is no guarantee that interference will not occur in a particular installation.

If this equipment does cause harmful interference to radio or television reception, which can be determined by turning the equipment off and on, the user is encouraged to try to correct the interference by one or more of the following measures:

Reorient or relocate the receiving antenna.

Increase the separation between the equipment and receiver.

Connect the equipment into an outlet on a circuit different from that to which the receiver is connected.

Consult the dealer or an experienced radio/TV technician for help.

**Caution**

Change or modifications not expressly approved by the manufacturer responsible for compliance could void the user's authority to operate the equipment.

Tc

## Laser Standard

EN 60825-1 :2007

**Important**

***The product specifications above may be changed to improve device performance without prior notice.***

Tc



[Safety precautions](#) [Features](#) [How to install](#) [How to use](#) [How to store and clean](#) [Troubleshooting](#) [Specifications](#)

## Index

### Related links

<http://www.samsung-ODD.com>

<http://www.samsung.com>

### Select model

SH-222AB

### Select language

Select your language

### Firmware Update

Check your firmware version.

### Warranty Statement

Warranty statement for your product

## Index

### Safety precautions

[Safety precautions](#)  
[During installation](#)  
[During operation](#)  
[Others](#)  
[RoHS and WEEE](#)

### Features

[Exterior](#)  
[System requirements](#)  
[Recommended discs](#)

### How to install

[How to install the drive](#)  
[How to connect the cables](#)  
[How to install the driver](#)  
[How to update the Firmware](#)

### How to use

[How to use the drive](#)  
[How to use DVD±R/RW and other discs](#)  
[How to use MAGIC SPEED \(Option\)](#)  
[When the LED blinks](#)

### How to store and clean

[How to clean the drive](#)  
[How to store discs](#)  
[How to clean discs](#)

### Troubleshooting

[Troubleshooting](#)  
[Caution: possible errors](#)

### Specifications

[Product specifications](#)



All Contents Copyright © 2001 - 2011 **SAMSUNG Electronics Co., Ltd. Optical Disc Drive**