

# User's Guide

---

## Samsung Printer *Xpress*

M267x series

M287x series

M288x series

### **BASIC**

This guide provides information concerning installation, basic operation and troubleshooting on Windows.

### **ADVANCED**

This guide provides information about installation, advanced configuration, operation and troubleshooting on various OS environments.

Some features may not be available depending on models or countries.



## 1. Introduction

Key benefits	5
Features by model	7
Useful to know	13
About this user's guide	14
Safety information	15
Machine overview	21
Control panel overview	24
Turning on the machine	28
Installing the driver locally	29
Reinstalling the driver	31



## 2. Menu Overview and Basic Setup

Menu overview	33
Machine's basic settings	37
Media and tray	39
Basic printing	54
Basic copying	60
Basic scanning	65
Basic faxing	66



## 3. Maintenance

Ordering supplies and accessories	71
Available supplies	72
Available maintenance parts	73
Storing the toner cartridge	74
Redistributing toner	76
Replacing the toner cartridge	79
Replacing the imaging unit	82
Monitoring the supplies life	84
Setting the toner low alert	85
Cleaning the machine	86
Tips for moving & storing your machine	93



## 4. Troubleshooting

Tips for avoiding paper jams	95
Clearing original document jams	96
Clearing paper jams	99
Understanding the status LED	107
Understanding display messages	110



## 5. Appendix

<b>Specifications</b>	<b>116</b>
<b>Regulatory information</b>	<b>126</b>
<b>Copyright</b>	<b>139</b>



# 1. Introduction

This chapter provides information you need to know before using the machine.

- **Key benefits** 5
- **Features by model** 7
- **Useful to know** 13
- **About this user's guide** 14
- **Safety information** 15
- **Machine overview** 21
- **Control panel overview** 24
- **Turning on the machine** 28
- **Installing the driver locally** 29
- **Reinstalling the driver** 31

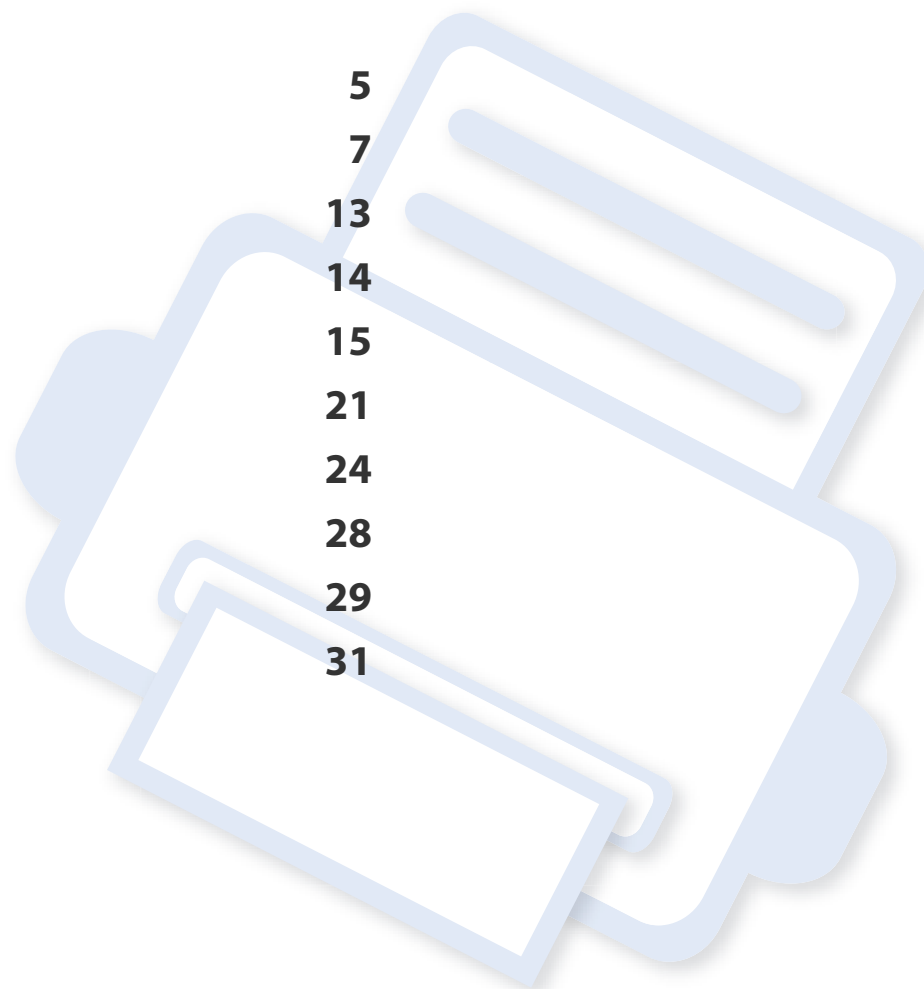

# Key benefits

## Environmentally friendly



- To save toner and paper, this machine supports Eco feature.
- To save paper, you can print multiple pages on one single sheet of paper (see "Using advanced print features" on page 232).
- To save paper, you can print on both sides of the paper (double-sided printing) (see "Using advanced print features" on page 232).
- To save electricity, this machine automatically conserves electricity by substantially reducing power consumption when not in use.
- We recommend using recycled paper for saving energy.

## Fast high resolution printing



- You can print with a resolution of up to 4,800 x 600 dpi effective (600 x 600 x 3 bit) output.
- Fast, on-demand printing.  
M267x series:
  - For single-side printing, up to 26 ppm (A4) or up to 27 ppm (Letter).M287x/M288x series:
  - For single-side printing, up to 28 ppm (A4) or up to 29 ppm (Letter).

## Convenience



- Simply touch your mobile device on the NFC tag on your printer and get the print job done (see "Using the NFC feature" on page 197).
- You can print on the go from your smartphone or computer using Google Cloud Print™ enabled apps (see "Google Cloud Print™" on page 205).
- Easy Capture Manager allows you to easily edit and print whatever you captured using the Print Screen key on the keyboard (see "Easy Capture Manager" on page 263).

# Key benefits

- Samsung Easy Printer Manager and Printing Status is a program that monitors and informs you of the machine's status and allows you to customize the machine's settings (see "Using Samsung Printer Status" on page 273 or "Using Samsung Easy Printer Manager" on page 270).
- Samsung Easy Document Creator is an application to help users scan, compile, and save documents in multiple formats, including .epub format. These documents can be shared via social networking sites or fax (see "Using Samsung Easy Document Creator" on page 269).
- AnyWeb Print helps you screen-capture, preview, scrap, and print the screen of Windows Internet Explorer more easily than when you use the ordinary program (see "Samsung AnyWeb Print" on page 264).
- Smart Update allows you to check for the latest software and install the latest version during the printer driver installation process. This is available only for Windows.
- If you have Internet access, you can get help, support application, machine drivers, manuals, and order information from the Samsung website, [www.samsung.com](http://www.samsung.com) > find your product > Support or Downloads.

## Wide range of functionality and application support



- Supports various paper sizes (see "Print media specifications" on page 118).
- Print watermark: You can customize your documents with words, such as "Confidential" (see "Using advanced print features" on page 232).

- Print posters: The text and pictures of each page of your document are magnified and printed across the multiple sheets of paper and can then be taped together to form a poster (see "Using advanced print features" on page 232).
- You can print in various operating systems (see "System requirements" on page 121).
- Your machine is equipped with a USB interface and/or a network interface.

## Supports various wireless network setting method



- Using the WPS (Wi-Fi Protected Setup™) button
  - You can easily connect to a wireless network using the WPS button on the machine and the access point (a wireless router).
- Using the USB cable or a network cable
  - You can connect and set various wireless network settings using a USB cable or a network cable.
- Using the Wi-Fi Direct
  - You can conveniently print from your mobile device using the Wi-Fi or Wi-Fi Direct feature.



See "Introducing wireless set up methods" on page 166.

# Features by model

Some features and optional goods may not be available depending on model or country.

## Operating System

Operating System	M267x series	M287x series M288x series
Windows	•	•
Mac	•	•
Linux	•	•
Unix		•

(•: Included, Blank: Not available)

## Software

You can install the printer driver and software when you insert the software CD into your CD-ROM drive.

For Windows, select the printer driver and software in the **Select Software to Install** window.

Software	M267x series	M287x series M288x series
SPL printer driver <sup>a</sup>	•	•
PCL printer driver		•
PS printer driver <sup>a</sup>		

# Features by model

Software		M267x series	M287x series M288x series
XPS printer driver <sup>b</sup>		•	•
Direct Printing Utility <sup>b</sup>			
Samsung Easy Printer Manager	Scan to PC settings	•	•
	Fax to PC settings	• (M267xF/M267xFN/M267xFH/M267xHN only)	• (M287xFD/M287xFW/M287xHN/M288xFW/ M288xHW only)
	Device settings	•	•
Samsung Printer Status		•	•
Samsung AnyWeb Print <sup>b</sup>		•	•
Samsung Easy Document Creator		•	•
Easy Capture Manager		•	•
SyncThru™ Web Service		• (M267xN/M267xFN/M267xHN only)	•
SyncThru Admin Web Service		• (M267xN/M267xFN/M267xHN only)	•
Easy Eco Driver		•	•
Easy Capture Manager		•	•



# Features by model

Software		M267x series	M287x series M288x series
Fax	<b>Samsung Network PC Fax</b>	● (M267xF/M267xFN/ M267xFH/ M267xHN only)	● (M287xFD/M287xFW/M287xHN/M288xFW/ M288xHW only)
	<b>WIA scan driver</b>	●	●
Scan	<b>Twain scan driver</b>	●	●
	<b>WIA scan driver</b>	●	●

a. Depending on the operating system you use, the installed printer driver may differ.

b. Download the software from the Samsung website and install it: (<http://www.samsung.com> > find your product > Support or Download). Before installing, check whether your computer's OS support the software.

(●: Included, Blank: Not available)

# Features by model

## Variety feature

Features		M267x series	M287x series M288x series
Hi-Speed USB 2.0		•	•
Network Interface Ethernet 10/100 Base TX wired LAN		• (M267xN/M267xFN/M267xHN only)	•
Network Interface 802.11b/g/n wireless LAN <sup>a</sup>			• (M287xDW/M287xFW/M288xFW/M288xHW only)
NFC (Near Field Communication)			• (M288xFW/M288xHW only)
Google Cloud Print™		• (M267xN/M267xFN/M267xHN only)	•
AirPrint		• (M267xN/M267xFN/M267xHN only)	•
Eco printing		•	•
Duplex (2-sided) printing			•
Duplex (2-sided) printing (manual) <sup>bc</sup>		•	
Document Feeder	Automatic Document Feeder (ADF)	•	•

# Features by model

Features		M267x series	M287x series M288x series
<b>Handset</b>		<ul style="list-style-type: none"> <li>•</li> </ul> (M267xFH/M267x HN only)	<ul style="list-style-type: none"> <li>•</li> </ul> (M287x HN/M288xHW only)
<b>Fax</b>	<b>Multi Send</b>	<ul style="list-style-type: none"> <li>•</li> </ul> (M267xF/M267xFN/M267xFH/ M267xHN only)	<ul style="list-style-type: none"> <li>•</li> </ul> (M287xFD/M287xFW/M287xHN/M288xFW/ M288xHW only)
	<b>Delay Send</b>	<ul style="list-style-type: none"> <li>•</li> </ul> (M267xF/M267xFN/M267xFH/ M267xHN only)	<ul style="list-style-type: none"> <li>•</li> </ul> (M287xFD/M287xFW/M287xHN/M288xFW/ M288xHW only)
	<b>Priority Send</b>	<ul style="list-style-type: none"> <li>•</li> </ul> (M267xF/M267xFN/M267xFH/ M267xHN only)	<ul style="list-style-type: none"> <li>•</li> </ul> (M287xFD/M287xFW/M287xHN/M288xFW/ M288xHW only)
	<b>Forward to Fax</b>	<ul style="list-style-type: none"> <li>•</li> </ul> (M267xF/M267xFN/M267xFH/ M267xHN only)	<ul style="list-style-type: none"> <li>•</li> </ul> (M287xFD/M287xFW/M287xHN/M288xFW/ M288xHW only)
	<b>Secure Receive</b>	<ul style="list-style-type: none"> <li>•</li> </ul> (M267xF/M267xFN/M267xFH/ M267xHN only)	<ul style="list-style-type: none"> <li>•</li> </ul> (M287xFD/M287xFW/M287xHN/M288xFW/ M288xHW only)
<b>Scan</b>	<b>Scan to PC</b>	<ul style="list-style-type: none"> <li>•</li> </ul>	<ul style="list-style-type: none"> <li>•</li> </ul>

# Features by model

Features		M267x series	M287x series M288x series
<b>Copy</b>	<b>Duplex</b>		●
	<b>Reduce/Enlarge</b>	●	●
	<b>Collation</b>	●	●
	<b>2-up/ 4-up</b>	●	●
	<b>Adjust background</b>	●	●

a. Depending on your country, wireless LAN card may not be available. For some countries, only 802.11 b/g can be applied. Contact your local Samsung dealer or the retailer where you bought your machine.

b. Available for Windows OS only.

c. Only tray 1 is supported.

(●: Included, Blank: Not available)

# Useful to know



## The machine does not print.

- Open the print queue list and remove the document from the list (see "Canceling a print job" on page 56).
- Remove the driver and install it again (see "Installing the driver locally" on page 29).
- Select your machine as your default machine in your Windows.



## Where can I purchase accessories or supplies?

- Inquire at a Samsung distributor or your retailer.
- Visit [www.samsung.com/supplies](http://www.samsung.com/supplies). Select your country/region to view product service information.



## The status LED flashes or remains constantly on.

- Turn the product off and on again.
- Check the meanings of LED indications in this manual and troubleshoot accordingly (see "Understanding the status LED" on page 107).



## A paper jam has occurred.

- Open and close the front door.
- Check the instructions on removing jammed paper in this manual and troubleshoot accordingly (see "Clearing paper jams" on page 99).



## Printouts are blurry.

- The toner level might be low or uneven. Shake the toner cartridge.
- Try a different print resolution setting.
- Replace the toner cartridge.



## Where can I download the machine's driver?

- Visit [www.samsung.com](http://www.samsung.com) to download the latest machine's driver, and install it on your system.

# About this user's guide

This user's guide provides information for your basic understanding of the machine as well as detailed steps to explain machine usage.



- Do not discard this manual, and keep it for future reference.
- Read the safety information before using the machine.
- If you have a problem using the machine, refer to the troubleshooting chapter.
- Terms used in this user's guide are explained in the glossary chapter.
- All illustrations in this user's guide may differ from your machine depending on its options or model you purchased.
- The screenshots in this user's guide may differ from your machine depending on the machine's firmware/driver version.
- The procedures in this user's guide are mainly based on Windows 7.

## Conventions

Some terms in this guide are used interchangeably, as below:

- Document is synonymous with original.
- Paper is synonymous with media, or print media.
- Machine refers to printer or MFP.

## General icons



Icon	Text	Description
	<b>Caution</b>	Gives users information to protect the machine from possible mechanical damage or malfunction.
	<b>Warning</b>	Used to alert users to the possibility of personal injury.
	<b>Note</b>	Provides additional information or detailed specification of the machine function and feature.

# Safety information

These warnings and precautions are included to prevent injury to you and others, and to prevent any potential damage to your machine. Be sure to read and understand all of these instructions before using the machine. After reading this section, keep it in a safe place for future reference.





## Important safety symbols

### Explanation of all icons and signs used in this chapter

	<b>Warning</b>	Hazards or unsafe practices that may result in severe personal injury or death.
	<b>Caution</b>	Hazards or unsafe practices that may result in minor personal injury or property damage.
		Do not attempt.



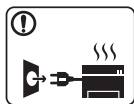
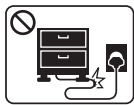



## Operating environment

### Warning

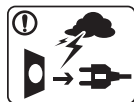
	<p>Do not use if the power cord is damaged or if the electrical outlet is not grounded.</p> <p>This could result in electric shock or fire.</p>
	<p>Do not place anything on top of the machine (water, small metal or heavy objects, candles, lit cigarettes, etc.).</p> <p>This could result in electric shock or fire.</p>
	<ul style="list-style-type: none"><li>• If the machine gets overheated, it releases smoke, makes strange noises, or generates an odd odor, immediately turn off the power switch and unplug the machine.</li><li>• The user should be able to access the power outlet in case of emergencies that might require the user to pull the plug out.</li></ul> <p>This could result in electric shock or fire.</p>
	<p>Do not bend, or place heavy objects on the power cord.</p> <p>Stepping on or allowing the power cord to be crushed by a heavy object could result in electric shock or fire.</p>
	<p>Do not remove the plug by pulling on the cord; do not handle the plug with wet hands.</p> <p>This could result in electric shock or fire.</p>







# Safety information

## Caution

	<p>During an electrical storm or for a period of non-operation, remove the power plug from the electrical outlet.</p> <p>This could result in electric shock or fire.</p>
	<p>Be careful, the paper output area is hot.</p> <p>Burns could occur.</p>
	<p>If the machine has been dropped, or if the cabinet appears damaged, unplug the machine from all interface connections and request assistance from qualified service personnel.</p> <p>Otherwise, this could result in electric shock or fire.</p>
	<p>If the machine does not operate properly after these instructions have been followed, unplug the machine from all interface connections and request assistance from qualified service personnel.</p> <p>Otherwise, this could result in electric shock or fire.</p>
	<p>If the plug does not easily enter the electrical outlet, do not attempt to force it in.</p> <p>Call an electrician to change the electrical outlet, or this could result in electric shock.</p>
	<p>Do not allow pets to chew on the AC power, telephone or PC interface cords.</p> <p>This could result in electric shock or fire and/or injury to your pet.</p>



## Operating method

### Caution

	<p>Do not forcefully pull the paper out during printing.</p> <p>It can cause damage to the machine.</p>
	<p>Be careful not to put your hand between the machine and paper tray.</p> <p>You may get injured.</p>
	<p>Be care when replacing paper or removing jammed paper.</p> <p>New paper has sharp edges and can cause painful cuts.</p>
	<p>When printing large quantities, the bottom part of the paper output area may get hot. Do not allow children to touch.</p> <p>Burns can occur.</p>
	<p>When removing jammed paper, do not use tweezers or sharp metal objects.</p> <p>It can damage the machine.</p>
	<p>Do not allow too many papers to stack up in the paper output tray.</p> <p>It can damage the machine.</p>



# Safety information



	Do not block or push objects into the ventilation opening. This could result in elevated component temperatures which can cause damage or fire.
	Use of controls or adjustments or performance of procedures other than those specified herein may result in hazardous radiation exposure.
	This machine's power reception device is the power cord. To switch off the power supply, remove the power cord from the electrical outlet.

## Installation / Moving

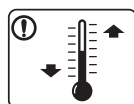



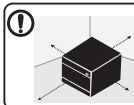

### Warning

	Do not place the machine in an area with dust, humidity, or water leaks. This could result in electric shock or fire.
	Place the machine in the environment where it meets the operating temperature and humidity specification. Otherwise, quality problems can occur and cause damage to the machine (see "General specifications" on page 116).

### Caution

	Before moving the machine, turn the power off and disconnect all cords. The information below are only suggestions based on the units weight.  If you have a medical condition that prevents you from lifting, do not lift the machine. Ask for help, and always use the appropriate amount of people to lift the device safely.  Then lift the machine: <ul style="list-style-type: none"><li>• If the machine weighs under 20 kg (44.09 lbs), lift with 1 person.</li><li>• If the machine weighs 20 kg (44.09 lbs) - 40kg (88.18 lbs), lift with 2 people.</li><li>• If the machine weighs more than 40 kg (88.18 lbs), lift with 4 or more people.</li></ul> The machine could fall, causing injury or machine damage.
	Choose a flat surface with enough space for ventilation to place the machine. Also consider the space required to open the cover and trays.  The place should be well-ventilated and be far from direct light, heat, and humidity.
	When using the machine for a long period of time or printing a large number of pages in a non-ventilated space, it could pollute the air and be harmful to your health. Place the machine in a well-ventilated space or open a window to circulate the air periodically.





# Safety information

	Do not place the machine on an unstable surface. The machine could fall, causing injury or machine damage.
	Use only No.26 AWG <sup>a</sup> or larger, telephone line cord, if necessary. Otherwise, it can cause damage to the machine.
	Make sure you plug the power cord into a grounded electrical outlet. Otherwise, this could result in electric shock or fire.
	Use the power cord supplied with your machine for safe operation. If you are using a cord which is longer than 2 meters (6 feet) with a 110V machine, then the gauge should be 16 AWG or larger. Otherwise, it can cause damage to the machine, and could result in electric shock or fire.
	Do not put a cover over the machine or place it in an airtight location, such as a closet. If the machine is not well-ventilated, this could result in fire.
	Do not overload wall outlets and extension cords. This can diminish performance, and could result in electric shock or fire.
	The machine should be connected to the power level which is specified on the label. If you are unsure and want to check the power level you are using, contact the electrical utility company.



a. AWG: American Wire Gauge

## Maintenance / Checking

### Caution

	Unplug this product from the wall outlet before cleaning the inside of the machine. Do not clean the machine with benzene, paint thinner or alcohol; do not spray water directly into the machine. This could result in electric shock or fire.
	When you are working inside the machine replacing supplies or cleaning the inside, do not operate the machine. You could get injured.
	Keep cleaning supplies away from children. Children could get hurt.
	Do not disassemble, repair or rebuild the machine by yourself. It can damage the machine. Call a certified technician when the machine needs repairing.





# Safety information

	<p>To clean and operate the machine, strictly follow the user's guide provided with the machine.</p> <p>Otherwise, you could damage the machine.</p>
	<p>Keep the power cable and the contact surface of the plug clean from dust or water.</p> <p>Otherwise, this could result in electric shock or fire.</p>
	<ul style="list-style-type: none"><li>• Do not remove any covers or guards that are fastened with screws.</li><li>• Fuser units should only be repaired by a certified service technician. Repair by non-certified technicians could result in fire or electric shock.</li><li>• The machine should only be repaired by a Samsung service technician.</li></ul>

## Supply usage

### Caution

	<p>Do not disassemble the toner cartridge.</p> <p>Toner dust can be dangerous if inhaled or ingested.</p>
--	---

	<p>Do not burn any of the supplies such as toner cartridge or fuser unit.</p> <p>This could cause an explosion or uncontrollable fire.</p>
	<p>When storing supplies such as toner cartridges, keep them away from children.</p> <p>Toner dust can be dangerous if inhaled or ingested.</p>
	<p>Using recycled supplies, such as toner, can cause damage to the machine.</p> <p>In case of damage due to the use of recycled supplies, a service fee will be charged.</p>
	<p>For supplies that contain toner dust (toner cartridge, waste toner bottle, imaging unit, etc.) follow the instructions below.</p> <ul style="list-style-type: none"><li>• When disposing of the supplies, follow the instructions for disposal. Refer to the reseller for disposal instructions.</li><li>• Do not wash the supplies.</li><li>• For a waste toner bottle, do not reuse it after emptying the bottle.</li></ul> <p>If you do not follow the instructions above, it may cause machine malfunction and environmental pollution. The warranty does not cover damages caused by a user's carelessness.</p>
	<p>When toner gets on your clothing, do not use hot water to wash it.</p> <p>Hot water sets toner into fabric. Use cold water.</p>

# Safety information



When changing the toner cartridge or removing jammed paper, be careful not to let toner dust touch your body or clothes.

Toner dust can be dangerous if inhaled or ingested.

# Machine overview

## Components

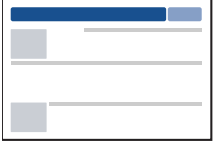
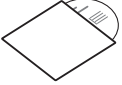
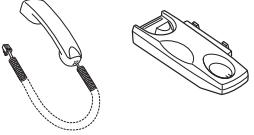
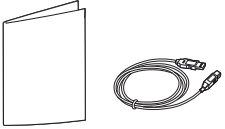
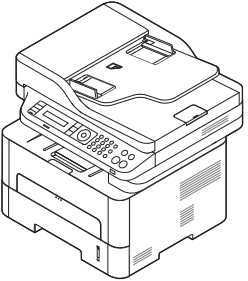
	
Power cord	Quick installation guide
	
Software CD <sup>a</sup>	Handset <sup>b</sup>
	
Misc. accessories <sup>c</sup>	Machine

a. The software CD contains the print drivers and software applications.

b. Handset model only (see "Variety feature" on page 10)

c. Miscellaneous accessories included with your machine may vary by country of purchase and specific model.

# Machine overview

## Front view



- This illustration may differ from your machine depending on your model.
- Some features and optional goods may not be available depending on model or country (see "Features by model" on page 7).

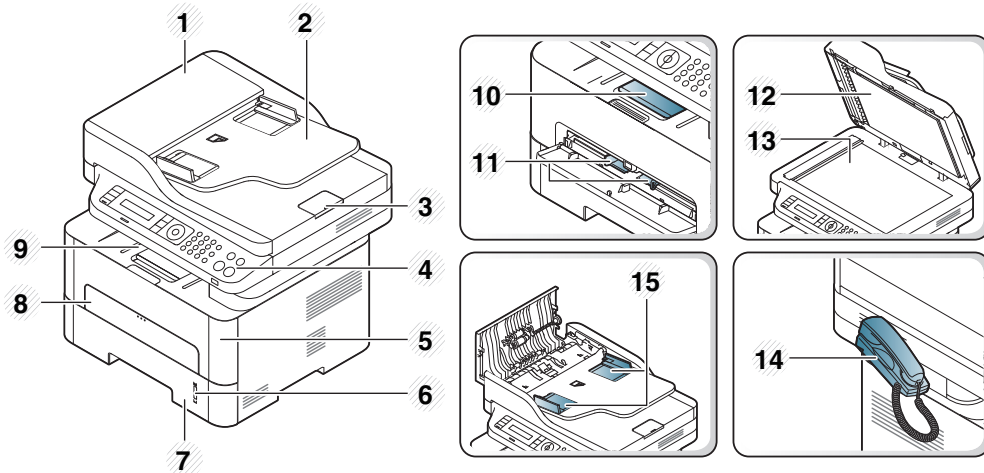

1	Document feeder cover	9	Output tray
2	Document feeder input tray	10	Output support
3	Document feeder output support	11	Paper width guide on a manual feeder
4	Control Panel	12	Scanner lid
5	Front cover	13	Scanner glass

6	Paper level indicator	14	Handset <sup>a</sup>
7	Tray	15	Paper width guide on a document feeder
8	Manual feeder tray	16	NFC tag <sup>b</sup> (Near Field Communication)

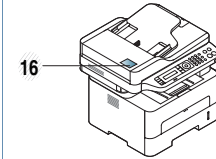

- a. Handset model only (see "Variety feature" on page 10).  
 b. M288x series only.

# Machine overview

## Rear view



- This illustration may differ from your machine depending on your model.
- Some features and optional goods may not be available depending on model or country (see "Features by model" on page 7).

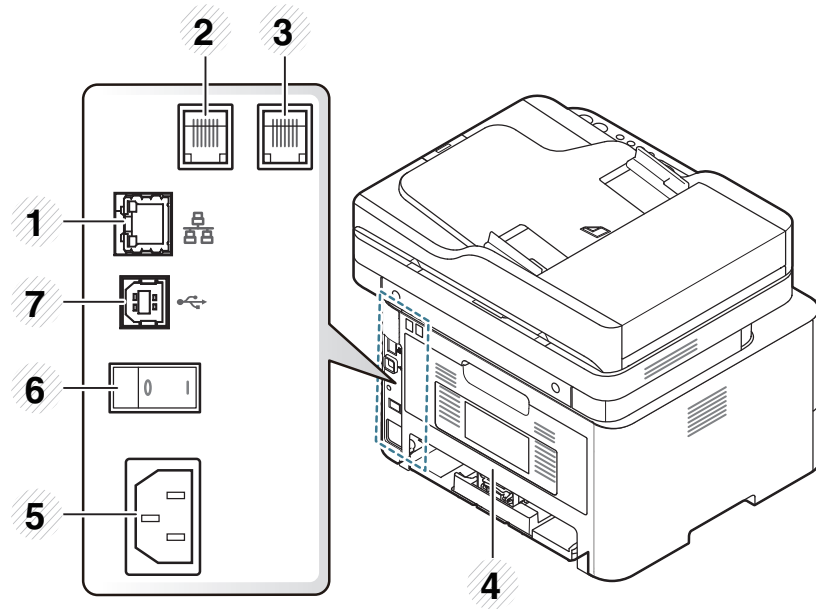

3	Extension telephone socket (EXT) <sup>c</sup>	7	USB port
4	Rear cover		

- a. M267xN/M267xFN/M267xHN/M267xHN/M287xND/M287xFD/M287xDW/M287xFW/M287xHN/M288xFW/M288xHW only.
- b. May not be available depending on models or your country.
- c. M267xF/M267xFN/M267xHN/M267xHN/M287xFD/M287xFW/M287xHN/M288xFW/M288xHW only.

1	Network port <sup>a</sup>	5	Power receptacle
2	Telephone line socket (Line) <sup>b</sup>	6	Power switch <sup>b</sup>

# Control panel overview







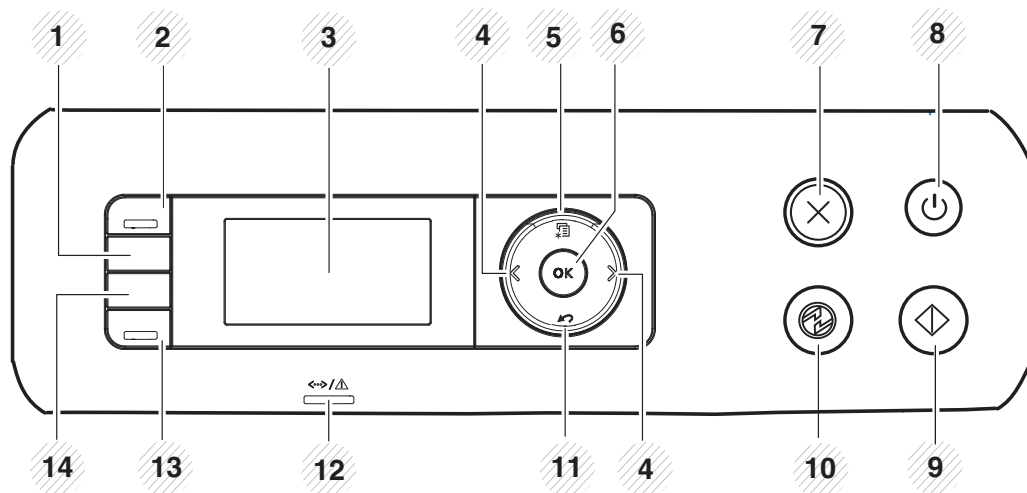

This control panel may differ from your machine depending on its model. There are various types of control panels.

## M267xN/M287xND/M287xDW



1	<b>ID Copy</b>	Allows you to copy both sides of an ID card like a driver's license on a single side of paper (see "ID card copying" on page 64).
2	<b>Scan to</b>	Switches between scan and copy mode. The <b>Scan to</b> LED turns on scan mode and turns off on copy mode.
3	<b>Display screen</b>	Shows the current status and displays prompts during an operation.

4	<b>Left/Right Arrows</b>	Scrolls through the options available in the selected menu and increases or decreases values.
5	<b>Menu</b>	 Opens Menu mode and scrolls through the available menus (see "Accessing the menu" on page 33).
6	<b>OK</b>	Confirms the selection on the screen.
7	<b>Stop/ Clear</b>	 Stops an operations at any time.
8	<b>Power/ Wake Up</b>	 Turns the power on or off, or wakes up the machine from the power save mode. If you need to turn the machine off, press this button for more than three seconds.
9	<b>Start</b>	 Starts a job.
10	<b>Power Saver</b>	 Goes into power save mode.
11	<b>Back</b>	 Sends you back to the upper menu level.
12	<b>Status LED</b>	Indicates the status of your machine (see "Understanding the status LED" on page 107).
13	<b>Eco</b>	Turn on Eco mode to reduce toner consumption and paper usage (see "Eco printing" on page 58).





# Control panel overview



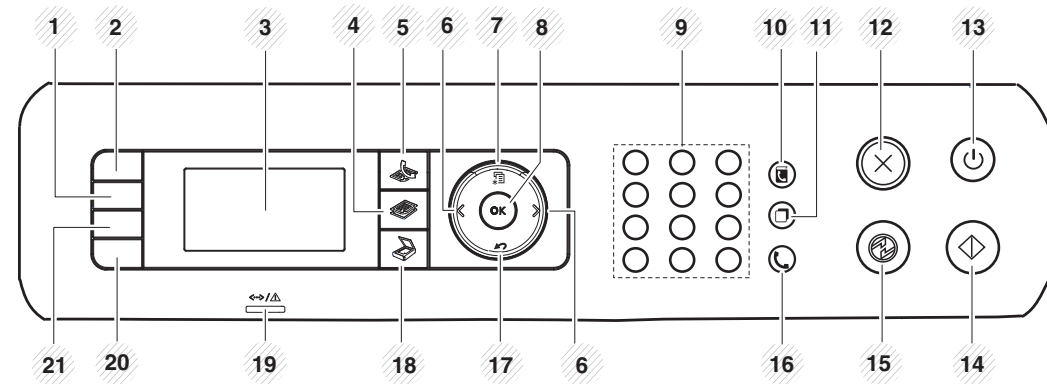





14	<b>Darkness</b>	Adjust the brightness level to make a copy for easier reading, when the original contains faint markings and dark images.
	<b>WPS</b>	Configures the wireless network connection easily without a computer (see "Wireless network setup" on page 165).



## M267xF/M267xFN/M287xFD/M267xFH/M287xFW/ M267xHN/M287xHN/M288xFW/M288xHW



1	<b>Darkness</b>		Adjust the brightness level to make a copy for easier reading, when the original contains faint markings and dark images.
2	<b>ID Copy</b>		Allows you to copy both sides of an ID card like a driver's license on a single side of paper (see "ID card copying" on page 64).
3	<b>Display screen</b>		Shows the current status and displays prompts during an operation.
4	<b>Copy</b>		Switches to Copy mode.
5	<b>Fax</b>		Switches to Fax mode.

# Control panel overview

6	<b>Left/Right Arrows</b>		Scrolls through the options available in the selected menu and increases or decreases values.
7	<b>Menu</b>		Opens Menu mode and scrolls through the available menus.
8	<b>OK</b>		Confirms the selection on the screen.
9	<b>Numeric keypad</b>		Dials a number or enters alphanumeric characters.
10	<b>Address Book</b>		Allows you to store frequently used fax numbers or search for stored fax numbers.
11	<b>Redial/ Pause(-)</b>		Redials the last number in ready mode, or inserts a pause(-) into a fax number in edit mode.
12	<b>Stop/ Clear</b>		Stops an operations at any time.
13	<b>Power/ Wake Up</b>		Turns the power on or off, or wakes up the machine from the power save mode. If you need to turn the machine off, press this button for more than three seconds.
14	<b>Start</b>		Starts a job.
15	<b>Power Saver</b>		Goes into power save mode.
16	<b>On Hook Dial</b>		When you press this button, you can hear a dial tone. Then enter a fax number. It is similar to making a call using speaker phone.

17	<b>Back</b>		Sends you back to the upper menu level.
18	<b>Scan</b>		Switches to Scan mode.
19	<b>Status LED</b>		Indicates the status of your machine (see "Understanding the status LED" on page 107).
20	<b>Eco</b>		Turn on Eco mode to reduce toner consumption and paper usage (see "Eco printing" on page 58).

# Control panel overview

21

## Print Screen

Press this button and the display will **Print Screen?** on the display screen. If you want to print only the active screen, select the **Active**. If you want to print the whole screen, select **Full**.



- **Print Screen** can only be used in the Windows and Mac operating systems.
- You can only use this function with USB-connected machine.
- When printing the active window/whole monitor screen using the print screen button, the machine may use more toner depending on what is being printed.
- You can only use this function if the machine's Samsung Easy Printer Manager program is installed. If you are a Mac OS user, you need to enable **Screen Print Settings** from the Samsung Easy Printer Manager to use the Print Screen feature.

## Reduce/Enlarge

You can reduce or enlarge the size of a copied image from 25% to 400% when you copy original documents from the scanner glass. (see "Reduced or enlarged copy" on page 63).

## WPS

Configures the wireless network connection easily without a computer (see "Wireless network setup" on page 165).

# Turning on the machine



Illustrations on this user's guide may differ from your machine depending on its options or models. Check your machine type (see "Machine overview" on page 21).

- 1 Connect the machine to the electricity supply first.  
Turn the switch on if the machine has a power switch.

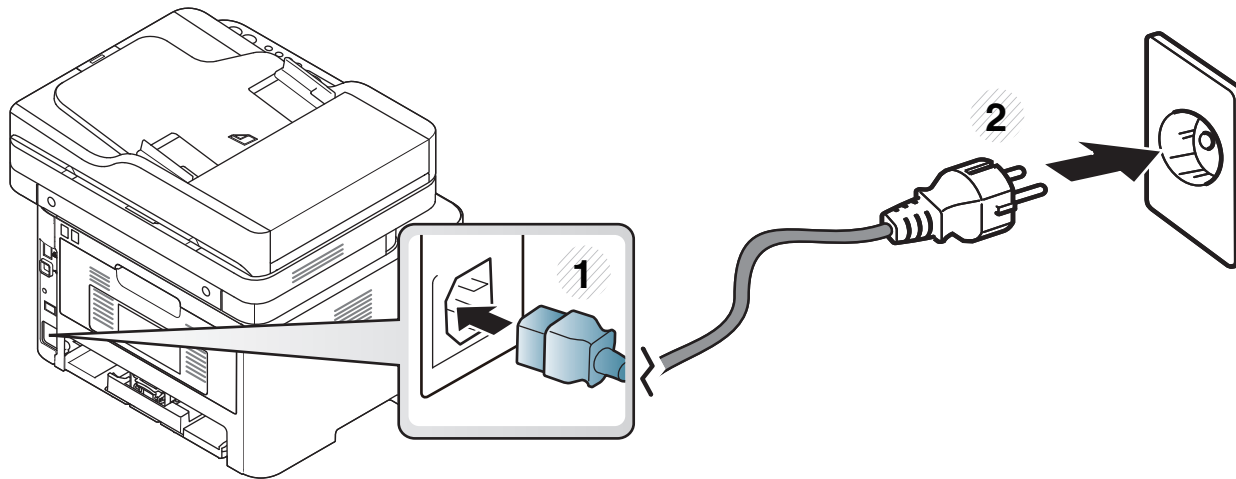

For M267xN and M287xND/M287xDW, also press the  (**Power/Wake Up**) button to turn the machine on.

# Installing the driver locally

A locally connected machine is a machine directly attached to your computer using the cable. If your machine is attached to a network, skip the following steps below and go on to installing a network connected machine's driver (see "Installing driver over the network" on page 153).



- If you are a Mac, Linux, or Unix OS user, refer to the "Software Installation" on page 143.
- The installation window in this User's Guide may differ depending on the machine and interface in use.
- Only use a USB cable no longer than 3 meters (118 inches).

## Windows

- 1 Make sure that the machine is connected to your computer and powered on.
- 2 Insert the supplied software CD into your CD-ROM drive.

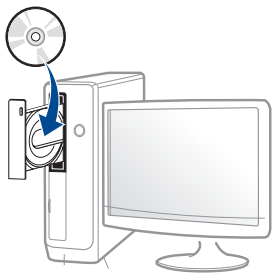

If the installation window does not appear, click **Start > All programs > Accessories > Run**.

X:\Setup.exe replacing "X" with the letter, which represents your CD-ROM drive and click **OK**.

- For Windows 8,

If the installation window does not appear, from **Charms**, select **Search > Apps** and search for **Run**. Type in X:\Setup.exe, replacing "X" with the letter that represents your CD-ROM drive and click **OK**.

If "Tap to choose what happens with this disc." pop-up window appears, click the window and select **Run Setup.exe**.

- 3 Review and accept the installation agreements in the installation window. Then, click **Next**.
- 4 Select **USB connection** on the **Printer Connection Type** screen. Then, click **Next**.
- 5 Follow the instructions in the installation window.



You can select the software applications in the **Select Software to Install** window.

# Installing the driver locally

## From the Windows 8 Start Screen

---



- The V4 driver is automatically downloaded from the Windows Update if your computer is connected to the Internet. If not, you can manually download the V4 driver from Samsung website, [www.samsung.com](http://www.samsung.com) > find your product > Support or downloads.
- You can download Samsung Printer Experience app from the **Windows Store**. You need have a Microsoft account to use the Windows **Store**.
  - 1 From **Charms**, select **Search**.
  - 2 Click **Store**.
  - 3 Search and click **Samsung Printer Experience**.
  - 4 Click **Install**.
- If you install the driver using the supplied software CD, V4 driver is not installed. If you want to use the V4 driver in the **Desktop** screen, you can download from the Samsung website, [www.samsung.com](http://www.samsung.com) > find your product > Support or downloads.
- If you want to install Samsung's printer management tools, you need to install them using the supplied software CD.

- 1 Make sure that your computer is connected to the Internet and powered on.
- 2 Make sure that the machine is powered on.
- 3 Connect the computer and the machine with a USB cable.  
The driver is automatically installed from the **Windows Update**.

# Reinstalling the driver

If the printer driver does not work properly, follow the steps below to reinstall the driver.

## Windows

- 1 Make sure that the machine is connected to your computer and powered on.
- 2 From the **Start** menu, select **Programs** or **All Programs** > **Samsung Printers** > **Uninstall Samsung Printer Software**.
  - For Windows 8,
    - 1 From Charms, select **Search** > **Apps**.
    - 2 Search and click **Control Panel**.
    - 3 Click **Programs and Features**.
    - 4 Right-click the driver you want to uninstall and select **Uninstall**.
- 3 Follow the instructions in the installation window.

- 4 Insert the software CD into your CD-ROM drive and install the driver again (see "Installing the driver locally" on page 29).

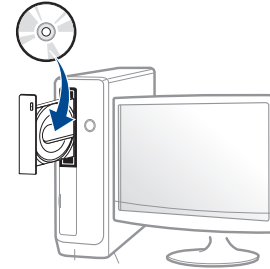

## From the Windows 8 Start Screen

- 1 Make sure that the machine is connected to your computer and powered on.
- 2 Click on the **Uninstall Samsung Printer Software** tile in the **Start** screen.
- 3 Follow the instructions in the window.



- If you cannot find a Samsung Printer Software tile, uninstll from the desktop screen mode.
- If you want to uninstall Samsung's printer management tools, from the **Start** screen, right-click the app > **Uninstall** > right-click the program you want to delete > **Uninstall** and follow the instruction in the window.



## 2. Menu Overview and Basic Setup

This chapter provides information about the overall menu structure and the basic setup options.

- **Menu overview** 33
- **Machine's basic settings** 37
- **Media and tray** 39
- **Basic printing** 55
- **Basic copying** 61
- **Basic scanning** 66
- **Basic faxing** 67

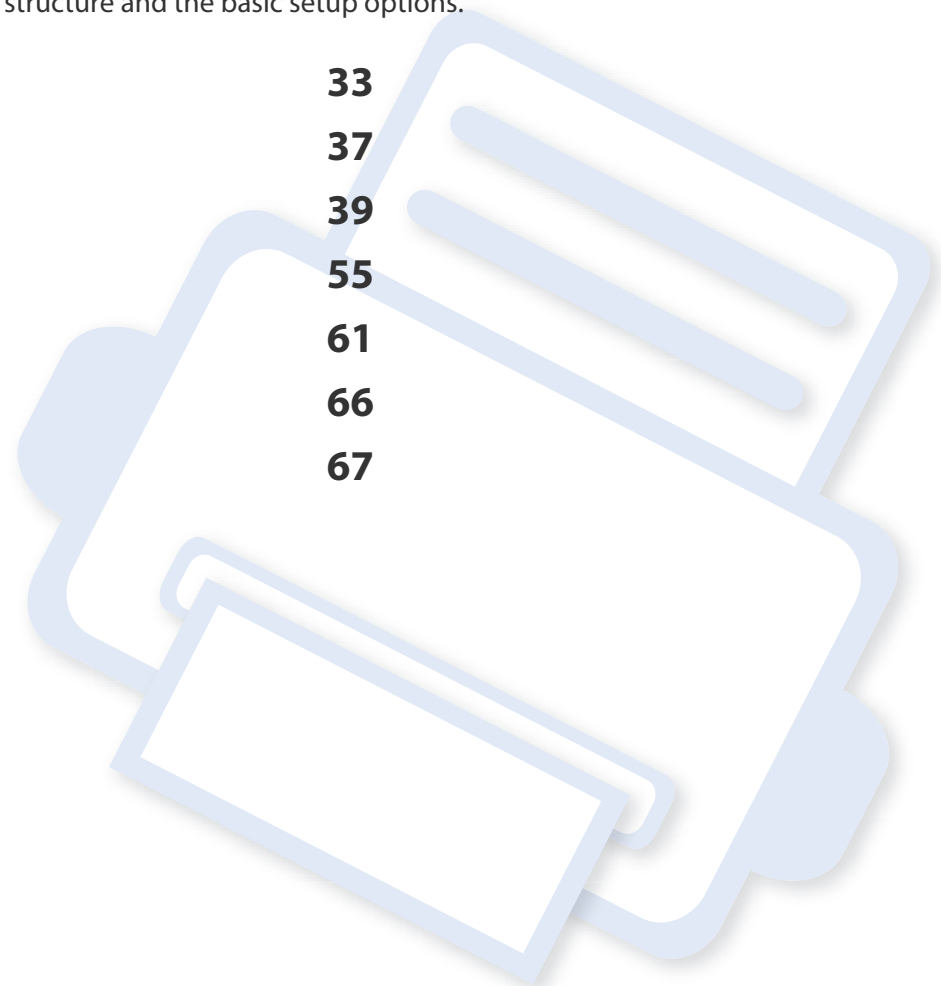



# Menu overview

The control panel provides access to various menus to set up the machine or use the machine's functions.



- An asterisk (\*) appears next to the currently selected menu.
- Some menus may not appear on the display depending on options or models. If so, it is not applicable to your machine.
- Some menu names may differ from your machine depending on its options or the models.
- The menus are described in the Advanced Guide (see "Useful Setting Menus" on page 208).

6 Press  (**Stop/Clear**) to return to the ready mode.

## Accessing the menu

- 1 Select the Fax, Copy, or Scan button on the control panel depending on the feature to be used.
- 2 Select  (**Menu**) until the menu you want appears on the bottom line of the display and press **OK**.
- 3 Press the left/right arrows until the needed menu item appears and press **OK**.
- 4 If the setting item has sub menus, repeat step 3.
- 5 Press **OK** to save the selection.

# Menu overview

Fax Feature <sup>a</sup> (see "Fax Feature" on page 214)		Fax Setup <sup>a</sup> (see "Sending setup" on page 215, "Receiving setup" on page 216)		Copy Feature (see "Copy feature" on page 211)	
<b>Darkness</b>	<b>Rcv. Forward</b>	<b>Sending</b>	<b>DRPD</b>	<b>Original Size</b>	<b>Photo</b>
Light+5- Light+1	Forward to Fax	Redial Times	Ring to Answer	Reduce/Enlarge	Collation
Normal	Forward to PC	Redial Term	Stamp Rcv Name	Duplex <sup>d</sup>	Layout
Dark+1- Dark+5	Forward & Print	Prefix Dial	Rcv Start Code	1 Sided	Normal
<b>Resolution</b>	<b>Secure Receive</b>	<b>ECM Mode</b>	<b>Auto Reduction</b>	1->2Sided	2-Up
Standard	Off	Modem Speed	Discard Size	1->2Sided Rot.	4-Up
Fine	On	Fax Confirm.	Junk Fax Setup	<b>Darkness</b>	ID Copy
Super Fine	Print	Image TCR	DRPD Mode	Light+5- Light+1	Adjust Bkgd.
Photo Fax	Add Page	Dial Mode <sup>b</sup>	Duplex Print <sup>c</sup>	Normal	Off
Color Fax	Cancel Job	<b>Receiving</b>	Change Default	Dark+1- Dark+5	Auto
<b>Original Size</b>		Receive Mode	Darkness	<b>Original Type</b>	Enhance Lev.1
<b>Multi Send</b>		Fax	Resolution	Text	Enhance Lev.2
<b>Delay Send</b>		Tel	Original Size	Text/Photo	Erase Lev.1- Erase Lev.4
<b>Priority Send</b>		Ans/Fax	Manual TX/RX		
<b>Send Forward</b>					

a. M267xF/ M267xFN/ M287xFD/ M287xFW/ M267xFH/ M267xHN/ M287xHN/M288xFW/M288xHW only.

b. This option may not be available depending on your country.

c. M287xFD/M287xFW/ M287xHN/M288xFW/M288xHW only.

d. M287xND/M287xFD/M287xDW/M287xFW/M287xHN/M288xFW/M288xHW only.

# Menu overview

Copy Setup (see "Copy Setup" on page 213)	System Setup (see "System setup" on page 217)			Print Setup <sup>e</sup> (see "Print menu" on page 210)
<b>Change Default</b> <b>Original Size</b> <b>Copies</b> <b>Reduce/Enlarge</b> <b>Duplex<sup>a</sup></b> <b>Darkness</b> <b>Original Type</b> <b>Collation</b>	<b>Machine Setup</b> <b>Machine ID<sup>b</sup></b> <b>Fax Number<sup>b</sup></b> <b>Date &amp; Time<sup>b</sup></b> <b>Clock Mode<sup>b</sup></b> <b>Language</b> <b>Default Mode<sup>b</sup></b> <b>Power Save</b> <b>Auto Power Off<sup>c</sup></b> <b>Wakeup Event</b> <b>System Timeout</b> <b>Job Timeout</b> <b>Altitude Adj.</b> <b>Auto Continue</b> <b>Paper Substit.</b>	<b>Toner Save</b> <b>Eco Settings</b> <b>Paper Setup</b> <b>Paper Size</b> <b>Paper Type</b> <b>Paper Source</b> <b>Margin</b> <b>Sound/Volume<sup>b</sup></b> <b>Key Sound</b> <b>Alarm Sound</b> <b>Speaker</b> <b>Ringer</b> <b>Report</b> <b>Configuration</b> <b>Demo Page</b> <b>Network Conf.<sup>d</sup></b> <b>Supplies Info.</b>	<b>Usage Counter</b> <b>Fax Received<sup>b</sup></b> <b>Fax Sent<sup>b</sup></b> <b>Scheduled Jobs<sup>b</sup></b> <b>Fax Confirm.<sup>b</sup></b> <b>Junk Fax<sup>b</sup></b> <b>PCL Font List<sup>e</sup></b> <b>Address Book<sup>b</sup></b> <b>Maintenance</b> <b>CLR Empty Msg<sup>f</sup></b> <b>Supplies Life</b> <b>Image Mgr.</b> <b>TonerLowAlert</b> <b>ImgU.Low Alert<sup>g</sup></b> <b>Serial Number</b>	<b>Orientation</b> <b>Portrait</b> <b>Landscape</b> <b>Duplex</b> <b>Off</b> <b>Long Edge</b> <b>Short Edge</b> <b>Copies</b> <b>Resolution</b> <b>Clear Text</b> <b>Auto CR</b> <b>SkipBlankPages</b> <b>Emulation</b>

a. M287xND/ M287xFD/M287xDW/M287xFW/M287xHN/M288xFW/M288xHW only.

b. M267xF/ M267xFN/ M287xFD/M287xFW/M267xFH/ M267xHN/M287xHN/M288xFW/M288xHW only.

c. M267xN/ M287xND only.

d. M267xN/M267xFN/M287xND/ M287xFD/M287xDW/M287xFW/M267xHN/M287xHN/M288xFW/M288xHW only.

e. M287xND/M287xFD/M287xDW/M287xFW/M287xHN/M288xFW/M288xHW only.

# Menu overview

f. This option only appears when small amount of toner is left in the cartridge.

g. M2675/M2676/M2875/M2876/M2885/M2886 series only.

Network	
<b>TCP/IP (IPv4)<sup>a</sup></b>	<b>Wireless<sup>b</sup></b>
<b>DHCP</b>	<b>Wi-Fi ON/OFF<sup>b</sup></b>
<b>BOOTP</b>	<b>Wi-Fi Direct<sup>b</sup></b>
<b>Static</b>	<b>WPS Setting<sup>b</sup></b>
<b>TCP/IP (IPv6)<sup>a</sup></b>	<b>WLAN Setting<sup>c</sup></b>
<b>IPv6 Activate</b>	<b>WLAN Default<sup>b</sup></b>
<b>DHCPv6 Config</b>	<b>WLAN Signal<sup>b</sup></b>
<b>Ethernet Speed<sup>a</sup></b>	<b>Protocol Mgr.<sup>a</sup></b>
<b>Automatic</b>	<b>Net. Activate</b>
<b>10Mbps Half</b>	<b>Http Activate</b>
<b>10Mbps Full</b>	<b>WINS</b>
<b>100Mbps Half</b>	<b>SNMP V1/V2</b>
<b>100Mbps Full</b>	<b>UPnP(SSDP)</b>
	<b>MDNS</b>
	<b>SetIP</b>
	<b>SLP</b>
	<b>Network Conf.<sup>a</sup></b>
	<b>Clear Setting<sup>a</sup></b>

a. M267xN/M267xFN/M287xND/M287xFD/M287xDW/M287xFW/M267xHN/M288xFW/M288xHW only.

b. M287xDW/M287xFW/M288xFW/M288xHW only.

c. M287xFW/M288xFW only.

# Machine's basic settings



You can set the machine's settings by using the **Device Settings** in Samsung Easy Printer Manager program.

- For Windows and Mac users, you set from **Samsung Easy Printer**

**Manager** >  **(Switch to advanced mode)** > **Device Settings**, see "Device Settings" on page 272.

After installation is complete, you may want to set the machine's default settings.

To change the machine's default settings, follow these steps:



It may be necessary to press **OK** to navigate to lower-level menus for some models.

- 1 Select  **(Menu)** > **System Setup** > **Machine Setup** on the control panel.
- 2 Select the option you want, then press **OK**.
  - **Language:** change the language that is displayed on the control panel.
  - **Date & Time:** When you set the time and date, they are used in delay fax. They are printed on reports. If, however, they are not correct, you need to change it for the correct time being.



Enter the correct time and date using arrows or numeric keypad (see "Keypad letters and numbers" on page 226).

- Month = 01 to 12
- Day = 01 to 31
- Year = requires four digits
- Hour = 01 to 12
- Minute = 00 to 59

- **Clock Mode:** You can set your machine to display the current time using either a 12-hour or 24-hour format.
- **Power Save:** When you are not using the machine for a while, use this feature to save power.



When you press the  **(Power/Wake Up)** button, start printing, or a fax is received, the product will wake up from the power saving mode.

- **Altitude Adj.:** Print quality is affected by atmospheric pressure, which atmospheric pressure is determined by the height of the machine above sea level. Before you set the altitude value, determine the altitude where you are (see "Altitude adjustment" on page 225).
- 3 Select the option you want, then press **OK**.
  - 4 Press **OK** to save the selection.

# Machine's basic settings

5 Press  (**Stop/Clear**) button to return to ready mode.



Refer to below links to set other settings useful for using the machine.

- See "Entering various characters" on page 226.
- See "Keypad letters and numbers" on page 226.
- See "Setting the paper size and type" on page 50.
- See "Setting up the fax address book" on page 228.

# Media and tray

This chapter provides information on how to load print media into your machine.

## Selecting print media

You can print on a variety of print media, such as plain paper, envelopes, labels, and transparencies. Always use print media that meet the guidelines for use with your machine.

## Guidelines for select the print media

Print media that does not meet the guidelines outlined in this user's guide may cause the following problems:

- Poor print quality
- Increased paper jams
- Premature wear on the machine.

Properties, such as weight, composition, grain, and moisture content, are important factors that affect the machine's performance and the output quality.

When you choose print materials, consider the following:

- The type, size, and weight of the print media for your machine are described in print media specifications (see "Print media specifications" on page 118).
- Desired outcome: The print media you choose should be appropriate for your project.

- **Brightness:** Some print media are whiter than others and produce sharper, more vibrant images.
- **Surface smoothness:** The smoothness of the print media affects how crisp the printing looks on the paper.



- Some print media may meet all of the guidelines in this user's guide and still not produce satisfactory results. This may be the result of the sheets characteristics, improper handling, unacceptable temperature and humidity levels, or other variables over which cannot be controlled.
- Before purchasing large quantities of print media, ensure that it meets the requirements specified in this user's guide.



- Using print media that does not meet these specifications may cause problems or require repairs. Such repairs are not covered by Samsung's warranty or service agreements.
- The amount of paper put into the tray may differ according to media type used (see "Print media specifications" on page 118).
- Make sure not to use the inkjet photo paper with this machine. It could cause damage to the machine.
- Using flammable print media can cause a fire.
- Use designated print media (see "Print media specifications" on page 118).

# Media and tray



The use of flammable media or foreign materials left in the printer may lead to overheating of the unit and, in rare cases may cause a fire.

The amount of paper put into the tray may differ according to media type used (see "Print media specifications" on page 118).

## Tray overview

To change the size, you need to adjust the paper guides.

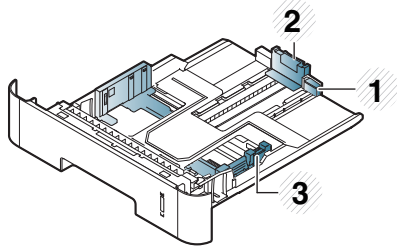

- 1 Tray extension guide
- 2 Paper length guide
- 3 Paper width guide



If you do not adjust the guide, it may cause paper registration, image skew, or jamming of the paper.



The paper quantity indicator shows the amount of paper in the tray.

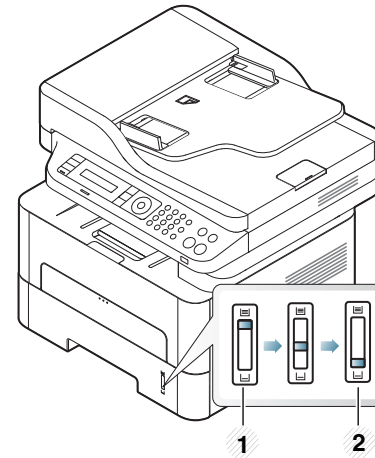

- 1 Full
- 2 Empty

## Paper type available for duplex printing



Duplex printing might not be available for some models (see "Features by model" on page 7).

Depending on the power voltage your machine uses, available paper types for duplex printing differs. Refer to the below table.



# Media and tray

Power voltage	Available paper
110V	Letter, Legal, US Folio, Oficio
220V	A4

# Media and tray

## Loading paper in the tray



When printing using the tray, do not load paper on the manual feeder, it may cause a paper jam.

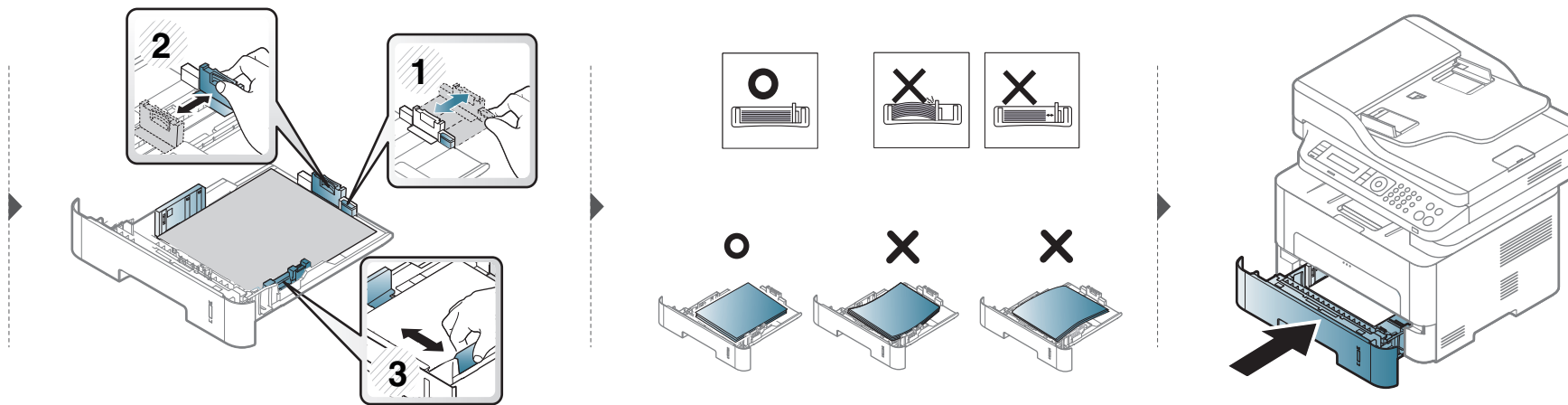
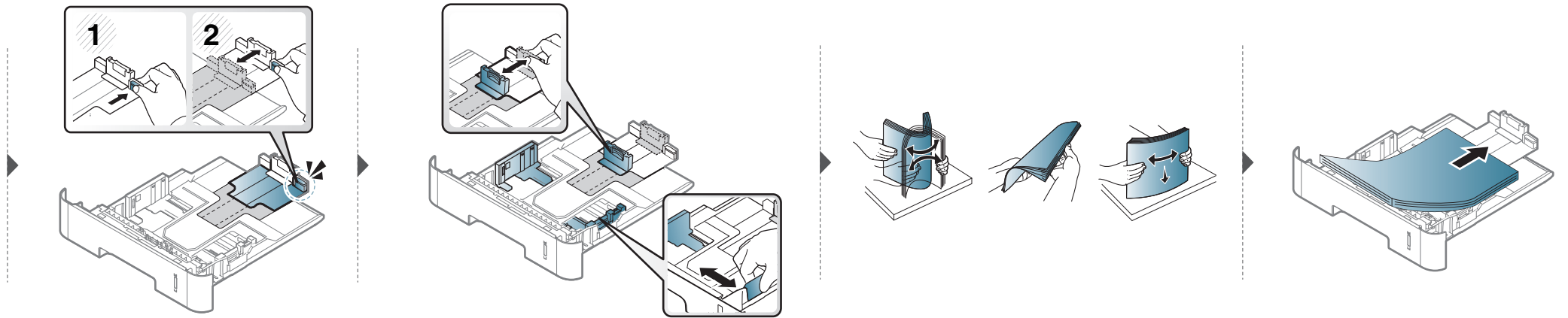

# Media and tray

## Loading in manual feeder

The manual feeder can hold special sizes and types of print material, such as postcards, note cards, and envelopes (see "Print media specifications" on page 118).



### Tips on using the manual feeder

- Load only one type, size and weight of print media at time in the manual feeder.
- To prevent paper jams, do not add paper while printing when there is still paper in the manual feeder.
- Print media should be loaded face up with the top edge going into the manual feeder first and be placed in the center of the tray.
- To ensure printing quality and to prevent paper jams, only load the available paper (see "Print media specifications" on page 118).
- Flatten any curl on postcards, envelopes, and labels before loading them into the manual feeder.
- When printing on special media, you must follow the loading guidelines (see "Printing on special media" on page 45).
- When papers overlap when printing using the manual feeder, open tray and remove the papers then try printing again.
- When paper does not feed well while printing, push the paper in manually until it starts feeding automatically.
- When the machine is in a power save mode, the machine does not feed paper from the manual feeder. Wake up the machine by pressing the power button before using the manual feeder.

# Media and tray

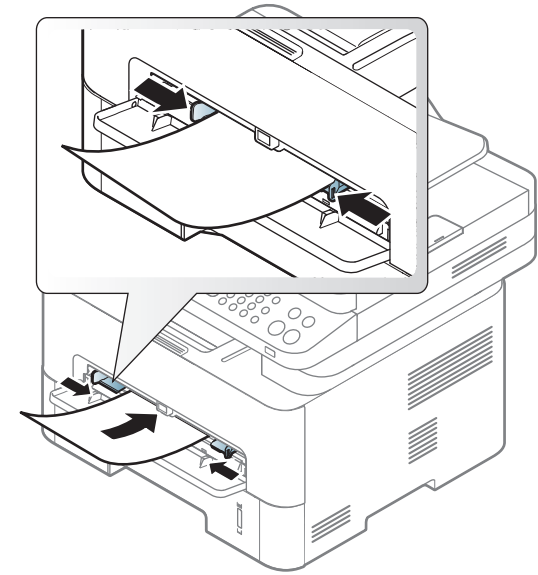
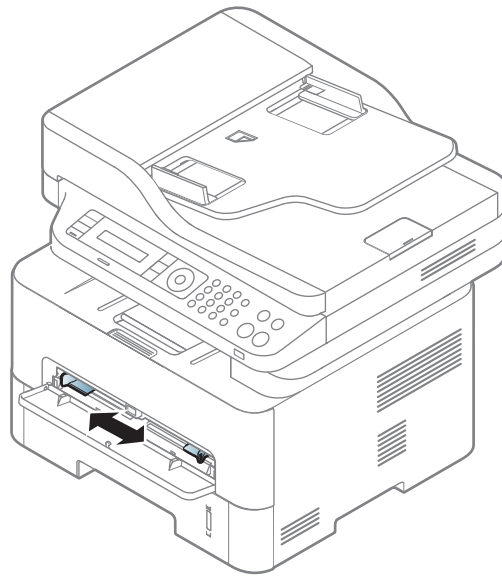
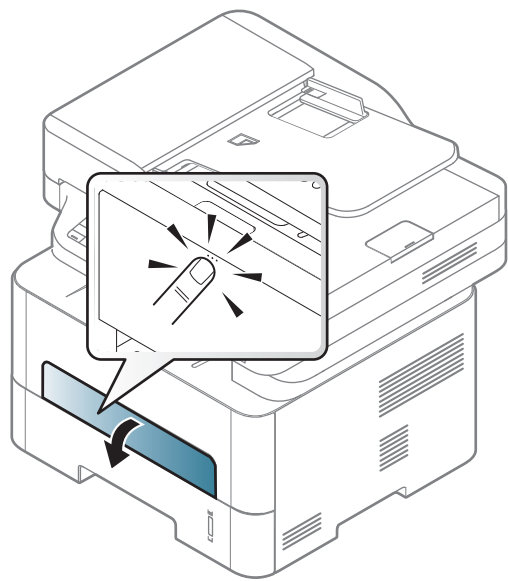

# Media and tray

## Printing on special media

The table below shows the special media usable in each tray.

The paper setting in the machine and driver should match to print without a paper mismatch error.

To change the paper setting set in the machine, from the **Samsung Easy Printer**

**Manager** select  **(Switch to advanced mode)** > **Device Settings**.

Or if your machine supports a display screen, you can set it using the  **(Menu)** button on the control panel.

Then, set the paper type from the **Printing preferences** window > **Paper** tab > **Paper Type** (see "Opening printing preferences" on page 57).



- When using special media, we recommend you feed one sheet at a time (see "Print media specifications" on page 118).
- **Printing the special media (Face up)**  
If special media are printed out with curl, wrinkles, crease, or black bold lines, open the rear cover and try printing again. Keep the rear cover opened during printing.

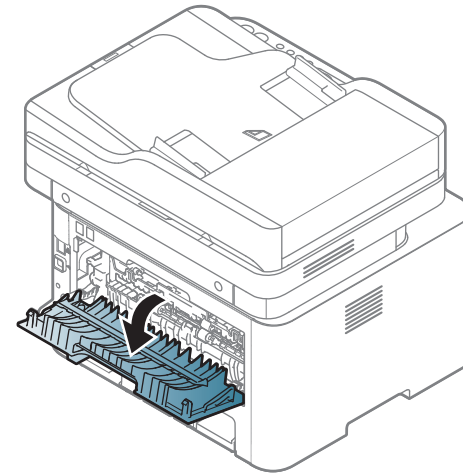

# Media and tray

To see paper weights for each sheet, refer to "Print media specifications" on page 118.

Types	Tray	Manual feeder
Plain	●	●
Thick	●	●
Thicker		●
Thin	●	●
Bond	●	●
Color		●
CardStock	●	●
Labels		●
Transparency		●
Envelope		●
Thick Envelope		●
Preprinted		●
Cotton		●
Recycled	●	●
Archive	●	●

(●: Included, Blank: Not available)

## Envelope

Printing successfully on envelopes depends upon the quality of the envelopes.

To print an envelope, place it as shown in the following figure.

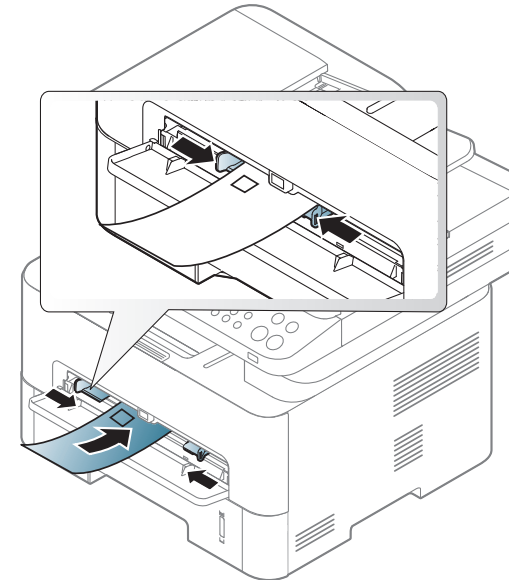

If envelopes are printed out with wrinkles, creases, or black bold lines, open the rear cover and try printing again. Keep the rear cover opened during printing.

- When selecting envelopes, consider the following factors:
  - **Weight:** should not exceed 90 g/m<sup>2</sup> otherwise; jams may occur.
  - **Construction:** should lie flat with less than 6 mm curl and should not contain air.
  - **Condition:** should not be wrinkled, nicked, nor damaged.

# Media and tray

- **Temperature:** should resist the heat and pressure of the machine during operation.
- Use only well-constructed envelopes with sharp and well-creased folds.
- Do not use stamped envelopes.
- Do not use envelopes with clasps, snaps, windows, coated lining, self-adhesive seals, or other synthetic materials.
- Do not use damaged or poorly made envelopes.
- Be sure the seam at both ends of the envelope extends all the way to the corner of the envelope.

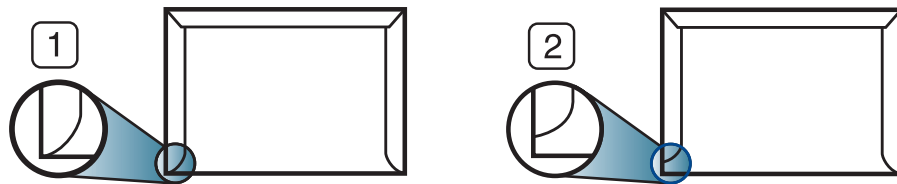

- 1 Acceptable
- 2 Unacceptable

- Envelopes with a peel-off adhesive strip or with more than one flap that folds over to seal must use adhesives compatible with the machine's fusing temperature for 0.1 second about 170°C (338 °F). The extra flaps and strips might cause wrinkling, creasing, or jams, and may even damage the fuser unit.
- For the best print quality, position margins no closer than 15 mm from the edges of the envelope.
- Avoid printing over the area where the envelope's seams meet.

## Transparency

To avoid damaging the machine, use only transparencies designed for use in laser printers.

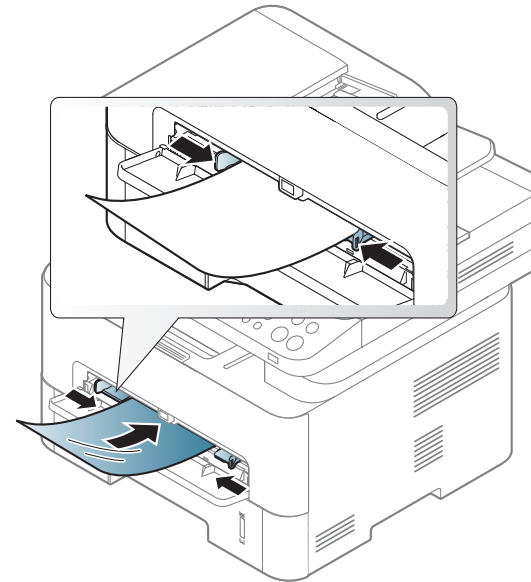

- Must withstand the machine's fusing temperature.
- Place them on a flat surface after removing them from the machine.
- Do not leave unused transparencies in the paper tray for long. Dust and dirt may accumulate on them, resulting in spotty printing.
- To avoid smudging caused by fingerprints, handle them carefully.
- To avoid fading, do not expose printed transparencies to prolonged sunlight.
- Ensure that transparencies are not wrinkled, curled, or have any torn edges.

# Media and tray

- Do not use transparencies that separate from the backing sheet.
- To prevent transparencies from sticking to each other, do not let the printed sheets stack up as they are being printed out.
- Recommended media: Transparency for a color laser printer by Xerox, such as 3R 91331(A4), 3R 2780 (Letter).

## Labels

To avoid damaging the machine, use only labels designed for use in laser printers.

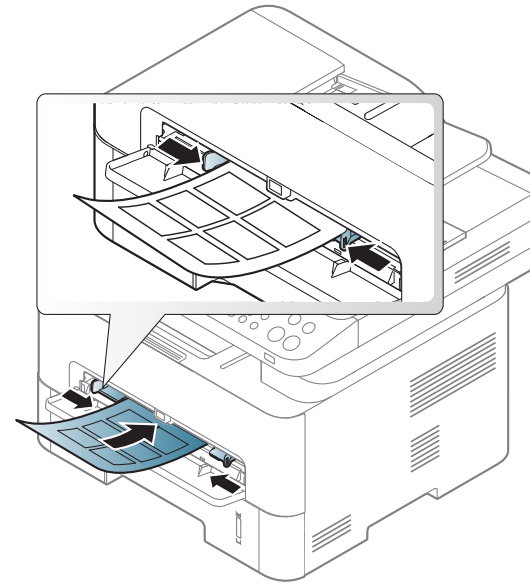

- When selecting labels, consider the following factors:
  - **Adhesives:** Should be stable at your machine's fusing temperature. Check your machine's specifications to view the fusing temperature (about 170°C (338°F)).
  - **Arrangement:** Only use labels with no exposed backing between them. Labels can peel off sheets that have spaces between the labels, causing serious jams.
  - **Curl:** Must lie flat with no more than 13 mm of curl in any direction.



# Media and tray

- **Condition:** Do not use labels with wrinkles, bubbles, or other indications of separation.
- Make sure that there is no exposed adhesive material between labels. Exposed areas can cause labels to peel off during printing, which can cause paper jams. Exposed adhesive can also cause damage to machine components.
- Do not run a sheet of labels through the machine more than once. The adhesive backing is designed for only a single pass through the machine.
- Do not use labels that are separating from the backing sheet or are wrinkled, bubbled, or otherwise damaged.

## Card stock/ Custom-sized paper

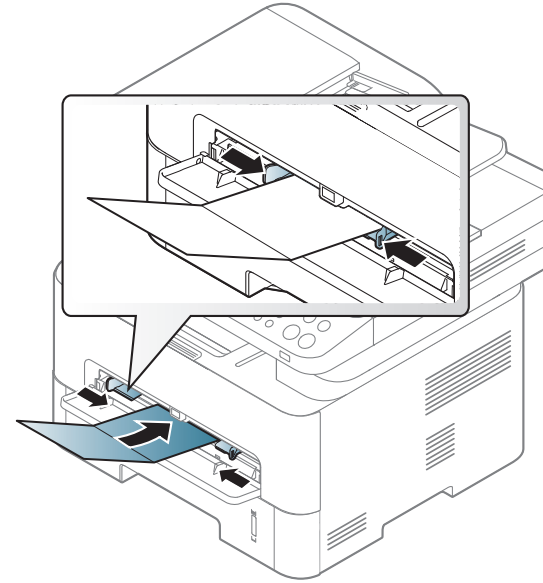

- In the software application, set the margins to at least 6.4 mm (0.25 inches) away from the edges of the material.

# Media and tray

## Preprinted paper

When loading preprinted paper, the printed side should be facing up with an uncurled edge at the front. If you experience problems with paper feeding, turn the paper around. Note that print quality is not guaranteed.

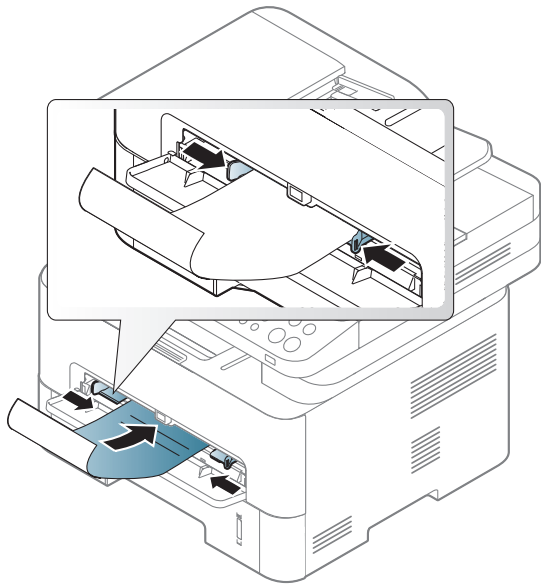

- Must be printed with heat-resistant ink that will not melt, vaporize, or release hazardous emissions when subjected to the machine's fusing temperature for 0.1 second (about 170°C (338°F)).
- Preprinted paper ink must be non-flammable and should not adversely affect machine rollers.
- Before you load preprinted paper, verify that the ink on the paper is dry. During the fusing process, wet ink can come off preprinted paper, reducing print quality.

## Setting the paper size and type

After loading paper in the paper tray, set the paper size and type using the control panel buttons.

The paper setting in the machine and driver should match to print without a paper mismatch error.

To change the paper setting set in the machine, from the **Samsung Easy Printer**

**Manager** select  **(Switch to advanced mode)** > **Device Settings**.

Or if your machine supports a display screen, you can set it using the  **(Menu)** button on the control panel.

Then, set the paper type from the **Printing preferences** window > **Paper** tab > **Paper Type** (see "Opening printing preferences" on page 57).



It may be necessary to press **OK** to navigate to lower-level menus for some models.

- 1 Select  **(Menu)** > **System Setup** > **Paper Setup** > **Paper Size** or **Paper Type** on the control panel.
- 2 Select the tray and the option you want.
- 3 Press **OK** to save the selection.

# Media and tray



- If you want to use special-sized paper such as billing paper, select the **Paper** tab > **Size** > **Edit...** and set **Custom Paper Size Settings** in the **Printing Preferences** (see "Opening printing preferences" on page 57).

## Using the output support



- The surface of the output tray may become hot if you print a large number of pages at one. Make sure that you do not touch the surface, and do not allow children near it.

The printed pages stack on the output support, and the output support will help the printed pages to align. Unfold the output support.

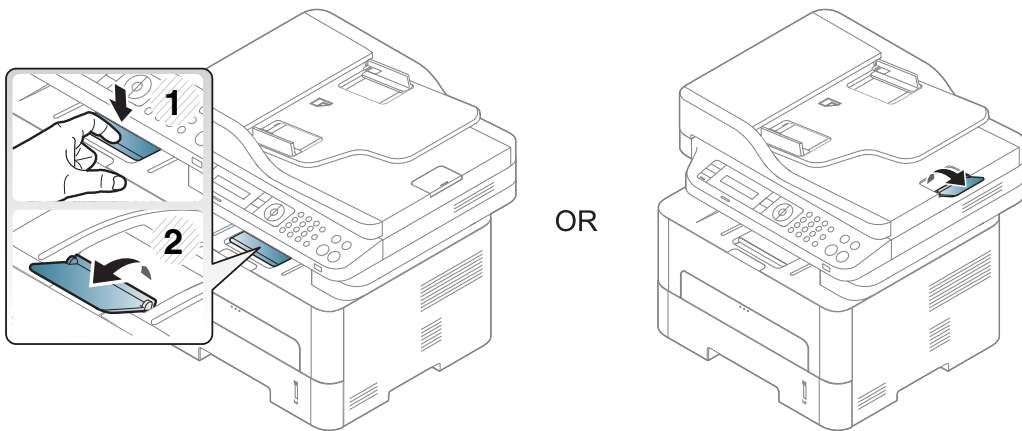

## Preparing originals

- Do not load paper smaller than 142 x 148 mm (5.6 x 5.8 inches) or larger than 216 x 356 mm (8.5 x 14 inches).
- Do not attempt to load the following s of paper, in order to prevent paper jam, low print quality and machine damage.
  - Carbon-paper or carbon-backed paper
  - Coated paper
  - Onion skin or thin paper
  - Wrinkled or creased paper
  - Curled or rolled paper
  - Torn paper
- Remove all staples and paper clips before loading.
- Make sure any glue, ink, or correction fluid on the paper is completely dry before loading.
- Do not load originals that include different sizes or weights of paper.
- Do not load booklets, pamphlets, transparencies, or documents with other unusual characteristics.

# Media and tray

## Loading originals

You can use the scanner glass or the document feeder to load an original for copying, scanning, and sending a fax.

### On the scanner glass

Using the scanner glass, you can copy or scan originals. You can get the best scan quality, especially for colored or gray-scaled images. Make sure that no originals are in the document feeder. If an original is detected in the document feeder, the machine gives it priority over the original on the scanner glass.

- 1 Lift and open the scanner lid.

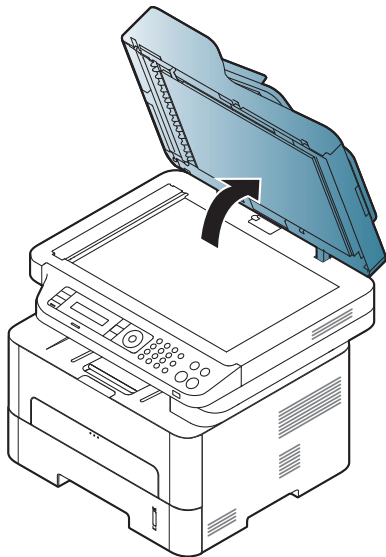

- 2 Place the original face down on the scanner glass. Align it with the registration guide at the top left corner of the glass.

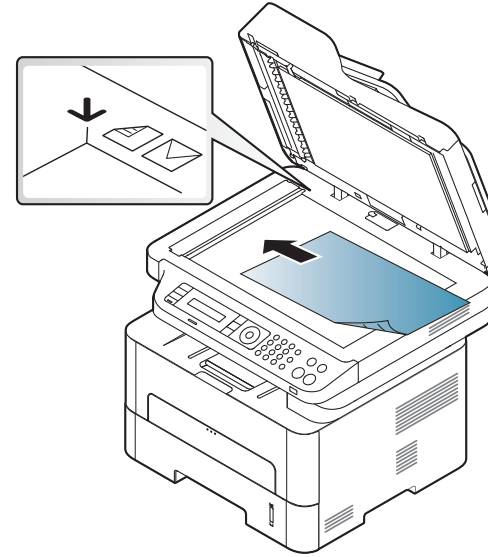

- 3 Close the scanner lid.



- Leaving the scanner lid open while copying may affect copy quality and toner consumption.
- Dust on the scanner glass may cause black spots on the printout. Always keep it clean (see "Cleaning the machine" on page 86).
- If you are copying a page from a book or magazine, lift the scanner lid until its hinges are caught by the stopper and then close the lid. If the book or magazine is thicker than 30 mm, start copying with the scanner lid open.

# Media and tray



- Be careful not to break the scanner glass. You may get hurt.
- Do not put hands while closing the scanner lid. The scanner lid may fall on your hands and get hurt.
- Do not look into the light from inside of the scanner while copying or scanning. It is harmful to eyes.

## In the document feeder

Using the document feeder, you can load up to 40 sheets of paper (80 g/m<sup>2</sup>, 21 lbs bond) for one job.

- 1 Flex or fan the edge of the paper stack to separate the pages before loading originals.

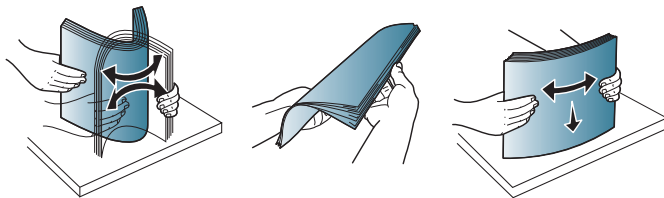

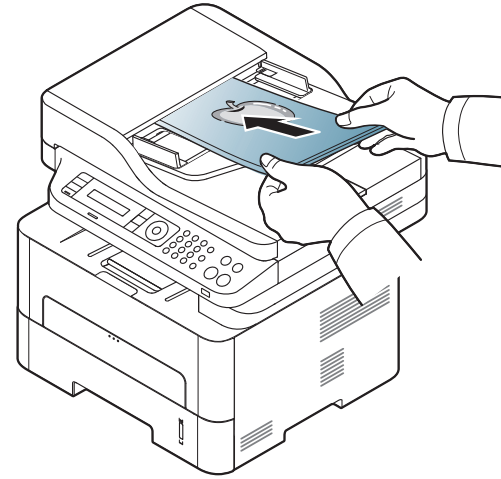

- 2 Load the original face up into the document feeder input tray. Make sure that the bottom of the original stack matches the paper size marked on the document input tray.

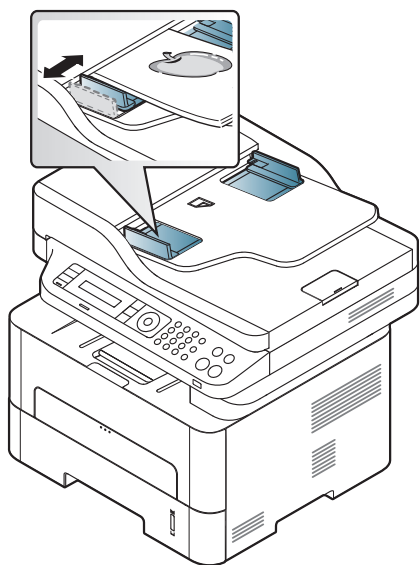

### 3 Adjust the document feeder width guides to the paper size.



- Dust on the document feeder glass may cause black lines on the printout. Always keep the glass clean (see "Cleaning the machine" on page 86).
- To print on both sides of the paper using the ADF, from the control panel press  (Copy) >  (Menu) > **Copy Feature** > **Duplex** > **1 -> 2 Sided** or **1 -> 2 Sided Rot.** and print on one side of the paper, then reload the sheet to print on the other side.  
Duplex printing might not be available for some models (see "Features by model" on page 7).

# Basic printing

## Basic printing



- For special printing features, refer to the Advanced Guide (see "Using advanced print features" on page 232).
- Depending on models or options, some menus may not be supported (see "Features by model" on page 7).

### Printing



- If you are a Mac, Linux, or UNIX operating systems user, refer to the "Mac printing" on page 239 or "Linux printing" on page 241 UNIX.
- For Windows 8 user, see "Basic printing" on page 277.

The following **Printing Preferences** window is for Notepad in Windows 7.

- 1 Open the document you want to print.
- 2 Select **Print** from the **File** menu.

- 3 Select your machine from the **Select Printer** list.

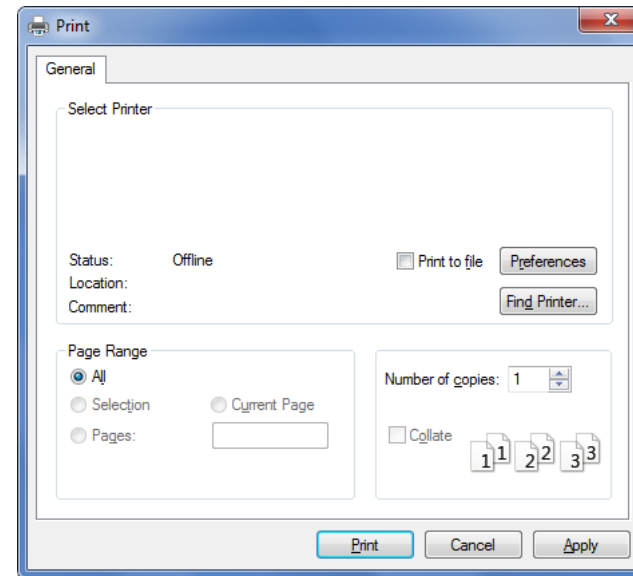

- 4 The basic print settings including the number of copies and print range are selected within the **Print** window.





To take advantage of the advanced printing features, click **Properties** or **Preferences** from the Print window (see "Opening printing preferences" on page 57).

- 5 To start the print job, click **OK** or **Print** in the **Print** window.

# Basic printing

## Canceling a print job

If the print job is waiting in the print queue or print spooler, cancel the job as follows:





- You can access this window by simply double-clicking the machine icon (  ) in the Windows task bar.
- You can also cancel the current job by pressing  (**Stop/Clear**) button on the control panel.



# Basic printing

## Opening printing preferences



- The **Printing Preferences** window that appears in this user's guide may differ depending on the machine in use.
- When you select an option in **Printing Preferences**, you may see a warning mark  or . An  mark means you can select that certain option but it is not recommended, and an  mark means you cannot select that option due to the machine's setting or environment.
- For Windows 8 user, see "Opening more settings" on page 278.

- 1 Open the document you want to print.
- 2 Select **Print** from the file menu. The **Print** window appears.
- 3 Select your machine from the **Select Printer**.
- 4 Click **Properties** or **Preferences**.



The screenshot may differ depending on model.

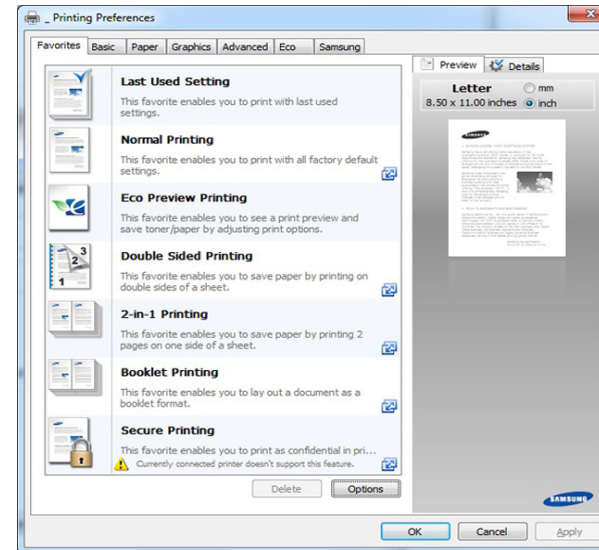

- You can apply **Eco** features to save paper and toner before printing (see "Easy Eco Driver" on page 265).
- You can check the machine's current status pressing the **Printer Status** button (see "Using Samsung Printer Status" on page 273).

## Using a favorite setting

The **Favorites** option, which is visible on each preferences tab except for **Favorites** tab and **Samsung** tab, allows you to save the current preferences for future use.

# Basic printing

To save a **Favorites** item, follow these steps:

- 1 Change the settings as needed on each tab.
- 2 Enter a name for the item in the **Favorites** input box.

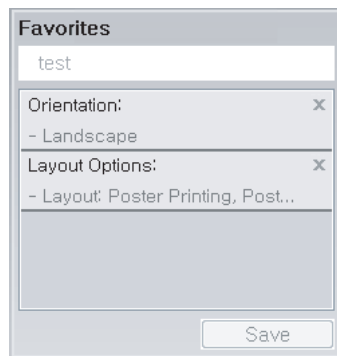

- 3 Click Save.
- 4 Enter name and description, and then select the desired icon.
- 5 Click **OK**. When you save **Favorites**, all current driver settings are saved.



To use a saved setting, select it in the **Favorites** tab. The machine is now set to print according to the settings you have selected. To delete saved settings, select it in the **Favorites** tab and click **Delete**.

## Using help

Click the option you want to know on the **Printing Preferences** window and press **F1** on your keyboard.

## Eco printing

The **Eco** function reduces toner consumption and paper usage. The **Eco** function allows you to save print resources and lead you to eco-friendly printing.

If you press the **Eco** button from the control panel, Eco mode is enabled. The default setting of Eco mode is double-sided printing (long edge), multiple pages per side (2-up), skip blank pages, and toner save. Some features may not be available depending on the model.



- Double-sided printing (Long Edge) feature is only available for duplex models (see "Variety feature" on page 10).
- Depending on the printer driver you use, skip blank pages may not work properly. If skip blank pages feature does not work properly, set the feature from the Easy Eco Driver (see "Easy Eco Driver" on page 265).

# Basic printing

## Setting Eco mode on the control panel



- Accessing menus may differ from model to model (see "Accessing the menu" on page 33).
- It may be necessary to press **OK** to navigate to lower-level menus for some models.

- 1 Select  (Menu) > **System Setup** > **Machine Setup** > **Eco Settings** on the control panel.
- 2 Select the option you want and press **OK**.
  - **Default Mode:** Select this to turn on or off the Eco mode (Duplex (long edge), Toner save, 2-up, and Skip blank pages).

Duplex printing and Skip blank pages might not be available for some models you use (see "Features by model" on page 7).

    - **Off:** Set the Eco mode off.
    - **On:** Set the Eco mode on.



If you set the Eco mode on with a password from the SyncThru™ Web Service (**Settings** tab > **Machine Settings** > **System** > **Eco Settings**), the **On force** message appears. You have to enter the password to change the Eco mode status.

- **Change Template:** Follow the settings from SyncThru™ Web Service or Samsung Easy Printer Manager. Before you select this item, you must set the Eco function in SyncThru™ Web Service (**Settings** tab > **Machine Settings** > **System** > **Eco Settings**) or Samsung Easy Printer Manager (**Device Settings** > **Eco**).

- 3 Press **OK** to save the selection.

## Setting Eco mode on the driver

Open the Eco tab to set Eco mode. When you see the eco image (  ), that means the Eco mode is currently enabled.

### Eco options

- **Printer Default:** Follows the settings from the machine's control panel.
- **None:** Disables Eco mode.
- **Eco Printing:** Enables Eco mode. Activate the various eco items you want to use.
- **Password:** If the administrator has enabled Eco mode, you have to enter the password to change the status.

**Result Simulator** shows the results of reduced emission of carbon dioxide, used electricity, and the amount of saved paper in accordance with the settings you selected.

- The results are calculated on the basis that the total number of printed paper is one hundred without a blank page when the Eco mode is disabled.
- Refers to the calculation coefficient about CO<sub>2</sub>, energy, and paper from **IEA**, the index of Ministry of Internal Affairs and Communication of Japan and [www.remanufacturing.org.uk](http://www.remanufacturing.org.uk). Each model has a different index.
- The power consumption in printing mode refers to the average printing power consumption of this machine.
- The actual saved or reduced amount may differ depending on the operating system used, computing performance, application software, connection method, media, media size, job complexity, etc.



# Basic copying

## Basic copying



- For special printing features, refer to the Advanced Guide (see "Copy menu" on page 211).
- Accessing menus may differ from model to model (see "Accessing the menu" on page 33 or "Control panel overview" on page 24).
- Depending on models or options, some menus may not be supported (see "Features by model" on page 7).

### Basic copy

1 Select  (copy) >  (Menu) > **Copy Feature** on the control panel.

Or select  (Menu) > **Copy Feature** on the control panel.

2 Place a single document (see "Loading originals" on page 52).

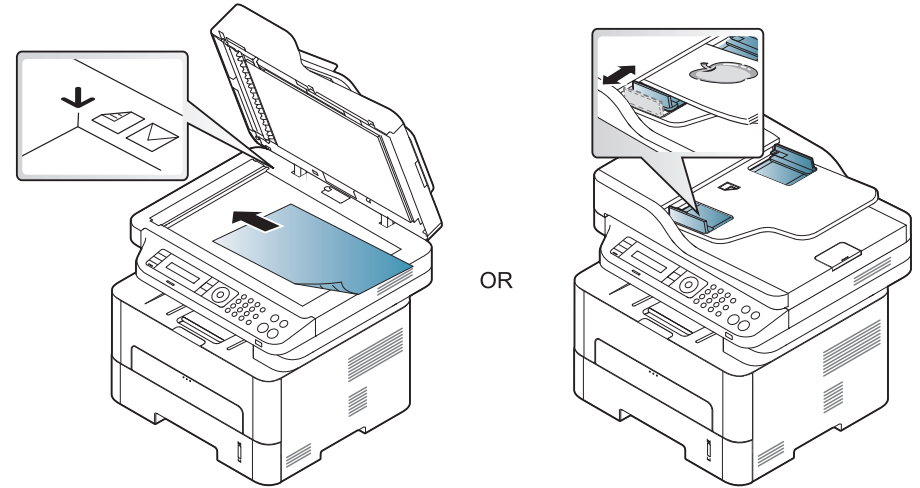

3 If you want to customize the copy settings including **Reduce/Enlarge**, **Darkness**, **Original**, and more by using the control panel buttons (see "Changing the settings for each copy" on page 62).

4 Enter the number of copies using the arrow or number keypad, if necessary.

5 Press  (**Start**).



If you need to cancel the copying job during the operation, press  (**Stop/Clear**) and the copying will stop.

# Basic copying

## Changing the settings for each copy



Your machine provides default settings for copying so that you can quickly and easily make a copy. However, if you want to change the options for each copy, use the copy function buttons on the control panel.



- If you press  (**Stop/Clear**) while setting the copy options, all of the options you have set for the current copy job will be canceled and returned to their default status. Or, they will automatically return to their default status after the machine completes the copy in progress.
- Accessing menus may differ from model to model (see "Accessing the menu" on page 33).
- It may be necessary to press **OK** to navigate to lower-level menus for some models.

## Darkness



If you have an original containing faint marking and dark images, you can adjust the brightness to make a copy that is easier to read.

- 1 Select  (copy) >  (**Menu**) > **Copy Feature** > **Darkness** on the control panel.  
Or select **Darkness** button on the control panel.

- 2 Select the option you want and press **OK**.  
For example, the **Light+5** being the lightest, and the **Dark+5** being the darkest.
- 3 Press  (**Stop/Clear**) to return to ready mode.

## Original

The original setting is used to improve the copy quality by selecting the document for the current copy job.

- 1 Select  (copy) >  (**Menu**) > **Copy Feature** > **Original Type** on the control panel.  
Or select  (**Menu**) > **Copy Feature** > **Original Type** on the control panel.
- 2 Select the option you want and press **OK**.
  - **Text**: Use for originals containing mostly text.
  - **Text/Photo**: Use for originals with mixed text and photographs.



If texts in the printout is blurry, select **Text** to get the clear texts.

- **Photo**: Use when the originals are photographs.
- 3 Press  (**Stop/Clear**) to return to ready mode.

# Basic copying



## Reduced or enlarged copy

You can reduce or enlarge the size of a copied image from 25% to 400% when you copy original documents from the scanner glass.



- This feature may not be available depending on model or optional goods (see "Variety feature" on page 10).
- If the machine set to Eco mode, reduce and enlarge features are not available.





## To select from the predefined copy sizes

- 1 Select  (copy) >  (**Menu**) > **Copy Feature** > **Reduce/Enlarge** on the control panel.

Or select  (**Menu**) > **Copy Feature** > **Reduce/Enlarge** on the control panel.

- 2 Select the option you want and press **OK**.
- 3 Press  (**Stop/Clear**) to return to ready mode.

## To scale the copy by directly entering the scale rate

- 1 Select  (copy) >  (**Menu**) > **Copy Feature** > **Reduce/Enlarge** > **Custom** on the control panel.  
  
Or select  (**Menu**) > **Copy Feature** > **Reduce/Enlarge** on the control panel.
- 2 Enter the copy size you want using the numeric keypad.
- 3 Press **OK** to save the selection.
- 4 Press  (**Stop/Clear**) to return to ready mode.



When you make a reduced copy, black lines may appear at the bottom of your copy.

# Basic copying

## ID card copying

Your machine can print 2-sided originals on one sheet.

The machine prints one side of the original on the upper half of the paper and the other side on the lower half without reducing the size of the original. This feature is helpful for copying a small-sized item such as business card.



- The original must be placed on the scanner glass to use this feature.
- If the machine set to Eco mode, this feature is not available.

- For better image quality, Select  (**copy**) >  (**Menu**) > **Copy Feature** > **Original Type** > **Photo** on the control panel or  (**Menu**) > **Copy Feature** > **Original Type** > **Photo**.

**1** Press **ID Copy** on the control panel.

**2** Place the front side of an original facing down on the scanner glass where arrows indicate as shown. Then, close the scanner lid.

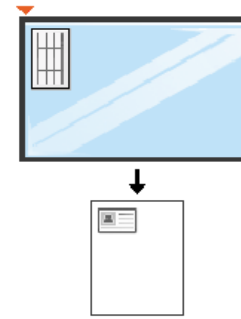

**3** **Place Front Side and Press [Start]** appears on the display.

**4** Press **Start**.

Your machine begins scanning the front side and shows **Place Back Side and Press [Start]**.



- 5 Turn the original over and place it on the scanner glass where arrows indicate as shown. Then, close the scanner lid.

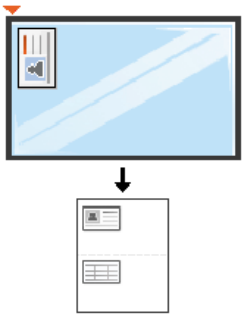

- 6 Press **Start**.



- If you do not press the  (**Start**) button, only the front side will be copied.
- If the original is larger than the printable area, some portions may not be printed.

# Basic scanning



- For special scanning features, refer to the Advanced Guide (see "Scan features" on page 245).
- Depending on models or options, some menus may not be supported (see "Features by model" on page 7).

## Basic Scanning

This is the normal and usual procedure for scanning originals.

This is a basic scanning method for USB-connected machine.



- It may be necessary to press **OK** to navigate to lower-level menus for some models.
- if you want to scan using the network, refer to the Advanced Guide (see "Scanning from network connected machine" on page 250).

**1** Place a single document face down on the document glass, or load the documents face up into the document feeder (see "Loading originals" on page 52).

**2** Select  (**scan**) > **Scan to PC** > **Local PC** on the control panel.  
Or select **Scan to** > **Local PC** on the control panel.



If you see **Not Available** message, check the port connection, or select **Enable Scan from Device Panel** in **Samsung Easy Printer Manager** >



**Switch to advanced mode** > **Scan to PC Settings**.

**3**

Select the application program you want and press **OK**.

Default setting is **My Documents**.



You can add or delete the folder where the scanned file is saved in

**Samsung Easy Printer Manager** >  **Switch to advanced mode**. > **Scan to PC Settings**.

**4**

Select the option you want and press **OK**.

**5**

Scanning begins.



Scanned image is saved in computer's **C:\Users\users name\My**

- **Documents**. The saved folder may differ, depending on your operating system or the application you are using.

# Basic faxing

## Basic faxing



- For special faxing features, refer to the Advanced Guide (See "Fax features" on page 252).
- Accessing menus may differ from model to model (see "Accessing the menu" on page 33 or "Control panel overview" on page 24).
- M267xN/M287xND/M287xDW does not support fax features.
- You cannot use this machine as a fax via the internet phone. For more information ask your internet service provider.
- We recommend using traditional analog phone services (PSTN: Public Switched Telephone Network) when connecting telephone lines to use a fax machine. If you use other Internet services (DSL, ISDN, VoIP), you can improve the connection quality by using the Micro-filter. The Micro-filter eliminates unnecessary noise signals and improves connection quality or Internet quality. Since the DSL Micro-filter is not provided with the machine, contact your Internet service provider for use on DSL Micro-filter.

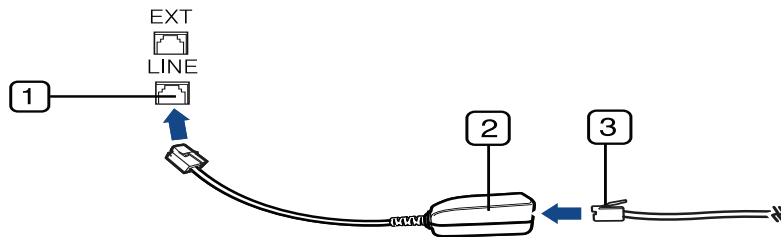

- 1 Line port
- 2 Micro filter
- 3 DSL modem / Telephone line (see "Rear view" on page 23).

## Preparing to fax

Before you send or receive a fax, you need to connect the supplied line cord to your telephone wall jack (see "Rear view" on page 23). Refer to the Quick Installation Guide how to make a connection. The method of making a telephone connection is different from one country to another.

## Sending a fax



When you place the originals, you can use either the document feeder or the scanner glass. If the originals are placed on both the document feeder and the scanner glass, the machine will read the originals on the document feeder first, which has higher priority in scanning.

- 1 Place a single document face down on the document glass, or load the documents face up into the document feeder (see "Loading originals" on page 52).
- 2 Select  (fax) on the control panel.
- 3 Adjust the resolution and the darkness to suit your fax needs (see "Adjusting the document settings" on page 69).
- 4 Enter the destination fax number.

# Basic faxing



- 5 Press  (**Start**) on the control panel. The machine starts to scan and send the fax to the destinations.



- If you want to send a fax directly from your computer, use Samsung Network PC Fax (see "Sending a fax in the computer" on page 253).
- When you want to cancel a fax job, press  (**Stop/Clear**) before the machine starts transmission.
- If you used the scanner glass, the machine shows the message asking to place another page.

## Sending a fax manually

Perform the following to send a fax using  (**On Hook Dial**) on the control panel. If your machine is a handset model, you can send a fax using the handset (see "Features by model" on page 7).

- 1 Place a single document face down on the document glass, or load the documents face up into the document feeder (see "Loading originals" on page 52).
- 2 Select  (fax) on the control panel.
- 3 Adjust the resolution and the darkness to suit your fax needs (see "Adjusting the document settings" on page 69).
- 4 Press  (**On Hook Dial**) on the control panel or lift the handset.

- 5 Enter a fax number using the number keypad on the control panel.



- 6 Press  (**Start**) on the control panel when you hear a high-pitched fax signal from the remote fax machine.

## Sending a fax to multiple destinations

You can use the multiple send feature, which allows you to send a fax to multiple locations. Originals are automatically stored in memory and sent to a remote station. After transmission, the originals are automatically erased from memory (see "Features by model" on page 7).



You cannot send faxes with this feature if you have chosen super fine as an option or if the fax is in color.

- 1 Place a single document face down on the document glass, or load the documents face up into the document feeder (see "Loading originals" on page 52).
- 2 Select  (fax) on the control panel.
- 3 Adjust the resolution and the darkness to suit your fax needs (see "Adjusting the document settings" on page 69).
- 4 Select  (**Menu**) > **Fax Feature** > **Multi Send** on the control panel.

# Basic faxing

- 5 Enter the number of the first receiving fax machine and press **OK**.  
You can press speed dial numbers or select a group dial number using the  (**Address book**) button.
- 6 Enter the second fax number and press **OK**.  
The display asks you to enter another fax number to send the document.
- 7 To enter more fax numbers, press **OK** when **Yes** appears and repeat steps 5 and 6. You can add up to 10 destinations.



Once you have entered a group dial number, you cannot enter another group dial number.

- 8 When you have finished entering fax numbers, select **No** at the **Another No.?** prompt and press **OK**.  
The machine begins sending the fax to the numbers you entered in the order in which you entered them.

## Receiving a fax

Your machine is preset to Fax mode at the factory. When you receive a fax, the machine answers the call on a specified number of rings and automatically receives the fax.

## Adjusting the document settings



Before starting a fax, change the following settings according to your original's status to get the best quality.



- Accessing menus may differ from model to model (see "Accessing the menu" on page 33 or "Control panel overview" on page 24).
- It may be necessary to press **OK** to navigate to lower-level menus for some models.

## Resolution

The default document settings produce good results when using typical text-based originals. However, if you send originals that are of poor quality, or contain photographs, you can adjust the resolution to produce a higher quality fax.

- 1 Select  (fax) >  (**Menu**) > **Fax Feature** > **Resolution** on the control panel.
- 2 Select the option you want and press **OK**.
  - **Standard**: Originals with normal sized characters.
  - **Fine**: Originals containing small characters or thin lines or originals printed using a dot-matrix printer.

# Basic faxing

- **Super Fine:** Originals containing extremely fine detail. **Super Fine** mode is enabled only if the machine with which you are communicating also supports the Super Fine resolution.



- For memory transmission, **Super Fine** mode is not available. The resolution setting is automatically changed to **Fine**.
- When your machine is set to **Super Fine** resolution and the fax machine with which you are communicating does not support **Super Fine** resolution, the machine transmits using the highest resolution mode supported by the other fax machine.

- **Photo Fax:** Originals containing shades of gray or photographs.
- **Color Fax:** Original with colors.



- Memory transmission is not available in this mode.
- You can only send a color fax if the machine you are communicating with supports color fax reception and you send the fax manually.

- 3 Press (Stop/Clear) to return to ready mode.

## Darkness

You can select the degree of darkness of the original document.



The darkness setting is applied to the current fax job. To change the default setting (see "Fax menu" on page 214).

- 1 Select (fax) > (Menu) > **Fax Feature** > **Darkness** on the control panel.
- 2 Select a darkness level you want.
- 3 Press (Stop/Clear) to return to ready mode.



# 3. Maintenance

This chapter provides information about purchasing supplies, accessories and maintenance parts available for your machine.

- **Ordering supplies and accessories** 71
- **Available supplies** 72
- **Available maintenance parts** 73
- **Storing the toner cartridge** 74
- **Redistributing toner** 76
- **Replacing the toner cartridge** 79
- **Replacing the imaging unit** 82
- **Monitoring the supplies life** 84
- **Setting the toner low alert** 85
- **Cleaning the machine** 86
- **Tips for moving & storing your machine** 93

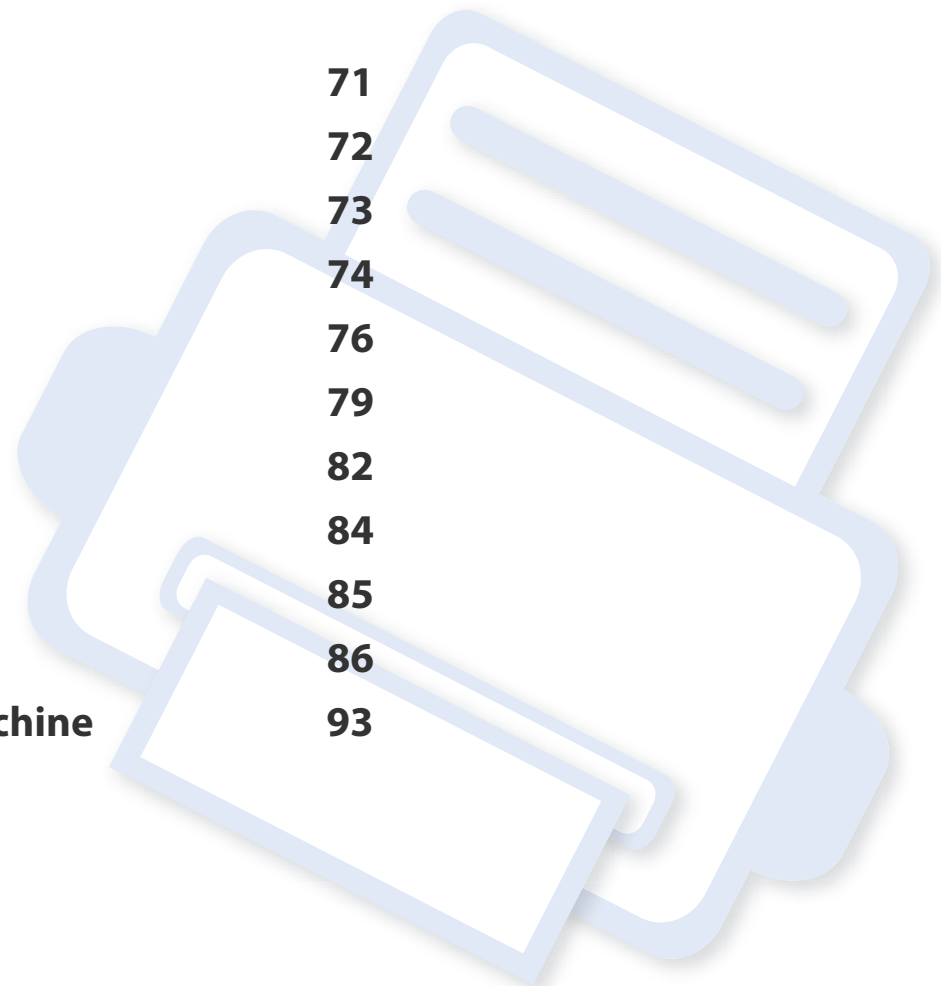

# Ordering supplies and accessories



Available accessories may differ from country to country. Contact your sales representatives to obtain the list of available supplies, and maintenance parts.

To order Samsung-authorized supplies, accessories, and maintenance parts, contact your local Samsung dealer or the retailer where you purchased your machine. You can also visit [www.samsung.com/supplies](http://www.samsung.com/supplies), and then select your country/region to obtain the contact information for service.



# Available supplies

When supplies reach the end of their life spans, you can order the following s of supplies for your machine:

Type	Model	Average yield <sup>a</sup>	Part name
Toner cartridge	M2670/M2671/M2870/M2880 series	Approx. 3,000 pages	MLT-D115L
	M2675/M2676/M2875/M2876/M2885/ M2886 series	Approx. 1,200 pages	MLT-D116S <sup>b</sup>
		Approx. 3,000 pages	MLT-D116L
Imaging Unit	M2675/M2676/M2875/M2876/M2885/ M2886 series	Approx. 9,000 pages	MLT-R116

a. Declared yield value in accordance with ISO/IEC 19752.

b. Not supported for India.

# Available maintenance parts

You need to replace the maintenance parts at specific intervals to keep the machine in the best condition and avoid print quality and paper feeding problems resulting from the worn-out parts. Maintenance parts are mostly rollers, belts and pads. However, the replacement period and parts may differ depending on the model. Replacing maintenance parts can be performed only by an authorized service provider, dealer, or the retailer where you bought the machine. To purchase maintenance parts, contact the retailer where you bought the machine. The replacement period for the maintenance parts is informed by the Samsung Printer Status program. Or if your machine supports display screen, a message is displayed in the display screen. The replacement period varies based on the operating system used, computing performance, application software, connecting method, paper type, paper size, and job complexity.

# Storing the toner cartridge

Toner cartridges contain components that are sensitive to light, temperature and humidity. Samsung suggests users follow these recommendations to ensure optimal performance, highest quality, and longest life from your new Samsung toner cartridge.

Store the cartridge in the same environment in which the printer will be used. This should be in controlled temperature and humidity conditions. The toner cartridge should remain in their original and unopened package until installation – if original packaging is not available, cover the top opening of the cartridge with paper and store in a dark cabinet.

Opening the cartridge package prior to use dramatically shortens its useful shelf and operating life. Do not store on the floor. If the toner cartridge is removed from the printer, follow the instructions below to store the toner cartridge properly.

- Store the cartridge inside the protective bag from the original package.
- Store lying flat (not standing on end) with the same side facing up as if it were installed in the machine.
- Do not store consumables in any of the following conditions:
  - Temperature greater than 40°C (104°F).
  - Humidity range less than 20% or greater than 80%.
  - An environment with extreme changes in humidity or temperature.
  - Direct sunlight or room light.
  - Dusty places.
  - A car for a long period of time.
  - An environment where corrosive gases are present.

- An environment with salty air.

## Handling instructions

- Do not touch the surface of the photoconductive drum in the cartridge.
- Do not expose the cartridge to unnecessary vibrations or shock.
- Never manually rotate the drum, especially in the reverse direction; this can cause internal damage and toner spillage.

## Toner cartridge usage

Samsung Electronics does not recommend or approve the use of non-Samsung brand toner cartridges in your printer including generic, store brand, refilled, or remanufactured toner cartridges.



Samsung's printer warranty does not cover damage to the machine caused by the use of refilled, remanufactured, or non-Samsung brand toner cartridges.

# Storing the toner cartridge

## Estimated cartridge life

Estimated cartridge life (the life of the toner cartridge yield) depends on the amount of toner that print jobs require. The actual print yield may vary depending on the print density of the pages you print on, operating environment, percentage of image area, printing interval, media type and/or media size. For example, if you print a lot of graphics, the consumption of the toner is higher and you may need to change the cartridge more often.

# Redistributing toner

When the toner cartridge is near the end of its life:

- White streaks or light printing occurs and/or density varies from side to side.
- The **Status** LED blinks red.

If this happens, you can temporarily improve print quality by redistributing the remaining toner in the cartridge. In some cases, white streaks or light printing will still occur even after you have redistributed the toner.



- Illustrations on this user's guide may differ from your machine depending on its options or models. Check your machine type (see "Machine overview" on page 21).
- If toner gets on your clothing, wipe it off with a dry cloth and wash clothing in cold water: hot water sets toner into fabric.



- To prevent damage to the toner cartridge, do not expose it to light for more than a few minutes. Cover it with a piece of paper, if necessary.
- Do not touch the green area of the toner cartridge. Use the handle on the cartridge to avoid touching this area.
- Do not use sharp objects such as a knife or scissors to open the toner cartridge package. They might scratch the drum of the cartridge.
- If toner gets on your clothing, wipe it off with a dry cloth and wash clothing in cold water. Hot water sets toner into fabric.

# Redistributing toner

M2670/M2671/M2870/M2880 series

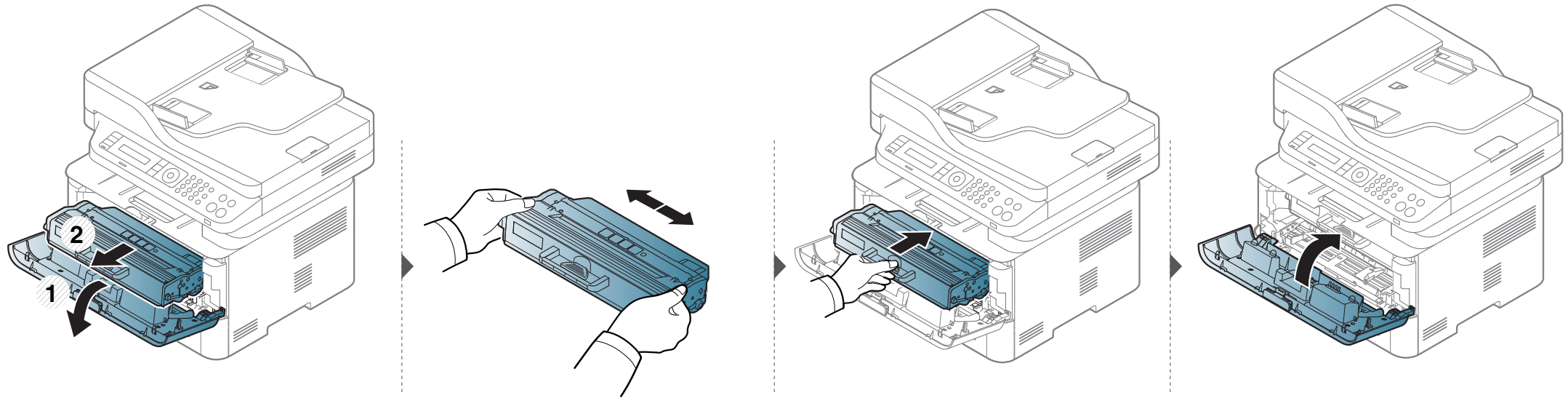

# Redistributing toner

M2675/M2676/M2875/M2876/M2885/M2886 series

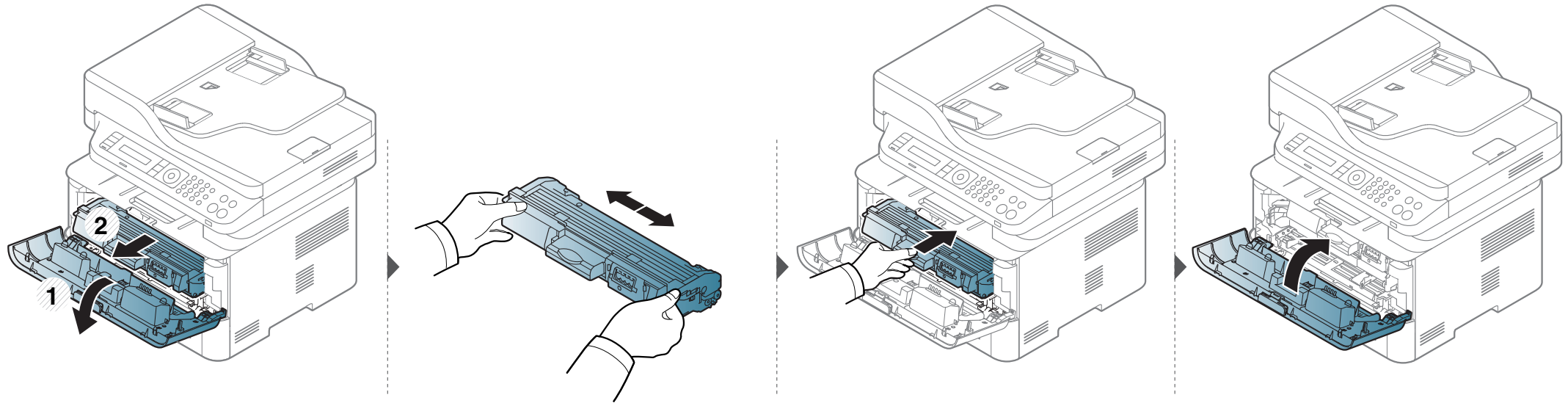

# Replacing the toner cartridge



- Shake the toner cartridge thoroughly, it will increase the initial print quality.
- Illustrations on this user's guide may differ from your machine depending on its options or models. Check your machine type (see "Front view" on page 22).



- To prevent damage to the toner cartridge, do not expose it to light for more than a few minutes. Cover it with a piece of paper, if necessary.
- Do not touch the green area of the toner cartridge. Use the handle on the cartridge to avoid touching this area.
- Do not use sharp objects such as a knife or scissors to open the toner cartridge package. They might scratch the drum of the cartridge.
- If toner gets on your clothing, wipe it off with a dry cloth and wash clothing in cold water. Hot water sets toner into fabric.



# Replacing the toner cartridge

## M2670/M2671/M2870/M2880 series

When a toner cartridge has reached the end of life, the machine will stop printing.

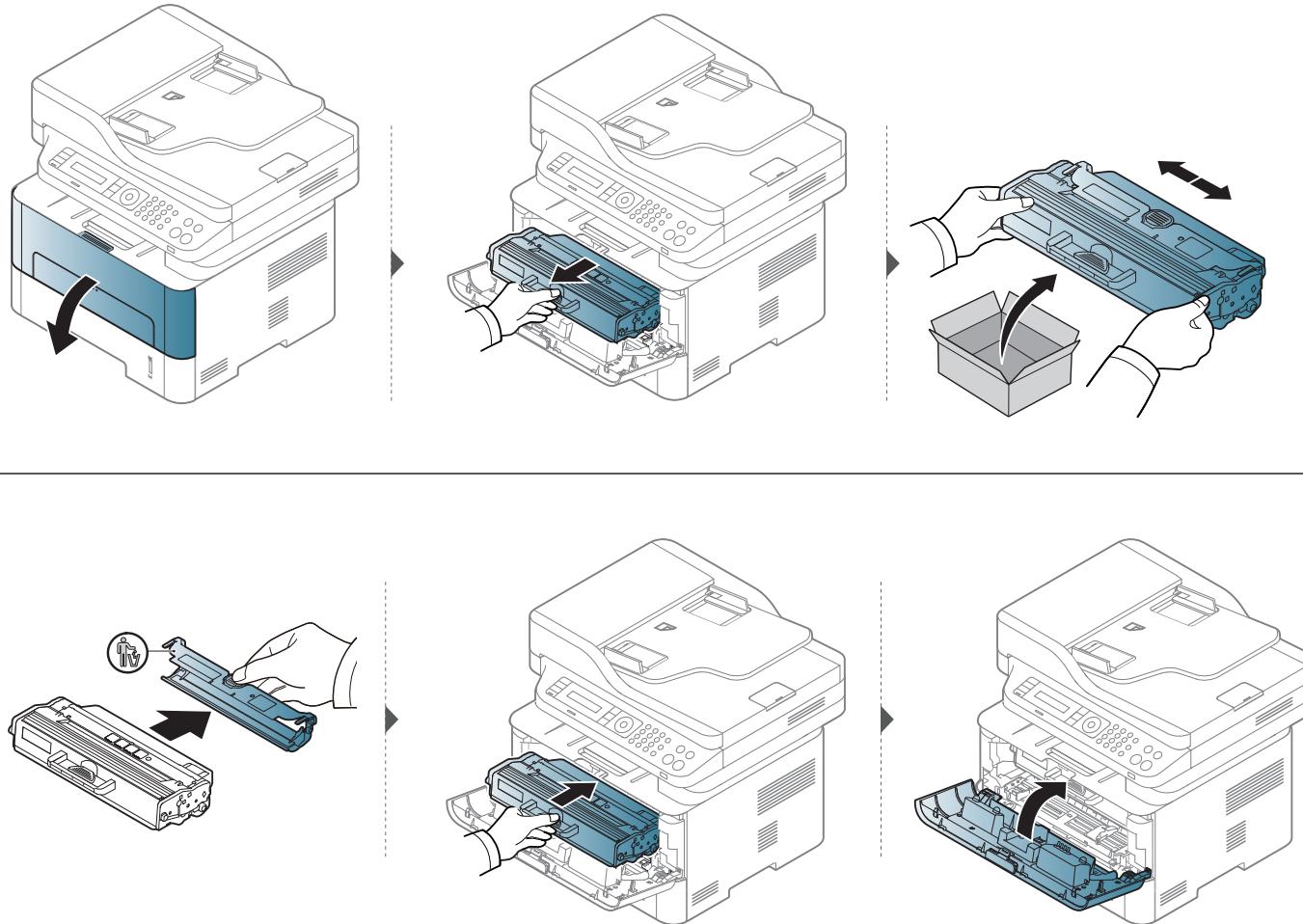

# Replacing the toner cartridge

M2675/M2676/M2875/M2876/M2885/M2886 series

When a toner cartridge has reached the end of life, the machine will stop printing.

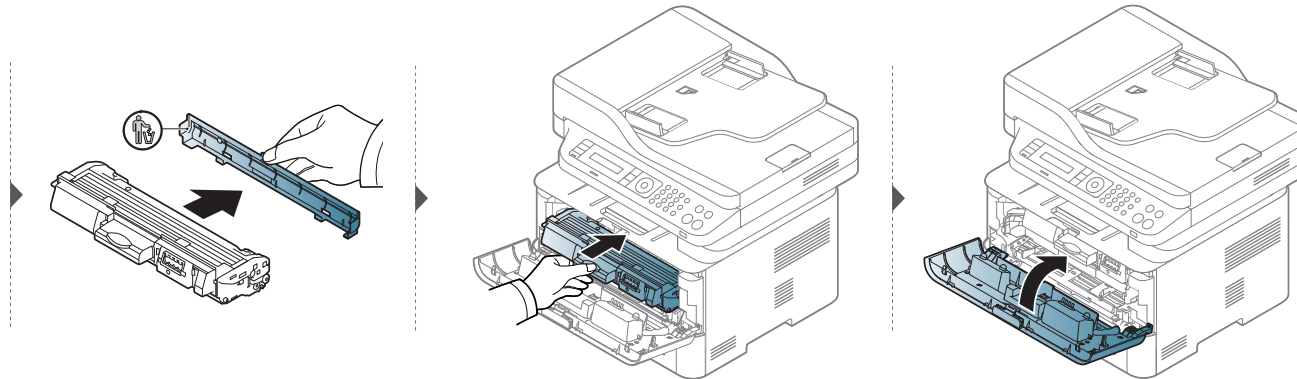
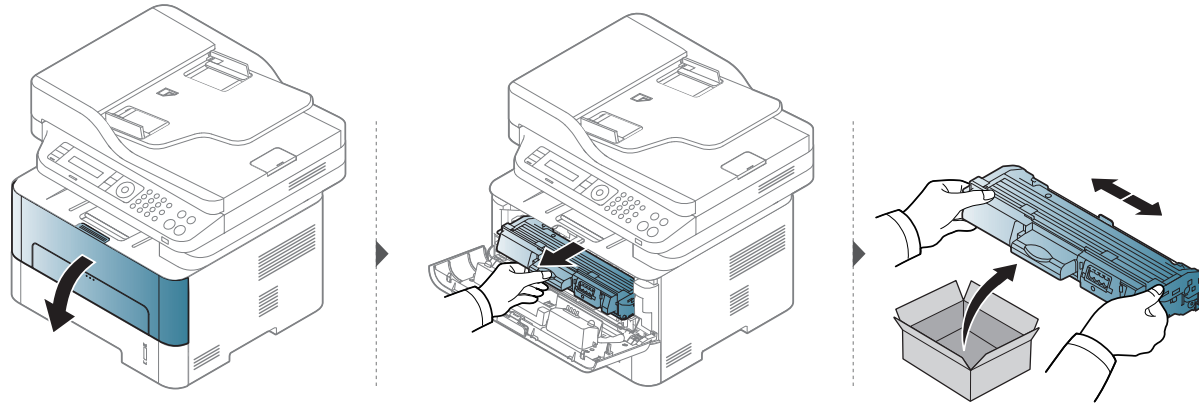

# Replacing the imaging unit

When a imaging unit has reached the end of life, the machine will stop printing.



- To prevent damage to the toner cartridge, do not expose it to light for more than a few minutes. Cover it with a piece of paper, if necessary.
- Do not touch the green area of the toner cartridge. Use the handle on the cartridge to avoid touching this area.
- Do not use sharp objects such as a knife or scissors to open the toner cartridge package. They might scratch the drum of the cartridge.
- If toner gets on your clothing, wipe it off with a dry cloth and wash clothing in cold water. Hot water sets toner into fabric.

# Replacing the imaging unit

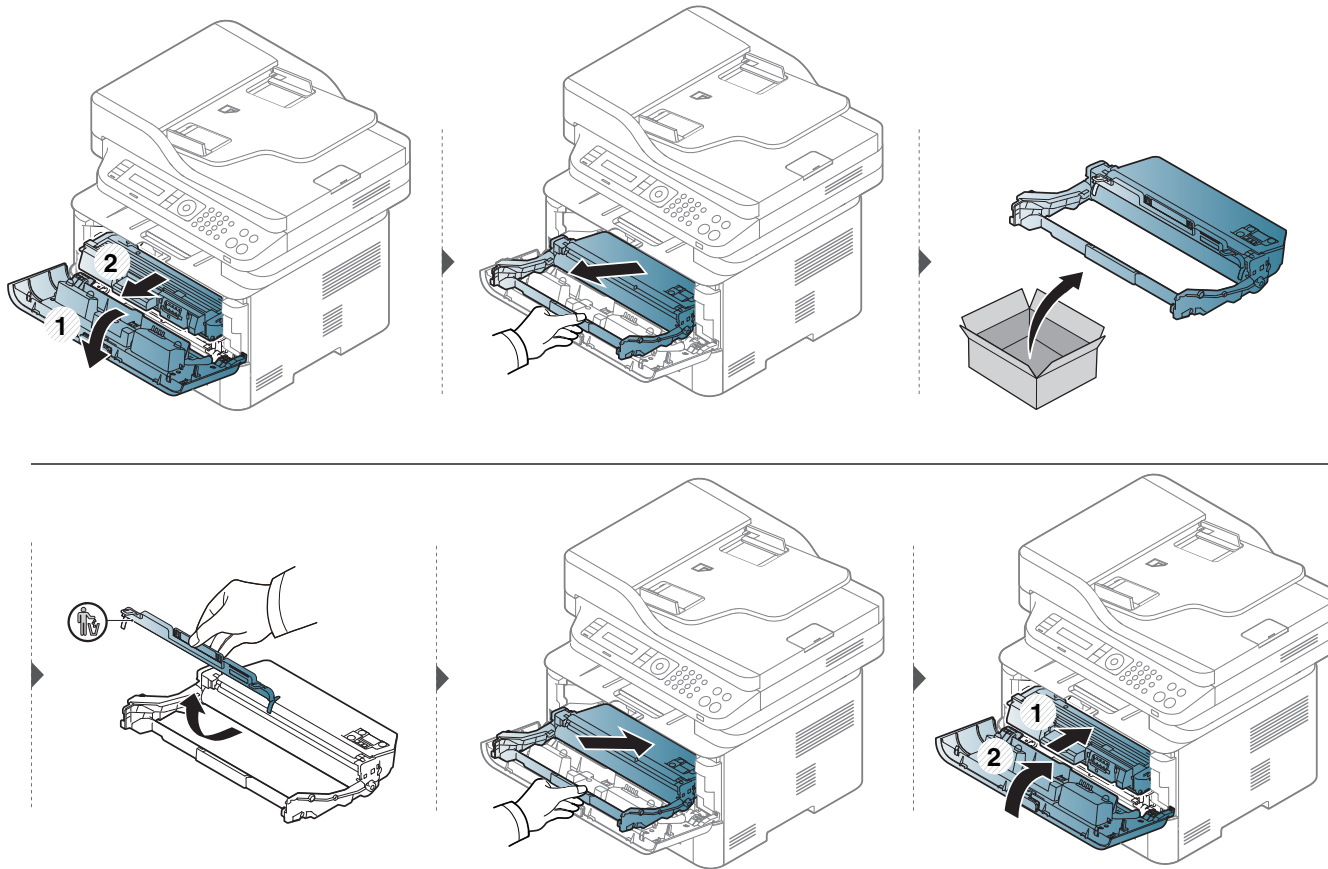

M2675/M2676/M2875/M2876/M2885/M2886 series



# Monitoring the supplies life

If you experience frequent paper jams or printing problems, check the number of pages the machine has printed or scanned. Replace the corresponding parts, if necessary.

 It may be necessary to press **OK** to navigate to lower-level menus for some models.

- 1 Select  (**Menu**) > **System Setup** > **Maintenance** > **Supplies Life** on the control panel.
- 2 Select the option you want and press **OK**.
- 3 Press  (**Stop/Clear**) to return to ready mode.

# Setting the toner low alert

If the amount of toner in the cartridge is low, a message or LED informing the user to change the toner cartridge appears. You can set the option for whether or not this message or LED appears.



- Accessing menus may differ from model to model (see "Accessing the menu" on page 33).
- It may be necessary to press **OK** to navigate to lower-level menus for some models.
- You can set the machine's settings by using the **Device Settings** in Samsung Easy Printer Manager program.
  - For Windows and Mac users, you set from **Samsung Easy Printer Manager** >  **(Switch to advanced mode)** > **Device Settings**.

- 1 Select  **(Menu)** > **System Setup** > **Maintenance** > **TonerLowAlert** on the control panel.
- 2 Select the option you want.
- 3 Press **OK** to save the selection.

# Cleaning the machine

If printing quality problems occur or if you use your machine in a dusty environment, you need to clean your machine regularly to keep it in the best printing condition and use your machine longer.



- Cleaning the cabinet of the machine with cleaning materials containing large amounts of alcohol, solvents, or other strong substances can discolor or distort the cabinet.
- If your machine or the surrounding area is contaminated with toner, we recommend you use a cloth or tissue dampened with water to clean it. If you use a vacuum cleaner, toner blows in the air and might be harmful to you.
- During the printing process, paper, toner, and dust particles can accumulate inside the machine. This buildup can cause print quality problems, such as toner specks or smearing. Cleaning the inside of the machine clears and reduces these problems.

## Cleaning the outside or the display screen

Clean the machine cabinet or the display screen with a soft, lint-free cloth. Dampen the cloth slightly with water, but be careful not to let any water drip onto or into the machine.

# Cleaning the machine

## Cleaning the inside

During the printing process, paper, toner, and dust particles can accumulate inside the machine. This buildup can cause print quality problems, such as toner specks or something. Cleaning the inside of the machine clears and reduces these problems.



- To prevent damage to the toner cartridge, do not expose it to light for more than a few minutes. Cover it with a piece of paper, if necessary.
- Do not touch the green area of the toner cartridge. Use the handle on the cartridge to avoid touching this area.
- Use a dry lint free cloth when cleaning the inside of the machine, be careful not to damage the transfer roller or any other inside parts. Do not use solvents such as benzene or thinner. Printing quality problems can occur and cause damage to the machine.



- Use a dry lint-free cloth to clean the machine.
- Turn the machine off and unplug the power cord. Wait for the machine to cool down. If your machine has a power switch, turn the power switch off before cleaning the machine.
- Before opening the front cover, close the output support first.
- Illustrations on this user's guide may differ from your machine depending on its options or models. Check your machine type (see "Machine overview" on page 21).



# Cleaning the machine

M2670 series  
M2671 series  
M2870 series  
M2880 series

M2675 series  
M2676 series  
M2875 series  
M2876 series  
M2885 series  
M2886 series

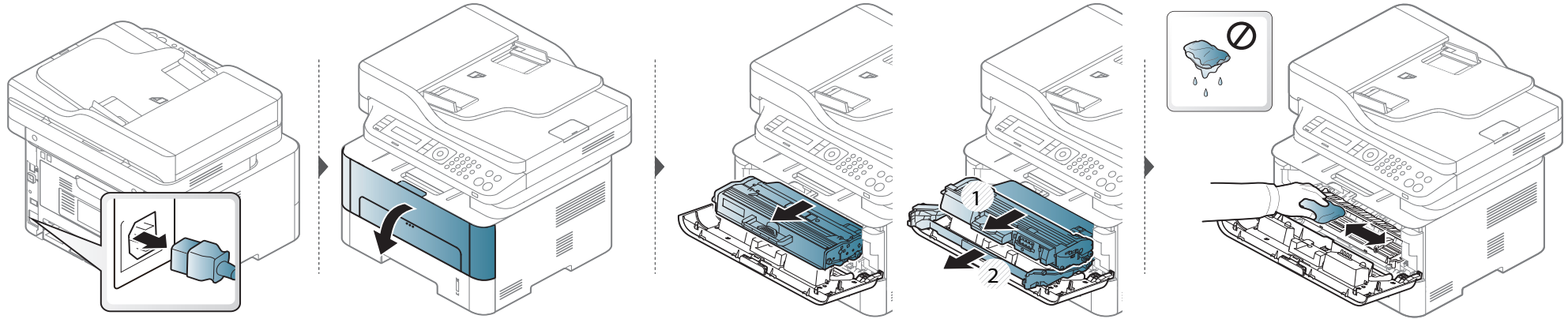

M2670 series  
M2671 series  
M2870 series  
M2880 series

M2675 series  
M2676 series  
M2875 series  
M2876 series  
M2885 series  
M2886 series

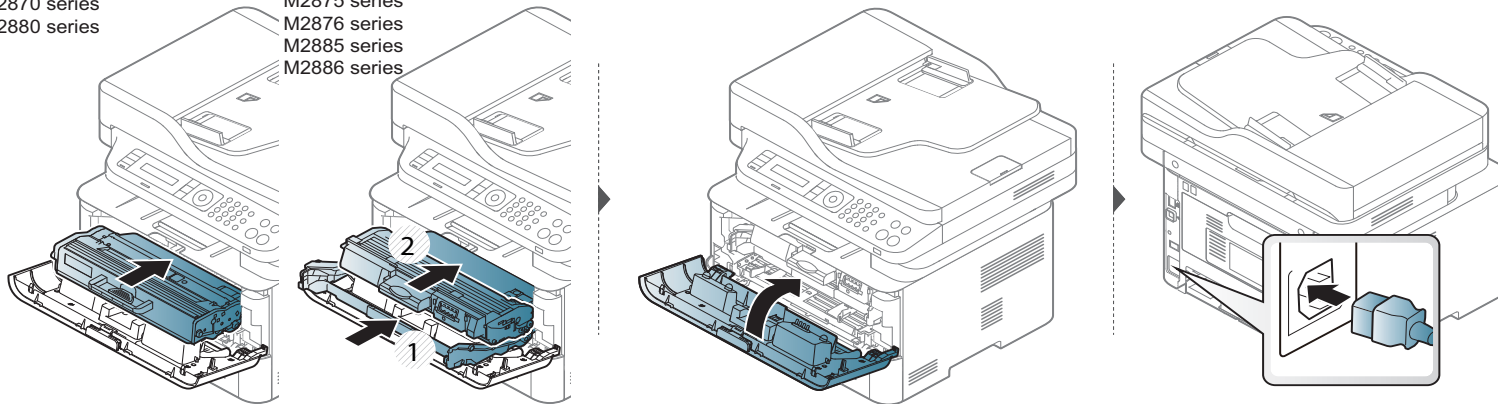

# Cleaning the machine

## Cleaning the pickup roller



- Before opening the front cover, close the output support first.
- Turn the machine off and unplug the power cord. Wait for the machine to cool down. If your machine has a power switch, turn the power switch before cleaning the machine.
- Illustrations on this user's guide may differ from your machine depending on its options or models. Check your machine type (see "Machine overview" on page 21).

# Cleaning the machine

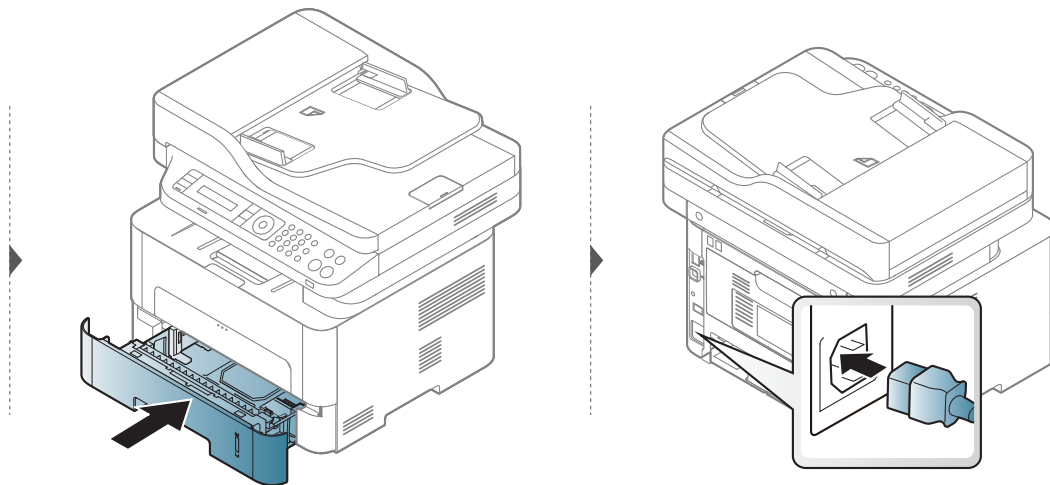
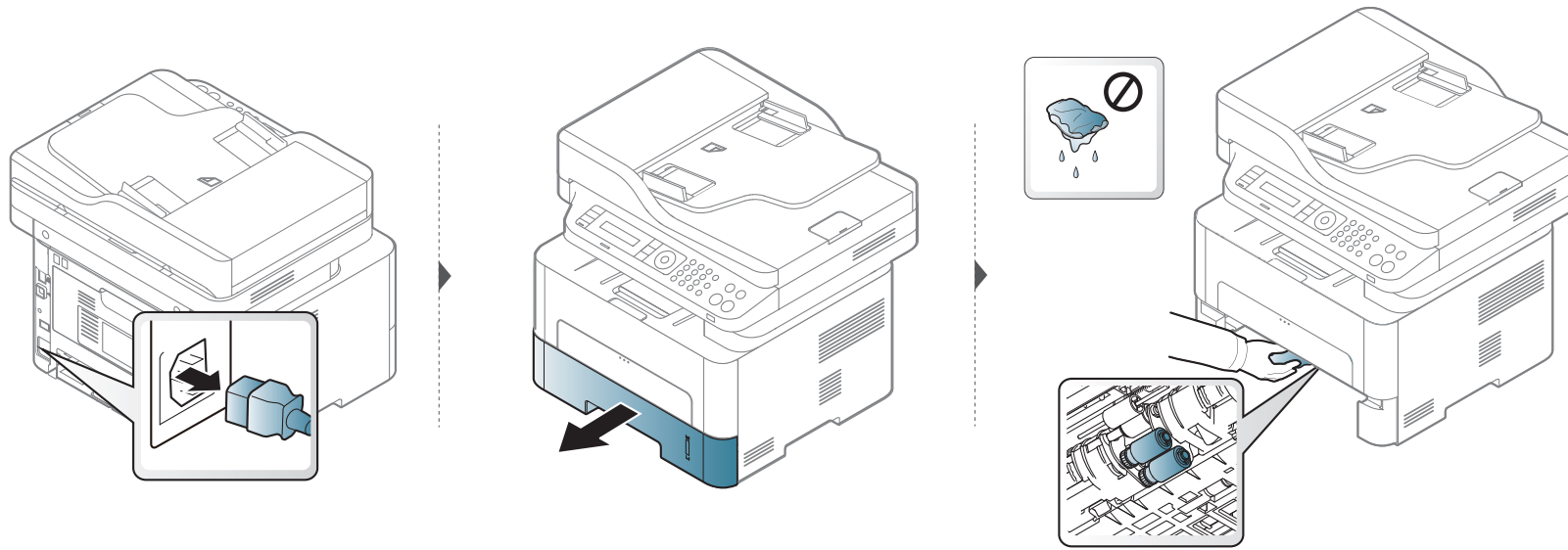

# Cleaning the machine

## Cleaning the scan unit

Keeping the scan unit clean helps ensure the best possible copies. We suggest that you clean the scan unit at the start of each day and during the day as needed.



- Turn the machine off and unplug the power cord. Wait for the machine to cool down. If your machine has a power switch, turn the power switch off before cleaning the machine.
- Illustrations on this user's guide may differ from your machine depending on its options or models. Check your machine type (see "Machine overview" on page 21).

- 1 Slightly dampen a soft, lint-free cloth or paper towel with water.
- 2 Lift and open the scanner lid.
- 3 Wipe the surface of the scanner glass until it is clean and dry.

# Cleaning the machine

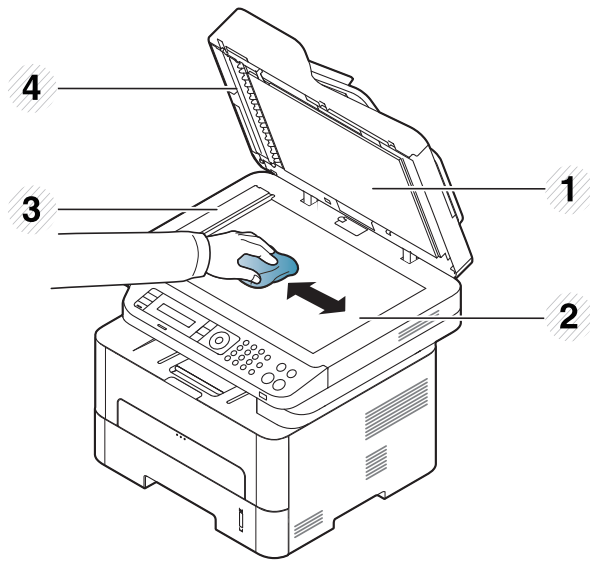

- 1 Scanner lid
- 2 Scanner glass
- 3 Document feeder glass
- 4 White bar

- 4 Wipe the underside of the scanner lid and white sheet until it is clean and dry.
- 5 Close the scanner lid.

# Tips for moving & storing your machine

- When moving the machine, do not tilt or turn it upside down. Otherwise, the inside of the machine may be contaminated by toner, which can cause damage to the machine or reduce print quality.
- When moving the machine, make sure at least two people are holding the machine securely.



# 4. Troubleshooting

This chapter gives helpful information for what to do if you encounter an error.

- **Tips for avoiding paper jams** 95
- **Clearing original document jams** 96
- **Clearing paper jams** 99
- **Understanding the status LED** 107
- **Understanding display messages** 110



This chapter gives helpful information for what to do if you encounter an error. If your machine has a display screen, check the message on the display screen first to solve the error.

If you cannot find a solution to your problem in this chapter, refer to the **Troubleshooting** chapter in the Advanced User's Guide (see "Troubleshooting" on page 281).

If you cannot find a solution in the User's Guide or the problem persists, call for service.

# Tips for avoiding paper jams

By selecting the correct medias, most paper jams can be avoided. To avoid paper jams, refer to the following guidelines:

- Ensure that the adjustable guides are positioned correctly (see "Tray overview" on page 40).
- Do not overload the tray. Ensure that the paper level is below the paper capacity mark on the inside of the tray.
- Do not remove paper from the tray while your machine is printing.
- Flex, fan, and straighten paper before loading.
- Do not use creased, damp, or highly curled paper.
- Do not mix paper type and size in a tray.
- Use only recommended print media (see "Print media specifications" on page 118).



# Clearing original document jams

When an original document jams in the document feeder, a warning message appears on the display.

 To avoid tearing the document, remove the jammed document slowly and carefully.

 To prevent document jams, use the scanner glass for thick, thin or mixed paper- originals.

## Original paper jam in front of scanner

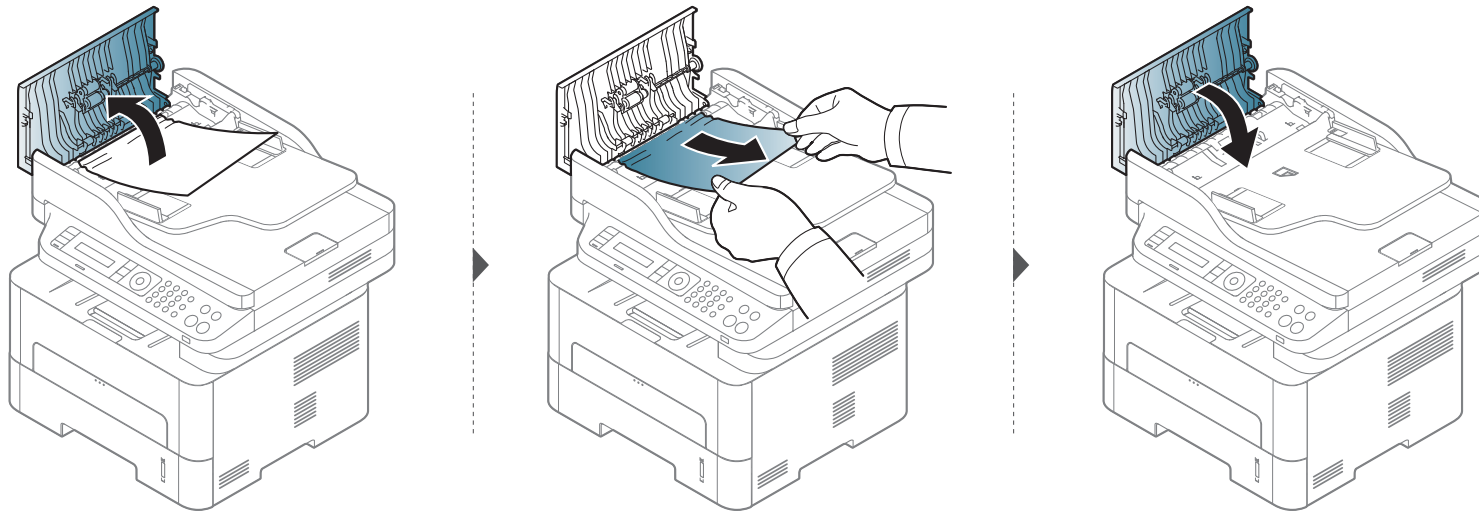

# Clearing original document jams

## Original paper jam inside of scanner

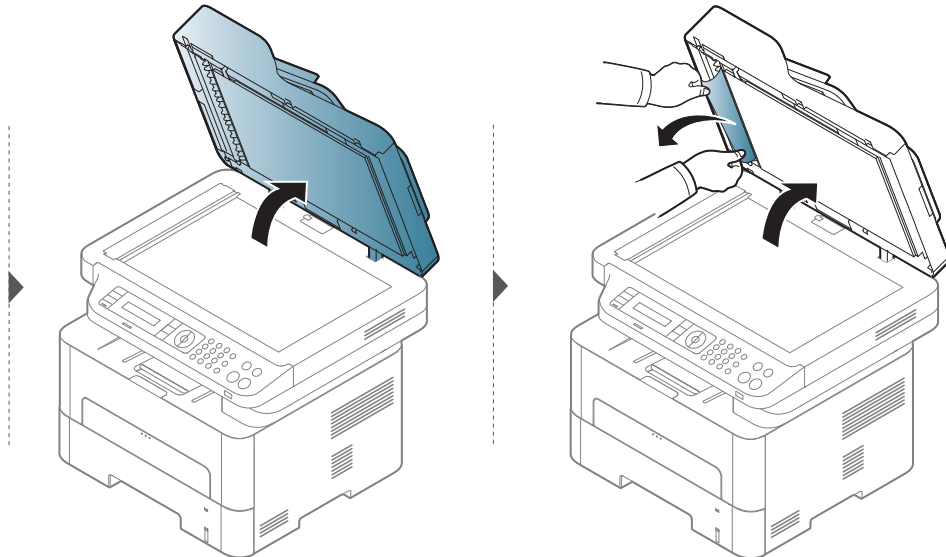
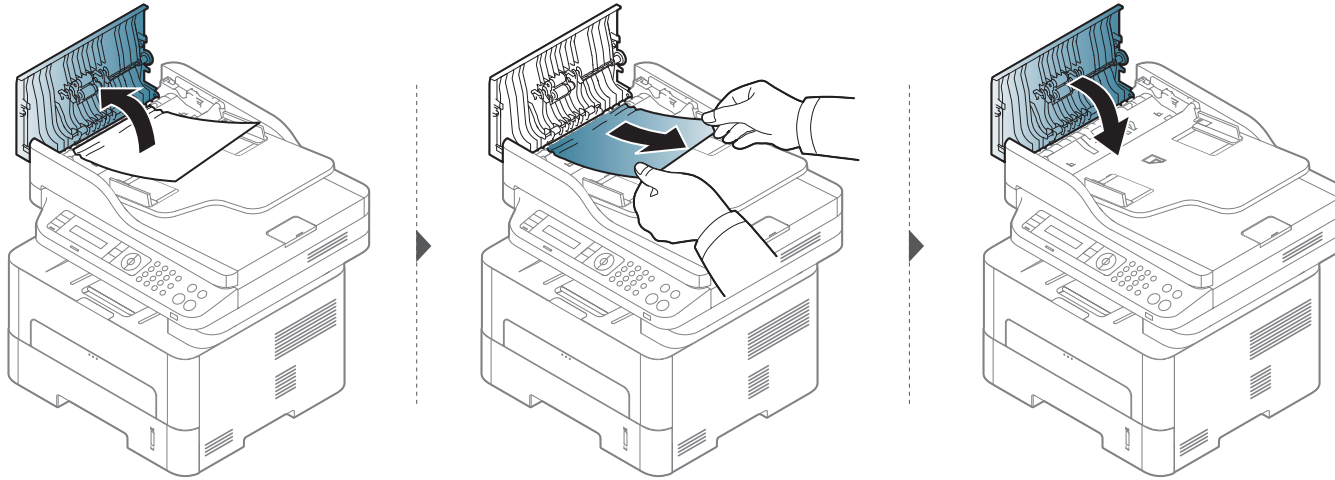

# Clearing original document jams

## Original paper jam in exit area of scanner

- 1 Remove any remaining pages from the document feeder.
- 2 Gently remove the jammed paper from the document feeder.

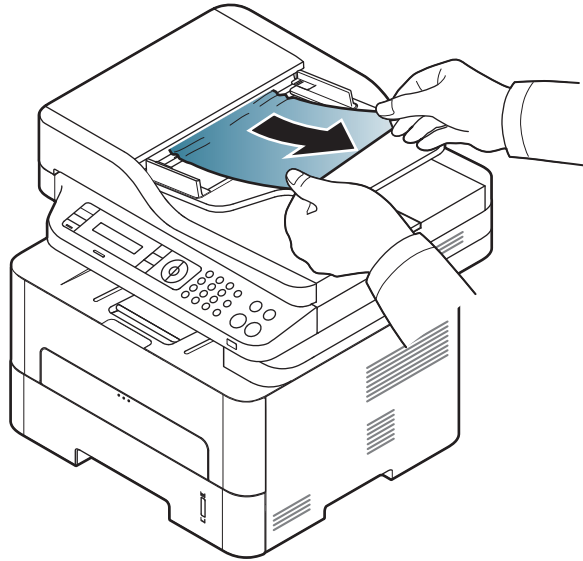

# Clearing paper jams



To avoid tearing the paper, pull the jammed paper out slowly and gently.

## In tray

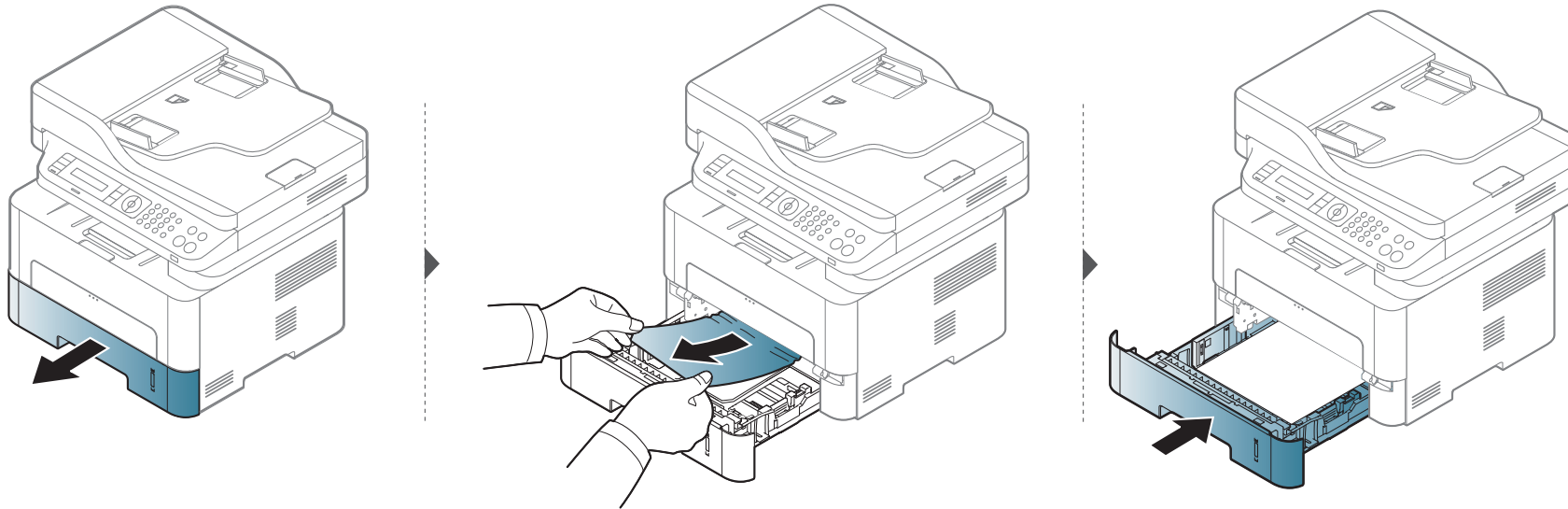

# Clearing paper jams

## In the manual tray

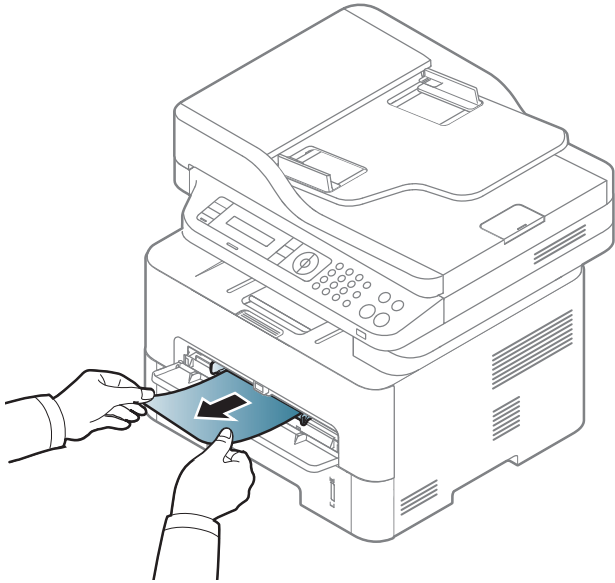

# Clearing paper jams

## Inside the machine



The fuser area is hot. Take care when removing paper from the machine.

# Clearing paper jams

M2670/M2671/M2870/M2880 series

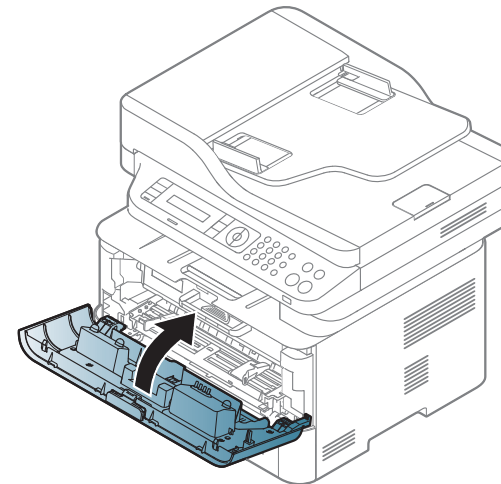
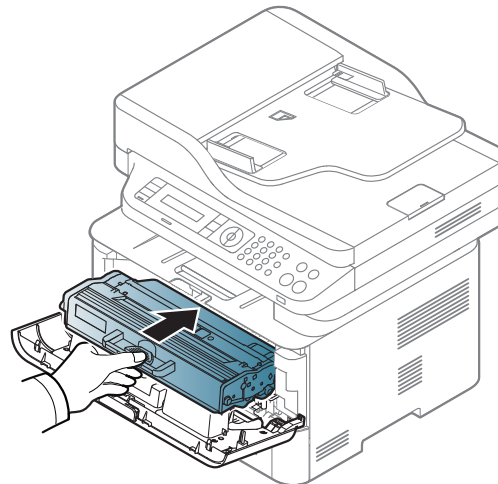
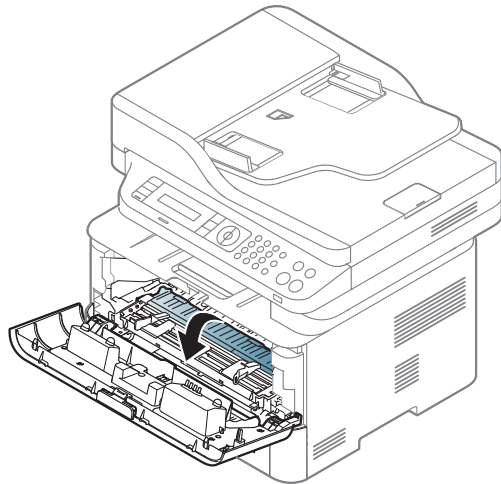
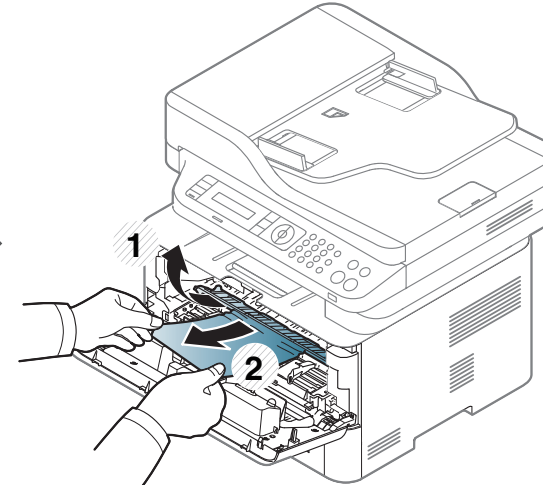
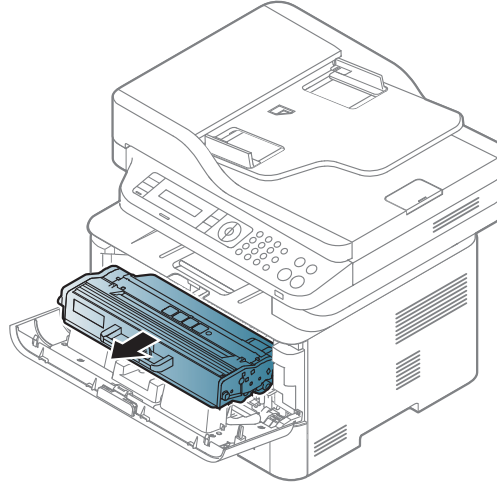
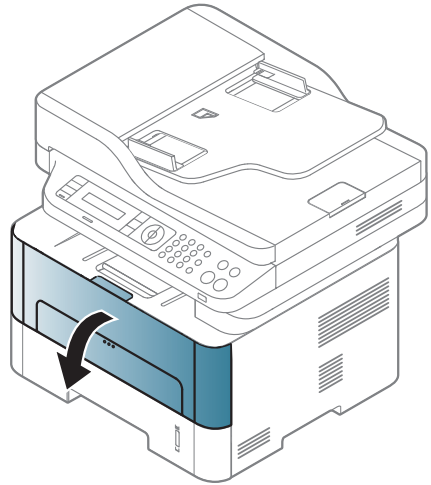

# Clearing paper jams

M2675/M2676/M2875/M2876/M2885/M2886 series

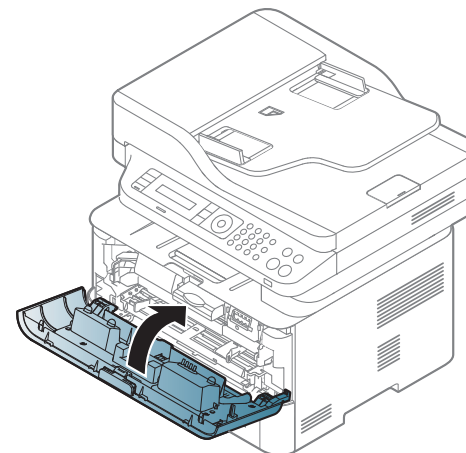
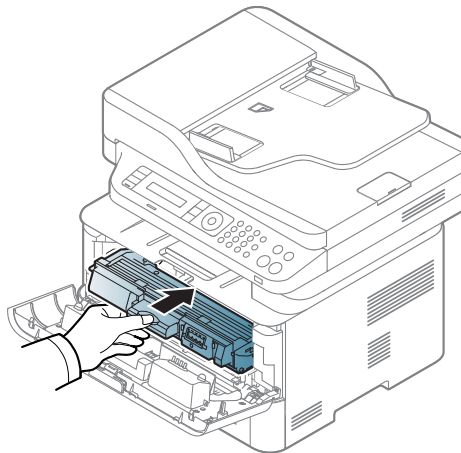
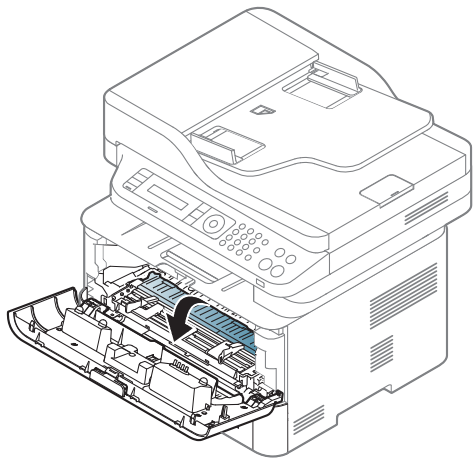
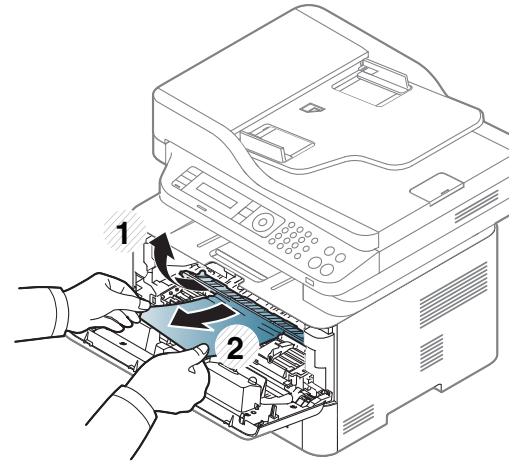
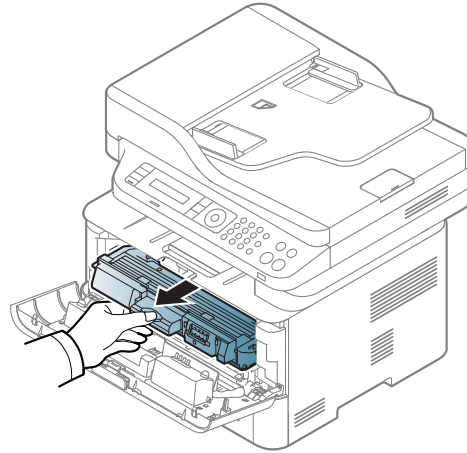
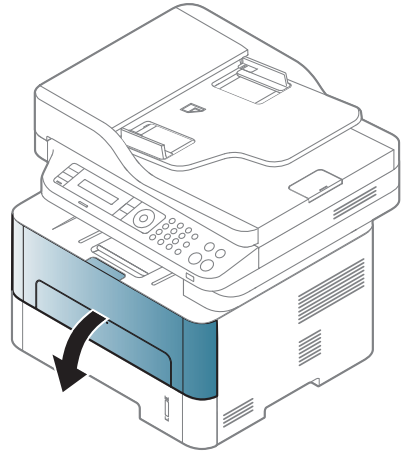



# Clearing paper jams

## In the exit area

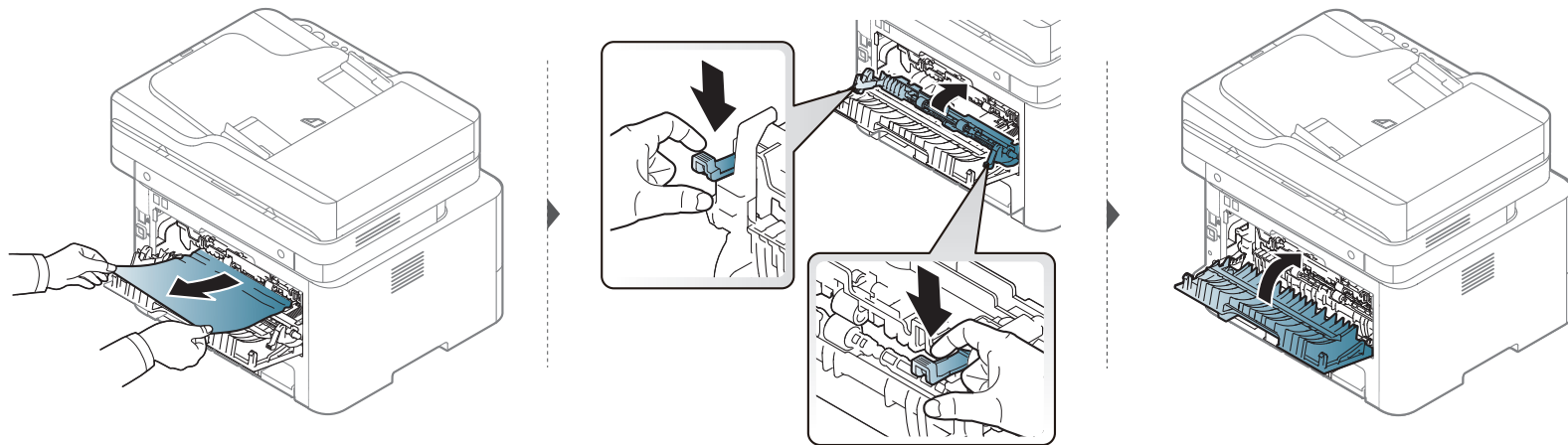
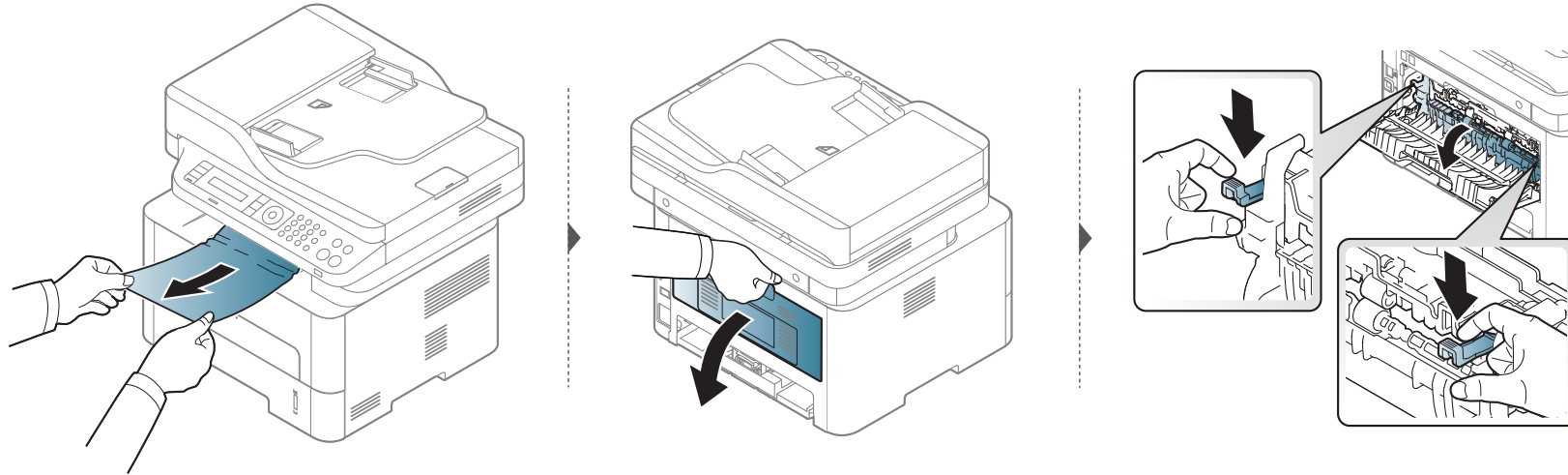

# Clearing paper jams

In the duplex unit area

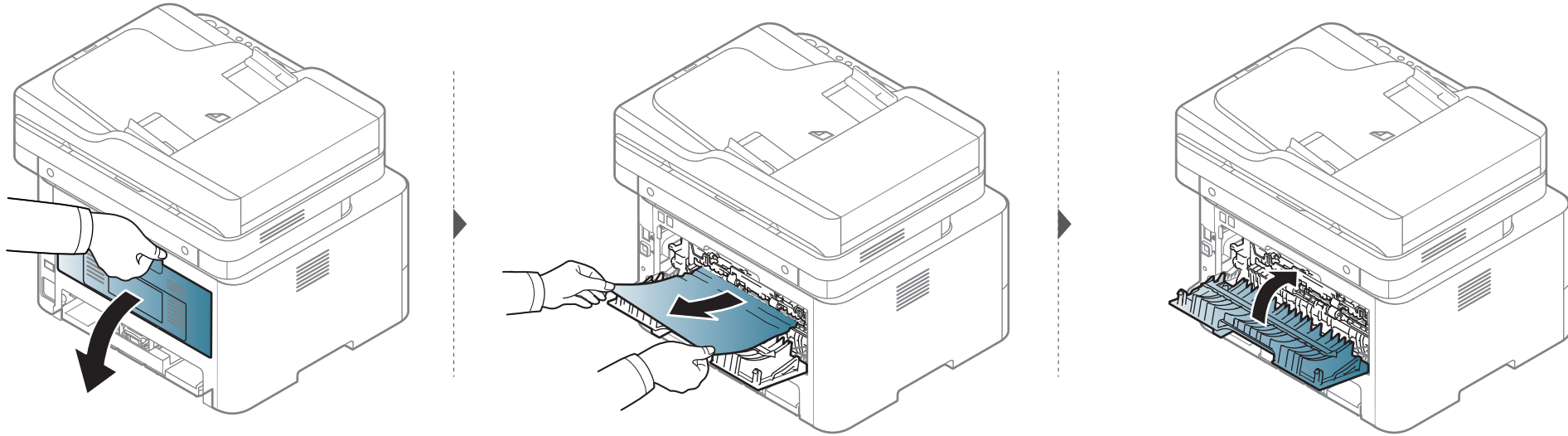

# Clearing paper jams

If you do not see the paper in this area, stop and go to next step:

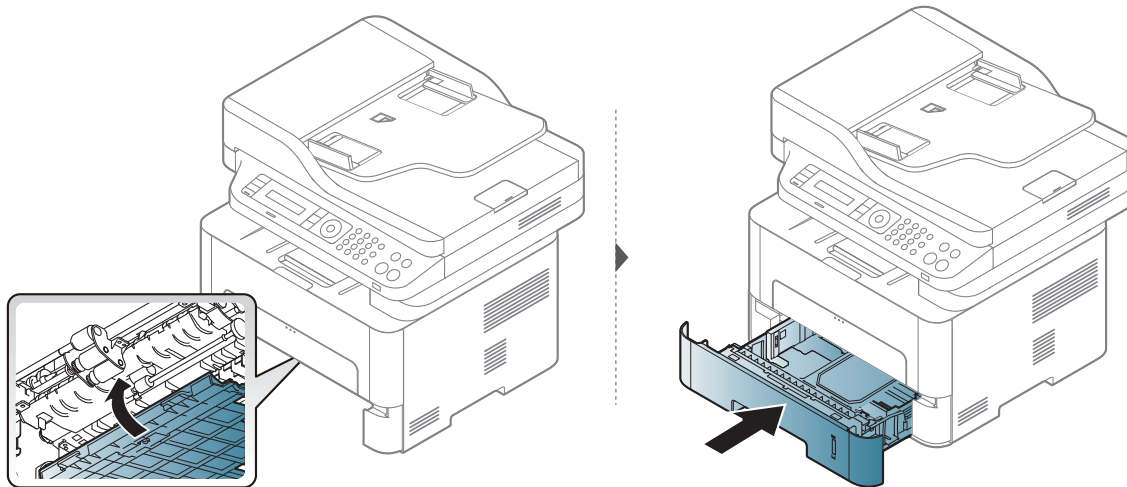
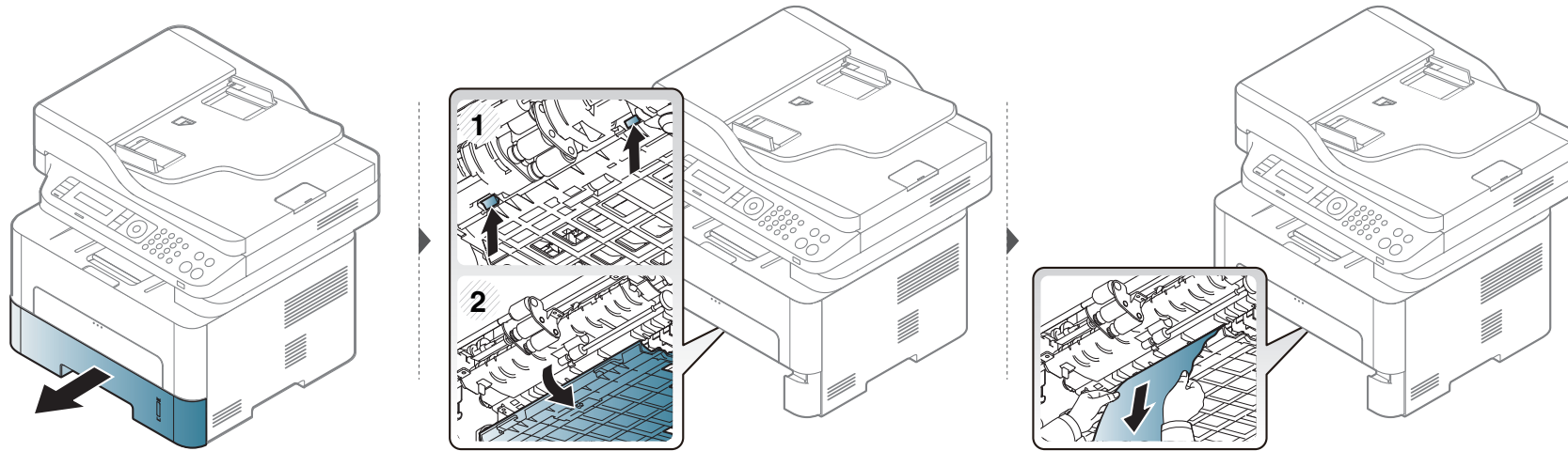

# Understanding the status LED

The color of the LED indicates the machine's current status.



- Some LEDs may not be available depending on model or country.
- To resolve the error, look at the error message and its instructions from the troubleshooting part.
- You also can resolve the error with the guideline from the computer's Printing Status or Smart Panel program window.
- If the problem persists, call a service representative.

# Understanding the status LED

Status		Description	
Status	Off	<ul style="list-style-type: none"> <li>The machine is off-line.</li> <li>The machine is in a power save mode.</li> </ul>	
	Green	Blinking	When the backlight blinks, the machine is receiving or printing data.
		On	The machine is on-line and can be used.
	Orange	On	A paper jam has occurred (see "Clearing original document jams" on page 96, "Clearing paper jams" on page 99).
	Red	Blinking	<ul style="list-style-type: none"> <li>A minor error has occurred and the machine is waiting for the error to be cleared. Check the display message. When the problem is cleared, the machine resumes. For some models that does not support the display screen on the control panel, this feature is not applicable.</li> <li>Small amount of toner is left in the cartridge. The estimated cartridge life of toner is close. Prepare a new cartridge for replacement. You may temporarily increase the printing quality by redistributing the toner (see "Redistributing toner" on page 76).</li> </ul>
		On	<ul style="list-style-type: none"> <li>A toner cartridge has almost reached its estimated cartridge life<sup>a</sup>. It is recommended to replace the toner cartridge (see "Replacing the toner cartridge" on page 79).</li> <li>There is no paper in the tray. Load paper in the tray.</li> <li>The machine has stopped due to a major error. Check the display message (see "Understanding display messages" on page 110).</li> <li>An imaging unit has almost reached its estimated cartridge life<sup>b</sup>. It is recommended to replace the toner cartridge (see "Replacing the imaging unit" on page 82).</li> </ul>
Wireless	Blue	Blinking	The machine is connecting to a wireless network.
		On	The machine is connected to a wireless network (see "Wireless network setup" on page 165).
		Off	The machine is disconnected from a wireless network.

# Understanding the status LED

Status		Description
 <b>Power/ Wake Up</b>	<b>Blue</b>	<b>On</b> The machine is in power save mode.
		<b>Off</b> The machine is in ready mode or machine's power is off.
<b>Eco</b>	<b>Green</b>	<b>On</b> Eco mode is on (see "Eco printing" on page 58).
		<b>Off</b> Eco mode is off.

- a. Estimated cartridge life means the expected or estimated toner cartridge life, which indicates the average capacity of print-outs and is designed pursuant to ISO/IEC 19752. The number of pages may be affected by operating environment, percentage of image area, printing interval, graphics, media and media size. Some amount of toner may remain in the cartridge even when red LED is on and the printer stops printing.
- b. When the imaging unit has reached its end of life, the machine will stop printing. In this case, you can choose to stop or continue printing from the SyncThru™ Web Service (**Settings > Machine Settings > System > Setup > Supplies Management > Imaging Unit Stop**) or Samsung Easy Printer Manager (**Device Settings > System > Supplies Management > Imaging Unit Stop**). Turning off this option and continuing to print may damage the device's system.

# Understanding display messages

Messages appear on the control panel display to indicate the machine's status or errors. Refer to the tables below to understand the messages' and their meaning, and correct the problem, if necessary.



- You can resolve the error with the guideline from the computer's Printing Status program window (see "Using Samsung Printer Status" on page 273).
- If a message is not in the table, reboot the power and try the printing job again. If the problem persists, call a service representative.
- When you call for service, provide the service representative with the contents of display message.
- Some messages may not appear on the display depending on the options or models.
- [error number] indicates the error number.
- [tray type] indicates the tray number.

Message	Meaning	Suggested solutions
• <b>Paper Jam in tray</b>	Paper has jammed in the paper feed area.	Clear the jam (see "In tray" on page 99).
• <b>Paper Jam in Manual Feeder</b>	Paper has jammed in the manual feeder.	Clear the jam (see "In the manual tray" on page 100).
• <b>Paper Jam inside machine</b>	Paper has jammed inside the machine.	Clear the jam (see "Inside the machine" on page 101).
• <b>Paper Jam in exit area</b>	Paper has jammed in the paper exit area.	Clear the jam (see "In the exit area" on page 104).
• <b>Paper Jam bottom of duplex</b> • <b>Paper Jam top of duplex</b>	Paper has jammed in the duplex area.	Clear the jam (see "In the duplex unit area" on page 105).

## Paper Jam-related messages

Message	Meaning	Suggested solutions
• <b>Document jam</b> <b>Remove jam</b>	The loaded original document has jammed in the document feeder.	Clear the jam (see "Clearing original document jams" on page 96).

# Understanding display messages

## Toner-related messages

Message	Meaning	Suggested solutions
<ul style="list-style-type: none"><li>• <b>Install Toner</b></li></ul>	A toner cartridge is not installed.	Install a toner cartridge.
<ul style="list-style-type: none"><li>• <b>Not Compatible Toner cartridge</b></li></ul>	The toner cartridge you have installed is not for your machine.	Install a Samsung-genuine toner cartridge, designed for your machine.
<ul style="list-style-type: none"><li>• <b>Prepare new cartridge</b></li></ul>	Small amount of toner is left in the indicated cartridge. The estimated cartridge life of toner is close.	Prepare a new cartridge for a replacement. You may temporarily increase the printing quality by redistributing the toner (see "Redistributing toner" on page 76).



# Understanding display messages

Message	Meaning	Suggested solutions
<ul style="list-style-type: none"> <li><b>Replace new cart</b></li> </ul>	The toner cartridge has almost reached its estimated cartridge life <sup>a</sup> .	<ul style="list-style-type: none"> <li>You can choose <b>Stop</b> or <b>Continue</b> as shown on the control panel. If you select <b>Stop</b>, the printer stops printing and you cannot print any more without changing the cartridge. If you select <b>Continue</b>, the printer keeps printing but the printing quality cannot be guaranteed.</li> <li>Replace the toner cartridge for the best print quality when this message appears. Using a cartridge beyond this stage can result in printing quality issues (see "Replacing the toner cartridge" on page 79).</li> </ul> <div style="border: 1px solid #ccc; padding: 5px; margin-top: 10px;">  Samsung does not recommend using a non-genuine Samsung toner cartridge such as refilled or remanufactured. Samsung cannot guarantee a non-genuine Samsung toner cartridge's quality. Service or repair required as a result of using non-genuine Samsung toner cartridges will not be covered under the machine warranty.         </div>
	The toner cartridge has reached its estimated cartridge life <sup>a</sup> .	If the machine stops printing, replace the toner cartridge (see "Replacing the toner cartridge" on page 79).

a. Estimated cartridge life means the expected or estimated toner cartridge life, which indicates the average capacity of print-outs and is designed pursuant to ISO/IEC 19752 (see "Available supplies" on page 72). The number of pages may be affected by operating environment, percentage of image area, printing interval, media, percentage of image area, and media size. Some amount of toner may remain in the cartridge even when replace new cartridge appears and the machine stops printing.

# Understanding display messages

## Imaging unit-related messages

Message	Meaning	Suggested solutions
<ul style="list-style-type: none"><li>• <b>Install Imaging Unit</b></li></ul>	Imaging unit is not installed.	Install an imaging unit.
<ul style="list-style-type: none"><li>• <b>Invalid Imaging Unit</b></li></ul>	The imaging unit you have installed is not for your machine.	Install a Samsung-genuine imaging unit, designed for your machine.
<ul style="list-style-type: none"><li>• <b>Prepare New Imaging Unit</b></li></ul>	The imaging unit has almost reached its estimated cartridge life. Replace the imaging unit as soon as possible.	Prepare a new imaging unit for a replacement. (see "Replacing the imaging unit" on page 82).
<ul style="list-style-type: none"><li>• <b>Replace Imaging Unit</b></li></ul>	The imaging unit has reached its estimated cartridge life.	Prepare a new imaging unit for a replacement. (see "Replacing the imaging unit" on page 82).

## Tray-related messages

Message	Meaning	Suggested solutions
<ul style="list-style-type: none"><li>• <b>Output bin full Remove paper</b></li></ul>	The output tray is full.	Remove papers from the output tray, the printer resumes printing.
<ul style="list-style-type: none"><li>• <b>Paper Empty in [tray type]</b></li></ul>	There is no paper in tray or manual feeder.	Load paper in tray (see "Loading paper in the tray" on page 42, "Loading paper in the tray" on page 42).
<ul style="list-style-type: none"><li>• <b>Tray Paper mismatch</b></li><li>• <b>Manual Paper mismatch</b></li></ul>	The paper size specified in the printer properties does not match the paper you are loading.	Load the required size paper.

## Network-related messages

Message	Meaning	Suggested solutions
<ul style="list-style-type: none"><li>• <b>Network Problem: IP Conflict</b></li></ul>	The network IP address you have set is being used by someone else.	Check the IP address and reset it if necessary (see Advanced Guide).

# Understanding display messages

## Misc. messages

Message	Meaning	Suggested solutions
• <b>Door of scanner is open</b>	The document feeder cover is not securely latched.	Close the cover until it locks into place.
• <b>Error [error number]</b> <b>Turn off then on</b>	The machine unit cannot be controlled.	Reboot the power and try the printing job again. If the problem persists, please call for service.
• <b>Memory Full</b> <b>Remove Job</b>	The memory is full.	Print or remove the received fax job in <b>Secure Receive</b> (see Advanced Guide).



# 5. Appendix

This chapter provides product specifications and information concerning applicable regulations.

- **Specifications** 116
- **Regulatory information** 126
- **Copyright** 139

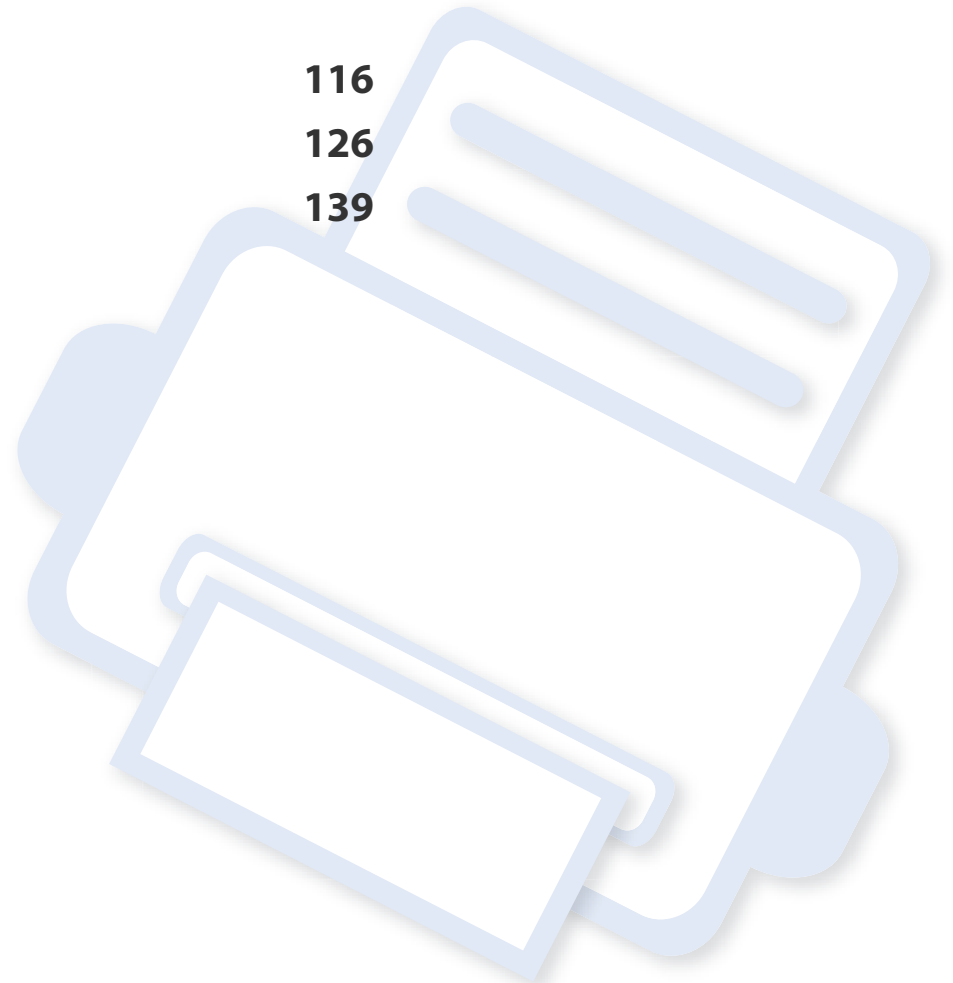

# Specifications

## General specifications



The specification values listed below are subject to change without notice. See [www.samsung.com](http://www.samsung.com) for possible changes in information.

Items		Description
<b>Dimension<sup>a</sup></b>	<b>Width x Length x Height</b>	401 x 362 x 367 mm (15.8 x 14.2 x 14.4 inches)
<b>Weight<sup>a</sup></b>	<b>Machine with consumables</b>	<ul style="list-style-type: none"><li>• <b>M2670 series:</b> 10.8kg (23.8 lbs)</li><li>• <b>M2870/M2880 series:</b> 11.2kg (24.7 lbs)</li><li>• <b>M2671/M2675/M2676 series:</b> 11.1kg (24.5 lbs)</li><li>• <b>M2875/M2876/M2885/M2886 series:</b> 11.3kg (24.9 lbs)</li></ul>
<b>Noise Level<sup>bc</sup></b>	<b>Ready mode</b>	26 dB (A)
	<b>Print mode</b>	Less than 50 dB (A)
	<b>Scan/Copy mode (scanner glass)</b>	52 dB (A)
	<b>Scan/Copy mode (document feeder)</b>	53 dB (A)
<b>Temperature</b>	<b>Operation</b>	10 to 30°C (50 to 86°F)
	<b>Storage (packed)</b>	-20 to 40°C (-4 to 104°F)
<b>Humidity</b>	<b>Operation</b>	20 to 80% RH
	<b>Storage (packed)</b>	10 to 90% RH

# Specifications

	Items	Description
<b>Power rating<sup>d</sup></b>	<b>110 volt models</b>	AC 110 - 127 V
	<b>220 volt models</b>	AC 220 - 240 V
<b>Power consumption<sup>e</sup></b>	<b>Average operating mode</b>	Less than 400 W
	<b>Ready mode</b>	Less than 50 W
	<b>Power save mode</b>	<ul style="list-style-type: none"> <li>• <b>M287xFW/M287xDW/M288xFW/M288xHW:</b> Less than 2.4 W (Wi-Fi Direct off: less than 1.6 W)</li> <li>• <b>M267xN/M267xF/M267xFH/M267xFN/ M267xHN/M287xND/M287xFD/M287xHN series:</b> Less than 1.1 W</li> </ul>
	<b>Power off mode<sup>f</sup></b>	Less than 0.2 W (0.1 W <sup>g</sup> )
	<b>Network Standby Mode (All Port Activation)</b>	<ul style="list-style-type: none"> <li>• <b>M267xF/M267xFD:</b> Less than 1W</li> <li>• <b>M267xFN:</b> Less than 1.4W</li> <li>• <b>M287xFD/M287xND:</b> Less than 1.35 W</li> <li>• <b>M287xDW:</b> Less than 1.59 W</li> <li>• <b>M287xFW/M288xFW:</b> Less than 1.95 W</li> </ul>
<b>Wireless<sup>h</sup></b>	<b>Module</b>	SPW-B4319S

a. Dimensions and weight are measured without a handset.

b. Sound Pressure Level, ISO 7779. Configuration tested: basic machine installation, A4 paper, simplex printing.

c. China only: If the equipment's noise is louder than 63 db (A) ,the equipment should be placed in region of relatively independent advice.

d. See the rating label on the machine for the correct voltage (V), frequency (hertz) and of current (A) for your machine.

e. The power consumption may be affected by the machine's status, setting conditions, operating environment, and measuring equipment and method the country uses.

f. Power consumption can be completely avoided only when the power cable is not connected.

g. For the machine that has a power switch.

h. M287xDW/M287xFW/M288xFW/M288xHW only (see "Features by model" on page 7).

# Specifications

## Print media specifications

Type	Size	Dimensions	Print media weight/Capacity <sup>a</sup>	
			Tray	Manual feeder <sup>b</sup>
Plain paper	<b>Letter</b>	216 x 279 mm (8.5 x 11 inches)	60 to 163 g/m <sup>2</sup> (16 to 43 lbs bond) • 250 sheets of 80 g/m <sup>2</sup> (21 lbs bond)	60 to 220 g/m <sup>2</sup> (16 to 59 lbs bond) • 1 sheet of 80 g/m <sup>2</sup> (21 lbs bond)
	<b>Legal</b>	216 x 356 mm (8.5 x 14 inches)		
	<b>US Folio</b>	216 x 330 mm (8.5 x 13 inches)		
	<b>A4</b>	210 x 297 mm (8.27 x 11.69 inches)		
	<b>Oficio</b>	216 x 343 mm (8.5 x 13.5 inches)		
	<b>JIS B5</b>	182 x 257 mm (7.17 x 10.12 inches)		
	<b>ISO B5</b>	176 x 250 mm (6.93 x 9.84 inches)		
	<b>Executive</b>	184 x 267 mm (7.25 x 10.5 inches)		
	<b>A5</b>	148 x 210 mm (5.83 x 8.27 inches)		
	<b>A6</b>	105 x 148 mm (4.13 x 5.83 inches)		

# Specifications

Type	Size	Dimensions	Print media weight/Capacity <sup>a</sup>	
			Tray	Manual feeder <sup>b</sup>
Envelope	Envelope Monarch	98 x 191 mm (3.87 x 7.5 inches)	Not available in tray	60 to 220 g/m <sup>2</sup> (16 to 59 lbs bond)
	Envelope No. 10	105 x 241 mm (4.12 x 9.5 inches)		
	Envelope DL	110 x 220 mm (4.33 x 8.66 inches)		
	Envelope C5	162 x 229 mm (6.38 x 9.02 inches)		
	Envelope C6	114 x 162 mm (4.49 x 6.38 inches)		
Thick paper	Refer to the Plain paper section	Refer to the Plain paper section	91 to 105 g/m <sup>2</sup> (24 to 28 lbs bond)	91 to 105 g/m <sup>2</sup> (24 to 28 lbs bond)
Thicker paper	Refer to the Plain paper section	Refer to the Plain paper section	Not available in tray	164 to 220 g/m <sup>2</sup> (44 to 59 lbs bond)
Thin paper	Refer to the Plain paper section	Refer to the Plain paper section	60 to 70 g/m <sup>2</sup> (16 to 19 lbs bond)	60 to 70 g/m <sup>2</sup> (16 to 19 lbs bond)
Transparency	Letter, A4	Refer to the Plain paper section	Not available in tray	138 to 146 g/m <sup>2</sup> (37 to 39 lbs bond)
Labels <sup>c</sup>	Letter, Legal, US Folio, A4, JIS B5, ISO B5, Executive, A5	Refer to the Plain paper section	Not available in tray	120 to 150 g/m <sup>2</sup> (32 to 40 lbs bond)



# Specifications

Type	Size	Dimensions	Print media weight/Capacity <sup>a</sup>	
			Tray	Manual feeder <sup>b</sup>
<b>Card stock</b>	<b>Letter, Legal, US Folio, A4, JIS B5, ISO B5, Executive, A5, Postcard 4x6</b>	Refer to the Plain paper section	121 to 163 g/m <sup>2</sup> (32 to 43 lbs bond)	121 to 163 g/m <sup>2</sup> (32 to 43 lbs bond)
<b>Bond paper</b>	<b>Refer to the Plain paper section</b>	Refer to the Plain paper section	106 to 120 g/m <sup>2</sup> (28 to 32 lbs bond)	106 to 120 g/m <sup>2</sup> (28 to 32 lbs bond)
<b>Minimum size (custom)</b>		<ul style="list-style-type: none"> <li><b>Manual feeder:</b> 76 x 127 mm (3 x 5 inches)</li> <li><b>Tray:</b> 105 x 148.5 mm (4.13 x 5.85 inches)</li> </ul>	60 to 163 g/m <sup>2</sup> (16 to 43 lbs bond) <sup>d, e</sup>	
<b>Maximum size (custom)</b>		216 x 356 mm (8.5 x 14 inches)		

a. Maximum capacity may differ depending on media weight, thickness, and environmental conditions.

b. 1 sheet for manual feeder.

c. The smoothness of the labels used in this machine is 100 to 250 (sheffield). This means the numeric level of smoothness.

d. The paper types available in the manual feeder: Plan, Thick, Thicker, Thin, Cotton, Colored, Pre-printed, Recycled, Envelope, Transparency, Labels, Cardstock, Bond, Archive

e. The paper types available in tray: Plan, Thick, Thin, Recycled, Cardstock, Bond, Archive

# Specifications

## System requirements

### Microsoft® Windows®

Operating system	Requirement (recommended)		
	CPU	RAM	free HDD space
<b>Windows® XP</b>	Intel® Pentium® III 933 MHz (Pentium IV 1 GHz)	128 MB (256 MB)	1.5 GB
<b>Windows Server® 2003</b>	Intel® Pentium® III 933 MHz (Pentium IV 1 GHz)	128 MB (512 MB)	1.25 GB to 2 GB
<b>Windows Server® 2008</b>	Intel® Pentium® IV 1 GHz (Pentium IV 2 GHz)	512 MB (2 GB)	10 GB
<b>Windows Vista®</b>	Intel® Pentium® IV 3 GHz	512 MB (1 GB)	15 GB
<b>Windows® 7</b>	Intel® Pentium® IV 1 GHz 32-bit or 64-bit processor or higher	1 GB (2 GB)	16 GB
	<ul style="list-style-type: none"> <li>• Support for DirectX® 9 graphics with 128 MB memory (to enable the Aero theme).</li> <li>• DVD-R/W Drive</li> </ul>		
<b>Windows Server® 2008 R2</b>	Intel® Pentium® IV 1.4 GHz (x64) processors (2 GHz or faster)	512 MB (2 GB)	10 GB
<b>Windows® 8</b> <b>Windows® 8.1</b> <b>Windows® 10</b> <b>Windows Server® 2016</b>	Intel® Pentium® IV 1 GHz 32-bit or 64-bit processor or higher	2 GB (2 GB)	20 GB
	<ul style="list-style-type: none"> <li>• Support for DirectX® 9 graphics with 128 MB memory (to enable the Aero theme).</li> <li>• DVD-R/W Drive</li> </ul>		
<b>Windows Server® 2012</b> <b>Windows Server® 2012 R2</b>	Intel® Pentium® IV 1.4 GHz (x64) processors (2 GHz or faster)	512 MB (2 GB)	32GB

# Specifications



- Internet Explorer 6.0 or higher is the minimum requirement for all Windows operating systems.
- Users who have administrator rights can install the software.
- **Windows Terminal Services** is compatible with your machine.

## Mac

Operating system	Requirements (Recommended)		
	CPU	RAM	Free HDD space
<b>Mac OS X 10.5</b>	<ul style="list-style-type: none"><li>• Intel® processors</li><li>• 867 MHz or faster Power PC G4/G5</li></ul>	512 MB (1 GB)	1 GB
<b>Mac OS X 10.6</b>	<ul style="list-style-type: none"><li>• Intel® processors</li></ul>	1 GB (2 GB)	1 GB
<b>Mac OS X 10.7-10.9</b>	<ul style="list-style-type: none"><li>• Intel® processors</li></ul>	2 GB	4 GB

# Specifications

## Linux

Items	Requirements
<b>Operating system</b>	Red Hat Enterprise Linux 5, 6 Fedora 11, 12, 13, 14, 15, 16, 17, 18, 19 OpenSUSE 11.0, 11.1, 11.2, 11.3, 11.4, 12.1, 12.2, 12.3 Ubuntu 10.04, 10.10, 11.04, 11.10, 12.04, 12.10, 13.04 SUSE Linux Enterprise Desktop 10, 11 Debian 5.0, 6.0, 7.0, 7.1 Mint 13, 14, 15
<b>CPU</b>	Pentium IV 2.4GHz (Intel Core™2)
<b>RAM</b>	512 MB (1 GB)
<b>Free HDD space</b>	1 GB (2 GB)

# Specifications

## Unix

---

Items	Requirements
<b>Operating system</b>	Sun Solaris 9, 10, 11 (x86, SPARC) HP-UX 11.0, 11i v1, 11i v2, 11i v3 (PA-RISC, Itanium) IBM AIX 5.1, 5.2, 5.3, 5.4, 6.1, 7.1 (PowerPC)
<b>Free HDD space</b>	Up to 100 MB

# Specifications

## Network environment



Network and wireless models only (see "Features by model" on page 7).

You need to set up the network protocols on the machine to use it as your network machine. The following table shows the network environments supported by the machine.

Items	Specifications
<b>Network interface</b>	<ul style="list-style-type: none"><li>• Ethernet 10/100 Base-TX Wired Lan</li><li>• 802.11b/g/n Wireless LAN (M287xDW/M287xFW/M288xFW/M288xHW only)</li></ul>
<b>Network operating system</b>	<ul style="list-style-type: none"><li>• Windows Server 2003 /Server 2008/XP/Vista/7/8/Server 2008 R2</li><li>• Various Linux OS</li><li>• Mac OS X 10.5 - 10.9</li><li>• Unix</li></ul>
<b>Network protocols</b>	<ul style="list-style-type: none"><li>• TCP/IPv4</li><li>• DHCP, BOOTP</li><li>• DNS, WINS, Bonjour, SLP, UPnP</li><li>• Standard TCP/IP Printing (RAW), LPR, IPP, WSD</li><li>• SNMPv 1/2/3, HTTP, IPSec</li><li>• TCP/IPv6 (DHCP, DNS, RAW, LPR, SNMPv 1/2/3, HTTP, IPSec)</li></ul>
<b>Wireless security</b>	<ul style="list-style-type: none"><li>• Authentication: Open System, Shared Key, WPA Personal, WPA2 Personal (PSK)</li><li>• Encryption: WEP64, WEP128, TKIP, AES</li></ul>

# Regulatory information

This machine is designed for a normal work environment and certified with several regulatory statements.

## Laser safety statement

The printer is certified in the U.S. to conform to the requirements of DHHS 21 CFR, chapter 1 Subchapter J for Class I(1) laser products, and elsewhere is certified as a Class I laser product conforming to the requirements of IEC 60825-1 : 2007.

Class I laser products are not considered to be hazardous. The laser system and printer are designed so there is never any human access to laser radiation above a Class I level during normal operation, user maintenance or prescribed service condition.

## Warning

Never operate or service the printer with the protective cover removed from laser/scanner assembly. The reflected beam, although invisible, can damage your eyes.

When using this product, these basic safety precautions should always be followed to reduce risk of fire, electric shock, and injury to persons:



CAUTION - CLASS 3B. INVISIBLE LASER RADIATION WHEN OPEN. AVOID EXPOSURE TO THE BEAM.

ATTENTION - CLASSE 3B. RADIATION LASER INVISIBLE EN CAS D'OUVERTURE. EVITER L'EXPOSITION AU FAISCEAU.

GEFAHREN - KLASSE 3B. UNSICHTBARE LASERSTRAHLUNG WENN GEOFFNET. STRAHLENAUSSETZUNG VERMEIDEN.

ATTENZIONE - CLASSE 3B. RADIAZIONI LASER INVISIBILI CON IL DISPOSITIVO APERTO. EVITARE L'ESPOSIZIONE AL RAGGIO.

PRECAUCIÓN - RADIACIÓN LÁSER INVISIBLE DE CLASE 3B PRESENTE AL ABRIR. EVITE LA EXPOSICIÓN AL HAZ.

PERIGO - CLASSE 3B. RADIAÇÃO LASER INVISÍVEL AO ABRIR. EVITE EXPOSIÇÃO DIRECTA AO FEIXE.

GEVAAR - KLASSE 3B. ONZICHTBARE LASERSTRALING INDIEN GEOPEND. VERMIJD BLOOTSTELLING AAN DE STRAAL.

ADVARSEL - KLASSE 3B. USYNLIG LASERSTRÅLING VED ÅBNING. UNDGÅ UDSÆTTELSE FOR STRÅLING.

ADVARSEL - KLASSE 3B. USYNLIG LASERSTRÅLING NÅR DEKSEL ÅPNES. UNNGÅ EKSPONERING FOR STRÅLEN.

VARNING - KLASSE 3B OSYNLIG LASERSTRÅLNING NÅR DENNA DEL ÅR ÖPPNAD. STRÅLEN ÅR FARLIG.

VAROITUS - LUOKAN 3B NÄKYMÄTTÖMÄLLE LASER-SÄTEILYÄ AVATTUNA. VÄLTÄ ALTISTUMISTA SÄTEELLE.

**注 意** - CLASS 3B. 严禁打开, 以免被不可见激光辐射 泄漏灼伤

**주 의** - 열리면 등급 3B 비가시 레이저 방사선이 방출됩니다. 광선에 노출을 피하십시오.

## Ozone safety



This product's ozone emission rate is under 0.1 ppm. Because ozone is heavier than air, keep the product in a place with good ventilation.

# Regulatory information

## Power saver



This printer contains advanced energy conservation technology that reduces power consumption when it is not in active use.

When the printer does not receive data for an extended period of time, power consumption is automatically lowered.

ENERGY STAR and the ENERGY STAR mark are registered U.S. marks.

For more information on the ENERGY STAR program see <http://www.energystar.gov>

For ENERGY STAR certified models, the ENERGY STAR label will be on your machine. Check if your machine is ENERGY STAR certified.

## Recycling



Recycle or dispose of the packaging material for this product in an environmentally responsible manner.

## China only

### 回收和再循环

为了保护环境，我公司已经为废弃的产品建立了回收和再循环系统。我们会为您无偿提供回收同类废旧产品的服务。当您废弃您正在使用的产品时，请您及时与授权耗材更换中心取得联系，我们会及时为您提供服务。

Website: <http://www.samsung.com/cn/support/location/supportServiceLocation.do?page=SERVICE.LOCATION>

### 中国能效标识

型号	能效等级	典型能耗 ( kW·h )
Xpress M2676N	2	1.15
Xpress M2676FH	2	1.18
Xpress M2671N	2	1.15
Xpress M2671FH	2	1.13
Xpress M2871HN	2	1.33
Xpress M2876HN	2	1.33
Xpress M2886HW	2	1.30

依据国家标准 GB 21521-2014



# Regulatory information

## Correct disposal of this product (Waste electrical & electronic equipment)

### (Applicable in countries with separate collection systems)



This marking on the product, accessories or literature indicates that the product and its electronic accessories (e.g. charger, headset, USB cable) should not be disposed of with other household waste at the end of their working life. To prevent possible harm to the environment or human health from uncontrolled waste disposal, please separate these items from other s of waste and recycle them responsibly to promote the sustainable reuse of material resources.

Household users should contact either the retailer where they purchased this product, or their local government office, for details of where and how they can take these items for environmentally safe recycling.

Business users should contact their supplier and check the terms and conditions of the purchase contract. This product and its electronic accessories should not be mixed with other commercial wastes for disposal.

## (The United States of America only)

Dispose unwanted electronics through an approved recycler. To find the nearest recycling location, go to our website: [www.samsung.com/recyclingdirect](http://www.samsung.com/recyclingdirect) Or call, (877) 278 - 0799

## EU REACH SVHC Declaration

For information on Samsung's environmental commitments and product specific regulatory obligations e.g. REACH visit: [www.samsung.com/uk/aboutsamsung/samsungelectronics/corporatecitizenship/data\\_corner.html](http://www.samsung.com/uk/aboutsamsung/samsungelectronics/corporatecitizenship/data_corner.html)

## State of California Proposition 65 Warning (USA only)

The California Safe Drinking Water and Toxic Enforcement Act requires the Governor of California to publish a list of chemicals known to the state of California to cause cancer or reproductive toxicity and requires businesses to warn of exposure to such chemicals.

**WARNING:** This product contains chemicals known to the State of California to cause cancer and birth defects or other reproductive harm. This appliance and its accessories can cause low-level exposure to chemicals during operation, which can be reduced by operating the appliance in a well ventilated area, and low-level exposure to chemicals through other use or handling.

# Regulatory information

## Taiwan only

### 警告

本電池如果更換不正確會有爆炸的危險  
請依製造商說明書處理用過之電池

## Radio frequency emissions

### FCC information to the user

---

This device complies with Part 15 of the FCC Rules. Operation is subject to the following two conditions:

- This device may not cause harmful interference, and
- This device must accept any interference received, including interference that may cause undesired operation.

This equipment has been tested and found to comply with the limits for a Class B digital device, pursuant to Part 15 of the FCC Rules. These limits are designed to provide reasonable protection against harmful interference in a residential installation. This equipment generates, uses and can radiate radio frequency energy and, if not installed and used in accordance with the instructions, may cause harmful interference to radio communications. However, there is no guarantee that interference will not occur in a particular installation. If this equipment does cause harmful interference to radio or television reception, which can be determined by turning the equipment off and on, the user is encouraged to try to correct the interference by one or more of the following measures:

- Reorient or relocate the receiving antenna.
- Increase the separation between the equipment and receiver.
- Connect the equipment into an outlet on a circuit different from that to which the receiver is connected.
- Consult the dealer or experienced radio TV technician for help.



Change or modifications not expressly approved by the manufacturer responsible for compliance could void the user's authority to operate the equipment.

# Regulatory information

## Canadian radio interference regulations

---

This digital apparatus does not exceed the Class B limits for radio noise emissions from digital apparatus as set out in the interference-causing equipment standard entitled “Digital Apparatus”, ICES-003 of the Industry and Science Canada.

Cet appareil numérique respecte les limites de bruits radioélectriques applicables aux appareils numériques de Classe B prescrites dans la norme sur le matériel brouilleur: “Appareils Numériques”, ICES-003 édictée par l’Industrie et Sciences Canada.

## United States of America

### Federal Communications Commission (FCC)

---

#### Intentional emitter per FCC Part 15

Low power, Radio LAN devices (radio frequency (RF) wireless communication devices), operating in the 2.4 GHz/5 GHz Band, may be present (embedded) in your printer system. This section is only applicable if these devices are present. Refer to the system label to verify the presence of wireless devices.

Wireless devices that may be in your system are only qualified for use in the United States of America if an FCC ID number is on the system label.

The FCC has set a general guideline of 20 cm (8 inches) separation between the device and the body, for use of a wireless device near the body (this does not include extremities). This device should be used more than 20 cm (8 inches) from the body when wireless devices are on. The power output of the wireless device (or devices), which may be embedded in your printer, is well below the RF exposure limits as set by the FCC.

This transmitter must not be collocated or operation in conjunction with any other antenna or transmitter.

Operation of this device is subject to the following two conditions: (1) This device may not cause harmful interference, and (2) this device must accept any interference received, including interference that may cause undesired operation of the device.



Wireless devices are not user serviceable. Do not modify them in any way. Modification to a wireless device will void the authorization to use it. Contact manufacturer for service.

# Regulatory information

## FCC Statement for Wireless LAN use:



While installing and operating this transmitter and antenna combination the radio frequency exposure limit of 1m W/cm<sup>2</sup> may be exceeded at distances close to the antenna installed. Therefore, the user must maintain a minimum distance of 20cm from the antenna at all times. This device cannot be colocated with another transmitter and transmitting antenna.

## Russia / Kazakhstan / Belarus only



Изготовитель: «Самсунг Электроникс Ко., Лтд.»  
(Мэтан-донг) 129, Самсунг-ро, Енгтонг-гу, г. Сувон, Кёнги-до, Республика Корея  
Импортер: ООО «Самсунг Электроникс Рус Компани»  
Адрес: 125009, г. Москва, ул. Воздвиженка 10

Самсунг Электроникс Ко. Лтд  
(Мэтан-донг) 129, Самсунг-ро, Енгтонг-гу, Сувон қ., Кёнги-до, Корея Республикасы  
«САМСУНГ ЭЛЕКТРОНИКС КЗ ЭНД ЦЕНТРАЛ ЭЙЖА» ЖШС  
Заңды мекен-жайы: Қазақстан Республикасы, Алматы қ., Әл-Фараби даңғылы, 36, 3,4-қабаттар

## Germany only

Das Gerät ist nicht für die Benutzung am Bildschirmarbeitsplatz gemäß Bildschirmarbeitsverordnung vorgesehen.

Das Gerät kann der Bildschirmarbeitsverordnung unterliegen und in diesem Zusammenhang Abweichungen von den Anforderungen (Zeichengröße auf Bildschirmgerät und Tastatur) aufweisen. Es ist daher für Tätigkeiten nicht geeignet, bei denen Beschäftigte das Gerät für einen nicht unwesentlichen Teil ihrer normalen Arbeit mit Bildschirmarbeit benutzen.

Bei Aufstellung des Gerätes darauf achten, dass Blendungen durch in der Anzeige spiegelnde Lichtquellen vermieden werden.

## Turkey only

- Bu ürünün ortalama yaşam süresi 7 yıl, garanti süresi 2 yıldır.

## Thailand only

This telecommunication equipment conforms to NTC technical requirement.

# Regulatory information

## Canada only

This product meets the applicable Industry Canada technical specifications. / Le présent matériel est conforme aux spécifications techniques applicables d'Industrie Canada.

The Ringer Equivalence Number (REN) is an indication of the maximum number of devices allowed to be connected to a telephone interface. The termination of an interface may consist of any combination of devices subject only to the requirement that the sum of the RENs of all the devices not exceed five. / L'indice d'équivalence de la sonnerie (IES) sert à indiquer le nombre maximal de terminaux qui peuvent être raccordés à une interface téléphonique. La terminaison d'une interface peut consister en une combinaison quelconque de dispositifs, à la seule condition que la somme d'indices d'équivalence de la sonnerie de tous les dispositifs n'excede pas cinq.

## Fax Branding

The Telephone Consumer Protection Act of 1991 makes it unlawful for any person to use a computer or other electronic device to send any message via a telephone facsimile machine unless such message clearly contains in a margin at the top or bottom of each transmitted page or on the first page of the transmission the following information:

- 1** the date and time of transmission
- 2** identification of either business, business entity or individual sending the message; and
- 3** telephone number of either the sending machine, business, business entity or individual.

The Telephone Company may make changes in its communications facilities, equipment operations or procedures where such action is reasonably required in the operation of its business and is not inconsistent with the rules and regulations in FCC Part 68. If such changes can be reasonably expected to render any customer terminal equipment incompatible with telephone company communications facilities, or require modification or alteration of such terminal equipment, or otherwise materially affect its use or performance, the customer shall be given adequate notice in writing, to allow the customer an opportunity to maintain uninterrupted service

# Regulatory information

## Ringer Equivalence Number

The Ringer Equivalence Number and FCC Registration Number for this machine may be found on the label located on the bottom or rear of the machine. In some instances you may need to provide these numbers to the telephone company.

The Ringer Equivalence Number (REN) is a measure of the electrical load placed on the telephone line, and is useful for determining whether you have “overloaded” the line. Installing several s of equipment on the same telephone line may result in problems making and receiving telephone calls, especially ringing when your line is called. The sum of all Ringer Equivalence Numbers of the equipment on your telephone line should be less than five in order to assure proper service from the telephone company. In some cases, a sum of five may not be usable on your line. If any of your telephone equipment is not operating properly, you should immediately remove it from your telephone line, as it may cause harm to the telephone network.

The equipment complies with Part 68 of the FCC rules and the requirements adopted by the ACTA. On the rear of this equipment is a label that contains, among other information, a product identifier in the format US:AAAEQ##TXXXX. If requested, this number must be provided to the telephone company.



FCC Regulations state that changes or modifications to this equipment not expressly approved by the manufacturer could void the user’s authority to operate this equipment. In the event that terminal equipment causes harm to the telephone network, the telephone company should notify the customer that service may be stopped. However, where prior notice is impractical, the company may temporarily cease service, providing that they:

- a promptly notify the customer.
- b give the customer an opportunity to correct the equipment problem.
- c inform the customer of the right to bring a complaint to the Federal Communication Commission pursuant to procedures set out in FCC Rules and Regulations Subpart E of Part 68.

## You should also know that:

- Your machine is not designed to be connected to a digital PBX system.
- If you intend to use a computer modem or fax modem on the same phone line as your machine, you may experience transmission and reception problems with all the equipment. It is recommended that no other equipment, except for a regular telephone, share the line with your machine.
- If your area experiences a high incidence of lightning or power surges, we recommend that you install surge protectors for both the power and the telephone lines. Surge protectors can be purchased from your dealer or telephone and electronic specialty stores.

# Regulatory information

- When programming emergency numbers and/or making test calls to emergency numbers, use a non-emergency number to advise the emergency service dispatcher of your intentions. The dispatcher will give you further instructions on how to actually test the emergency number.
- This machine may not be used on coin service or party lines.
- This machine provides magnetic coupling to hearing aids.

You may safely connect this equipment to the telephone network by means of a standard modular jack, USOC RJ-11C.

## Replacing the Fitted Plug (for UK Only)

### Important

The mains lead for this machine is fitted with a standard (BS 1363) 13 amp plug and has a 13 amp fuse. When you change or examine the fuse, you must re-fit the correct 13 amp fuse. You then need to replace the fuse cover. If you have lost the fuse cover, do not use the plug until you have another fuse cover.

Contact the people from you purchased the machine.

The 13 amp plug is the most widely used in the UK and should be suitable. However, some buildings (mainly old ones) do not have normal 13 amp plug sockets. You need to buy a suitable plug adaptor. Do not remove the moulded plug.



If you cut off the moulded plug, get rid of it straight away.

You cannot rewire the plug and you may receive an electric shock if you plug it into a socket.

### Important warning:



You must earth this machine.

The wires in the mains lead have the following color code:

- **Green and Yellow:** Earth
- **Blue:** Neutral
- **Brown:** Live

If the wires in the mains lead do not match the colors marked in your plug, do the following:

You must connect the green and yellow wire to the pin marked by the letter “E” or by the safety ‘Earth symbol’ or colored green and yellow or green.

You must connect the blue wire to the pin which is marked with the letter “N” or colored black.

You must connect the brown wire to the pin which is marked with the letter “L” or colored red.

You must have a 13 amp fuse in the plug, adaptor, or at the distribution board.

# Regulatory information

## Declaration of conformity (European countries)

### Approvals and Certifications

Hereby, Samsung Electronics, declares that this [Xpress M267xN, Xpress M287xND] is in compliance with the essential requirements and other relevant provisions of Low Voltage Directive (2006/95/EC), EMC Directive (2004/108/EC).



Hereby, Samsung Electronics, declares that this [Xpress M267xF, Xpress M267xFH, Xpress M267xFN, Xpress M267xHN, Xpress M287xFD, Xpress M287xHN, Xpress M287xDW, Xpress M287xFW, Xpress M288xFW, Xpress M288xHW] is in compliance with the essential requirements and other relevant provisions of R&TTE Directive 1999/5/EC.

The declaration of conformity may be consulted at [www.samsung.com](http://www.samsung.com), go to Support > Download center and enter your printer (MFP) name to browse the EuDoC.

**January 1, 1995:** Council Directive 2006/95/EC Approximation of the laws of the member states related to low voltage equipment.

**January 1, 1996:** Council Directive 2004/108/EC, approximation of the laws of the Member States related to electromagnetic compatibility.

**March 9, 1999:** Council Directive 1999/5/EC on radio equipment and telecommunications terminal equipment and the mutual recognition of their conformity. A full declaration, defining the relevant Directives and referenced standards can be obtained from your Samsung Electronics Co., Ltd. representative.

### EC Certification

Certification to 1999/5/EC Radio Equipment & Telecommunications Terminal Equipment Directive (FAX)

This Samsung product has been self-certified by Samsung for pan-European single terminal connection to the analogue public switched telephone network (PSTN) in accordance with Directive 1999/5/EC. The product has been designed to work with the national PSTNs and compatible PBXs of the European countries:

In the event of problems, you should contact the Euro QA Lab of Samsung Electronics Co., Ltd. in the first instance.

The product has been tested against TBR21. To assist in the use and application of terminal equipment which complies with this standard, the European Telecommunication Standards Institute (ETSI) has issued an advisory document (EG 201 121) which contains notes and additional requirements to ensure network compatibility of TBR21 terminals. The product has been designed against, and is fully compliant with, all of the relevant advisory notes contained in this document.



# Regulatory information

## European radio approval information (for products fitted with EU-approved radio devices)

Low power, Radio LAN type devices (radio frequency (RF) wireless communication devices), operating in the 2.4 GHz/5 GHz band, may be present (embedded) in your printer system which is intended for home or office use. This section is only applicable if these devices are present. Refer to the system label to verify the presence of wireless devices.



Wireless devices that may be in your system are only qualified for use in the European Union or associated areas if a CE mark is on the system label.

The power output of the wireless device or devices that may be embedded in your printer is well below the RF exposure limits as set by the European Commission through the R&TTE directive.

### European states qualified under wireless approvals:

EU countries

### European states with restrictions on use:

EU

EEA/EFTA countries

No limitations at this time

## Israel only

מס' אישור אלחוטי של משרד התקשורת הוא 51-29003  
אסור להחליף את האנטנה המקורית של המכשיר,  
ולא לעשות בו כל שינוי טכני אחר.

## Regulatory compliance statements

### Wireless guidance

Low power, Radio LAN devices (radio frequency (RF) wireless communication devices), operating in the 2.4 GHz/5 GHz Band, may be present (embedded) in your printer system. The following section is a general overview of considerations while operating a wireless device.

Additional limitations, cautions, and concerns for specific countries are listed in the specific country sections (or country group sections). The wireless devices in your system are only qualified for use in the countries identified by the Radio Approval Marks on the system rating label. If the country you will be using the wireless device in, is not listed, contact your local Radio Approval agency for requirements. Wireless devices are closely regulated and use may not be allowed.

# Regulatory information

The power output of the wireless device or devices that may be embedded in your printer is well below the RF exposure limits as known at this time. Because the wireless devices (which may be embedded into your printer) emit less energy than is allowed in radio frequency safety standards and recommendations, manufacturer believes these devices are safe for use. Regardless of the power levels, care should be taken to minimize human contact during normal operation.

As a general guideline, a separation of 20 cm (8 inches) between the wireless device and the body, for use of a wireless device near the body (this does not include extremities) is typical. This device should be used more than 20 cm (8 inches) from the body when wireless devices are on and transmitting.

This transmitter must not be collocated or operation in conjunction with any other antenna or transmitter.

Some circumstances require restrictions on wireless devices. Examples of common restrictions are listed below:



Radio frequency wireless communication can interfere with equipment on commercial aircraft. Current aviation regulations require wireless devices to be turned off while traveling in an airplane. IEEE 802.11 (also known as wireless Ethernet) and Bluetooth communication devices are examples of devices that provide wireless communication.



In environments where the risk of interference to other devices or services is harmful or perceived as harmful, the option to use a wireless device may be restricted or eliminated. Airports, Hospitals, and Oxygen or flammable gas laden atmospheres are limited examples where use of wireless devices may be restricted or eliminated. When in environments where you are uncertain of the sanction to use wireless devices, ask the applicable authority for authorization prior to use or turning on the wireless device.



Every country has different restrictions on the use of wireless devices. Since your system is equipped with a wireless device, when traveling between countries with your system, check with the local Radio Approval authorities prior to any move or trip for any restrictions on the use of a wireless device in the destination country.



If your system came equipped with an internal embedded wireless device, do not operate the wireless device unless all covers and shields are in place and the system is fully assembled.



Wireless devices are not user serviceable. Do not modify them in any way. Modification to a wireless device will void the authorization to use it. Contact manufacturer for service.



Only use drivers approved for the country in which the device will be used. See the manufacturer System Restoration Kit, or contact manufacturer Technical Support for additional information.

# Regulatory information

China only

## 产品中有害物质的名称及含量

部件名称	有害物质					
	铅 (Pb)	汞 (Hg)	镉 (Cd)	六价铬 (Cr <sup>6+</sup> )	多溴联苯 (PBB)	多溴二苯醚 (PBDE)
塑料	○	○	○	○	○	○
金属 (机箱)	×	○	○	○	○	○
印刷电路部件 (PCA)	×	○	○	○	○	○
电缆 / 连接器	×	○	○	○	○	○
电源设备	×	○	○	○	○	○
电源线	×	○	○	○	○	○
机械部件	×	○	○	○	○	○
卡盒部件	×	○	○	○	○	○
定影部件	×	○	○	○	○	○
扫描仪部件 - CCD (如果有)	×	×	○	○	○	○
扫描仪部件 - 其它 (如果有)	×	○	○	○	○	○
印刷电路板部件 (PBA)	×	○	○	○	○	○
墨粉	○	○	○	○	○	○
滚筒	○	○	○	○	○	○

本表格依据 SJ/T 11364 的规定编制。

○：表示该有害物质在该部件所有均质材料中的含量均在 GB/T 26572 规定的限量要求以下。

×：表示该有害物质至少在该部件的某一均质材料中的含量超出 GB/T 26572 规定的限量要求。

# Copyright

© 2013 Samsung Electronics Co., Ltd. All rights reserved.

This user's guide is provided for information purposes only. All information included herein is subject to change without notice.

Samsung Electronics is not responsible for any direct or indirect damages, arising from or related to use of this user's guide.

- Samsung and the Samsung logo are trademarks of Samsung Electronics Co., Ltd.
- Microsoft, Windows, Windows Vista, Windows 7, Windows 8, Windows Server 2008 R2, Windows 10 and Windows Server 2016 are either registered trademarks or trademarks of Microsoft Corporation.
- iPad, iPhone, iPod touch, Mac and Mac OS are trademarks of Apple Inc., registered in the U.S and other countries. AirPrint and the AirPrint logo are trademarks of Apple Inc.
- Google, Picasa, Google Cloud Print, Google Docs, Android and Gmail are either registered trademarks or trademarks of Google Inc.
- Google Cloud Print is a trademark of Google Inc.
- LaserWriter is a trademark of Apple Computer, Inc.
- All other brand or product names are trademarks of their respective companies or organizations.

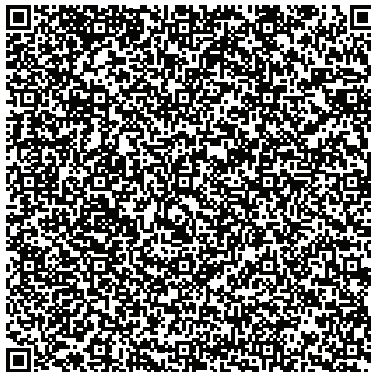

QR code

The software included in this product contains open source software. You may obtain the complete corresponding source code for a period of three years after the last shipment of this product by sending an email to <mailto:oss.request@samsung.com>. It is also possible to obtain the complete corresponding source code in a physical medium such as a CD-ROM; a minimal charge will be required.

**The following URL [http://opensource.samsung.com/opensource/Samsung\\_M267x\\_M287x\\_M288x\\_Series/seq/34](http://opensource.samsung.com/opensource/Samsung_M267x_M287x_M288x_Series/seq/34) leads to the download page of the source code made available and open source license information as related to this product.** This offer is valid to anyone in receipt of this information.



# User's Guide

---

## Samsung Printer *Xpress*

M267x series

M287x series

M288x series

### **ADVANCED**

This guide provides information about installation, advanced configuration, operation and troubleshooting on various OS environments.

Some features may not be available depending on models or countries.

### **BASIC**

This guide provides information concerning installation, basic operation and troubleshooting on Windows.

# ADVANCED



## 1. Software Installation

<b>Installation for Mac</b>	144
<b>Reinstallation for Mac</b>	145
<b>Installation for Linux</b>	146
<b>Reinstallation for Linux</b>	147



## 2. Using a Network-Connected Machine

<b>Useful network programs</b>	149
<b>Wired network setup</b>	150
<b>Installing driver over the network</b>	153
<b>IPv6 configuration</b>	162
<b>Wireless network setup</b>	165
<b>Samsung Mobile Print</b>	196
<b>Using the NFC feature</b>	197
<b>AirPrint</b>	203
<b>Google Cloud Print™</b>	205



## 3. Useful Setting Menus

<b>Before you begin reading a chapter</b>	209
<b>Print menu</b>	210
<b>Copy menu</b>	211
<b>Fax menu</b>	214
<b>System setup</b>	217



## 4. Special Features

<b>Altitude adjustment</b>	225
<b>Entering various characters</b>	226
<b>Setting up the fax address book</b>	228
<b>Printing features</b>	231
<b>Scan features</b>	245
<b>Fax features</b>	252



## 5. Useful Management Tools

<b>Accessing management tools</b>	262
<b>Easy Capture Manager</b>	263
<b>Samsung AnyWeb Print</b>	264
<b>Easy Eco Driver</b>	265
<b>Using SyncThru™ Web Service</b>	266
<b>Using Samsung Easy Document Creator</b>	269
<b>Using Samsung Easy Printer Manager</b>	270
<b>Using Samsung Printer Status</b>	273
<b>Using Samsung Printer Experience</b>	275



## 6. Troubleshooting

<b>Paper feeding problems</b>	282
<b>Power and cable connecting problems</b>	283
<b>Printing problems</b>	284
<b>Printing quality problems</b>	288
<b>Copying problems</b>	296
<b>Scanning problems</b>	297
<b>Faxing problems</b>	299
<b>Operating system problems</b>	301





# 1. Software Installation

This chapter provides instructions for installing essential and helpful software for use in an environment where the machine is connected via a cable. A locally connected machine is a machine directly attached to your computer using the cable. If your machine is attached to a network, skip the following steps below and go on to installing a network connected machine's driver (see "Installing driver over the network" on page 153).

- **Installation for Mac** **144**
- **Reinstallation for Mac** **145**
- **Installation for Linux** **146**
- **Reinstallation for Linux** **147**



- If you are a Windows OS user, refer to the Basic Guide for installing the machine's driver (see "Installing the driver locally" on page 29).
- Only use a USB cable no longer than 3 meter (118 inches).

# Installation for Mac

**1** Make sure that the machine is connected to your computer and powered on.

**2** Insert the supplied software CD into your CD-ROM drive.

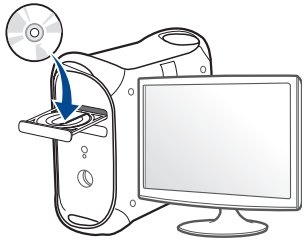

**3** Double-click the CD-ROM icon that appears on your Mac desktop.

- For Mac OS X 10.8, double-click the CD-ROM that appears on **Finder**.

**4** Double-click the **MAC\_Installer** folder > **Installer OS X** icon.

**5** Click **Continue**.

**6** Read the license agreement and click **Continue**.

**7** Click **Agree** to agree to the license agreement.

**8** Click **Install**. All components necessary for machine operations will be installed.

If you click **Customize**, you can choose individual components to install.

**9** Enter the password and click **OK**.

**10** Select **USB Connected Printer** on the **Printer Connection Type** and click **Continue**.

**11** Click **Add Printer** button to select your printer and add it to your printer list.

If your machine supports fax, click **Add Fax** button to select your fax and add it to your fax list

**12** After the installation is finished, click **Close**.

# Reinstallation for Mac

If the printer driver does not work properly, uninstall the driver and reinstall it.

- 1 Open the **Applications** folder > **Samsung** > **Printer Software Uninstaller**.
- 2 To uninstall printer software, click **Continue**.
- 3 Check the program you want to delete and click **Uninstall**.
- 4 Enter the password and click **OK**.
- 5 After the uninstallation is finished, click **Close**.



If a machine has already been added, delete it from the **Print Setup Utility** or **Print & Fax**.

# Installation for Linux

You need to download the Linux software packages from the Samsung website to install the printer software (<http://www.samsung.com> > find your product > Support or Downloads).

## Installing the Unified Linux Driver



You must log in as a super user (root) to install the machine software. If you are not a super user, ask your system administrator.

- 1 Make sure that the machine is connected to your computer and powered on.
- 2 Copy the **Unified Linux Driver** package to your system.
- 3 Open Terminal program and go to the folder that you copied the package to.
- 4 Extract the package.
- 5 Move to **uld** folder.
- 6 Execute **"./install.sh"** command (If you're not logged in as a root, execute the command with **"sudo"** as **"sudo ./install.sh"**)
- 7 Proceed with the installation.

- 8 When the installation is finished, launch printing utility(Go to **System** > **Administration** > **Printing** or execute **"system-config-printer"** command in Terminal program).
- 9 Click **Add** button.
- 10 Select your printer.
- 11 Click the **Forward** button and add it to your system.

# Reinstallation for Linux

If the printer driver does not work properly, uninstall the driver and reinstall it.

- 1 Open **Terminal** program.
- 2 Move to **uld** folder extracted from **Unified Linux Driver** package.
- 3 Execute "**./uninstall.sh**" command (If you're not logged in as root, execute the command with "**sudo**" as "**sudo ./uninstall.sh**")
- 4 Proceed with the uninstallation.



## 2. Using a Network-Connected Machine

This chapter gives you step-by-step instructions for setting up a network connected machine and software.

- **Useful network programs** 149
- **Wired network setup** 150
- **Installing driver over the network** 153
- **IPv6 configuration** 162
- **Wireless network setup** 165
- **Samsung Mobile Print** 196
- **Using the NFC feature** 197
- **AirPrint** 203
- **Google Cloud Print™** 205



Supported optional devices and features may differ according to your model (see "Features by model" on page 7).

# Useful network programs

There are several programs available to setup the network settings easily in a network environment. For the network administrator especially, managing several machines on the network is possible.



- Before using the programs below, set the IP address first.
- Some features and optional goods may not be available depending on model or country (see "Features by model" on page 7).

## SyncThru™ Web Service

The web server embedded on your network machine allows you to do the following tasks (see "Using SyncThru™ Web Service" on page 266).

- Check the supplies information and status.
- Customize machine settings.
- Set the email notification option. When you set this option, the machine status (toner cartridge shortage or machine error) will be sent to a certain person's email automatically.
- Configure the network parameters necessary for the machine to connect to various network environments.

## SyncThru™ Web Admin Service

Web-based machine management solution for network administrators. SyncThru™ Web Admin Service provides you with an efficient way of managing network devices and lets you remotely monitor and troubleshoot network machines from any site with corporate internet access.

- Download this program from <http://solution.samsungprinter.com>.

## SetIP wired network setup

This utility program allows you to select a network interface and manually configure the IP addresses for use with the TCP/IP protocol.

- See "IPv4 configuration using SetIP (Windows)" on page 150.
- See "IPv4 configuration using SetIP (Mac)" on page 151.
- See "IPv4 configuration using SetIP (Linux)" on page 152.



- This feature is not available for the machine that does not support the network interface (see "Rear view" on page 23).
- TCP/IPv6 is not supported by this program.

# Wired network setup

## Printing a network configuration report

You can print **Network Configuration Report** from the machine's control panel that will show the current machine's network settings. This will help you to set up a network.

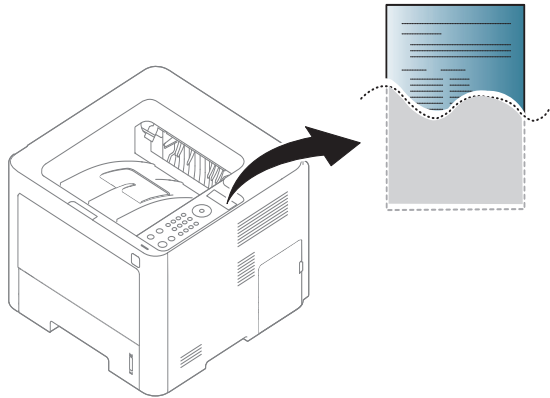

- Accessing menus may differ from model to model (see "Accessing the menu" on page 33).
- It may be necessary to press **OK** to navigate to lower-level menus for some models.

- **The machine has the display screen:** Press the  (**Menu**) button on the control panel and select **Network > Network Conf.**

Using this **Network Configuration Report**, you can find your machine's MAC address and IP address.

For example:

- MAC Address: 00:15:99:41:A2:78
- IP Address: 169.254.192.192

## Setting IP address

- This feature is not available for the machine that does not support the network interface (see "Rear view" on page 23).
- TCP/IPv6 is not supported by this program.

First, you have to set up an IP address for network printing and managements. In most cases a new IP address will be automatically assigned by a DHCP (Dynamic Host Configuration Protocol) server located on the network.

## IPv4 configuration using SetIP (Windows)

Before using the SetIP program, disable the computer firewall from **Control Panel > Security Center > Windows Firewall**.

- The following instructions may differ for your model.



# Wired network setup

- 1 Download the software from the Samsung website then unpack and install it: (<http://www.samsung.com> > find your product > Support or Downloads).
- 2 Follow the instructions in the installation window.
- 3 Connect your machine to the network with a network cable.
- 4 Turn on the machine.
- 5 From the Windows **Start** menu, select **All Programs > Samsung Printers > SetIP > SetIP**.
- 6 Click the  icon (third from left) in the SetIP window to open the TCP/IP configuration window.
- 7 Enter the machine's new information into the configuration window. In a corporate intranet, you may need to have this information assigned by a network manager before proceeding.



Find the machine's MAC address from the **Network Configuration Report** (see "Printing a network configuration report" on page 150) and enter it without the colons. For example, 00:15:99:29:51:A8 becomes 0015992951A8.

- 8 Click **Apply**, and then click **OK**. The machine will automatically print the **Network Configuration Report**. Confirm that all the settings are correct.

## IPv4 configuration using SetIP (Mac)

Before using the SetIP program, disable the computer firewall from **System Preferences > Security > Firewall**.



The following instructions may vary from your model.

- 1 Connect your machine to the network with a network cable.
- 2 Insert the supplied software CD into your CD-ROM drive.

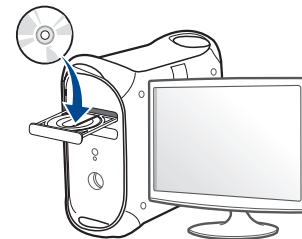

- 3 Double-click the CD-ROM icon that appears on your Mac desktop.
  - For Mac OS X 10.8, Double-click the CD-ROM that appears on Finder.
- 4 Double-click the **MAC\_Installer** folder > **Installer OS X** icon.
- 5 Click **Continue**.
- 6 Read the license agreement and click **Continue**.
- 7 Click **Agree** to agree to the license agreement.

# Wired network setup

- 8 Click **Install**. All components necessary for machine operations will be installed.  
If you click **Customize**, you can choose individual components to install.
- 9 Enter the password and click **OK**.
- 10 When the message that warns that all applications will close on your computer appears, click **Continue**.
- 11 Select **Network Connected Printer(Wired or Wireless)** on the **Printer Connection Type** and click **Set IP Address** button.
- 12 Click the  icon (third from left) in the SetIP window to open the TCP/IP configuration window.
- 13 Enter the machine's new information into the configuration window. In a corporate intranet, you may need to have this information assigned by a network manager before proceeding.

 Find the machine's MAC address from the **Network Configuration Report** (see "Printing a network configuration report" on page 150) and enter it without the colons. For example, 00:15:99:29:51:A8 becomes 0015992951A8.

- 14 Click **Apply**, and then click **OK**. The machine will automatically print the **Network Configuration Report**. Confirm that all the settings are correct.

## IPv4 configuration using SetIP (Linux)

Before using the SetIP program, disable the computer firewall from **System Preferences** or **Administrator**.



The following instructions may vary from your model or operating systems.

- 1 Download the SetIP program from the Samsung web site and extract it.
- 2 Double-click the **SetIPApplet.html** file in **cdroot/Linux/noarch/at\_opt/share/utils** folder.
- 3 Click to open the TCP/IP configuration window.
- 4 Enter the machine's new information into the configuration window. In a corporate intranet, you may need to have this information assigned by a network manager before proceeding.



Find the machine's MAC address from the **Network Configuration Report** (see "Printing a network configuration report" on page 150) and enter it without the colons. For example, 00:15:99:29:51:A8 becomes 0015992951A8.

- 5 The machine will automatically print the **Network Configuration Report**.

# Installing driver over the network



- Some features and optional goods may not be available depending on model or country (see "Features by model" on page 7).
- This feature is not available for the machine that does not support the network interface (see "Rear view" on page 23).
- You can install the printer driver and software when you insert the software CD into your CD-ROM drive.

For Windows, select the printer driver and software in the **Select Software to Install** window.

## Windows



The firewall software might be blocking network communication. Before connecting the device to the network, disable the computer's firewall.

- 1 Make sure that the machine is connected to the network and powered on. Also, your machine's IP address should have been set (see "Setting IP address" on page 150).

- 2 Insert the supplied software CD into your CD-ROM drive.

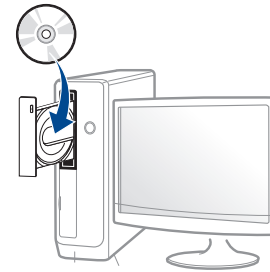

If the installation window does not appear, click **Start > All programs > Accessories > Run**.

X:\Setup.exe replacing "X" with the letter, which represents your CD-ROM drive and click **OK**.

- For Windows 8,  
If the installation window does not appear, from **Charms**, select **Search > Apps** and search for **Run**. Type in X:\Setup.exe, replacing "X" with the letter that represents your CD-ROM drive and click **OK**.  
If "**Tap to choose what happens with this disc.**" pop-up window appears, click the window and select **Run Setup.exe**.

- 3 Review and accept the installation agreements in the installation window. Then, click **Next**.
- 4 Select **Network connection** on the **Printer Connection Type** screen.
- 5 Follow the instructions in the installation window.

# Installing driver over the network

## From the Windows 8 Start Screen



- The V4 driver is automatically downloaded from the Windows Update if your computer is connected to the Internet. If not, you can manually download the V4 driver from Samsung website, <http://www.samsung.com> > find your product > Support or downloads.
- You can download **Samsung Printer Experience** app from the **Windows Store**. You need have a Microsoft account to use the Windows Store.
  - a From **Charms**, select **Search**.
  - b Click **Store**.
  - c Search and click **Samsung Printer Experience**.
  - d Click **Install**.
- If you install the driver using the supplied software CD, V4 driver is not installed. If you want to use the V4 driver in the **Desktop** screen, you can download from the Samsung website, <http://www.samsung.com> > find your product > Support or downloads.
- If you want to install Samsung's printer management tools, you need to install them using the supplied software CD.

- 1 Make sure that the machine is connected to the network and powered on. Also, your machine's IP address should have been set (see "Setting IP address" on page 150).
- 2 From **Charms**, select **Settings** > **Change PC settings** > **Devices**.
- 3 Click **Add a device**.  
Discovered machines will be shown on the screen.

- 4 Click the model name or host name you wish to use.



You can print a Network Configuration Report from the machine's control panel that will show the current machine's host name (see "Printing a network configuration report" on page 188).

- 5 The driver is automatically installed from the **Windows Update**.

# Installing driver over the network

## Silent installation Mode

Silent installation mode is an installation method that does not require any user intervention. Once you start the installation, the machine driver and software are automatically installed on your computer. You can start the silent installation by typing **/s** or **/S** in the command window.

## Command-line Parameters

Following table shows commands that can be used in the command window.



Following command-line are effective and operated when command is used with **/s** or **/S**. But **/h**, **/H** or **/?** are exceptional commands that can be operated solely.

Command- line	Definition	Description
<code>/s</code> or <code>/S</code>	Starts silent installation.	Installs machine drivers without prompting any UIs or user intervention.

Command- line	Definition	Description
<code>/p"&lt;port name&gt;"</code> or <code>/P"&lt;port name&gt;"</code>	<p>Specifies printer port.</p> <p> Network Port will be created by use of Standard TCP/IP Port monitor. For local port, this port must exist on system before being specified by command.</p>	<p>Printer port name can be specified as IP address, hostname, USB local port name, IEEE1284 port name or network path.</p> <p>For example:</p> <ul style="list-style-type: none"><li><code>/p"xxx.xxx.xxx.xxx"</code> in where, "xxx.xxx.xxx.xxx" means IP address for network printer. / <code>p"USB001"</code>, <code>/P"LPT1:"</code>, / <code>p"hostname"</code></li><li>/ <code>p"\\computer_name\shared_printer"</code> or <code>"\\xxx.xxx.xxx.xxx\shared_printer"</code> in where, <code>"\\computer_name\shared_printer"</code> or <code>"\\xxx.xxx.xxx.xxx\shared_printer"</code> means the network path to the printer by entering two slashes, the computer name or local IP address of the PC sharing the printer, and then the share name of the printer.</li></ul>

# Installing driver over the network

Command- line	Definition	Description
/a"<dest_path>" or /A"<dest_path>"	Specifies destination path for installation.   The destination path should be a fully qualified path.	Since machine drivers should be installed on the OS specific location, this command applies to only application software.
/n"<Printer name>" or /N"<Printer name>"	Specifies printer name. Printer instance shall be created as specified printer name.	With this parameter, you can add printer instances as your wishes.
/nd or /ND	Commands not to set the installed driver as a default machine driver.	It indicates installed machine driver will not be the default machine driver on your system if there are one or more printer drivers installed. If there is no installed machine driver on your system, then this option won't be applied because Windows OS will set installed printer driver as a default machine driver.

Command- line	Definition	Description
/x or /X	Uses existing machine driver files to create printer instance if it is already installed.	This command provides a way to install a printer instance that uses installed printer driver files without installing an additional driver.
/up"<printer name>" or /UP"<printer name>"	Removes only specified printer instance and not the driver files.	This command provides a way to remove only specified printer instance from your system without effecting other printer drivers. It will not remove printer driver files from your system.
/d or /D	Uninstalls all device drivers and applications from your system.	This command will remove all installed device drivers and application software from your system.
/v"<share name>" or /V"<share name>"	Shares installed machine and add other available platform drivers for Point & Print.	It will install all supported Windows OS platform's machine drivers to system and share it with specified <share name> for point and print.

# Installing driver over the network

Command- line	Definition	Description
/o or /O	Opens <b>Printers and Faxes</b> folder after installation.	This command will open <b>Printers and Faxes</b> folder after the silent installation.
/h, /H or /?	Shows Command-line Usage.	

## Mac

- 1 Make sure that the machine is connected to your network and powered on.
- 2 Insert the supplied software CD into your CD-ROM drive.

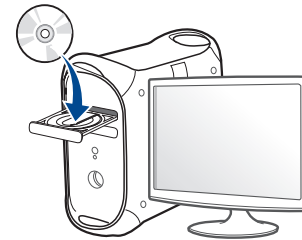

- 3 Double-click the CD-ROM icon that appears on your Mac desktop.
  - For Mac OS X 10.8, double-click the CD-ROM that appears on **Finder**.
- 4 Double-click the **MAC\_Installer** folder > **Installer OS X** icon.
- 5 Click **Continue**.
- 6 Read the license agreement and click **Continue**.
- 7 Click **Agree** to agree to the license agreement.
- 8 Click **Install**. All components necessary for machine operations will be installed.

If you click **Customize**, you can choose individual components to install.

# Installing driver over the network

- 9 Enter the password and click **OK**.
- 10 Select **Network Connected Printer(Wired or Wireless)** on the **Printer Connection Type** and click **Continue**.
- 11 Click **Add Printer** button to select your printer and add it to your printer list.
- 12 Click **IP** and select **HP Jetdirect - Socket** in **Protocol**.
- 13 Enter the machine's IP address in the **Address** input field.
- 14 Enter the queue name in the **Queue** input field. If you cannot determine the queue name for your machine server, try using the default queue first.
- 15 If Auto Select does not work properly, choose **Select Printer Software** and your machine name in **Print Using**.
- 16 Click **Add**.
- 17 After the installation is finished, click **Close**.

## Linux

You need to download Linux software packages from the Samsung website to install the printer software (<http://www.samsung.com>> find your product > Support or Downloads).

- 1 Make sure that the machine is connected to your network and powered on. Also, your machine's IP address should have been set.
- 2 Copy the Unified Linux Driver package to your system.
- 3 Open Terminal program and go to the folder that you copied the package to.
- 4 Extract the package.
- 5 Move to **uld** folder.
- 6 Execute **"./install.sh"** command (If you're not logged in as root, execute the command with **"sudo"** as **"sudo ./install.sh"**)
- 7 Proceed with the installation.
- 8 When the installation is finished, launch **Printing** utility(Go to **System > Administration > Printing** menu or execute **"system-config-printer"** command in Terminal program).
- 9 Click the **Add** button.



# Installing driver over the network

- 10 Select **AppSocket/HP JetDirect** and enter your machine's IP address.
- 11 Click the **Forward** button and add it to your system.

## UNIX



- Make sure your machine supports the UNIX operating system before installing the UNIX printer driver (see "Operating System" on page 7).
- The commands are marked with "", when typing the commands, do not type "".
- Some features and optional goods may not be available depending on model or country (see "Operating System" on page 7).

To use the UNIX printer driver, you have to install the UNIX printer driver package first, then setup the printer. You can download the UNIX printer driver package from the Samsung website (<http://www.samsung.com>> find your product > Support or Downloads).

## Installing the UNIX printer driver package

The installation procedure is common for all variants of UNIX OS mentioned.

- 1 From the Samsung website, download and unpack the UNIX Printer Driver package to your computer.

- 2 Acquire root privileges.  
"su -"
- 3 Copy the appropriate driver archive to the target UNIX computer.



See administration guide of your UNIX OS for details.

- 4 Unpack the UNIX printer driver package.  
For example, on IBM AIX, use the following commands.  
"gzip -d < enter the package name | tar xf -"
- 5 Go to the unpacked directory.
- 6 Run the install script.  
"./install -i"  
**install** is the installer script file which is used to install or uninstall the UNIX Printer Driver package.  
Use "**chmod 755 install**" command to give the permission to the installer script.
- 7 Execute the "**./install -c**" command to verify installation results.
- 8 Run "**installprinter**" from the command line. This will bring up the **Add Printer Wizard** window. Setup the printer in this window referring to the following procedures.

# Installing driver over the network



On some UNIX OS, for example on Solaris 10, just added printers may not be enabled and/or may not accept jobs. In this case run the following two commands on the root terminal:

```
"accept <printer_name>"
```

```
"enable <printer_name>"
```

## Uninstalling the printer driver package



The utility should be used to delete the printer installed in the system.

- a** Run "**uninstallprinter**" command from the terminal.  
It will open the **Uninstall Printer Wizard**.  
The installed printers are listed in the drop-down list.
- b** Select the printer to be deleted.
- c** Click **Delete** to delete the printer from the system.
- d** Execute the "**./install -d**" command to uninstall the whole package.
- e** To verify removal results, execute the "**./install -c**" command.

To re-install it, use the command "**./install -i**" to reinstall the binaries.

## Setting up the printer

To add the printer to your UNIX system, run 'installprinter' from the command line. This will bring up the Add Printer Wizard window. Setup the printer in this window according to the following steps:

- 1** Type the name of the printer.
- 2** Select the appropriate printer model from the model list.
- 3** Enter any description corresponding to the type of the printer in the **Type** field. This is optional.
- 4** Specify any printer description in the **Description** field. This is optional.
- 5** Specify the printer location in the **Location** field.
- 6** Type the IP address or DNS name of the printer in the **Device** textbox for network-connected printers. On IBM AIX with **jetdirect Queue type**, only the DNS name is possible-numeric IP address is not allowed.
- 7** **Queue type** shows the connection as **lpd** or **jetdirect** in the corresponding list box. Additionally, **usb** type is available on Sun Solaris OS.
- 8** Select **Copies** to set the number of copies.
- 9** Check the **Collate** option to receive copies already sorted.
- 10** Check the **Reverse Order** option to receive copies in the reverse order.

# Installing driver over the network

- 11 Check the **Make Default** option to set this printer as default.
- 12 Click **OK** to add the printer.

# IPv6 configuration



**IPv6** is supported properly only in Windows Vista or higher.



- Some features and optional goods may not be available depending on model or country (see "Features by model" on page 7 or "Menu overview" on page 33).
- If the IPv6 network seems to not be working, set all the network setting to the factory defaults and try again using **Clear Setting**.

The machine supports the following IPv6 addresses for network printing and managements.

- **Link-local Address:** Self-configured local IPv6 address (Address starts with FE80).
- **Stateless Address:** Automatically configured IPv6 address by a network router.
- **Stateful Address:** IPv6 address configured by a DHCPv6 server.
- **Manual Address:** Manually configured IPv6 address by a user.

In the IPv6 network environment, follow the next procedure to use the IPv6 address.

## From the control panel

### Activating IPv6



- Accessing menus may differ from model to model (see "Accessing the menu" on page 33).
- It may be necessary to press **OK** to navigate to lower-level menus for some models.

- 1 Select  (**Menu**) > **Network** > **TCP/IP (IPv6)** > **IPv6 Activate** on the control panel.
- 2 Select **On** and press **OK**.
- 3 Turn the machine off and turn it on again.



When you install the printer driver, do not configure both IPv4 and IPv6. We recommend to configure either IPv4 or IPv6.

# IPv6 configuration

## DHCPv6 address configuration

If you have a DHCPv6 server on your network, you can set one of the following options for default dynamic host configuration.



- Accessing menus may differ from model to model (see "Accessing the menu" on page 33).
- It may be necessary to press **OK** to navigate to lower-level menus for some models.

- 1 Select  (**Menu**) > **Network** > **TCP/IP (IPv6)** > **DHCPv6 Config** on the control panel.
- 2 Press **OK** to select the required value you want.
  - **DHCPv6 Addr.:** Always use DHCPv6 regardless of router request.
  - **DHCPv6 Off:** Never use DHCPv6 regardless of router request.
  - **Router:** Use DHCPv6 only when requested by a router.

## From the SyncThru™ Web Service

### Activating IPv6

- 1 Access a web browser, such as Internet Explorer, from Windows. Enter the machine IP address (<http://xxx.xxx.xxx.xxx>) in the address field and press the Enter key or click **Go**.
- 2 If it's your first time logging into **SyncThru™ Web Service** you need to log-in as an administrator. Type in the below default ID and password. We recommend you to change the default password for security reasons.
  - **ID: admin**
  - **Password: sec00000**
- 3 When the **SyncThru™ Web Service** window opens, move the mouse cursor over the **Settings** of the top menu bar and then click **Network Settings**.
- 4 Click **TCP/IPv6** on the left pane of the website.
- 5 Check the **IPv6 Protocol** check box to activate IPv6.
- 6 Click the **Apply** button.
- 7 Turn the machine off and turn it on again.

# IPv6 configuration



- You can also set the DHCPv6.
- To manually set the IPv6 address:  
Check the **Manual Address** check box. Then, the **Address/Prefix** text box is activated. Enter the rest of the address (e.g., :3FFE:10:88:194::**AAAA**. "A" is the hexadecimal 0 through 9, A through F).



Address must be enclosed in '[' ]' brackets.

## IPv6 address configuration

- 1 Start a web browser, such as Internet Explorer, that supports IPv6 addressing as a URL.
- 2 Select one of the IPv6 addresses (**Link-local Address**, **Stateless Address**, **Stateful Address**, **Manual Address**) from **Network Configuration Report** (see "Printing a network configuration report" on page 150).
  - **Link-local Address:** Self-configured local IPv6 address (Address starts with FE80).
  - **Stateless Address:** Automatically configured IPv6 address by a network router.
  - **Stateful Address:** IPv6 address configured by a DHCPv6 server.
  - **Manual Address:** Manually configured IPv6 address by a user.
- 3 Enter the IPv6 addresses (e.g., : http://[FE80::215:99FF:FE66:7701]).

# Wireless network setup



- Make sure your machine supports wireless networking. Wireless networking may not be available depending on the model (see "Features by model" on page 7).
- If the IPv6 network seems to not be working, set all the network settings to the factory defaults and try again using **Clear Setting**.

## Getting started

### Understanding your network type

Typically, you can only have one connection between your computer and the machine at a time.

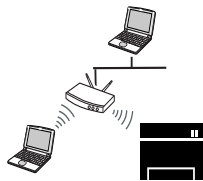

#### Infrastructure mode

This is an environment generally used for homes and SOHOs (Small Office/ Home Office). This mode uses an access point to communicate with the wireless machine.

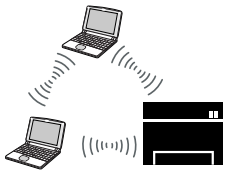

#### Ad hoc mode

This mode does not use an access point. The wireless computer and wireless machine communicate directly.

### Wireless network name and network password

Wireless networks require higher security, so when an access point is first set up, a network name (SSID), the type of security used, and a Network Password are created for the network. Ask your network administrator about this information before proceeding with the machine installation.



# Wireless network setup

## Introducing wireless set up methods

You can set wireless settings either from the machine or the computer. Choose the setting method from the below table.



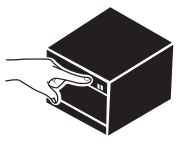

Some wireless network installation types may not be available depending on the model or country.

Set up method	Connecting method	Description & Reference
<b>With Access Point</b> 	<b>From the computer</b> 	Windows user, see "Access point via USB cable" on page 171.
		Windows user, see "Access point without a USB cable (recommended)" on page 174.
		<ul style="list-style-type: none"><li>• Mac user, see "Access point via USB cable" on page 179.</li><li>• Mac user, see "Access point without a USB cable (recommended)" on page 182.</li></ul>
	<b>From the machine's control panel</b> 	See "Using a network cable" on page 187.
		See "Machines with a display screen" on page 169.
		See "Using the menu button" on page 170.



# Wireless network setup

Set up method	Connecting method	Description & Reference
<b>Without Access Point</b> 	<b>From the computer</b>  Ad-hoc 	Windows user, see "Ad hoc via USB cable" on page 176. Mac user, see "Ad hoc via USB cable" on page 184.
	<b>Wi-Fi Direct setup</b>  Wi-Fi Direct 	See "Setting the Wi-Fi Direct for mobile printing" on page 190.



- If problems occur during wireless set up or driver installation, refer to the troubleshooting chapter (see "Troubleshooting for wireless network" on page 192).
- It is strongly recommended that you set the password on Access Points. If you do not set the password on Access Points, they might be exposed to illegal access from unknown machine including PCs, smart phones and printers. Refer to the Access Point user guide for password settings.

# Wireless network setup

## Using the WPS button

If your machine and an access point (or wireless router) support Wi-Fi Protected Setup™ (WPS), you can easily configure the wireless network settings by pressing the  (WPS) button on the control panel without a computer.





- If you want to use the wireless network using the infrastructure mode, make sure that the network cable is disconnected from the machine. Using the **WPS (PBC)** button or entering the PIN from the computer to connect to the access point (or wireless router) varies depending on the access point (or wireless router) you are using. Refer to the user's guide of the access point (or wireless router) you are using.
- When using the WPS button to set the wireless network, security settings may change. To prevent this, lock the WPS option for the current wireless security settings. The option name may differ depending on the access point (or wireless router) you are using.

## Items to prepare

- Check if the access point (or wireless router) supports Wi-Fi Protected Setup™ (WPS).
- Check if your machine supports Wi-Fi Protected Setup™ (WPS).
- Networked computer (PIN mode only)

## Choosing your type

There are two methods available to connect your machine to a wireless network using the  (WPS) button on the control panel.

The **Push Button Configuration (PBC)** method allows you to connect your machine to a wireless network by pressing both the  (WPS) button on the control panel of your machine and the WPS (PBC) button on a Wi-Fi Protected Setup™ WPS-enabled access point (or wireless router) respectively.

The **Personal Identification Number (PIN)** method helps you connect your machine to a wireless network by entering the supplied PIN information on a Wi-Fi Protected Setup™ WPS-enabled access point (or wireless router).

Factory default in your machine is **PBC** mode, which is recommended for a typical wireless network environment.



You can change the WPS mode from the control panel  (**Menu**) > **Network** > **Wireless** > **OK** > **WPS Setting**).

# Wireless network setup

## Machines with a display screen

---

### Connecting in PBC mode

- 1 Select  (Menu) > **Network** > **Wireless** > **WPS Setting** > **PBC** on the control panel.

Or press and hold the  (WPS) button on the control panel for more than 2 seconds.

The machine starts waiting for up to two minutes until you press the WPS (PBC) button on the access point (or wireless router).

- 2 Press the **WPS (PBC)** button on the access point (or wireless router).  
The messages are displayed on the display screen in the order below:
  - a **Connecting:** The machine is connecting to the access point (or wireless router).
  - b **Connected:** When the machine is successfully connected to the wireless network, the WPS LED light stays on.
  - c **AP SSID:** After completing the wireless network connection process, the AP's SSID information appears on the display.

- 3 Insert the supplied software CD into your CD-ROM drive, and follow the instructions in the window to set up the wireless network.

### Connecting in PIN mode

- 1 Select  (Menu) > **Network** > **Wireless** > **WPS Setting** > **PIN** on the control panel.

Or press and hold the  (WPS) button on the control panel for more than 2 seconds.

- 2 The eight-digit PIN appears on the display.

You need to enter the eight-digit PIN within two minutes on the computer that is connected to the access point (or wireless router).

The messages are displayed on the display screen in the order below:

- a **Connecting:** The machine is connecting to the wireless network.
- b **Connected:** When the machine is successfully connected to the wireless network, the WPS LED light stays on.
- c **SSID Type:** After completing the wireless network connection process, the AP's SSID information is displayed on the LCD display.

- 3 Insert the supplied software CD into your CD-ROM drive, and follow the instructions in the window to set up the wireless network.

### Re-connecting to a network

---

When the wireless function is off, the machine automatically tries to re-connect to the access point (or wireless router) with the previously used wireless connection settings and address.

# Wireless network setup



In the following cases, the machine automatically re-connects to the wireless network:

- The machine is turned off and on again.
- The access point (or wireless router) is turned off and on again.

## Canceling the connection process

To cancel the wireless network connection when the machine is connecting to the wireless network, press and release the  (**Stop/Clear**) on the control panel. **You need to wait 2 minutes to re-connect to the wireless network.**

## Disconnecting from a network

To disconnect the wireless network connection, press the  (WPS) button on the control panel for more than two seconds.

- **When the Wi-Fi network is in idle mode:** The machine is immediately disconnected from the wireless network and the WPS LED turns off.
- **When the Wi-Fi network is being used:** While the machine waits until the current job is finished, the light blinks fast on the WPS LED. Then, the wireless network connection is automatically disconnected and the WPS LED turns off.

## Using the menu button



Some menus may not appear in the display depending on options or models. If so, it is not applicable to your machine (see "Features by model" on page 7).

Before starting, you will need to know the network name (SSID) of your wireless network and the network key if it is encrypted. This information was set when the access point (or wireless router) was installed. If you do not know about your wireless environment, please ask the person who set up your network.



After completing the wireless network connection, you need to install a machine driver to print from an application (see "Installing driver over the network" on page 153).

- 1 Select  (**Menu**) > **Network** > **Wireless** > **WLAN Settings** on the control panel.
- 2 Press the **OK** to select the setup method you want.
  - **Wizard (recommended):** In this mode, the setup is automatic. The machine will display a list of available networks from which to choose. After a network is chosen then printer will prompt for the corresponding security key.

# Wireless network setup

- **Custom:** In this mode, users can give or edit manually their own SSID, or choose the security option in detail.

## Setup using Windows



Shortcut to the **Samsung Easy Wireless Setup** program without the CD: If you have installed the printer driver once, you can access the **Samsung Easy Wireless Setup** program without the CD (see "Accessing management tools" on page 262).

## Access point via USB cable

### Items to prepare

- Access point
- Network-connected computer
- Software CD that was provided with your machine
- A machine installed with a wireless network interface
- USB cable

## Creating the infrastructure network

- 1 Check whether the USB cable is connected to the machine.
- 2 Turn on your computer, access point, and machine.
- 3 Insert the supplied software CD into your CD-ROM drive.

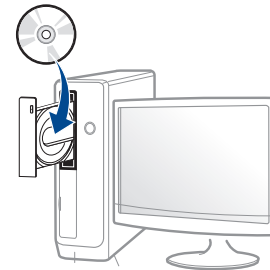

If the installation window does not appear, click **Start > All programs > Accessories > Run**.

X:\Setup.exe replacing "X" with the letter, which represents your CD-ROM drive and click **OK**.

- For Windows 8,

If the installation window does not appear, from **Charms**, select **Search > Apps** and search for **Run**. Type in X:\Setup.exe, replacing "X" with the letter that represents your CD-ROM drive and click **OK**.

If "Tap to choose what happens with this disc." pop-up window appears, click the window and select **Run Setup.exe**.

- 4 Review and accept the installation agreements in the installation window. Then, click **Next**.

# Wireless network setup

- 5 Select **Wireless network connection** on the **Printer Connection Type** screen. Then, click **Next**.

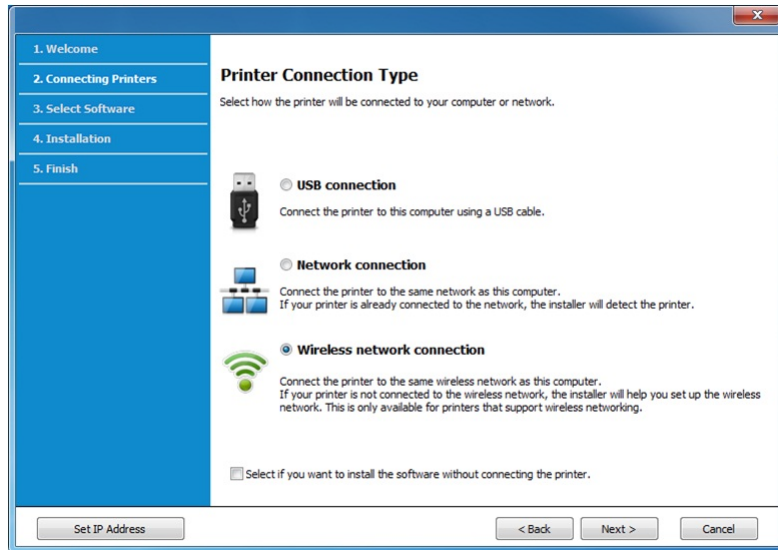

- 6 On the **Are you setting up your printer for the first time?** screen, select **Yes, I will set up my printer's wireless network**. Then, click **Next**.

If your printer is already connected on the network, select **No, my printer is already connected to my network**.

- 7 Select **Using a USB cable** on the **Select the Wireless Setup Method** screen. Then, click **Next**.

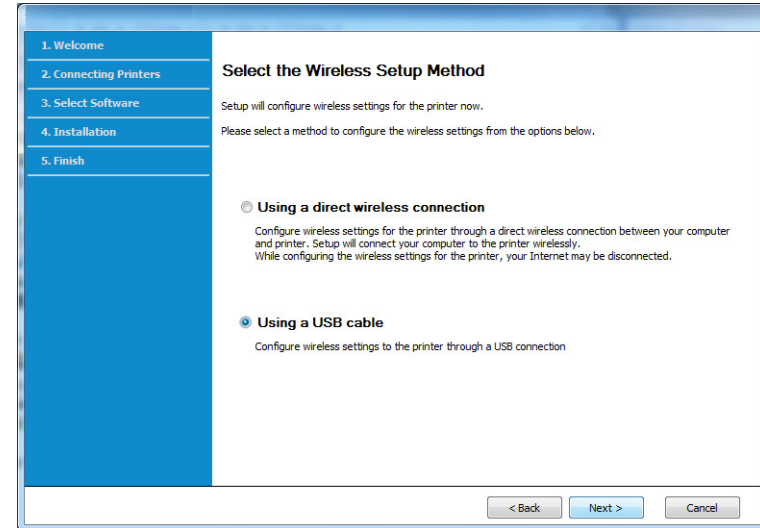

# Wireless network setup

- 8 After searching, the window shows the wireless network devices. Select the name (SSID) of the access point you want to use and click **Next**.

If you cannot find the network name you want to choose, or if you want to set the wireless configuration manually, click **Advanced Setting**.

- **Enter the wireless Network Name:** Enter the SSID of the access point (SSID is case-sensitive).
- **Operation Mode:** Select **Infrastructure**.
- **Authentication:** Select an authentication type.
  - Open System:** Authentication is not used, and encryption may or may not be used, depending on the need for data security.
  - Shared Key:** Authentication is used. A device that has a proper WEP key can access the network.
  - WPA Personal or WPA2 Personal:** Select this option to authenticate the print server based on a WPA Pre-Shared Key. This uses a shared secret key (generally called Pre Shared Key pass phrase), which is manually configured on the access point and each of its clients.
- **Encryption:** Select the encryption (None, WEP64, WEP128, TKIP, AES, TKIP AES).
- **Network Password:** Enter the encryption network password value.
- **Confirm Network Password:** Confirm the encryption network password value.
- **WEP Key Index:** If you are using WEP Encryption, select the appropriate **WEP Key Index**.



The wireless network security window appears when the access point has security settings.

Enter the Network Password of the access point (or router).

- 9 If your printer supports Wi-Fi Direct and this function is disabled, its corresponding screen will appear.

Click **OK** and **Next**.

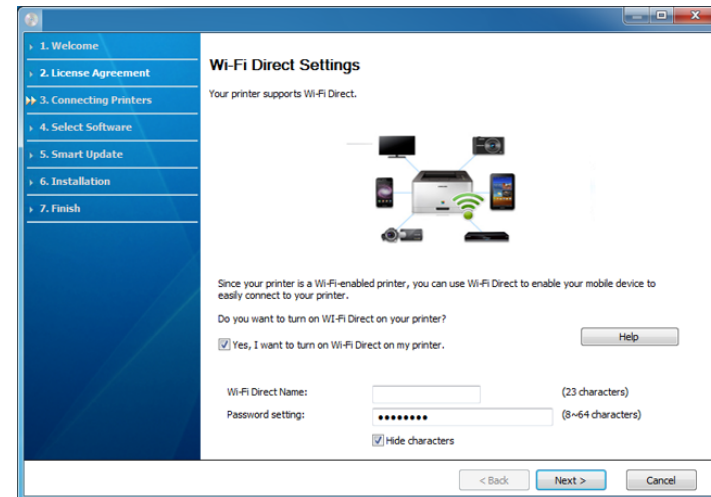

# Wireless network setup



- Wi-Fi Direct option appears on the screen only if your printer supports this feature.
- Can start to build Wi-Fi Direct by using Samsung Easy Printer Manager (see "Setting up Wi-Fi Direct" on page 191).
- **Wi-Fi Direct Name:** The default Wi-Fi Direct Name is the model name and the maximum length is 22 characters.
- **Password setting** is the numeric string, and the size is 8 ~ 64 characters.

**10** When the wireless network set up is completed, disconnect the USB cable between the computer and machine. Click **Next**.

**11** Follow the instructions in the installation window.

## Access point without a USB cable (recommended)

### Items to prepare

- WiFi-enabled PC running Windows 7 or higher and an access point (router)
- Software CD that was provided with your machine
- A machine installed with a wireless network interface



While setting the wireless network, the machine uses PC's wireless LAN. You might not be able to connect to the Internet.

## Creating the infrastructure network

- 1** Turn on your computer, access point, and machine.
- 2** Insert the supplied software CD into your CD-ROM drive.

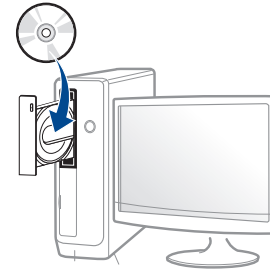

If the installation window does not appear, click **Start > All programs > Accessories > Run**.

X:\Setup.exe replacing "X" with the letter, which represents your CD-ROM drive and click **OK**.

- For Windows 8,  
If the installation window does not appear, from **Charms**, select **Search > Apps** and search for **Run**. Type in X:\Setup.exe, replacing "X" with the letter that represents your CD-ROM drive and click **OK**.  
If "**Tap to choose what happens with this disc.**" pop-up window appears, click the window and select **Run Setup.exe**.

- 3** Review and accept the installation agreements in the installation window. Then, click **Next**.



# Wireless network setup

- 4 Select **Wireless network connection** on the **Printer Connection Type** screen. Then, click **Next**.

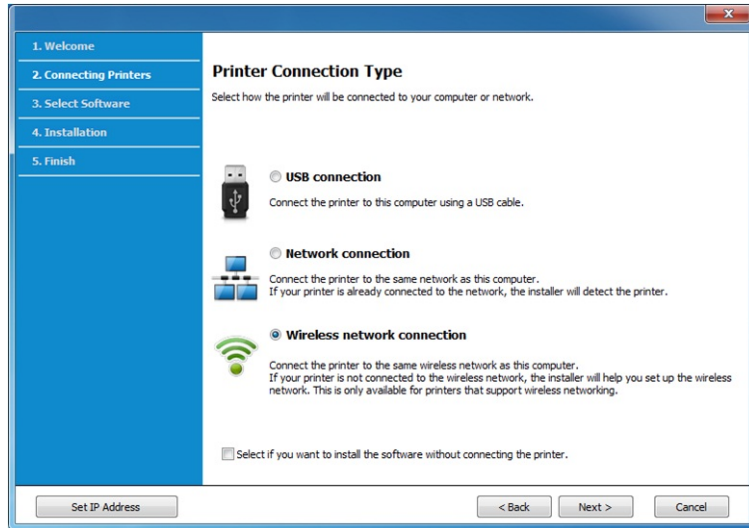

- 5 On the **Are you setting up your printer for the first time?** screen, select **Yes, I will set up my printer's wireless network**. Then, click **Next**.

If your printer is already connected on the network, select **No, my printer is already connected to my network**.

- 6 Select **Using a direct wireless connection** on the **Select the Wireless Setup Method** screen. Then, click **Next**.

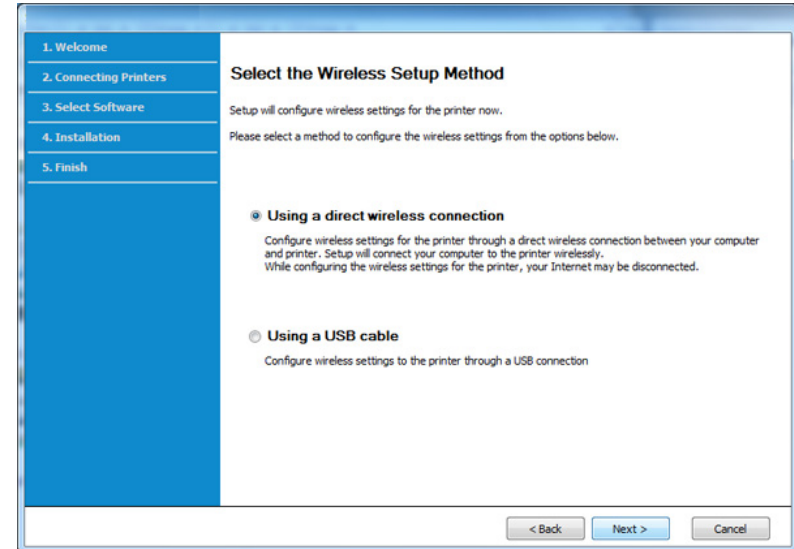

# Wireless network setup



Even if your computer is running Windows 7 or higher, you cannot use this feature if your PC does not support wireless network. Set the wireless network using a USB cable (see "Access point via USB cable" on page 171).

If below screen appears, press the  (WPS) button from the control panel within 2 minutes.

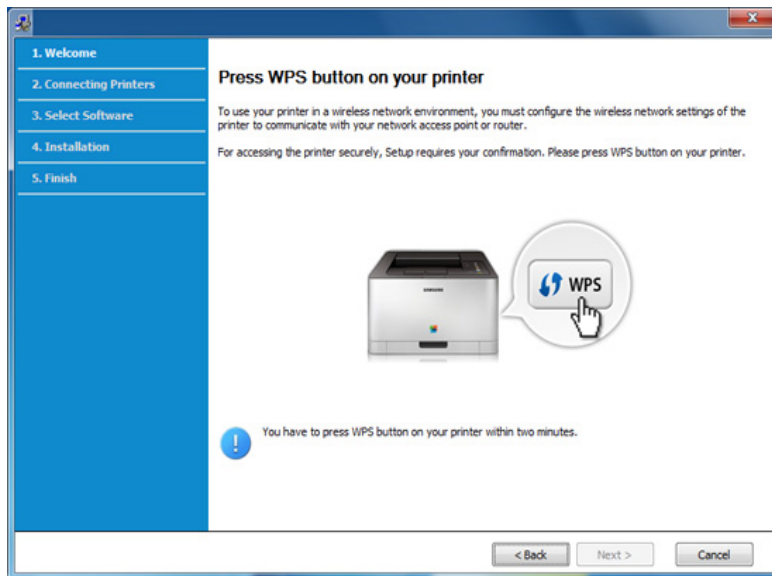

7 When the wireless network set up is completed, click **Next**.

8 Follow the instructions in the installation window.

## Ad hoc via USB cable

If you do not have an access point (AP), you may still connect the machine wirelessly to your computer by setting up an ad-hoc wireless network by following the simple steps below.

### Items to prepare

- Network-connected computer
- Software CD that was provided with your machine
- A machine installed with a wireless network interface
- USB cable

# Wireless network setup

## Creating the ad hoc network in Windows

- 1 Turn on your computer and the wireless network machine.
- 2 Insert the supplied software CD into your CD-ROM drive.



If the installation window does not appear, click **Start > All programs > Accessories > Run**.

X:\Setup.exe replacing "X" with the letter, which represents your CD-ROM drive and click **OK**.

- For Windows 8,

If the installation window does not appear, from **Charms**, select **Search > Apps** and search for **Run**. Type in X:\Setup.exe, replacing "X" with the letter that represents your CD-ROM drive and click **OK**.

If "**Tap to choose what happens with this disc.**" pop-up window appears, click the window and select **Run Setup.exe**.

- 3 Review and accept the installation agreements in the installation window. Then, click **Next**.

- 4 Select **Wireless network connection** on the **Printer Connection Type** screen. Then, click **Next**.

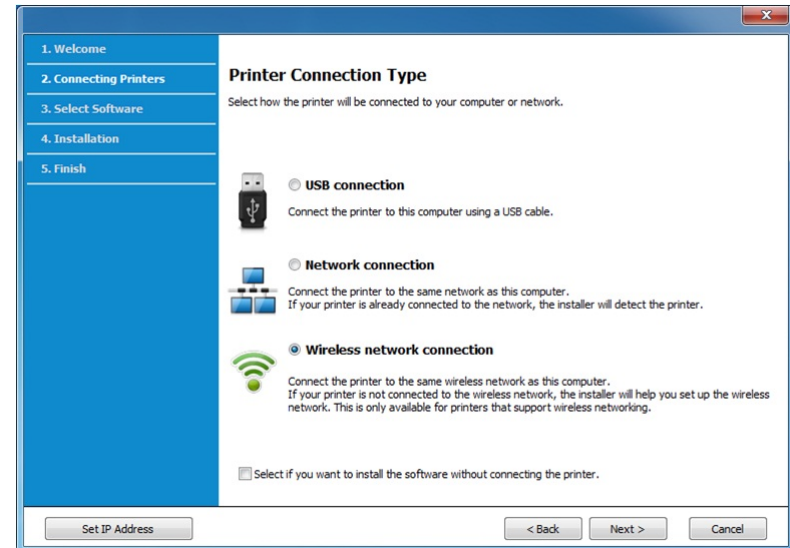

- 5 On the **Are you setting up your printer for the first time?** screen, select **Yes, I will set up my printer's wireless network**. Then, click **Next**.

If your printer is already connected on the network, select **No, my printer is already connected to my network**.

- 6 Select **Using a USB cable** on the **Select the Wireless Setup Method** screen. Then, click **Next**.

# Wireless network setup

- 7 After searching the wireless networks, a list of wireless networks your machine has searched appears. Click **Advanced Setting**.



- **Enter the wireless Network Name:** Enter the SSID name you want (SSID is case-sensitive).
- **Operation Mode:** Select ad hoc.
- **Channel:** Select the channel. (**Auto Setting** or 2412 MHz to 2467 MHz).
- **Authentication:** Select an authentication type.  
**Open System:** Authentication is not used, and encryption may or may not be used, depending on the need for data security.  
**Shared Key:** Authentication is used. A device that has a proper WEP key can access the network.
- **Encryption:** Select the encryption (None, WEP64, WEP128).
- **Network Password:** Enter the encryption network password value.
- **Confirm Network Password:** Confirm the encryption network password value.
- **WEP Key Index:** If you are using WEP Encryption, select the appropriate **WEP Key Index**.

The wireless network security window appears when the ad hoc network has security enabled.

Select **Open System** or **Shared Key** for the authentication and click **Next**.

- WEP (Wired Equivalent Privacy) is a security protocol preventing unauthorized access to your wireless network. WEP encrypts the data portion of each packet exchanged on a wireless network using a 64-bit or 128-bit WEP encryption key.

- 8 The window showing the wireless network setting appears. Check the settings and click **Next**.



Before entering the IP address for the machine, you must know the computer's network configuration information. If the computer's network configuration is set to DHCP, the wireless network setting should also be DHCP. Likewise, if the computer's network configuration is set to Static, the wireless network setting should also be Static.

If your computer is set to DHCP and you want to use the Static wireless network setting, you must contact the network administrator to get the static IP address.

- **For the DHCP method**

If the IP address assignment method is DHCP, check if DHCP is shown in the **Wireless Network Setting Confirm** window. If it shows Static, click **Change TCP/IP** to change the assignment method to **Receive IP address automatically (DHCP)**.

- **For the Static method**

If the IP address assignment method is Static, check if Static is shown in the **Wireless Network Setting Confirm** window. If it shows DHCP, click **Change TCP/IP** to enter the IP address and other network configuration values for the machine.

For example,

If the computer's network information is as shown follows:

- IP address: 169.254.133.42
- Subnet Mask: 255.255.0.0

Then, the machine's network information should be as below:

- IP address: 169.254.133.**43**

# Wireless network setup

- Subnet Mask: 255.255.0.0 (Use the computer's subnet mask.)
- Gateway: 169.254.133.1

- 9 The **Wireless Network Setting Complete** window appears. Click **Next**.
- 10 When the wireless network settings are completed, disconnect the USB cable between the computer and machine. Click **Next**.
- 11 Follow the instructions in the installation window.

## Setup using Mac

### Access point via USB cable

#### Items to prepare

- Access point
- Network-connected printer
- Software CD that was provided with your machine
- A machine installed with a wireless network interface
- USB cable

- 1 Make sure that the machine is connected to your computer and powered on.
- 2 Insert the supplied software CD into your CD-ROM drive.

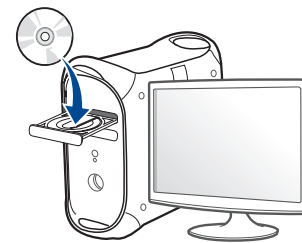

# Wireless network setup

- 3 Double-click the CD-ROM icon that appears on your Mac desktop.
  - For Mac OS X 10.8, double-click the CD-ROM that appears on **Finder**.
- 4 Double-click the **MAC\_Installer** folder > **Installer OS X** icon.
- 5 Click **Continue**.
- 6 Read the license agreement and click **Continue**.
- 7 Click **Agree** to agree to the license agreement.
- 8 Click **Install**. All components necessary for machine operations will be installed.

If you click **Customize**, you can choose individual components to install.
- 9 Enter the password and click **OK**.

- 10 Select **Configuration of Wireless network** on the **Printer Connection Type** and click **Continue**.

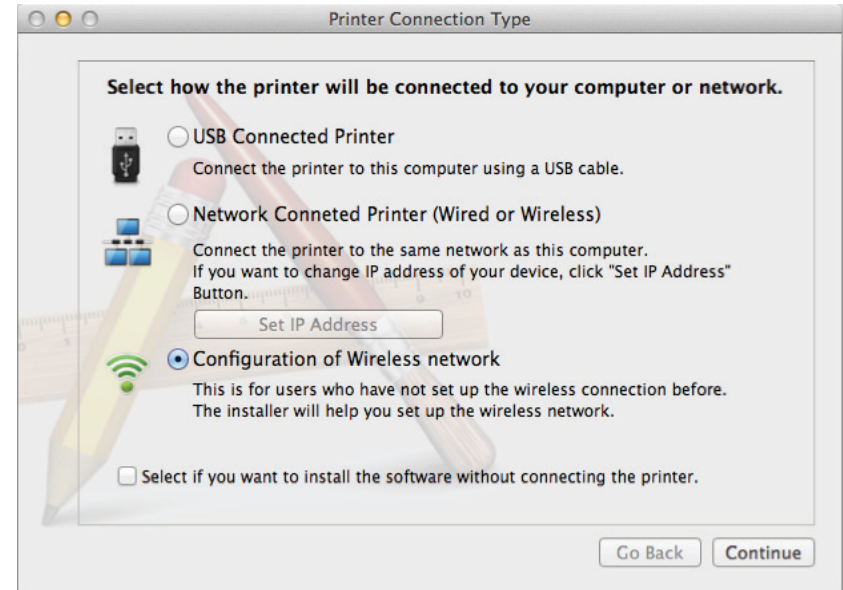

# Wireless network setup

- 11** If **Wireless Settings** screen appears, select **Using a USB cable** and click **Next**.

If the screen does not appear, go to step 15.

Wireless Settings

### Select the Wireless Setup Method

Setup will configure wireless settings for the printer now.  
Please select a method to configure the wireless settings from the options below.

Using a direct wireless connection

Configure wireless settings for the printer through a direct wireless connection between your computer and printer. Setup will connect your computer to the printer wirelessly.  
While configuring the wireless settings for the printer, your Internet may be disconnected.

Using a USB cable

Configure wireless settings to the printer through a USB connection

< Back    Next >    Cancel

- 12** After searching, the window shows the wireless network devices. Select the name (SSID) of the access point you want to use and click **Next**.



When you set the wireless configuration manually, click **Advanced Setting**.

- **Enter the wireless Network Name:** Enter the SSID of the access point (SSID is case-sensitive).
- **Operation Mode:** Select **Infrastructure**.
- **Authentication:** Select an authentication type.
  - Open System:** Authentication is not used, and encryption may or may not be used, depending on the need for data security.
  - Shared Key:** Authentication is used. A device that has a proper WEP key can access the network.
  - WPA Personal or WPA2 Personal:** Select this option to authenticate the print server based on the WPA Pre-Shared Key. This uses a shared secret key (generally called Pre Shared Key pass phrase) that is manually configured on the access point and each of its clients.
- **Encryption:** Select the encryption. (None, WEP64, WEP128, TKIP, AES, TKIP, AES)
- **Network Password:** Enter the encryption network password value.
- **Confirm Network Password:** Confirm the encryption network password value.
- **WEP Key Index:** If you are using WEP Encryption, select the appropriate **WEP Key Index**.

The wireless network security window appears when the access point has security enabled.

Enter the Network Password of the access point (or router).

# Wireless network setup

- 13** The window showing the wireless network setting appears. Check the settings and click **Next**.



- Wi-Fi Direct option appears on the screen only if your printer supports this feature.
- Can start to build Wi-Fi Direct by using Samsung Easy Printer Manager (see "Setting up Wi-Fi Direct" on page 191).
- **Wi-Fi Direct Name:** The default Wi-Fi Direct Name is the model name and the maximum length is 22 characters.
- **Password setting** is the numeric string, and the size is 8 ~ 64 characters.

- 14** The **Wireless Network Setting Complete** window appears. Click **Next**.

- 15** When the wireless network settings are completed, disconnect the USB cable between the computer and machine. Click **Next**.

## Access point without a USB cable (recommended)

### Items to prepare

- WiFi-enabled Mac running Mac OS 10.7 or higher and an access point (router)
- Software CD that was provided with your machine
- A machine installed with a wireless network interface

- 1** Make sure that the machine is connected to your computer and powered on.

- 2** Insert the supplied software CD into your CD-ROM drive.

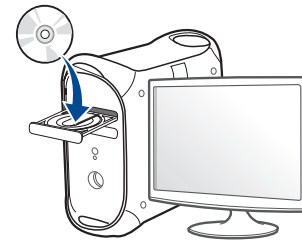

- 3** Double-click the CD-ROM icon that appears on your Mac desktop.

- For Mac OS X 10.8, double-click the CD-ROM that appears on **Finder**.

- 4** Double-click the **MAC\_Installer** folder > **Installer OS X** icon.

- 5** Click **Continue**.



# Wireless network setup

6 Read the license agreement and click **Continue**.

7 Click **Agree** to agree to the license agreement.

8 Click **Install**. All components necessary for machine operations will be installed.

If you click **Customize**, you can choose individual components to install.

9 Enter the password and click **OK**.

10 Select **Configuration of Wireless network** on the **Printer Connection Type** and click **Continue**.

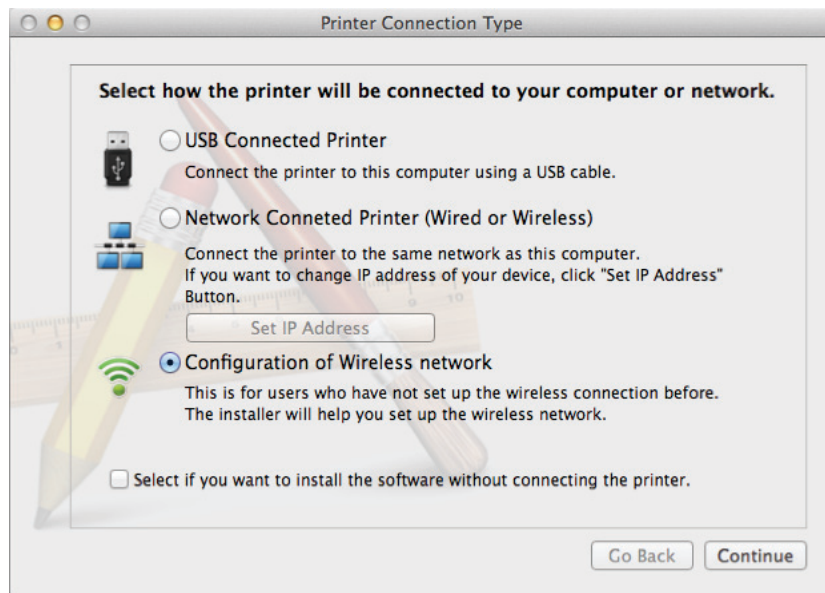

11 If **Wireless Settings** screen appears, select **Using a direct wireless connection** and click **Next**.

If the screen does not appear, go to step 13.

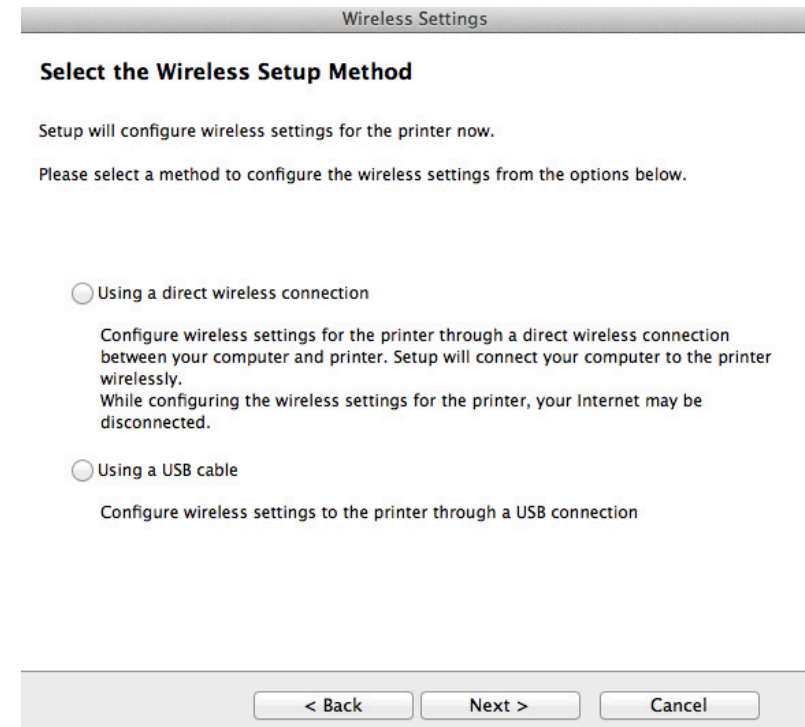

# Wireless network setup



If below screen appears, press the  (WPS) button from the control panel within 2 minutes.



**12** When the wireless network set up is completed, click **Next**.

**13** After the installation is finished, click **Close**.

## Ad hoc via USB cable

If you do not have an access point (AP), you may still connect the machine wirelessly to your computer by setting up an ad hoc wireless network by following these simple directions.

### Items to prepare

- Network-connected computer
- Software CD that was provided with your machine
- A machine installed with a wireless network interface
- USB cable

### Creating the ad hoc network in Mac

- 1** Make sure that the machine is connected to your computer and powered on.
- 2** Insert the supplied software CD into your CD-ROM drive.

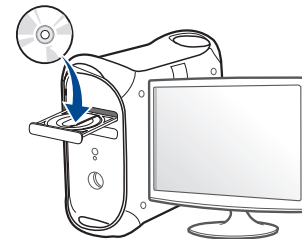

# Wireless network setup

- 3 Double-click the CD-ROM icon that appears on your Mac desktop.
  - For Mac OS X 10.8, double-click the CD-ROM that appears on **Finder**.
- 4 Double-click the **MAC\_Installer** folder > **Installer OS X** icon.
- 5 Click **Continue**.
- 6 Read the license agreement and click **Continue**.
- 7 Click **Agree** to agree to the license agreement.
- 8 Click **Install**. All components necessary for machine operations will be installed.

If you click **Customize**, you can choose individual components to install.
- 9 Enter the password and click **OK**.

- 10 Select **Configuration of Wireless network** on the **Printer Connection Type** and click **Continue**.

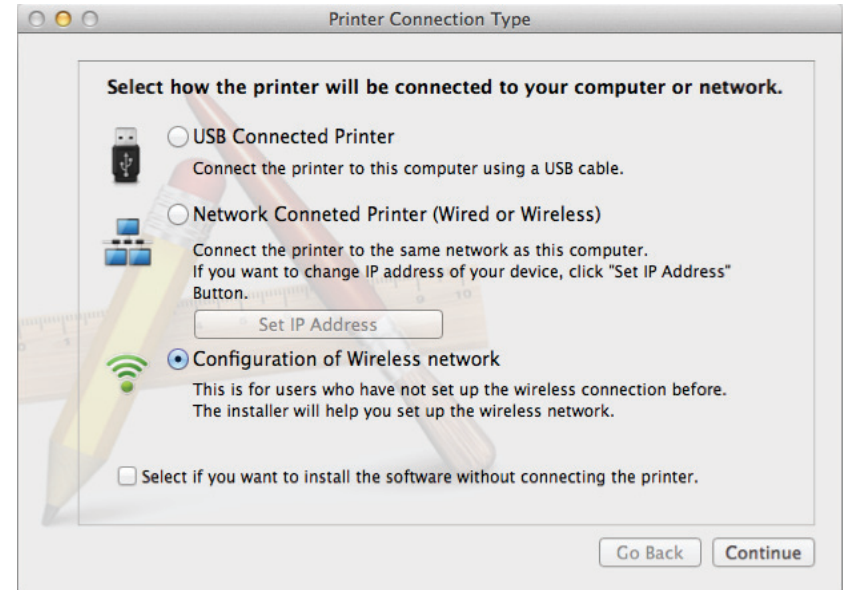

# Wireless network setup

- 11** After searching the wireless networks, a list of wireless networks your machine has searched appears. Click **Advanced Setting**.



- **Enter the wireless Network Name:** Enter the SSID name (SSID is case-sensitive).
- **Operation Mode:** Select ad hoc.
- **Channel:** Select the channel (**Auto Setting** or 2412 MHz to 2467 MHz).
- **Authentication:** Select an authentication type.  
**Open System:** Authentication is not used, and encryption may or may not be used, depending on the need for data security.  
**Shared Key:** Authentication is used. A device that has a proper WEP key can access the network.
- **Encryption:** Select the encryption (None, WEP64, WEP128).
- **Network Password:** Enter the encryption network password value.
- **Confirm Network Password:** Confirm the encryption network password value.
- **WEP Key Index:** If you are using WEP Encryption, select the appropriate **WEP Key Index**.

The wireless network security window appears when the ad hoc network has security setting.

Select **Open System** or **Shared Key** for the authentication and click **Next**.

- WEP (Wired Equivalent Privacy) is a security protocol preventing unauthorized access to your wireless network. WEP encrypts the data portion of each packet exchanged on a wireless network using a 64-bit or 128-bit WEP encryption key.

- 12** The window showing the wireless network settings appears. Check the settings and click **Next**.



Before entering the IP address for the machine, you must know the computer's network configuration information. If the computer's network configuration is set to DHCP, the wireless network setting should also be DHCP. Likewise, if the computer's network configuration is set to Static, the wireless network setting should also be Static.

If your computer is set to DHCP and you want to use Static wireless network setting, you must contact the network administrator to get the static IP address.

- **For the DHCP method**

If the IP address assignment method is DHCP, check if DHCP is shown in the **Wireless Network Setting Confirm** window. If it shows Static, click **Change TCP/IP** to change the assignment method to **Receive IP address automatically (DHCP)**.

- **For the Static method**

If the IP address assignment method is Static, check if Static is shown in the **Wireless Network Setting Confirm** window. If it shows DHCP, click **Change TCP/IP** to enter the IP address and other network configuration values for the machine.

For example,

If the computer's network information is shown as follows:

- IP address: 169.254.133.42
- Subnet Mask: 255.255.0.0

Then, the machine's network information should be as shown below:

- IP address: 169.254.133.**43**

# Wireless network setup

- Subnet Mask: 255.255.0.0 (Use the computer's subnet mask.)
- Gateway: 169.254.133.1

**13** When the window that tells you that the network cable connection is confirmed appears, disconnect the network cable and click **Next**.

If the network cable is connected, it may have trouble finding the machine when configuring the wireless network.

**14** The wireless network connects according to the network configuration.

**15** Wireless network set up is completed. After installation is finished, click **Quit**.



After completing the wireless network connection, you need to install a machine driver to print from an application (see "Installation for Mac" on page 144).

## Using a network cable



Machines that do not support the network port will not be able to use this feature (see "Rear view" on page 23).

Your machine is a network compatible machine. To enable your machine to work with your network, you will need to perform some configuration procedures.



- After completing the wireless network connection, you need to install a machine driver to print from an application (see "Installing driver over the network" on page 153).
- See your network administrator, or the person that set up your wireless network, for information about your network configuration.

## Items to prepare

- Access point
- Network-connected computer
- Software CD that was provided with your machine
- A machine installed with a wireless network interface
- Network cable

# Wireless network setup

## Printing a network configuration report

---

You can identify the network settings of your machine by printing a network configuration report.

See "Printing a network configuration report" on page 150.

## IP setting using SetIP Program (Windows)

---

This program is used to manually set the network IP address of your machine using its MAC address to communicate with the machine. The MAC address is the hardware serial number of the network interface and can be found in the **Network Configuration Report**.

See "Setting IP address" on page 150.

## Configuring the machine's wireless network

---

Before starting you will need to know the network name (SSID) of your wireless network and the network key if it is encrypted. This information was set when the access point (or wireless router) was installed. If you do not know about your wireless environment, please ask the person who set up your network.

To configure wireless parameters, you can use **SyncThru™ Web Service**.

## Using SyncThru™ Web Service

---

Before starting wireless parameter configuration, check the cable connection status.

- 1 Check whether or not the network cable is connected to the machine. If not, connect the machine with a standard network cable.
- 2 Start a web browser such as Internet Explorer, Safari, or Firefox and enter your machine's new IP address in the browser window.

For example,



http://192.168.1.133/

- 3 Click **Login** on the upper right of the SyncThru™ Web Service website.
- 4 Type in the **ID** and **Password** then click **Login**. We recommend you to change the default password for security reasons.
  - **ID: admin**
  - **Password: sec00000**
- 5 When the **SyncThru™ Web Service** window opens, click **Network Settings**.
- 6 Click **Wireless > Wizard**.

# Wireless network setup



**Wizard** will help you setup the wireless network configuration. However, if you want to set the wireless network directly, select **Custom**.

**7** Select the one **Network Name(SSID)** in the list.

- **SSID:** SSID (Service Set Identifier) is a name that identifies a wireless network, access points, and wireless devices attempting to connect to a specific wireless network must use the same SSID. The SSID is case sensitive.
- **Operation Mode:** **Operation Mode** refers to the type of wireless connections (see "Wireless network name and network password" on page 165).
  - **Ad-hoc:** Allows wireless devices to communicate directly with each other in a peer-to-peer environment.
  - **Infrastructure:** Allows wireless devices to communicate with each other through an access point.



If your network's **Operation Mode** is **Infrastructure**, select the SSID of the access point. If the **Operation Mode** is **Ad-hoc**, select the machine's SSID.

**8** Click **Next**.

If the wireless security setting window appears, enter the registered password (network password) and click **Next**.

**9**

The confirmation window appears, please check your wireless setup. If the setup is right, click **Apply**.



Disconnect the network cable (standard or network). Your machine should then start communicating wirelessly with the network. In case of Ad-hoc mode, you can use a wireless LAN and wired LAN simultaneously.

**10**

Insert the supplied software CD into your CD-ROM drive, and follow the instructions in the window to set up the wireless network.

# Wireless network setup

## Turning the Wi-Fi network on/off



If your machine has a display, you can also turn on/off the Wi-Fi from the machine's control panel using the **Network** menu.

- 1 Check whether the network cable is connected to the machine. If not, connect the machine with a standard network cable.
- 2 Start a web browser such as Internet Explorer, Safari, or Firefox and enter your machine's new IP address in the browser window.

For example,



- 3 Click **Login** on the upper right of the SyncThru™ Web Service website.
- 4 Type in the **ID** and **Password**, then click **Login**. We recommend you to change the default password for security reasons.
  - **ID: admin**
  - **Password: sec00000**
- 5 When the **SyncThru™ Web Service** window opens, click **Network Settings**.

- 6 Click **Wireless > Custom**.

You can also turn the Wi-Fi network on/off.

## Setting the Wi-Fi Direct for mobile printing

Wi-Fi Direct is an easy-to-setup peer-to-peer connection method between the Wi-Fi Direct certified printer and a mobile device that provides a secure connection and better throughput than ad hoc mode.

With Wi-Fi Direct, you can connect your printer to a Wi-Fi Direct network while concurrently connecting to an access point. You can also use a wired network and a Wi-Fi Direct network simultaneously so multiple users can access and print documents both from Wi-Fi Direct and from a wired network.



- You cannot connect your mobile device to the internet through the printer's Wi-Fi Direct.
- The supported protocol list may differ from your model, Wi-Fi Direct networks do NOT support IPv6, network filtering, IPSec, WINS, and SLP services.
- The maximum number of devices that can be connected via Wi-Fi Direct is 3.



# Wireless network setup

## Setting up Wi-Fi Direct

You can enable Wi-Fi Direct feature by one of the following methods.

### From the USB cable-connected computer(recommended)

After the driver installation is complete, Samsung Easy Printer Manager can be used to change Wi-Fi Direct settings.



Samsung Easy Printer Manager is Available for Windows and Mac OS users only.

- From the **Start** menu, select **Programs** or **All Programs** > **Samsung Printers** > Samsung Easy Printer Manager > **Device Settings** > **Network**.
  - **Wi-Fi Direct On/Off:** Select **On** to enable.
  - **Device Name:** Enter the printer's name for searching for your printer on a wireless network. By default, the device name is the model name.
  - **IP Address:** Enter the IP address of the printer. This IP address is used only for the local network and not for the infrastructure wired or wireless network. We recommend using the default local IP address (the default local IP address of the printer for Wi-Fi Direct is 192.168.3.1 )
  - **Group Owner:** Activate this option to assign the printer the Wi-Fi Direct group's owner. The **Group Owner** acts similar to a wireless access point. We recommend activating this option.

- **Network Password:** If your printer is a **Group Owner**, a **Network Password** is required for other mobile devices to connect to your printer. You can configure a network password yourself, or can remember the given Network Password that is randomly generated by default.

### From the machine (Machines with a display screen)



Accessing menus may differ from model to model (see "Accessing the menu" on page 33 ).

- Select  **(Menu)** > **Network** > **Wireless** > **Wi-Fi Direct** on the control panel.
- Enable **Wi-Fi Direct**.

### From the network-connected computer

If your printer is using a network cable or a wireless access point, you can enable and configure Wi-Fi Direct from SyncThru™ Web Service.

- Access **SyncThru™ Web Service**, select **Settings** > **Network Settings** > **Wireless** > **Wi-Fi Direct**.
- Enable or disable **Wi-Fi Direct** and set other options.

# Wireless network setup



- For Linux OS users,
  - Print an IP network configuration report to check the output (see "Printing a network configuration report" on page 150).
  - Access **SyncThru Web Service**, select **Settings > Network Settings > Wireless > Wi-Fi Direct**.
  - Enable or disable **Wi-Fi Direct**.

## Setting up the mobile device

- After setting up Wi-Fi Direct from the printer, refer to the user manual of the mobile device you are using to set its Wi-Fi Direct.
- After setting up Wi-Fi Direct, you need to download the mobile printing application (For example: Samsung Mobile printer) to print from your smartphone.



- When you have found the printer you want to connect to from your mobile device, select the printer and the printer's LED will blink. Press the WPS button on the printer and it will be connected to your mobile device.
- If your mobile device does not support Wi-Fi Direct, you need to enter the "Network Key" of a printer instead of pushing the WPS button.

## Troubleshooting for wireless network

### Problems during setup or driver installation

#### Printers Not Found

- Your machine may not be turned on. Turn on your computer and the machine.
- USB cable is not connected between your computer and machine. Connect the machine to your computer using the USB cable.
- The machine does not support wireless networking (see "Features by model" on page 7).

#### Connecting Failure - SSID Not Found

- The machine is unable to find the network name (SSID) you have selected or entered. Check the network name (SSID) on your access point and try connecting again.
- Your access point is not turned on. Turn on your access point.

# Wireless network setup

## Connecting Failure - Invalid Security

- Security is not configured correctly. Check the configured security on your access point and machine.

## Connecting Failure - General Connection Error

- Your computer is not receiving a signal from your machine. Check the USB cable and your machine's power.

## Connecting Failure - Connected Wired Network

- Your machine is connected with a wired network cable. Remove the wired network cable from your machine.

## Connecting Failure - Assigning the IP address

- Cycle the power for the access point (or wireless router) and machine.

## PC Connection Error

- The configured network address is unable to connect between your computer and machine.
  - For a DHCP network environment  
The machine receives the IP address automatically (DHCP) when computer is configured to DHCP.



If the printing job is not working in DHCP mode, the problem may be caused by the automatically changed IP address. Compare the IP address between the product's IP address and the printer port's IP address.

### How to compare:

- 1 Print the network information report of your printer, and then check the IP address (see "Printing a network configuration report" on page 150).
- 2 Check the printer port's IP address from your computer.
  - a Click the Windows **Start** menu.
    - For Windows 8, from **Charms**, select **Search > Settings**.
  - b For Windows XP/Server 2003, select **Printer and Faxes**.
    - For Windows Server 2008/Vista, select **Control Panel > Hardware and Sound > Printers**.
    - For Windows 7/8, select **Control Panel > Devices and Printers**.
    - For Windows Server 2008 R2, select **Control Panel > Hardware > Devices and Printers**.
  - c Right-click your machine.
  - d For Windows XP/2003/2008/Vista, press **Properties**.  
For Windows 7/8 and Windows Server 2008 R2, from context menus, select the **Printer properties**.  
If **Printer properties** item has ► mark, you can select other printer drivers connected with selected printer.
  - e Click **Port** tab.
  - f Click **Configure Port...** button.
  - g Check if **Printer Name or IP Address**: is the IP address on the network configuration Sheet.
- 3 Change the printer port's IP address if it is different from the network information report's.  
If you want to use the software installation CD to change the port IP,

# Wireless network setup

Connect to a network printer. Then reconnect the IP address.

- For a Static network environment

The machine uses the static address when the computer is configured to static address.

For example,

If the computer's network information is as shown below:

- IP address: 169.254.133.42
- Subnet Mask: 255.255.0.0

Then the machine's network information should be as below:

- IP address: 169.254.133.**43**
- Subnet Mask: 255.255.0.0 (Use the computer's subnet mask.)
- Gateway: 169.254.133.1

## Other problems

If problems occur while using the machine on a network, check the following:



For information on the access point (or wireless router), refer to its own user's guide.

- You cannot enable wired and wireless networks at the same time.
- Your computer, access point (or wireless router), or machine may not be turned on.

- Check the wireless reception around the machine. If the router is far from the machine or there is an obstacle, you might have difficulty receiving the signal.
- Cycle the power for the access point (or wireless router), machine, and computer. Sometimes cycling the power can recover network communication.
- Check whether firewall software (V3 or Norton) is blocking the communication.

If the computer and the machine are connected on the same network and it cannot be found when searching, firewall software might be blocking the communication. Refer to the user's guide for the software to turn it off and try searching for the machine again.

- Check whether the machine's IP address is allocated correctly. You can check the IP address by printing the network configuration report.
- Check whether the access point (or wireless router) has a configured security (password). If it has a password, refer to the access point (or wireless router) administrator.
- Check the machine's IP address. Reinstall the machine driver and change the settings to connect to the machine on the network. Due to the characteristics of DHCP, the allocated IP address could change if the machine is not used for a long time or if the access point has been reset.

Register the product's MAC address when you configure the DHCP server on the access point (or wireless router). Then you can always use the IP address that is set with the MAC address. You can identify the MAC address of your machine by printing a network configuration report (see "Printing a network configuration report" on page 150).

# Wireless network setup

- Check the wireless environment. You might not be able to connect to the network in the infrastructure environment where you need to type in a user's information before connecting to the access point (or wireless router).
- This machine only supports IEEE 802.11 b/g/n and Wi-Fi. Other wireless communication types (e.g., Bluetooth) are not supported.
- When using the ad hoc mode, in operating systems such as Windows Vista, you might need to set the wireless connection setting every time you use the wireless machine.
- You cannot use infrastructure mode and ad hoc mode at the same time for Samsung wireless network machines.
- The machine is within the range of the wireless network.
- The machine is located away from obstacles that could block the wireless signal.

Remove any large metal objects between the access point (or wireless router) and the machine.

Make sure the machine and wireless access point (or wireless router) are not separated by poles, walls, or support columns containing metal or concrete.
- The machine is located away from other electronic devices that may interfere with the wireless signal.

Many devices can interfere with the wireless signal, including a microwave oven and some Bluetooth devices.
- Whenever the configuration of your access point (or wireless router) changes, you must do the devices wireless network setup again.
- The maximum number of device that can be connected via Wi-Fi Direct is 3.
- If Wi-Fi Direct is ON, this machine only supports IEEE 802.11 b/g.
- If the access point is set to work with the 802.11n standard only, it may not connect to your machine.

# Samsung Mobile Print

## What is Samsung Mobile Print?

**Samsung Mobile Print** is a free application that enables users to print photos, documents, and web pages directly from your smartphone or tablet. **Samsung Mobile Print** is not only compatible with your Android and iOS smart phones but also with your iPod Touch and tablet PC. It connects your mobile device to a network connected Samsung printer or to a wireless printer through a Wi-Fi access point. Installing a new driver or configuring network settings isn't necessary – just simply install the **Samsung Mobile Print** application, and it will automatically detect compatible Samsung printers. Besides printing photos, web pages, and PDFs, scanning is also supported. If you have a Samsung multifunction printer, scan any document into a JPG, PDF, or PNG format for quick and easy viewing on your mobile device.

## Downloading Samsung Mobile Print

To download **Samsung Mobile Print**, go to the application store (Samsung Apps, Play Store, App Store) on your mobile device, and just search for "**Samsung Mobile Print**." You can also visit iTunes for Apple devices on your computer.



Android



iOS

## Supported Mobile OS

- Android OS 2.3 or higher
- iOS 4.0 or higher

# Using the NFC feature

The NFC (Near Field Communication) printer allows you to directly print/scan/fax from your mobile device just by holding your mobile device over the NFC tag on your printer. It does not require installing print driver or connecting to an access point. You just need NFC supported mobile device. In order to use this feature, Samsung Mobile Print app needs to be installed on your mobile device.



- Depending on the material of the mobile device cover, NFC recognition may not work properly.
- Depending on the mobile device you are using, the transmission speed may differ.
- This feature is available only for the model with a NFC tag (see "Machine overview" on page 21).
- Using a cover or a battery other than the ones that came with the mobile device, or a metal cover/sticker can block NFC.
- If NFC devices keep failing to communicate, remove and reinstall the battery from the mobile device, then try again.

## Requirements

- NFC and Wi-Fi Direct enabled, Samsung Mobile Print app installed mobile device with Android OS 4.0 or higher.



Only Android OS 4.1 or higher will automatically enable the Wi-Fi Direct feature on your mobile device when you enable the NFC feature. We recommend you to upgrade your mobile device to Android OS 4.1 or higher to use the NFC feature.

- Wi-Fi Direct feature enabled printer (see "Setting up Wi-Fi Direct" on page 191).

# Using the NFC feature

## Printing

- 1 Check that NFC and Wi-Fi Direct features are enabled on your mobile device and Wi-Fi Direct feature is enabled on your printer (see "Setting the Wi-Fi Direct for mobile printing" on page 190).
- 2 Tag the NFC tag on your mobile device (usually located on the back of the mobile device) over the NFC tag (NFC) on your printer.

Wait few seconds for the **Samsung Mobile Print** app to start.

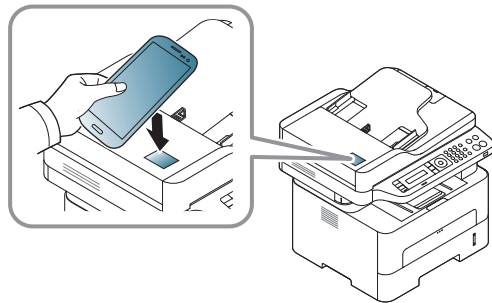

- For some mobile devices, NFC tag might not be located at the back of the mobile device. Check the location of the NFC antenna on your mobile device before tagging.
- If error message about changed PIN number appears, enter a changed PIN number and press **OK**. Follow the instruction on the app screen to update the PIN number.
- If your do not have **Samsung Mobile Print** app installed on your mobile devices, it automatically connects to **Samsung Mobile Print** app download page. Download the app and try again.

- 3 Select print mode.
- 4 Select the content you want to print.

If necessary, change the print option by pressing the .

- 5 Tag the NFC tag on your mobile device (usually located on the back of the mobile device) over the NFC tag (NFC) on your printer.  
Wait few seconds for the mobile device to connect to the printer.

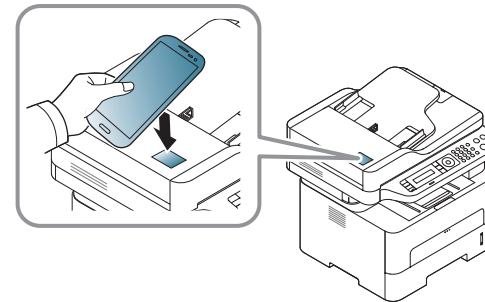

- For some mobile devices, NFC tag might not be located at the back of the mobile device. Check the location of the NFC antenna on your mobile device before tagging.
- If error message about changed PIN number appears, enter a changed PIN number and press **OK**. Follow the instruction on the app screen to update the PIN number.

- 6 The printer starts printing.



# Using the NFC feature

## Scanning

- 1 Check that NFC and Wi-Fi Direct features are enabled on your mobile device and Wi-Fi Direct feature is enabled on your printer (see "Setting the Wi-Fi Direct for mobile printing" on page 190).
- 2 Tag the NFC tag on your mobile device (usually located on the back of the mobile device) over the NFC tag (NFC) on your printer.

Wait few seconds for the **Samsung Mobile Print** app to start.

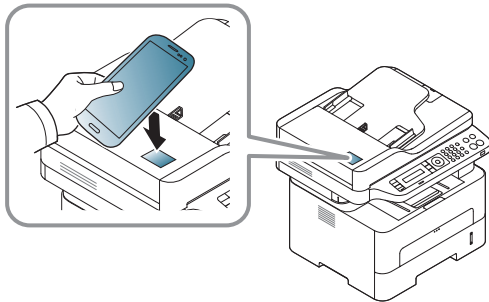

- For some mobile devices, NFC tag might not be located at the back of the mobile device. Check the location of the NFC antenna on your mobile device before tagging.
- If error message about changed PIN number appears, enter a changed PIN number and press **OK**. Follow the instruction on the app screen to update the PIN number.
- If you do not have **Samsung Mobile Print** app installed on your mobile devices, it automatically connects to **Samsung Mobile Print** app download page. Download the app and try again.

- 3 Select scan mode.
- 4 Place a single document face down on the document glass, or load the documents face up into the document feeder (see "Loading in manual feeder" on page 43).

If necessary, change the scan option by pressing the .

- 5 Tag the NFC tag on your mobile device (usually located on the back of the mobile device) over the NFC tag (NFC) on your printer.

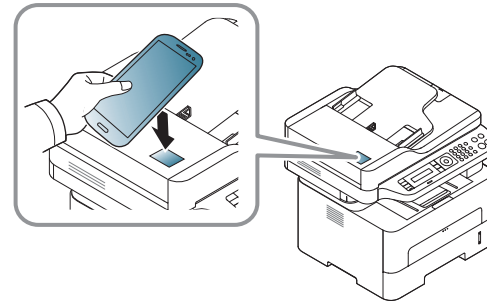

- For some mobile devices, NFC tag might not be located at the back of the mobile device. Check the location of the NFC antenna on your mobile device before tagging.
- If error message about changed PIN number appears, enter a changed PIN number and press **OK**. Follow the instruction on the app screen to update the PIN number.

- 6 The printer starts scanning the content.  
The scanned data is saved on your mobile device.

# Using the NFC feature



If you want to continue scanning, follow the instruction on the app screen.

## Sending Fax

**1** Check that NFC and Wi-Fi Direct features are enabled on your mobile device and Wi-Fi Direct feature is enabled on your printer (see "Setting the Wi-Fi Direct for mobile printing" on page 190).

**2** Tag the NFC tag on your mobile device (usually located on the back of the mobile device) over the NFC tag (NFC) on your printer.

Wait few seconds for the **Samsung Mobile Print** app to start.

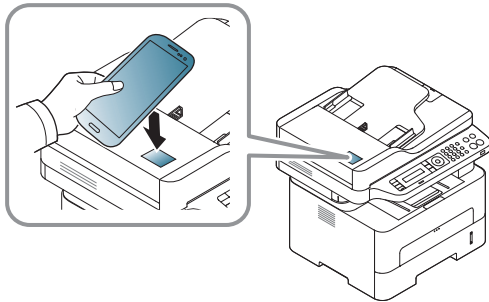

- For some mobile devices, NFC tag might not be located at the back of the mobile device. Check the location of the NFC antenna on your mobile device before tagging.
- If error message about changed PIN number appears, enter a changed PIN number and press **OK**. Follow the instruction on the app screen to update the PIN number.
- If you do not have **Samsung Mobile Print** app installed on your mobile devices, it automatically connects to **Samsung Mobile Print** app download page. Download the app and try again.

**3** Select fax mode.

**4** Select the content you want to send fax.

If necessary, enter the fax number and change the fax option by pressing the .

**5** Tag the NFC tag on your mobile device (usually located on the back of the mobile device) over the NFC tag (NFC) on your printer.

Wait few seconds for the mobile device to connect to the printer.

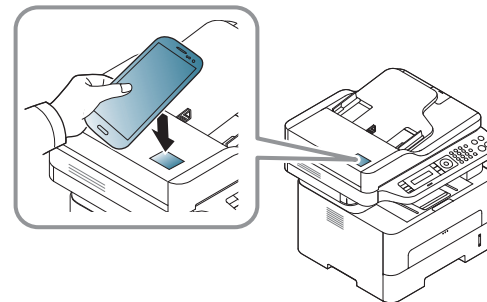

# Using the NFC feature



- For some mobile devices, NFC tag might not be located at the back of the mobile device. Check the location of the NFC antenna on your mobile device before tagging.
- If error message about changed PIN number appears, enter a changed PIN number and press **OK**. Follow the instruction on the app screen to update the PIN number.

6 The printer starts faxing the content.

## Registering Google Cloud Printer

- 1 Check that NFC and Wi-Fi Direct features are enabled on your mobile device and Wi-Fi Direct feature is enabled on your printer.
- 2 Tag the NFC tag on your mobile device (usually located on the back of the mobile device) over the NFC tag (NFC) on your printer.

Wait a few seconds for the **Samsung Mobile Print** app to start.

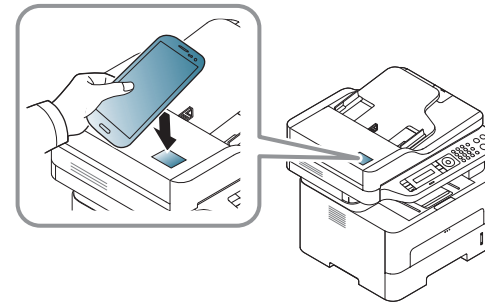

- For some mobile devices, NFC tag might not be located at the back of the mobile device. Check the location of the NFC antenna on your mobile device before tagging.
- If error message about changed PIN number appears, enter a changed PIN number and press **OK**. Follow the instruction on the app screen to update the PIN number.
- If you do not have **Samsung Mobile Print** app installed on your mobile devices, it automatically connects to **Samsung Mobile Print** app download page. Download the app and try again.

# Using the NFC feature

- 3 Select device status icon.
- 4 Select **Google Cloud Print > Register Google Cloud Printer**.
- 5 Tag the NFC tag on your mobile device (usually located on the back of the mobile device) over the NFC tag (NFC) on your printer.

Wait a few seconds for the mobile device to connect to the printer.

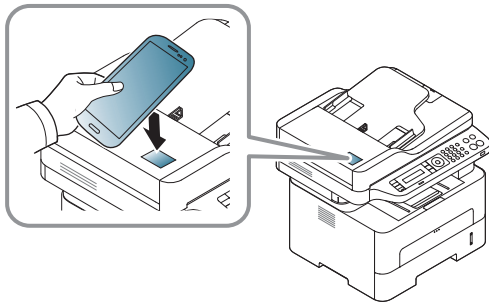

- For some mobile devices, NFC tag might not be located at the back of the mobile device. Check the location of the NFC antenna on your mobile device before tagging.
- If error message about changed PIN number appears, enter a changed PIN number and press **OK**. Follow the instruction on the app screen to update the PIN number.

- 6 Confirm your printer in pop-up window.

Now your printer is registered with Google Cloud Print™ service

# AirPrint



Only AirPrint certified machines can use the AirPrint feature. Check the box your machine came in for the AirPrint certified mark.



AirPrint allows you to wirelessly print directly from an iPhone, iPad, and iPod touch running the latest version of iOS.

## Setting up AirPrint

Bonjour(mDNS) and IPP protocols are required on your machine to use the **AirPrint** feature. You can enable the **AirPrint** feature by one of the following methods.

- 1 Check whether the machine is connected to the network.
- 2 Start a web browser such as Internet Explorer, Safari, or Firefox and enter your machine's new IP address in the browser window.

For example,

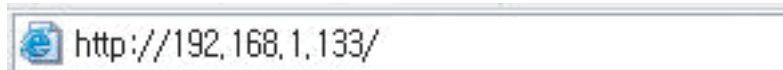

- 3 Click **Login** in the upper right of the SyncThru™ Web Service website.

- 4 Type in the **ID** and **Password**, then click **Login**. If it's your first time logging into SyncThru™ Web Service, type in the below default ID and password. We recommend you to change the default password for security reasons.

- **ID: admin**
- **Password: sec00000**

- 5 When the **SyncThru™ Web Service** window opens, click **Settings > Network Settings**.

- 6 Click **Raw TCP/IP, LPR, IPP** or **mDNS**.

You can enable the IPP protocol or mDNS protocol.

## Printing via AirPrint

For example, the iPad manual provides these instructions:

- 1 Open your email, photo, web page, or document you want to print.
- 2 Touch the action icon()
- 3 Select **your printer driver name** and option menu to set up.
- 4 Touch **Print** button. Print it out.

# AirPrint



**Cancelling print job:** To cancel the printing job or view the print summary, click the print center icon () in multitasking area. You can click cancel in the print center.

# Google Cloud Print™

Google Cloud Print™ is a service that allows you to print to a printer using your smart phone, tablet, or any other web-connected devices. Just register your Google account with the printer, and you are ready to use the Google Cloud Print™ service. You can print your document or email with Chrome OS, Chrome browser, or a Gmail™/ Google Docs™ application on your mobile device, so you don't need to install the printer driver on the mobile device. Refer to the Google website (<http://www.google.com/cloudprint/learn/> or <http://support.google.com/cloudprint>) for more information about Google Cloud Print™.

## Registering your Google account to the printer

### Registering from Samsung Mobile Print app



In order to use this feature, Samsung Mobile Print app needs to be installed on your mobile device.

- 1 Open Samsung Mobile Print app from your mobile device.
- 2 Select device setting.
- 3 Select **Google Cloud Print**.
- 4 Enter your printer's name and description.



If the network environment of your printer is using a proxy server, you need to configure the proxy's IP and port number from **Proxy Setting**. Contact your network service provider or network administrator for more information.

- 5 Click **Register**.
- 6 You need to authenticate as an administrator. Type in the below default ID and password. We recommend you to change the default password for security reasons.
  - **ID: admin**
  - **Password: sec00000**
- 7 Confirm your printer in the pop-up window.  
Now your printer is registered with Google Cloud Print™ service.

### Registering from the Chrome Browser



- Make sure the printer machine is turned on and connected to a wired or wireless network that has access to the Internet.
- You should create your Google account in the advance.

# Google Cloud Print™

- 1 Open the Chrome browser.
- 2 Visit [www.google.com](http://www.google.com).
- 3 Sign in to the Google website with your Gmail™ address.
- 4 Enter your printer's IP address in the address field and press the Enter key or click **Go**.
- 5 Click **Login** in the upper right corner of the SyncThru™ Web Service website.
- 6 If it's your first time logging into **SyncThru™ Web Service** you need to log-in as an administrator. Type in the below default **ID** and **Password**. We recommend you to change the default password for security reasons.
  - **ID: admin**
  - **Password: sec00000**



If the network environment is using a proxy server, you need to configure the proxy's IP and port number from **Settings > Network Settings > Google Cloud Print > Proxy Setting**. Contact your network service provider or network administrator for more information.

- 7 When the **SyncThru™ Web Service** window opens, click **Settings > Network Settings > Google Cloud Print**.
- 8 Enter your printer's name and description.

- 9 Click **Register**.  
The confirmation pop-up window appears.



If you set the browser to block pop-ups, the confirmation window will not appear. Allow the site to show pop-ups.

- 10 Click **Finish printer registration**.
- 11 Click **Manage your printers**.  
Now your printer is registered with Google Cloud Print™ service. Google Cloud Print™-ready devices will appear in the list.



# Google Cloud Print™

## Printing with Google Cloud Print™

The printing procedure varies depending on the application or the device you are using. You can see the application list that supports Google Cloud Print™ service.



Make sure the printer is turned on and connected to a wired or wireless network that has access to the Internet.



## Printing from an application on mobile device

The following steps are an example of using the Google Docs™ app from Android mobile phone.

- 1 Install the Cloud Print application on your mobile device.



If you do not have the application, download it from the application store such as Android Market or App Store.

- 2 Access the Google Docs™ application from your mobile device.
- 3 Tap the option  button of the document that you want to print.
- 4 Tap the send  button.

- 5 Tap the Cloud Print  button.
- 6 Set the printing options if you want.
- 7 Tap **Click here to Print**.

## Printing from the Chrome browser

The following steps are an example of using the Chrome browser.

- 1 Run Chrome.
- 2 Open the document or email that you want to print.
- 3 Click the wrench icon  in the browser's top right corner.
- 4 Click **Print**. A new tab for printing appears.
- 5 Select **Print with Google Cloud Print**.
- 6 Click the **Print** button.



# 3. Useful Setting Menus

This chapter explains how to browse the current status of your machine, and the method of setting for advanced machine setup.

- **Before you begin reading a chapter** 209
- **Print menu** 210
- **Copy menu** 211
- **Fax menu** 214
- **System setup** 217

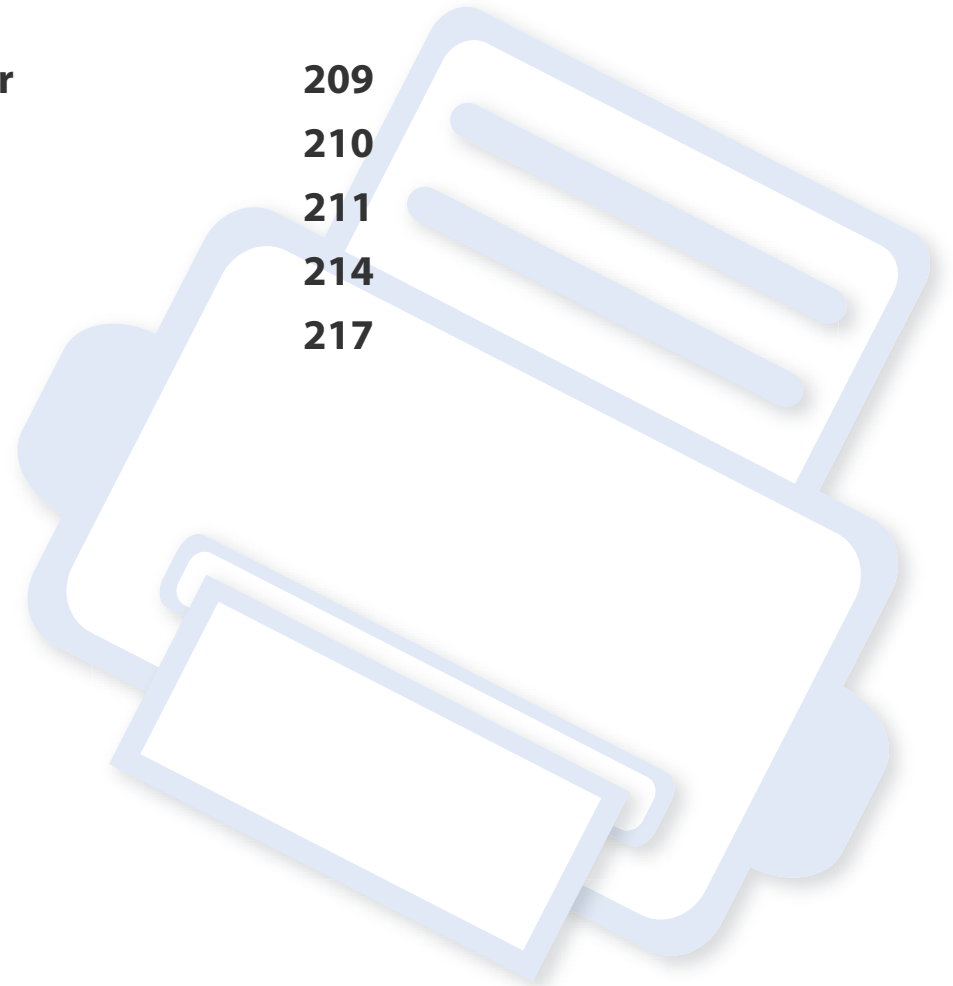



# Before you begin reading a chapter

This chapter explains all the features available for this series' models to help users easily understand the features.

You can check the features available for each model in the Basic Guide (see "Menu overview" on page 33).

The following are tips for using this chapter

- The control panel provides access to various menus to set up the machine or use the machine's functions. These menus can be accessed by pressing  (**Menu**).
- Some menus may not appear on the display depending on options or models. If so, it is not applicable to your machine.
- For models that do not have the  (**Menu**) on the control panel, this feature is not applicable (see "Control panel overview" on page 24).
- Some menu names may differ from your machine depending on its options or the models.



# Print menu



Some menus may not appear in the display depending on options or models. If so, it is not applicable to your machine (see "Menu overview" on page 33).

To change the menu options:

- Press  (**Menu**) > **Print Setup** on the control panel.

Item	Description
<b>Orientation</b>	<p>Selects the direction in which information is printed on a page.</p> <ul style="list-style-type: none"> <li><b>Portrait</b></li> </ul>  <ul style="list-style-type: none"> <li><b>Landscape</b></li> </ul> 

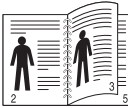
Item	Description
<b>Duplex<sup>a</sup></b>	<p>You can set the machine to print copies on both sides of paper.</p> <ul style="list-style-type: none"> <li><b>Off:</b> Prints in normal mode.</li> <li><b>Short Edge</b></li> </ul>  <ul style="list-style-type: none"> <li><b>Long Edge</b></li> </ul> 
<b>Copies</b>	You can enter the number of copies using the number keypad.
<b>Resolution</b>	Specifies the number of dots printed per inch (dpi). The higher the setting, the sharper printed characters and graphics.
<b>Clear Text</b>	Prints text darker than on a normal document.
<b>Auto CR</b>	Allows you to append the required carriage return to each line feed, which is useful for Unix or DOS users.
<b>SkipBlankPages</b>	The printer detects the printing data from computer whether a page is empty or not. You can set to skip the blank pages.
<b>Emulation</b>	Sets the emulation type and option.

a. M287xND/M287xFD/M287xDW/M287xFW/M287xHN/M288xFW/M288xHW only.



# Copy menu

## Copy feature





Some menus may not appear in the display depending on options or models. If so, it is not applicable to your machine (see "Menu overview" on page 33).

To change the menu options:

- Press  (copy) >  (**Menu**) > **Copy Feature** on the control panel.

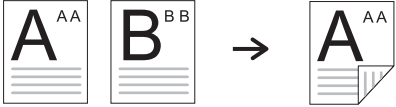
Item	Description
<b>Original Size</b>	Sets the image size.
<b>Reduce/Enlarge</b>	Reduces or enlarges the size of a copied image (see "Reduced or enlarged copy" on page 63).  <div style="border: 1px solid #ccc; padding: 5px; margin-top: 10px;">  If the machine is set to Eco mode, reduce and enlarge features are not available.         </div>

Item	Description
<b>Duplex<sup>a</sup></b>	<p>You can set the machine to print copies on both sides of paper.</p> <ul style="list-style-type: none"> <li><b>1 Sided:</b> Scans one side of an original and prints it on one side of the paper.</li> <li><b>1-&gt;2Sided</b></li> </ul>  <ul style="list-style-type: none"> <li><b>1-&gt;2Sided Rotated</b></li> </ul> 
<b>Darkness</b>	Adjusts the brightness level to make a copy that is easier to read, when the original contains faint markings and dark images (see "Darkness" on page 62)
<b>Original Type</b>	Improves the copy quality by selecting the document type for the current copy job (see "Original" on page 62)

# Copy menu

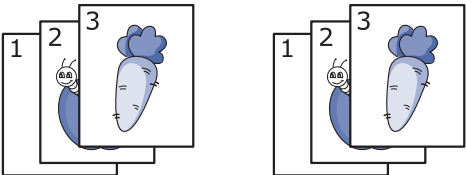
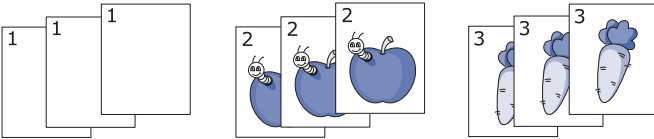
Item	Description
<b>Collation</b>	<p>Set the machine to sort the copy job. For example, if you make 2 copies of a 3 page original, one complete 3 page document will print followed by a second complete document.</p> <ul style="list-style-type: none"> <li>• <b>On:</b> Prints output in sets to match the sequence of originals.</li> </ul>  <ul style="list-style-type: none"> <li>• <b>Off:</b> Prints output sorted into stacks of individual pages.</li> </ul> 
<b>Layout</b>	<p>Adjusts the layout format such as ID copy, 2/4-up, and booklet.</p>

Item	Description
<b>Adjust Bkgd.</b>	<p>Prints an image without its background. This copy feature removes the background color and can be helpful when copying an original containing color in the background, such as a newspaper or a catalog.</p> <ul style="list-style-type: none"> <li>• <b>Off:</b> Does not use this feature.</li> <li>• <b>Auto:</b> Optimizes the background.</li> <li>• <b>Enhance Lev.1~2:</b> The higher the number is, the more vivid the background is.</li> <li>• <b>Erase Lev.1~4:</b> The higher the number is, the lighter the background is.</li> </ul>

a. M287xND/M287xFD/M287xDW/M287xFW/M287xHN/M288xFW/M288xHW only.



# Copy menu

## Copy Setup



Some menus may not appear in the display depending on options or models. If so, it is not applicable to your machine (see "Menu overview" on page 33).

To change the menu options:

Press  (copy) >  (**Menu**) > **Copy Setup** on the control panel.

Item	Description
<b>Change Default</b>	Resets the value or setting to the printer's out-of-box state.



# Fax menu

## Fax Feature





- Some menus may not appear in the display depending on options or models. If so, it is not applicable to your machine (see "Menu overview" on page 33).
- Some features and optional goods may not be available depending on model or country (see "Features by model" on page 7).

To change the menu options:

- Press  (fax) >  **(Menu)** > **Fax Feature** on the control panel.

Item	Description
<b>Darkness</b>	Adjusts the brightness level to scan an original that is easier to read, when the original contains faint markings and dark images (see "Darkness" on page 70).
<b>Resolution</b>	The default document settings produce good results when using typical text-based originals. However, if you send originals that are of poor quality, or contain photographs, you can adjust the resolution to produce a higher quality fax (see "Resolution" on page 69).
<b>Original Size</b>	Sets the image size.

Item	Description
<b>Multi Send</b>	<p>Sends a fax to multiple destinations (see "Sending a fax to multiple destinations" on page 68).</p> <div style="border: 1px solid gray; padding: 5px; margin-top: 10px;">  You cannot send a color fax using this feature.         </div>
<b>Delay Send</b>	<p>Sets your machine to send a fax at a later time when you will not be present (see "Delaying a fax transmission" on page 253).</p> <div style="border: 1px solid gray; padding: 5px; margin-top: 10px;">  You cannot send a color fax using this feature.         </div>
<b>Priority Send</b>	<p>Scans the original into memory and immediately transmits it when the current operation is finished. Priority transmission will interrupt a sending to multiple destinations between stations (example, when the transmission to station A ends, before transmission to station B begins) or between redial attempts (see "Sending a priority fax" on page 255).</p>
<b>Send Forward/ Rcv. Forward</b>	<p>Forwards the received or sent fax to other destination by a fax or PC. If you are out of office but have to receive the fax, this feature may be useful.</p> <ul style="list-style-type: none"> <li>See "Forwarding a sent fax to another destination" on page 255.</li> <li>See "Forwarding a received fax" on page 256.</li> </ul>



# Fax menu

Item	Description
<b>Secure Receive</b>	Stores the received fax in memory without printing out. To print received documents, you need to enter the password. You can prevent your received faxes from being accessed by unauthorized people (see "Receiving in secure receiving mode" on page 259).
<b>Add Page</b>	Adds additional documents to a reserved delay fax job (see "Adding documents to a reserved fax" on page 254).
<b>Cancel Job</b>	Cancels the delayed fax job which is saved in memory (see "Canceling a reserved fax job" on page 254).

## Sending setup



Some menus may not appear in the display depending on options or models. If so, it is not applicable to your machine (see "Menu overview" on page 33).

To change the menu options:

- Press  (fax) >  (**Menu**) > **Fax Setup** > **Sending** on the control panel.

Item	Description
<b>Redial Times</b>	Sets the number of redial attempts. If you enter 0, the machine will not redial.
<b>Redial Term</b>	Sets the time interval before automatic redialling.
<b>Prefix Dial</b>	Sets a prefix of up to five digits. This number dials before any automatic dial number is started. It is useful for accessing a PABX exchange.
<b>ECM Mode</b>	Sends faxes using error correction mode (ECM) to make sure the faxes are sent smoothly without any error. It may take more time.
<b>Modem Speed</b>	Select the maximum modem speed you want if the phone line fails to sustain a higher modem speed.
<b>Fax Confirm.</b>	Sets the machine to print a report whether a fax transmission was successfully completed or not. If you select <b>On-Error</b> , the machine prints a report only when a transmission is not successful.
<b>Image TCR</b>	Prints a transmission report with a minimized image of the first page of the fax sent.
<b>Dial Mode</b>	Sets the dialing mode to either tone or pulse. This setting may not be available depending on your country.

# Fax menu

## Receiving setup



Some menus may not appear in the display depending on options or models. If so, it is not applicable to your machine (see "Menu overview" on page 33).

To change the menu options:

- Press (fax) > (Menu) > **Fax Setup** > **Receiving** on the control panel.

Item	Description
<b>Receive Mode</b>	Selects the default fax receiving mode.
<b>Ring to Answer</b>	Specifies the number of times the machine rings before answering an incoming call.
<b>Stamp Rcv Name</b>	Automatically prints the page number, and the date and time of reception at the bottom of each page of a received fax.
<b>Rcv Start Code</b>	Initiates fax reception from an extension phone plugged into the EXT socket on the back of the machine. If you pick up the extension phone and hear fax tones, enter the code. It is preset to *9* at the factory.

Item	Description
<b>Auto Reduction</b>	Automatically reduces an incoming fax page to fit the size of the paper loaded in the machine.
<b>Discard Size</b>	Discards a specific length from the end of the received fax.
<b>Junk Fax Setup</b>	Blocks any unwanted faxes that you stored in the memory as junk fax numbers. This setting may not be available depending on your country.
<b>DRPD Mode</b>	Enables a user to use a single telephone line to answer several different telephone numbers. You can set the machine to recognize different ring patterns for each number. This setting may not be available depending on your country (see "Receiving faxes using DRPD mode" on page 258).
<b>Duplex Print<sup>a</sup></b>	Prints the received fax data on both sides of the paper. You can save the paper usage.
<b>Change Default</b>	Resets the value or setting to the printer's out-of-box state.
<b>Manual TX/RX</b>	Setting this option to <b>ON</b> provides the ability to send or receive a fax while the line is busy. You can select to send or receive a fax by either picking up the extension phone receiver and pressing the <b>Start</b> button or by pressing the  ( <b>On Hook Dial</b> ) button and pressing the Start button.

a. M287xFD/M287xFW/M287xHN/M288xFW/M288xHW only.

# System setup

## Machine setup



Some menus may not appear in the display depending on options or models. If so, it is not applicable to your machine (see "Menu overview" on page 33).

To change the menu options:

- Press (Menu) > **System Setup** > **Machine Setup** on the control panel.

Item	Description
<b>Machine ID</b>	Sets the machine ID which will be printed at the top of each fax page that you send.
<b>Fax Number</b>	Sets the fax number which will be printed at the top of each fax page that you send.
<b>Date &amp; Time</b>	Sets the date and time.
<b>Clock Mode</b>	Selects the format for displaying time between 12 hr. and 24 hr.
<b>Language</b>	Sets the language of the text that appears on the control panel display.
<b>Default Mode</b>	Sets the machine's default mode among fax mode and copy mode.

Item	Description
<b>PowerSave</b>	<p>Sets how long the machine waits before going to power save mode.</p> <p>When the machine does not receive data for an extended period of time, power consumption is automatically lowered.</p>
<b>Auto Power Off</b>	<p>Turns power off automatically when the machine has been in power save mode for the length of time set in <b>Auto Power Off &gt; On &gt; Timeout</b>.</p> <div data-bbox="1473 705 1534 769"></div> <ul style="list-style-type: none"><li>This option only appears in the M267xN/ M287xND.</li><li>To turn the machine on again, press the  (<b>Power/Wake Up</b>) button on the control panel (make sure the main power switch is on).</li><li>If you run the printer driver or Samsung Easy Printer Manager, the time automatically extends.</li><li>While the machine is connected to the network or working on a print job, <b>Auto Power Off</b> feature doesn't work.</li></ul>

# System setup

Item	Description
<b>Wakeup Event</b>	<p>You can set the condition to wake up from power-save mode.</p> <ul style="list-style-type: none"><li>• <b>On:</b> The machine wake up from the power save mode on the following cases:<ul style="list-style-type: none"><li>- Pressing any button</li><li>- Opening or closing the paper tray</li><li>- Inserting paper in the document feeder</li></ul></li><li>• <b>Off:</b> The machine wake up from the power save mode only when the  (<b>Power/Wake Up</b>) button is pressed.</li></ul>
<b>System Timeout</b>	<p>Sets the time that the machine remembers previously used copy settings. After the timeout, the machine restores the default copy settings.</p>
<b>Job Timeout</b>	<p>Sets the length of time the printer waits before printing the last page of a print job that does not end with a command to print the page.</p>
<b>Altitude Adj.</b>	<p>Optimize print quality according to the machine's altitude.</p>

Item	Description
<b>Auto Continue</b>	<p>Determine whether or not the machine continues printing when it detects the paper does not match the paper settings.</p> <ul style="list-style-type: none"><li>• <b>0 Sec:</b> This option allows you to continue printing when the paper size you have set is mismatched with the paper in the tray.</li><li>• <b>30 Sec:</b> If a paper mismatch occurs, an error message will display. The machine waits for about 30 second, then automatically clear the message and continue printing.</li><li>• <b>Off:</b> If a paper mismatch occurs, the machine waits until you insert the correct paper.</li></ul>
<b>Paper Substit.</b>	<p>Automatically substitutes the printer driver's paper size to prevent the paper mismatch between Letter and A4. For example, if you have A4 paper in the tray but you set the paper size to Letter in the printer driver, the machine prints on A4 paper and vice versa.</p>
<b>Toner Save</b>	<p>Activating this mode extends the life of your toner cartridge and reduces your cost per page beyond what one would experience in the normal mode, but it reduces print quality.</p>

# System setup

Item	Description
<b>Eco Settings</b>	<p>Allows you to save print resources and enables eco-friendly printing.</p> <ul style="list-style-type: none"><li>• <b>Default Mode:</b> Select whether to turn the Eco mode on or off.</li></ul> <p> <b>On force (On-Forced):</b> Sets the Eco mode on with password. If a user wants to turn the Eco mode on/off, the user needs to enter the password.</p> <ul style="list-style-type: none"><li>• <b>Select Temp.:</b> Selects the eco template set from the SyncThru™ Web Service.</li></ul>

## Paper setup



Some menus may not appear in the display depending on options or models. If so, it is not applicable to your machine (see "Menu overview" on page 33).

To change the menu options:

- Press  (**Menu**) > **System Setup** > **Paper Setup** on the control panel.

Item	Description
<b>Paper Size</b>	Sets the paper size as A4, Letter, or other paper sizes, according to your requirements.
<b>Paper Type</b>	Chooses the type of the paper for each tray.
<b>Paper Source</b>	Selects from which tray the paper is used.
<b>Margin</b>	Sets the margins for the document.

# System setup

## Sound / Volume



Some menus may not appear in the display depending on options or models. If so, it is not applicable to your machine (see "Menu overview" on page 33).

To change the menu options:

- Press (**Menu**) > **System Setup** > **Sound/Volume** on the control panel.

Item	Description
<b>Key Sound</b>	Turns the key sound on or off. With this option set to on, a tone sounds each time a key is pressed.
<b>Alarm Sound</b>	Turns the alarm sound on or off. With this option set to on, an alarm tone sounds when an error occurs or fax communication ends.

Item	Description
<b>Speaker</b>	<p>Turns on or off the sounds from the telephone line through the speaker, such as a dial tone or a fax tone. With this option set to <b>Comm.</b> which means the speaker is on until the remote machine answers.</p> <p> You can adjust the volume level using  (<b>On Hook Dial</b>). You can adjust the speaker volume only when the telephone line is connected.</p> <ol style="list-style-type: none"><li>Press  (fax) on the control panel.</li><li>Press  (<b>On Hook Dial</b>). A dial tone sounds from the speaker.</li><li>Press the arrows until you hear the volume you want.</li><li>Press  (<b>On Hook Dial</b>) to save the change and return to ready mode.</li></ol>
<b>Ringer</b>	Adjusts the ringer volume. For the ringer volume, you can select off, low, middle, and high level.

# System setup

## Report



Some menus may not appear in the display depending on options or models. If so, it is not applicable to your machine (see "Menu overview" on page 33).

To change the menu options:

- Press  (**Menu**) > **System Setup** > **Report** on the control panel.

Item	Description
<b>Configuration</b>	Prints a report on the machine's overall configuration.
<b>Demo Page</b>	Prints the demo page to check whether your machine is printing properly or not.
<b>Network Conf.</b>	Prints information on your machine's network connection and configuration.
<b>Supplies Info.</b>	Prints supplies' information page.
<b>Usage Counter</b>	Prints a usage page. The usage page contains the total number of pages printed.
<b>Fax Received</b>	Prints information on the faxes you have recently received.

Item	Description
<b>Fax Sent</b>	Prints information on the faxes you have recently sent.
<b>Scheduled Jobs</b>	Prints the document list currently stored for delayed faxes along with the starting time and type of each operation.
<b>Fax Confirm.</b>	Sets the machine to print a report whether a fax transmission was successfully completed or not.
<b>JunkFax</b>	Prints the fax numbers specified as junk fax numbers.
<b>PCL Font List</b>	Prints the PCL font list.
<b>Address Book</b>	Prints all of the email addresses currently stored in the machine's memory.

## Maintenance



Some menus may not appear in the display depending on options or models. If so, it is not applicable to your machine (see "Menu overview" on page 33).

# System setup

To change the menu options:

- Press  (**Menu**) > **System Setup** > **Maintenance** on the control panel.

Item	Description
<b>CLR Empty Msg.</b>	When toner cartridge is empty, this option appears. You can clear the empty message.
<b>Supplies Life</b>	Shows the supply life indicators (see "Monitoring the supplies life" on page 84.)
<b>Image Mgr.</b>	Allows you to adjust the image setting such as density. <ul style="list-style-type: none"><li>• <b>Custom Color:</b> adjusts contrast.<ul style="list-style-type: none"><li>- <b>Default:</b> optimizes density automatically.</li><li>- <b>Print Density:</b> allows you to manually adjust the contrast. It is recommended to use the Default setting for best quality.</li></ul></li></ul>
<b>TonerLow Alert</b>	Customizes the level to alert toner low or toner empty (see "Setting the toner low alert" on page 85).
<b>ImgU.Low Alert</b>	Allows you to set the alarm for when the imaging unit is low.  M2675/M2676/M2875/M2876 series only.
<b>Serial Number</b>	Shows the machine's serial number. When you call for service or register as a user on the Samsung website, you can find this.

## Network setup



Some menus may not appear in the display depending on options or models. If so, it is not applicable to your machine (see "Menu overview" on page 33).

- Press  (**Menu**) > **Network** on the control panel,

Option	Description
<b>TCP/IP (IPv4)</b>	Selects the appropriate protocol and configure parameters to use the network environment.  There are lots of parameters to be set. If you are not sure, leave as is, or consult the network administrator.
<b>TCP/IP (IPv6)</b>	Selects this option to use the network environment through IPv6 (see "IPv6 configuration" on page 162).
<b>Ethernet Speed</b>	Configure the network transmission speed.
<b>Wireless</b>	Selects this option to use the wireless network.



# System setup

Option	Description
<b>Protocol Mgr.</b>	<p>You can activate or deactivate the following protocols.</p> <ul style="list-style-type: none"> <li>• <b>Net. Activate:</b> You can set whether to use Ethernet on or off.</li> <li>• <b>Http Activate:</b> You can sets whether to use SyncThru™ Web Service or not.</li> <li>• <b>WINS:</b> You can configure the WINS server. WINS(Windows Internet Name Service) is used in the Windows operating system.</li> <li>• <b>SNMP V1/V2:</b> You have to enable this option to use SNMP V1/V2 protocol. Administrator's can use SNMP to monitor and manage machines on the network.</li> <li>• <b>UPnP(SSDP):</b> You have to enable this option to use UPnP(SSDP) protocol.</li> </ul> <div style="border: 1px solid #ccc; padding: 5px; margin-top: 10px;">  Turn the power off and on after you change above options.         </div>

Option	Description
<b>Protocol Mgr. (continued.)</b>	<ul style="list-style-type: none"> <li>• <b>MDNS:</b> You have to enable this option to use MDNS (Multicast Domain Name System) protocol.</li> <li>• <b>SetIP:</b> You have to enable this option to use SetIP protocol.</li> <li>• <b>SLP:</b> You can configure SLP (Service Location Protocol) settings. This protocol allows host applications to find services in a local area network without prior configuration.</li> </ul> <div style="border: 1px solid #ccc; padding: 5px; margin-top: 10px;">  Turn the power off and on after you change this option.         </div>
<b>Network Conf.</b>	This list shows information on your machine's network connection and configuration.
<b>Clear Setting</b>	Reverts the network settings to the default values. (Reboot required.)



# 4. Special Features

This chapter explains special copying, scanning, faxing, and printing features.

- **Altitude adjustment** 225
- **Entering various characters** 226
- **Setting up the fax address book** 228
- **Printing features** 231
- **Scan features** 245
- **Fax features** 252



- The procedures in this chapter are mainly based on Windows 7.
- It may be necessary to press **OK** to navigate to lower-level menus for some models.

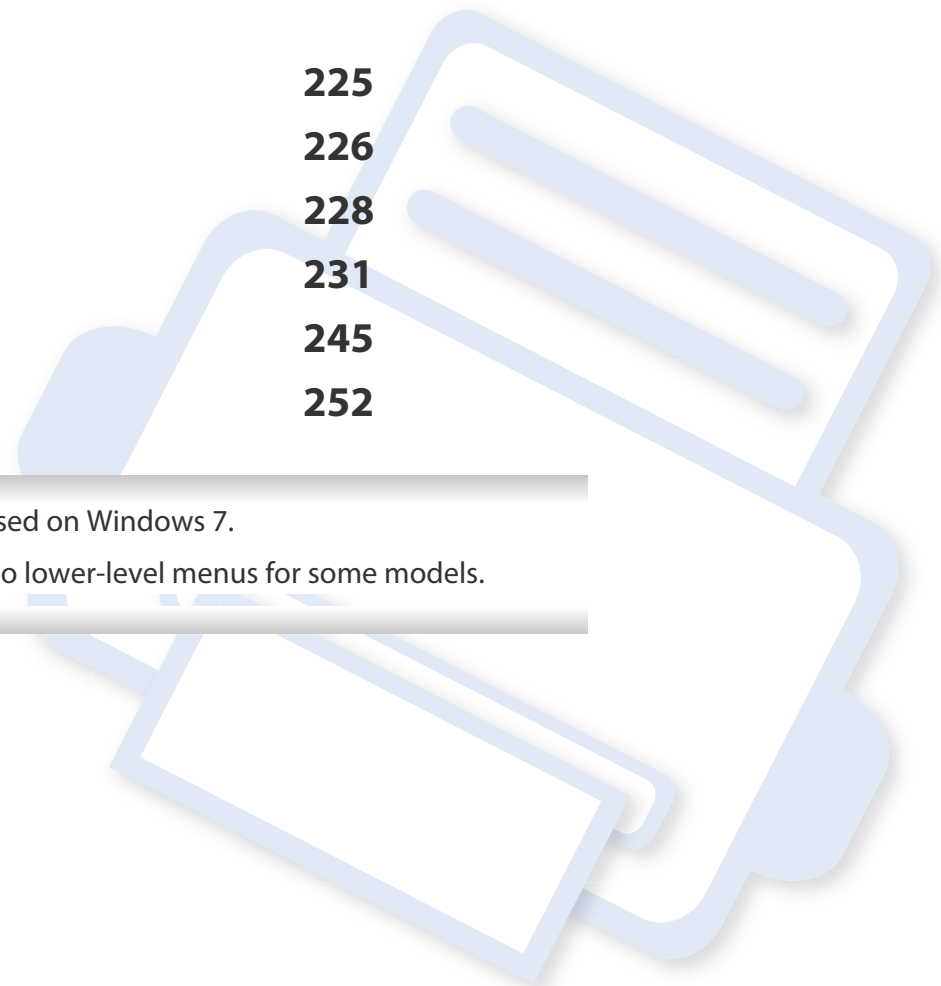

# Altitude adjustment

Print quality is affected by atmospheric pressure, which is determined by the height of the machine above sea level. The following information will guide you on how to set your machine for the best print quality.

Before you set the altitude value, determine the altitude where you are.

- Normal: 0-1,000 m(3,280 ft)
- High1: 1,000 m(3,280 ft)-2,000 m(6,561 ft)
- High2: 2,000 m(6,561 ft)-3,000 m(9,842 ft)
- High3: 3,000 m(9,842 ft)-4,000 m(13,123 ft)
- High4: 4,000 m(13,123 ft)-5,000 m(16,404 ft)

You can set the altitude value from **Device Settings** in Samsung Easy Printer Manager program or **Machine** section in Printer Settings Utility program.

- For Windows and Mac users, you set from **Samsung Easy Printer Manager** >  **(Switch to advanced mode)** > **Device Settings**, see "Device Settings" on page 272.



- If your machine is connected to the network, you can set the altitude via SyncThru™ Web Service (see "Using SyncThru™ Web Service" on page 266).
- You can also set the altitude in **System Setup** option on the machine's display (see "Menu overview" on page 33).

# Entering various characters

As you perform various tasks, you may need to enter names and numbers. For example, when you set up your machine, you enter your name or your company's name, and the fax number. When you store fax numbers or email addresses in memory, you may also enter the corresponding names.

## Entering alphanumeric characters

Press the button until the correct letter appears on the display. For example, to enter the letter O, press 6, labeled with MNO. Each time you press 6, the display shows a different letter, M, N, O, m, n, o and finally 6. To find the letter that you want to enter, see "Keypad letters and numbers" on page 226.



- You can enter a space by pressing 1 twice.
- To delete the last digit or character, press the left/right or up/down arrow button.

## Keypad letters and numbers



- Special character sets may differ from your machine depending on its options or the models.
- Some of the follow key values may not appear depending on the job you are doing.



Key	Assigned numbers, letters, or characters
1	@ / . \' 1
2	ABC a b c 2
3	DEF d e f 3
4	GHI g h i 4
5	JKL j k l 5



# Entering various characters



Key	Assigned numbers, letters, or characters
6	MNOmno6
7	PQRSpqrs7
8	TUVtuv8
9	WXYZwxyz9
0	&+ -,0
*	*
	(These symbols are available when you type for network authentication.)
#	#
	(These symbols are available when you type for network authentication.)

# Setting up the fax address book

You can set up speed number with the fax numbers you use frequently via SyncThru™ Web Service and then easily and quickly enter fax numbers by entering the location numbers assigned to them in address book.

## Registering a speed dial number

- 1 Select  (fax) >  (**Address Book**) > **New & Edit** > **Speed Dial** on the control panel.
- 2 Enter a speed dial number and press **OK**.



 If an entry is already stored in the number you choose, the display shows the message to allow you to change it. To start over with another speed dial number, press  (**Back**).

- 3 Enter the name you want and press **OK**.
- 4 Enter the fax number you want and press **OK**.
- 5 Press the  (**Stop/Clear**) button to return to ready mode.



## Using speed dial numbers

When you are prompted to enter a destination number while sending a fax, enter the speed dial number at which you stored the number you want.



- For a one-digit (0-9) speed dial number, press and hold the corresponding digit button on the number keypad for more than 2 seconds.
- For a two- or three-digit speed dial number, press the first digit button(s) and then hold down the last digit button for more than 2 seconds.
- You can print the address book list by selecting  (fax) >  (**Address Book**) > **Print**.

## Editing speed dial numbers

- 1 Select  (fax) >  (**Address Book**) > **New & Edit** > **Speed Dial** on the control panel.
- 2 Enter the speed dial number you want to edit and press **OK**.
- 3 Change the name and press **OK**.
- 4 Change the fax number and press **OK**.



# Setting up the fax address book

- 5 Press  (**Stop/Clear**) to return to ready mode.

## Registering a group dial number



- 1 Select  (fax) >  (**Address Book**) > **New & Edit** > **Group Dial** on the control panel.

- 2 Enter a group dial number and press **OK**.

 If an entry is already stored in the number you choose, the display shows the message to allow you to change it. To start over with another speed dial number, press  (**Back**).

- 3 Search by entering the first few letters of the speed dial's name to put in the group.
- 4 Select the name and number you want and press **OK**.
- 5 Select **Yes** when **Another Number?** appears.
- 6 Repeat step 3 to include other speed dial numbers into the group.
- 7 When you have finished, select **No** when **Another Number?** appears and press **OK**.
- 8 Press  (**Stop/Clear**) to return to ready mode.



## Editing group dial numbers

- 1 Select  (fax) >  (**Address Book**) > **New & Edit** > **Group Dial** on the control panel.
- 2 Enter the group dial number you want to edit and press **OK**.
- 3 Enter a new speed dial number to add and press **OK**, then **Add?** appears. Enter a speed dial number stored in the group and press **OK**, **Delete?** appears.
- 4 Press **OK** to add or delete the number.
- 5 Repeat step 3 to add or delete more numbers.
- 6 Select **No** at the **Another Number?** and press **OK**.
- 7 Press  (**Stop/Clear**) to return to ready mode.

# Setting up the fax address book



## Searching address book for an entry

There are two ways to search for a number in memory. You can either scan from A to Z sequentially, or you can search by entering the first letters of the name associated with the number.

- 1 Select  (fax) >  (**Address Book**) > **Search & Dial** > **Speed Dial** or **Group Dial** on the control panel.
- 2 Enter **All** or **ID** and press **OK**.
- 3 Press the name and number or the keypad button labeled with the letter you want to search.  
  
For example, if you want to find the name "MOBILE," press the **6** button, which is labeled with "MNO."
- 4 Press  (**Stop/Clear**) to return to ready mode.

## Printing address book

You can check your  (**Address Book**) settings by printing a list.

- 1 Select  (fax) >  (**Address Book**) > **Print** on the control panel.
- 2 The machine begins printing.



# Printing features



- For basic printing features, refer to the Basic Guide (see "Basic printing" on page 55).
- This feature may not be available depending on model or optional goods (see "Features by model" on page 7).

## Changing the default print settings

- 1 Click the Windows **Start** menu.
  - For Windows 8, from the **Charms**, select **Search > Settings**.
- 2 For Windows XP/Server 2003, select **Printer and Faxes**.
  - For Windows Server 2008/Vista, select **Control Panel > Hardware and Sound > Printers**.
  - For Windows Server 2008 R2, select **Control Panel > Hardware > Devices and Printers**.
  - For Windows 7/8, select **Control Panel > Devices and Printers**.
- 3 Right-click on your machine.
- 4 For Windows XP/Server 2003/Server 2008/Vista, select **Printing Preferences**.  
For Windows 7/8 or Windows Server 2008 R2, from context menus, select **Printing preferences**.



If **Printing preferences** has a ►, you can select other printer drivers connected to the selected printer.

- 5 Change the settings on each tab.
- 6 Click **OK**.



If you want to change the settings for each print job, change it in **Printing Preferences**.

## Setting your machine as a default machine

- 1 Click the Windows **Start** menu.
  - For Windows 8, from the **Charms**, select **Search > Settings**.
- 2 For Windows XP/Server 2003, select **Printer and Faxes**.
  - For Windows Server 2008/Vista, select **Control Panel > Hardware and Sound > Printers**.
  - For Windows Server 2008 R2, select **Control Panel > Hardware > Devices and Printers**.
  - For Windows 7/8, select **Control Panel > Devices and Printers**.

# Printing features

- 3 Select your machine.
- 4 Right-click your machine and select **Set as Default Printer**.

 For Windows 7 or Windows Server 2008 R2, if **Set as default printer** has a ►, you can select other printer drivers connected to the selected printer.

## Using advanced print features

-  **XPS printer driver:** used to print XPS file format.
- See "Features by model" on page 7.
  - The XPS printer driver can be installed only on Windows Vista OS or higher.
  - For models that provide XPS driver from the Samsung website, <http://www.samsung.com> > find your product > Support or downloads.

## Printing to a file (PRN)

You will sometimes need to save the print data as a file.

- 1 Check the **Print to file** box in the **Print** window.

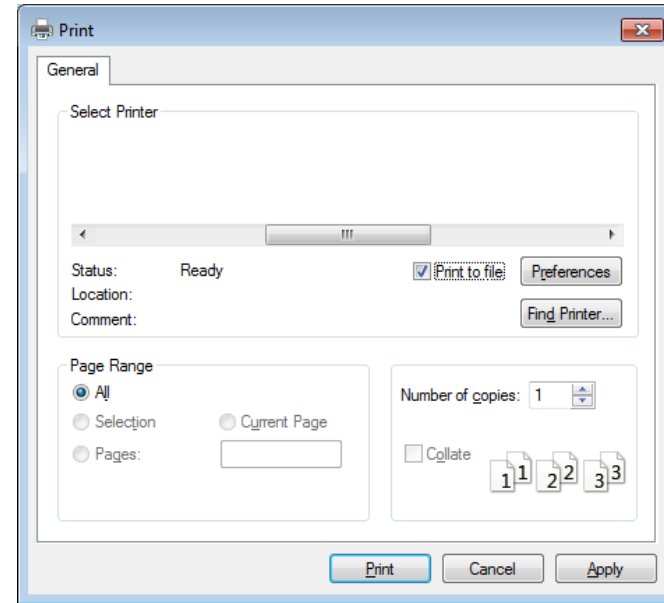

- 2 Click **Print**.
- 3 Type in the destination path and the file name, and then click **OK**.  
For example, **c:\Temp\file name**.

 If you type in only the file name, the file is automatically saved in **My Documents**, **Documents and Settings**, or **Users**. The saved folder may differ, depending on your operating system or the application you are using.

# Printing features

## Understanding special printer features

You can use advanced printing features when using your machine.



To take advantage of the printer features provided by your printer driver, click **Properties** or **Preferences** in the application's **Print** window to change the print settings. The machine name, that appears in the printer properties window may differ depending on the machine in use.



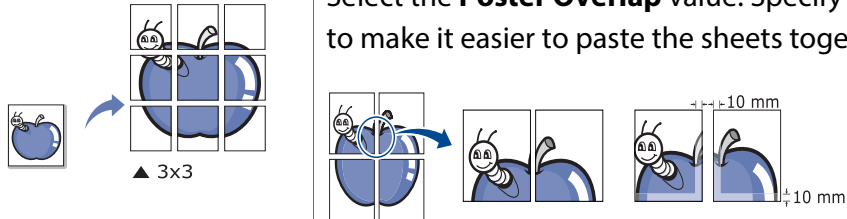

- Some menus may not appear on the display depending on options or models. If so, it is not applicable to your machine.
- Select the **Help** menu or click the  button from the window or press **F1** on your keyboard and click on any option you want to know about (see "Using help" on page 58).

Item	Description
<p data-bbox="51 799 315 869"><b>Multiple Pages per Side</b></p> 	<p data-bbox="383 799 2175 869">Selects the number of pages to print on a single sheet of paper. To print more than one page per sheet, the pages will be reduced in size and arranged in the order you specify. You can print up to 16 pages on one sheet.</p>
<p data-bbox="51 1153 259 1185"><b>Poster Printing</b></p> 	<p data-bbox="383 1112 2130 1185">Prints a single-page document onto 4 (Poster 2x2), 9 (Poster 3x3), or 16 (Poster 4x4) sheets of paper, for the purpose of pasting the sheets together to form one poster-size document.</p> <p data-bbox="383 1208 2190 1281">Select the <b>Poster Overlap</b> value. Specify <b>Poster Overlap</b> in millimeters or inches by selecting the radio button on the upper right of <b>Basic</b> tab to make it easier to paste the sheets together.</p>

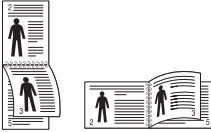
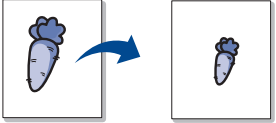

# Printing features

Item	Description
<p><b>Booklet Printing<sup>ab</sup></b></p> 	<p>Prints your document on both sides of a sheet of paper and arranges the pages so that the paper can be folded in half after printing to produce a booklet.</p> <ul style="list-style-type: none"><li>• If you want to make a booklet, you need to print on Letter, Legal, A4, US Folio, or Oficio sized print media.</li><li>• The <b>Booklet Printing</b> option is not available for all paper sizes. Select the available paper <b>Size</b> option under the <b>Paper</b> tab to see what paper sizes are available.</li><li>• If you select an unavailable paper size, this option can be automatically canceled. Select only available paper (paper without  or  mark).</li></ul>
<ul style="list-style-type: none"><li>• <b>Double-sided Printing<sup>b</sup></b></li><li>• <b>Double-sided Printing (Manual)<sup>a</sup></b></li></ul>	<p>Print on both sides of a sheet of paper (duplex). Before printing, decide how you want your document oriented.</p> <ul style="list-style-type: none"><li>• You can use this feature with Letter, Legal, A4, US Folio or Oficio sized paper</li><li>• If your machine does not have a duplex unit, you should complete the printing job manually. The machine prints every other page of the document first. After that, a message appears on your computer.</li><li>• <b>Skip Blank Pages</b> feature does not work when you select the duplex option.</li></ul>

# Printing features

Item	Description
<ul style="list-style-type: none"><li>• <b>Double-sided Printing<sup>b</sup></b></li><li>• <b>Double-sided Printing (Manual)<sup>a</sup></b></li></ul>	<ul style="list-style-type: none"><li>• <b>Off:</b> Disables this feature.</li><li>• <b>Long Edge:</b> This option is the conventional layout used in bookbinding. The diagram shows two pages of a document. The top page is labeled '2' and the bottom page is labeled '3'. The pages are oriented vertically, with the binding edge on the left side.</li><li>• <b>Short Edge:</b> This option is the conventional layout used in calendars. The diagram shows two pages of a document. The top page is labeled '2' and the bottom page is labeled '3'. The pages are oriented horizontally, with the binding edge on the top side.</li></ul>
<b>Paper Options</b>  The diagram shows two boxes, each containing a carrot. A blue arrow points from the larger carrot in the left box to the smaller carrot in the right box, indicating a size reduction.	Changes the size of a document to appear larger or smaller on the printed page by entering in a percentage by which to enlarge or decrease the document.
<b>Watermark</b>  The diagram shows two document pages. The left page is a standard document. The right page has the word 'CONFIDENTIAL' printed diagonally across it in a light gray font.	The watermark option allows you to print text over an existing document. For example, you use it when you want to have large gray letters reading “ <b>DRAFT</b> ” or “ <b>CONFIDENTIAL</b> ” printed diagonally across the first page or all pages of a document.
<b>Watermark (Creating a watermark)</b>	<ul style="list-style-type: none"><li><b>a</b> To change the print settings from your software application, access <b>Printing Preferences</b>.</li><li><b>b</b> Click the <b>Advanced</b> tab, select <b>Edit</b> from the <b>Watermark</b> drop-down list. The <b>Edit Watermarks</b> window appears.</li><li><b>c</b> Enter a text message in the <b>Watermark Message</b> box. You can enter up to 256 characters. The message displays in the preview window.</li></ul>

# Printing features

Item	Description
<b>Watermark</b> (Editing a watermark)	<p><b>a</b> To change the print settings from your software application, access <b>Printing Preferences</b>.</p> <p><b>b</b> Click the <b>Advanced</b> tab, select <b>Edit</b> from the <b>Watermark</b> drop-down list. The <b>Edit Watermarks</b> window appears.</p> <p><b>c</b> Select the watermark you want to edit from the <b>Current Watermarks</b> list and change the watermark message and options.</p> <p><b>d</b> Click <b>Update</b> to save the changes.</p> <p><b>e</b> Click <b>OK</b> or <b>Print</b> until you exit the <b>Print</b> window.</p>
<b>Watermark</b> (Deleting a watermark)	<p><b>a</b> To change the print settings from your software application, access <b>Printing Preferences</b>.</p> <p><b>b</b> Click the <b>Advanced</b> tab, select <b>Edit</b> from the <b>Watermark</b> drop-down list. The <b>Edit Watermarks</b> window appears.</p> <p><b>c</b> Select the watermark you want to delete from the <b>Current Watermarks</b> list and click <b>Delete</b>.</p> <p><b>d</b> Click <b>OK</b> or <b>Print</b> until you exit the <b>Print</b> window.</p>
<b>Overlay<sup>a</sup></b>	<p>This option is available only when you use the PCL/SPL printer driver (see "Software" on page 7).</p> <p>An overlay is text and/or images stored in the computer hard disk drive (HDD) as a special file format that can be printed on any document. Overlays are often used to take the place of letterhead paper. Rather than using preprinted letterhead, you can create an overlay containing exactly the same information that is currently on your letterhead. To print a letter with your company's letterhead, you do not need to load preprinted letterhead paper in the machine: just print the letterhead overlay on your document.</p> <p>To use a page overlay, you must create a new page overlay containing your logo or image.</p> <div data-bbox="56 879 349 1034"></div> <div data-bbox="383 999 2197 1158" style="background-color: #f0f0f0; padding: 10px;"><ul style="list-style-type: none"><li> The overlay document size must be the same as the document you print with the overlay. Do not create an overlay with a watermark.</li><li>The resolution of the overlay document must be the same as that of the document you will print with the overlay.</li></ul></div>

# Printing features

Item	Description
<b>Overlay<sup>a</sup></b> <b>(Creating a new page overlay)</b>	<p><b>a</b> To save the document as an overlay, access <b>Printing Preferences</b>.</p> <p><b>b</b> Click the <b>Advanced</b> tab, and select <b>Edit</b> from the <b>Text</b> drop-down list. <b>Edit Overlay</b> window appears.</p> <p><b>c</b> In the <b>Edit Overlay</b> window, click <b>Create</b>.</p> <p><b>d</b> In the <b>Save As</b> window, type a name up to eight characters in the <b>File name</b> box. Select the destination path, if necessary (The default is C:\FormOver).</p> <p><b>e</b> Click <b>Save</b>. The name appears on the <b>Overlay List</b>.</p> <p><b>f</b> Click <b>OK</b> or <b>Print</b> until you exit the <b>Print</b> window. The file is not printed. Instead, it is stored on your computer hard disk drive.</p>
<b>Overlay<sup>a</sup></b> <b>(Using a page overlay)</b>	<p><b>a</b> Click the <b>Advanced</b> tab.</p> <p><b>b</b> Select the desired overlay from the <b>Text</b> drop-down list.</p> <p><b>c</b> If the overlay file you want does not appear in the <b>Text</b> drop-down list, select <b>Edit...</b> from the list and click <b>Load</b>. Select the overlay file you want to use. If you have stored the overlay file you want to use in an external source, you can also load the file when you access the <b>Open</b> window. After you select the file, click <b>Open</b>. The file appears in the <b>Overlay List</b> box and is available for printing. Select the overlay from the <b>Overlay List</b> box.</p> <p><b>d</b> If necessary, check <b>Confirm Page Overlay When Printing</b> box. If this box is checked, a message window appears each time you submit a document for printing, asking you to confirm printing an overlay on your document. If this box is not checked and an overlay has been selected, the overlay automatically prints with your document.</p> <p><b>e</b> Click <b>OK</b> or <b>Print</b> until you exit the <b>Print</b> window.</p>
<b>Overlay<sup>a</sup></b> <b>(Deleting a page overlay)</b>	<p><b>a</b> In the <b>Printing Preferences</b> window, click the <b>Advanced</b> tab.</p> <p><b>b</b> Select <b>Edit</b> in the <b>Text</b> drop down list.</p> <p><b>c</b> Select the overlay you want to delete from the <b>Overlay List</b> box.</p> <p><b>d</b> Click <b>Delete</b>.</p> <p><b>e</b> When a confirming message window appears, click <b>Yes</b>.</p> <p><b>f</b> Click <b>OK</b> or <b>Print</b> until you exit the <b>Print</b> window. You can delete page overlays that you no longer use.</p>

a. This option is not available when you use XPS driver.

b. M287xND/M287xFD/M287xDW/M287xFW/M287xHN/M288xFW/M288xHW only.

# Printing features

## Using Direct Printing Utility



- Direct Printing Utility may not be available depending on model or optional goods (see "Software" on page 7).
- Available for Windows OS users only.

## What is Direct Printing Utility?

Direct Printing Utility is a program that sends the PDF files directly to your machine to print without having to open the file.

To install this program:

Download the software from the Samsung website then unpack and install it: (<http://www.samsung.com> > find your product > Support or Downloads).



- Optional memory Mass storage device (HDD) should be installed on your machine, to print files using this program (see "Variety feature" on page 10).
- You cannot print PDF files that are restricted. Deactivate the printing restriction feature and retry printing.
- You cannot print PDF files that are restricted by a password. Deactivate the password feature, and retry printing.
- Whether or not a PDF file can be printed using the Direct Printing Utility program depends on how the PDF file was created.

- The Direct Printing Utility program supports PDF version 1.7 and below. For higher versions, you must open the file to print it.

## Printing

There are several ways you can print using the Direct Printing Utility.

- 1 From the **Start** menu select **Programs** or **All Programs** .
  - For Windows 8, from **Charms**, select **Search** > **Apps**.
- 2 Find **Samsung Printers** > **Direct Printing Utility**.
- 3 Select your machine from the **Select Printer** drop-down list and click **Browse**.
- 4 Select the file you wish to print and click **Open**.  
The file is added in the **Select Files** section.
- 5 Customize the machine settings for your needs.
- 6 Click **Print**. The selected PDF file is sent to the machine.



# Printing features

## Using the right-click menu

---

- 1 Right-click on the PDF file to print and select **Direct Printing**.  
The Direct Printing Utility window appears with the PDF file is added.
- 2 Select the machine to use.
- 3 Customize the machine settings.
- 4 Click **Print**. The selected PDF file is sent to the machine.

## Mac printing



Some features may not be available depending on models or options. It means that the features are not supported.

## Printing a document

---

When you print with a Mac, you need to check the printer driver settings in each application you use. Follow the steps below to print from a Mac:

- 1 Open the document to print.
- 2 Open the **File** menu and click **Page Setup (Document Setup** in some applications).
- 3 Choose your paper size, orientation, scaling, other options, and make sure that your machine is selected. Click **OK**.
- 4 Open the **File** menu and click **Print**.
- 5 Choose the number of copies and indicate which pages to print.
- 6 Click **Print**.

# Printing features

## Changing printer settings

You can use advanced printing features when using your machine.

Open an application and select **Print** from the **File** menu. The machine name, which appears in the printer properties window, may differ depending on the machine in use. Except for the name, the composition of the printer properties window is similar to the following.

## Printing multiple pages on one sheet

You can print more than one page on a single sheet of paper. This feature provides a cost-effective way to print draft copies.

- 1 Open an application, and select **Print** from the **File** menu.
- 2 Select **Layout** from the drop-down list under **Orientation**. In the **Pages per Sheet** drop-down list, select the number of pages you want to print on one sheet of paper.
- 3 Select the other options to use.
- 4 Click **Print**.

The machine prints the selected number of pages to print on one sheet of paper.

## Printing on both sides of the paper



Some features may not be available depending on models or options. It means that the features are not supported (see "Features by model" on page 7).

Before printing in the duplex mode, decide on which edge you will be binding your finished document. The binding options are, as follows:

- **Long-Edge Binding:** This option is the conventional layout used in book binding.
- **Short-Edge Binding:** This option is the type often used with calendars.

- 1 From your Mac application, select **Print** from the **File** menu.
- 2 Select **Layout** from the drop-down list under **Orientation**.
- 3 Select a binding orientation from the **Two-Sided** option.
- 4 Select the other options to use.
- 5 Click **Print** and the machine prints on both sides of the paper.



If you print more than 2 copies, the first copy and the second copy might print on the same sheet of paper. Avoid printing on both sides of paper when you are printing more than 1 copy.

# Printing features

## Using help

Click the question mark on the bottom-left corner of the window and click on the topic you want to know about. A pop-up window appears with information about that option's feature, which is provided from the driver.

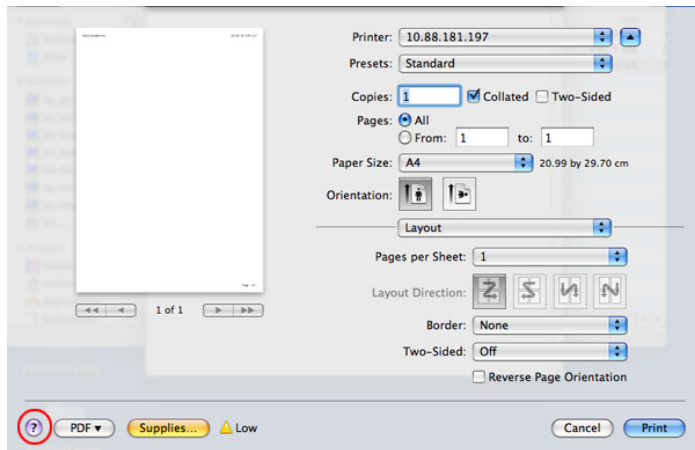

## Linux printing



Some features may not be available depending on models or options. It means that the features are not supported.

## Printing from applications

There are a lot of Linux applications that allow you to print using Common UNIX Printing System (CUPS). You can print on your machine from any such application.

- 1 Open the document to print.
- 2 Open the **File** menu and click **Page Setup** (**Print Setup** for some applications).
- 3 Choose your paper size, orientation, and make sure that your machine is selected. Click **Apply**.
- 4 Open the **File** menu and click **Print**.
- 5 Select your machine to print.
- 6 Choose the number of copies and indicate which pages to print.
- 7 Change other printing options in each tab, if necessary.
- 8 Click **Print**.



Automatic/manual duplex printing may not be available depending on models. You can alternatively use the lpr printing system or other applications for odd-even printing (see "Features by model" on page 7).

# Printing features

## Printing files

---

You can print text, image, pdf files on your machine using the standard CUPS directly from the command line interface. The CUPS lp or lpr utility allows you to do that. You can print these files by using below command format.

**"lp -d <printer name> -o <option> <file name>"**

Please refer to lp or lpr man page on your system for more details.

## Configuring Printer Properties

---

You can change the default printing options or connection type with Printing utility supplied by the OS.

- 1** Launch Printing utility(Go to **System > Administration > Printing** menu or execute "**system-config-printer**" command in Terminal program).
- 2** Select your printer and double-click it.
- 3** Change the default printing options or connection type.
- 4** Click the **Apply** button.

## Unix printing



Some features may not be available depending on models or options. It means that the features are not supported (see "Features by model" on page 7).

## Proceeding the print job

---

After installing the printer, choose any of the image, text, PS or HPGL files to print.

- 1** Execute "**printui <file\_name\_to\_print>**" command.  
For example, if you are printing "**document1**"  
**printui document1**  
This will open the UNIX Printer Driver **Print Job Manager** in which the user can select various print options.
- 2** Select a printer that has been already added.
- 3** Select the printing options from the window such as **Page Selection**.
- 4** Select how many copies are needed in **Number of Copies**.

# Printing features



To take advantage of the printer features provided by your printer driver, press **Properties**.

5

Press **OK** to start the print job.

## Changing the machine settings

The UNIX printer driver **Print Job Manager** in which the user can select various print options in printer **Properties**.

The following hot keys may also be used: "H" for **Help**, "O" for **OK**, "A" for **Apply**, and "C" for **Cancel**.

### General tab

- **Paper Size:** Set the paper size as A4, Letter, or other paper sizes, according to your requirements.
- **Paper Type:** Choose the type of the paper. Options available in the list box are **Printer Default**, **Plain**, and **Thick**.
- **Paper Source:** Select from which tray the paper is used. By default, it is **Auto Selection**.
- **Orientation:** Select the direction in which information is printed on a page.
- **Duplex:** Print on both sides of paper to save paper



Automatic/manual duplex printing may not be available depending on models. You can alternatively use the lpr printing system or other applications for odd-even printing (see "Features by model" on page 7).

- **Multiple pages:** Print several pages on one side of the paper.
- **Page Border:** Choose any of the border styles (e.g., **Single-line hairline**, **Double-line hairline**)

### Image tab

In this tab, you can change the brightness, resolution, or image position of your document.

### Text tab

Set the character margin, line space, or the columns of the actual print output.

### Margins tab

- **Use Margins:** Set the margins for the document. By default, margins are not enabled. The user can change the margin settings by changing the values in the respective fields. Set by default, these values depend on the page size selected.
- **Unit:** Change the units to points, inches, or centimeters.

# Printing features

## Printer-Specific Settings tab

Select various options in the **JCL** and **General** frames to customize various settings. These options are specific to the printer and depend on the PPD file.

# Scan features



- For basic scanning features, refer to the Basic Guide (see "Basic scanning" on page 66).
- This feature may not be available depending on model or optional goods (see "Features by model" on page 7).
- The maximum resolution that can be achieved depends upon various factors, including computer speed, available disk space, memory, the size of the image being scanned, and bit depth settings. Thus, depending on your system and what you are scanning, you may not be able to scan at certain resolutions, especially using enhanced dpi.

## Basic scanning method



- This feature may not be available depending on model or optional goods (see "Variety feature" on page 10).

You can scan the originals with your machine via a USB cable or the network. The following methodologies can be used for scanning your documents:

- **Scan to PC:** Scan the originals from the control panel. Then, the scanned data will be stored in the connected computers **My Documents** folder (see "Basic Scanning" on page 66).

- **TWAIN:** TWAIN is one of the preset imaging applications. Scanning an image launches the selected application, enabling you to control the scanning process. This feature can be used via the local connection or the network connection (see "Scanning from image editing program" on page 248).
- **Samsung Easy Document Creator:** You can use this program to scan images or documents. **We recommend using scan features with the Samsung Easy Document Creator program provided in the supplied software CD.**
  - See "Using Samsung Easy Document Creator" on page 269.
- **WIA:** WIA stands for Windows Images Acquisition. To use this feature, your computer must be connected directly with the machine via a USB cable (see "Scanning using the WIA driver" on page 249).

# Scan features

## Setting the scan settings in the computer



This feature may not be available depending on model or optional goods (see "Features by model" on page 7).

- 1 Open **Samsung Easy Printer Manager** (see "Using Samsung Easy Printer Manager" on page 270).
- 2 Select the appropriate machine from the **Printer List**.
- 3 Select **Scan to PC Settings** menu.
- 4 Select the option you want.
  - **Scan Activation:** Determines whether or not scanning is enabled on the device.
  - **Profile:** Displays the scanning profiles saved on the selected device.
  - **Basic** tab: Contains settings related to general scan and device settings.
  - **Image** tab: Contains settings related to image altering.
- 5 Press **Save > OK**.

## Scanning from network connected machine

Make sure the printer driver is installed on your computer using the software CD, since the printer driver includes the scan program (see "Installing the driver locally" on page 29).

- 1 Place a single document (see "Loading originals" on page 52).

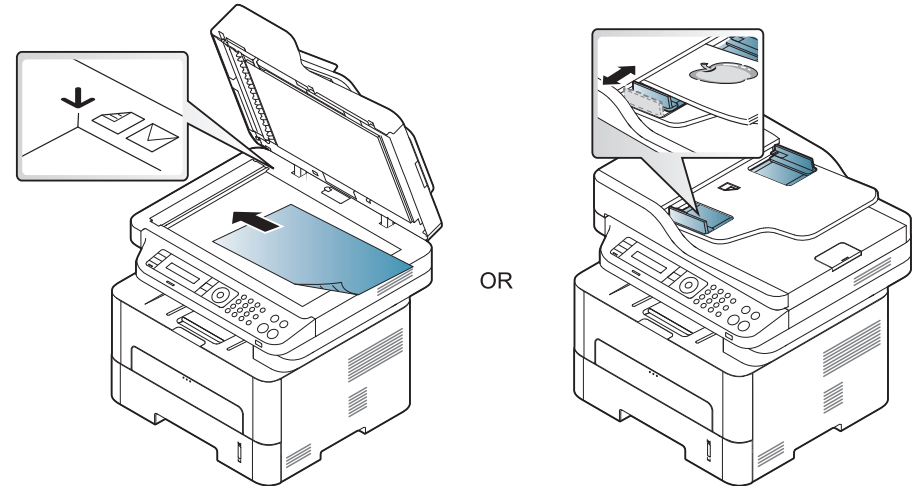

- 2 Select  (**Scan**) > **Scan to PC** > **Network PC** on the control panel.  
Or select **Scan to** button > **Scan to PC** > **Network PC** on the control panel.





If you see **Not Available** message, check the port connection.



# Scan features

- 3 Select your registered computer **ID**, and enter the **Password** if necessary.



- **ID** is the same ID as the registered scan ID for **Samsung Easy Printer Manager** >  Switch to advanced mode > **Scan to PC Settings**.
- **Password** is the 4 digit number registered password for **Samsung Easy Printer Manager** >  Switch to advanced mode > **Scan to PC Settings**.

- 4 Select the option you want and press **OK**.

- 5 Scanning begins.



Scanned image is saved in computer's **C:\Users\users name\Pictures\folder**. The saved folder may differ, depending on your operating system or the application you are using.

## Scanning to WSD

Scans the originals and saves the scanned data on a connected computer if the computer supports the WSD (Web Service for Device) feature. To use the WSD feature, you need to install the WSD printer driver on your computer. For Windows 7, you can install the WSD driver by **Control Panel > Devices and Printers > Add a printer**. Click **Add a network printer** from the wizard.



- The machine that does not support the network interface, it will not be able to use this feature (see "Features by model" on page 7).
- The WSD feature works only with Windows Vista® or later version that are the WSD-compliant computer.
- The following installation steps are based on Windows 7 computer.

## Installing a WSD Printer Driver

- 1 Select **Start > Control Panel > Devices and Printers > Add a printer**.
- 2 Click **Add a network, wireless or Bluetooth** printer from the wizard.
- 3 In the printers list, select the one you want to use, and then click **Next**.

# Scan features



- The IP address for WSD printer is `http://IP address/ws/` (example: `http://111.111.111.111/ws/`).
- If no WSD printer is displayed in the list, click **The printer that I want isn't listed** > **Add a printer using a TCP/IP address or hostname** and select **Web Services Device** from **Device type**. Then enter the printer's IP address.

- 4 Follow the instructions in the installation window.

## Scanning using the WSD feature

- 1 Make sure that the machine is connected to your computer and powered on.
- 2 Place a single document face down on the document glass, or load the documents face up into the document feeder (see Loading originals).
- 3 Select  (**Scan**) > **Scan to WSD** on the control panel.



If you see **Not Available** message, check the port connection. Or check the printer driver for WSD is correctly installed.

- 4 Select your computer name from **Destination List**.
- 5 Select the option you want and press **OK**.

- 6 Scanning begins.

## Scanning from image editing program

You can scan and import documents in the image editing software or using image editing software such as Adobe Photoshop, if the software is TWAIN-compliant. Follow the steps below to scan with TWAIN-compliant software:

- 1 Make sure that the machine is connected to your computer and powered on.
- 2 Place a single document (see "Loading originals" on page 52).

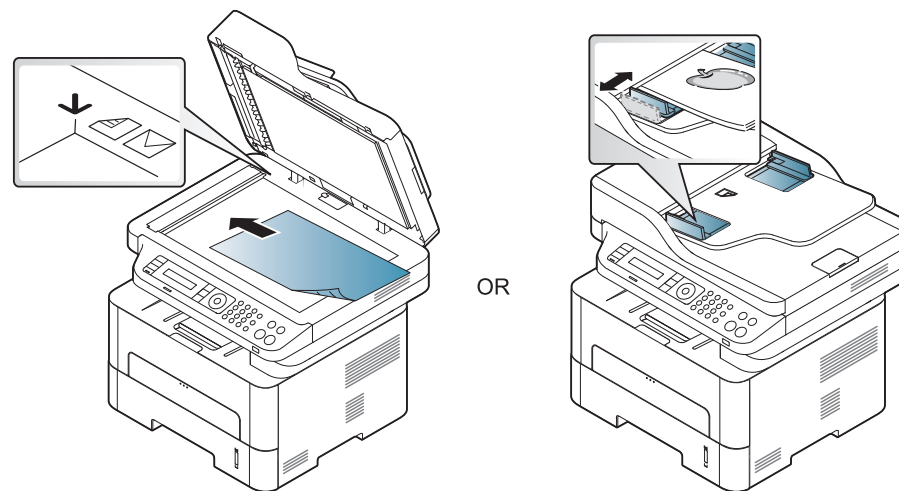

- 3 Open an application, such as Adobe Photoshop.

# Scan features

- 4 Click **File > Import**, and select the scanner device.
- 5 Set the scan options.
- 6 Scan and save your scanned image.

## Scanning using the WIA driver

Your machine supports the Windows Image Acquisition (WIA) driver for scanning images. WIA is one of the standard components provided by Microsoft Windows 7 and works with digital cameras and scanners. Unlike the TWAIN driver, the WIA driver allows you to scan and easily adjust images without using additional software:



The WIA driver works only on Windows OS with a USB port.

- 1 Make sure that the machine is connected to your computer and powered on.
- 2 Place a single document (see "Loading originals" on page 52).

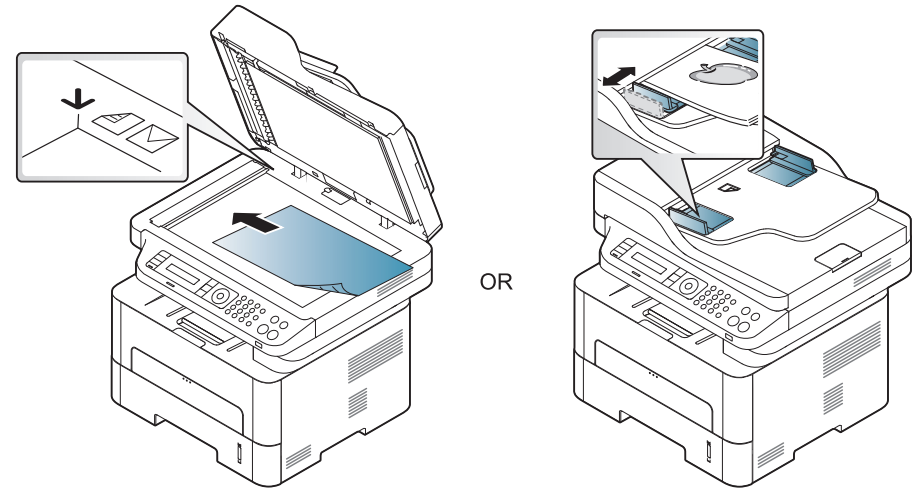

- 3 Click **Start > Control Panel > Hardware and Sound > Devices and Printers**.
- 4 Right-click on device driver icon in **Printers and Faxes > Start Scan**.
- 5 **New Scan** application appears.
- 6 Choose your scanning preferences and click **Preview** to see your preferences affect the picture.
- 7 Scan and save your scanned image.

# Scan features

## Mac scanning

### Scanning from USB connected machine

- 1 Make sure that the machine is connected to your computer and powered on.
- 2 Place a single document face down on the document glass, or load the documents face up into the document feeder (see "Loading originals" on page 52).
- 3 Start **Applications** and click **Image Capture**.

 If **No Image Capture device connected** message appears, disconnect the USB cable and reconnect it. If the problem continues, refer to the **Image Capture's** help.

- 4 Select the option you want.
- 5 Scan and save your scanned image.

 If scanning does not operate in **Image Capture**, update Mac OS to the latest version.

### Scanning from network connected machine



Network or wireless model only (see "Features by model" on page 7).

- 1 Make sure that your machine is connected to a network.
- 2 Place a single document face down on the document glass, or load the documents face up into the document feeder (see "Loading originals" on page 52).
- 3 Start **Applications** and click **Image Capture**.
- 4 According to OS, follow steps below.
  - For 10.5
    - Click **Devices > Browse Devices** on Menu bar.
    - Make sure that **Connected** checkbox is checked beside your machine in **Bonjour Devices**.
  - For 10.6-10.9, select your device below **SHARED**.
- 5 Set the scan options on this program.
- 6 Scan and save your scanned image.

# Scan features



- If scanning does not operate in Image Capture, update Mac OS to the latest version.
- For more information, refer to the **Image Capture's** help.
- You can also scan using TWAIN-compliant software, such as Adobe Photoshop.
- You can scan using Samsung Scan Assistant software. Open the **Applications** folder > **Samsung folder** > **Samsung Scan Assistant**.

## Linux scanning

- 1 Make sure that the machine is connected to your computer and powered on.
- 2 Launch a scan application such as xsane or simple-scan (If it's not installed, please install it manually to use scan features. For example, you may use "yum install xsane" for rpm package systems and "apt-get install xsane" for deb package systems to install xsane).
- 3 Select your device from the list and set the scan options to apply.
- 4 Click the **Scan** button.



# Fax features





- For basic faxing features, refer to the Basic Guide (see "Basic faxing" on page 67).
- M267xN/M287xND/M287xDW does not support fax features.

## Automatic redialing

When the number you have dialed is busy or there is no answer when you send a fax, the machine automatically redials the number. The redial time depends on the country's factory default setting.

When the display shows **Retry Redial?**, press  (**Start**) button to redial the number without waiting. To cancel the automatic redialing, press  (**Stop/Clear**).

To change the time interval between redials and the number of redial attempts.

- 1 Press  (fax) >  (**Menu**) > **Fax Setup** > **Sending** on the control panel.
- 2 Select **Redial Times** or **Redial Term** you want.
- 3 Select the option you want.

## Redialing the fax number

- 1 Press  (**Redial/Pause**) button on the control panel.
- 2 Select the fax number you want.  
Ten recently sent fax numbers with ten received Caller IDs are shown.
- 3 When an original is loaded in the document feeder, the machine automatically begins to send.  
If an original is placed on the scanner glass, select **Yes** to add another page. Load another original and press **OK**. When you have finished, select **No** when **Another Page?** appears.



## Confirming a transmission

When the last page of your original has been sent successfully, the machine beeps and returns to ready mode.

When something goes wrong while sending your fax, an error message appears on the display. If you receive an error message, press  (**Stop/Clear**) to clear the message and try to send the fax again.

# Fax features



You can set your machine to print a confirmation report automatically each time sending a fax is completed. Press  (fax) >  (**Menu**) > **System Setup** > **Report** > **Fax Confirm**. on the control panel.

## Sending a fax in the computer



This feature may not be available depending on model or optional goods (see "Features by model" on page 7).

You can send a fax from your computer without going to the machine.

To send a fax from your computer, the **Samsung Network PC Fax** program must be installed. This program will be installed when you installed the printer driver.

- 1 Open the document to be sent.
- 2 Select **Print** from the **File** menu.  
The **Print** window will be displayed. It may look slightly different depending on your application.
- 3 Select **Samsung Network PC Fax** from the **Print** window

4 Click **Print** or **OK**.

5 Enter the recipients' numbers and select the option





Select the **Help** button from the window and click on any option you want to know about.

6 Click **Send**.

## Delaying a fax transmission

You can set your machine to send a fax at a later time when you will not be present. You cannot send a color fax using this feature.

- 1 Place a single document face down on the document glass, or load the documents face up into the document feeder.
- 2 Press  (fax) on the control panel.
- 3 Adjust the resolution and the darkness to suit your fax needs.
- 4 Press  (**Menu**) > **Fax Feature** > **Delay Send** on the control panel.
- 5 Enter the number of the receiving fax machine and press **OK**.
- 6 The display asks you to enter another fax number to send the document.

# Fax features

- 7** To enter more fax numbers, press **OK** when **Yes** highlights and repeat steps 5.



- You can add up to 10 destinations.
- Once you entered a group dial number, you cannot enter another group dial numbers anymore.

- 8** Enter the job name and the time.



If you set a time earlier than the current time, the fax will be sent at that time on the following day.

- 9** The original is scanned into memory before transmission.



The machine returns to ready mode. The display reminds you that you are in ready mode and that a delayed fax is set.





You can check the list of delayed fax jobs.

Press  (**Menu**) > **System Setup** > **Report** > **Scheduled Jobs** on the control panel.

## Adding documents to a reserved fax

- 1** Place a single document face down on the document glass, or load the documents face up into the document feeder.
- 2** Press  (fax) >  (**Menu**) > **Fax Feature** > **Add Pages** on the control panel.
- 3** Select the fax job and press **OK**.  
When you have finished, select **No** when **Another Page?** appears. The machine scans the original into memory.
- 4** Press  (**Stop/Clear**) to return to ready mode.

## Canceling a reserved fax job



- 1** Press  (fax) >  (**Menu**) > **Fax Feature** > **Cancel Job** on the control panel.
- 2** Select the fax job you want and press **OK**.
- 3** Press **OK** when **Yes** highlights.  
The selected fax is deleted from memory.
- 4** Press  (**Stop/Clear**) to return to ready mode.



# Fax features

## Sending a priority fax

This function is used when a high priority fax need to be sent ahead of reserved operations. The original is scanned into memory and immediately transmitted when the current operation is finished.

- 1 Place a single document face down on the document glass, or load the documents face up into the document feeder.
- 2 Press  (**Fax**) >  (**Menu**) > **Fax Feature** > **Priority Send** on the control panel.
- 3 Enter the destination fax number and press **OK**.
- 4 Enter the job name and press **OK**.
- 5 If an original is placed on the scanner glass, select **Yes** to add another pages. Load another original and press **OK**.

When you have finished, select **No** when **Another Page?** appears.

The machine starts to scan and send a fax to destinations.

## Forwarding a sent fax to another destination

You can set the machine to forward the sent fax to other destination by a fax. If you are out of office but have to receive the fax, this feature may be useful.



- Though you sent or received a color fax, the data is forwarded in grayscale.

- 1 Place a single document (see "Loading originals" on page 52).

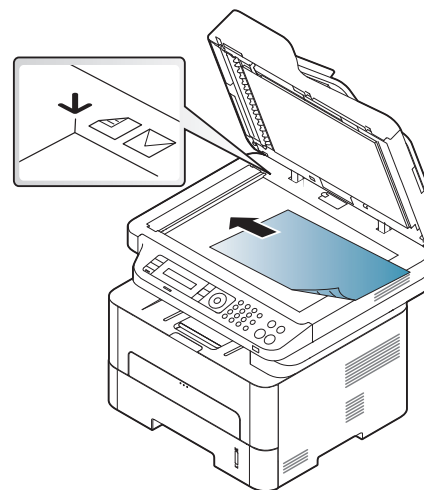

OR

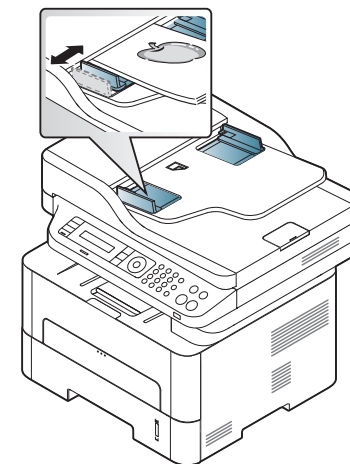

- 2 Press  (fax) >  (**Menu**) > **Fax Feature** > **Send Forward** > **Forward to Fax** > **On** on the control panel.

# Fax features



**Forward** options may not be available depending on model or optional goods (see "Variety feature" on page 10).

- 3 Enter the destination fax number and press **OK**.
- 4 Press  (**Stop/Clear**) to return to ready mode.  
Subsequent sent faxes will be forwarded to the specified fax machine.

## Forwarding a received fax

You can set the machine to forward the received fax to other destination by a fax or a PC. If you are out of office but have to receive the fax, this feature may be useful.



Though you sent or received a color fax, the data is forwarded in grayscale.

- 1 Press  (fax) >  (**Menu**) > **Fax Feature** > **Rcv. Forward** > **Forward to Fax**, or **Forward to PC** > **On** on the control panel.







**Forward** options may not be available depending on model or optional goods (see "Variety feature" on page 10).

- 2 To set the machine to print out a fax when fax forwarding has been completed, select **Forward & Print**.
- 3 Enter the destination fax number and press **OK**.
- 4 Enter the starting time and ending time, then press **OK**.
- 5 Press  (**Stop/Clear**) to return to ready mode.  
Subsequent sent faxes will be forwarded to the specified fax machine.

# Fax features

## Changing the receive modes

- 1 Press  (fax) >  (**Menu**) > **Fax Setup** > **Receiving** > **Receive Mode** on the control panel.
- 2 Select the option you want.
  - **Fax:** Answers an incoming fax call and immediately goes into the fax reception mode.
  - **Tel:** Receives a fax by pressing  (**On Hook Dial**) and then  (**Start**)
  - **Ans/Fax:** Is for when an answering machine attached to your machine. Your machine answers an incoming call, and the caller can leave a message on the answering machine. If the fax machine senses a fax tone on the line, the machine automatically switches to Fax mode to receive the fax.



To use the **Ans/Fax** mode, attach an answering machine to the EXT socket on the back of your machine.



- **DRPD:** you can receive a call using the Distinctive Ring Pattern Detection (DRPD) feature. Distinctive Ring is a telephone company service which enables an user to use a single telephone line to answer several different telephone numbers. For further details, see "Receiving faxes using DRPD mode" on page 258.



This setting may not be available depending on your country.

- 3 Press **OK**.
- 4 Press  (**Stop/Clear**) to return to ready mode.

## Receiving manually in Tel mode

You can receive a fax call by pressing  (**On Hook Dial**) button and then pressing  (**Start**) when you hear a fax tone. If your machine has a handset, you can answer calls using the handset (see "Features by model" on page 7).

## Receiving in Answering Machine/Fax mode

To use this mode, you must attach an answering machine to the EXT socket on the back of your machine. If the caller leaves a message, the answering machine stores the message. If your machine detects a fax tone on the line, it automatically starts to receive the fax.

# Fax features



- If you have set your machine to this mode and your answering machine is switched off, or no answering machine is connected to EXT socket, your machine automatically goes into Fax mode after a predefined number of rings.
- If the answering machine has a user-selectable ring counter, set the machine to answer incoming calls within 1 ring.
- If the machine is in Tel mode, disconnect or switch off the answering machine with the fax machine. Otherwise, the outgoing message from the answering machine will interrupt your phone conversation.

## Receiving faxes with an extension telephone

When you are using an extension telephone connected to the EXT socket, you can receive a fax from someone you are talking to on the extension telephone, without going to the fax machine.

When you receive a call on the extension phone and hear fax tones, press the keys **\*9\*** on the extension phone. The machine receives the fax.



**\*9\*** is the remote receive code preset at the factory. The first and the last asterisks are fixed, but you can change the middle number to whatever you want.



While you are talking over the telephone connected to the EXT socket, copy and scan features are not available.

## Receiving faxes using DRPD mode

Distinctive Ring is a telephone company service which enables an user to use a single telephone line to answer several different telephone numbers. This feature is often used by answering services who answer telephones for many different clients and need to know which number someone is calling in on to properly answer the phone.

- 1 Select  (fax) >  (**Menu**) > **Fax Setup** > **Receiving** > **DRPD** > **Waiting Ring** on the control panel.
- 2 Call your fax number from another telephone.
- 3 When your machine begins to ring, do not answer the call. The machine requires several rings to learn the pattern.  
  
When the machine completes learning, the display shows **Completed DRPD Setup**. If the DRPD setup fails, **Error DRPD Ring** appears.
- 4 Press **OK** when DRPD appears and start over from step 2.



- DRPD must be set up again if you re-assign your fax number, or connect the machine to another telephone line.
- After DRPD has been set up, call your fax number again to verify that the machine answers with a fax tone. Then have a call placed to a different number assigned to that same line to be sure the call is forwarded to the extension telephone or answering machine plugged into the EXT socket.

# Fax features



## Receiving in secure receiving mode





This feature may not be available depending on model or optional goods (see "Features by model" on page 7).

You may need to prevent your received faxes from being accessed by unauthorized people. Turn on secure receiving mode, then all incoming faxes go into memory. You can print the incoming faxes by entering the password.



To use the secure receiving mode, activate the menu from  (fax) >  (Menu) > **Fax Feature** > **Secure Receive** on the control panel.



## Printing received faxes

- 1 Select  (fax) >  (Menu) > **Fax Feature** > **Secure Receive** > **Print** on the control panel.
- 2 Enter a four-digit password and press **OK**.
- 3 The machine prints all of the faxes stored in memory.

## Printing faxes on both sides of the paper



- Some menus may not appear on the display depending on options or models. If so, it is not applicable to your machine.
- This feature may not be available depending on model or optional goods (see "Features by model" on page 7).

- 1 Place a single document face down on the document glass, or load the documents face up into the document feeder.
- 2 Press  (fax) >  (Menu) > **Fax Setup** > **Receiving** > **Duplex Print** on the control panel.
  - **Off:** Prints in Normal mode.
  - **Long Edge:** Prints pages to be read like a book.

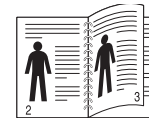

- **Short Edge:** Prints pages to be read by flipping like a note pad.

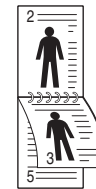

# Fax features

- 3 Press **OK**.
- 4 Press  (**Stop/Clear**) to return to ready mode.

## Receiving faxes in memory



Since your machine is a multi-tasking device, it can receive faxes while you are making copies or printing. If you receive a fax while you are copying or printing, your machine stores incoming faxes in its memory. Then, as soon as you finish copying or printing, the machine automatically prints the fax.



If fax is received and being printed, other copy and print jobs cannot be processed at the same time.

## Printing sent fax report automatically

You can set the machine to print a report with detailed information about the previous 50 communication operations, including time and dates.

- 1 Press  (fax) >  (**Menu**) > **System Setup** > **Report** > **Fax Sent** on the control panel.
- 2 Press  (**Stop/Clear**) to return to ready mode.



# 5. Useful Management Tools

This chapter introduces management tools provided to help you make full use of your machine.

- **Accessing management tools** 262
- **Easy Capture Manager** 263
- **Samsung AnyWeb Print** 264
- **Easy Eco Driver** 265
- **Using SyncThru™ Web Service** 266
- **Using Samsung Easy Document Creator** 269
- **Using Samsung Easy Printer Manager** 270
- **Using Samsung Printer Status** 273
- **Using Samsung Printer Experience** 275

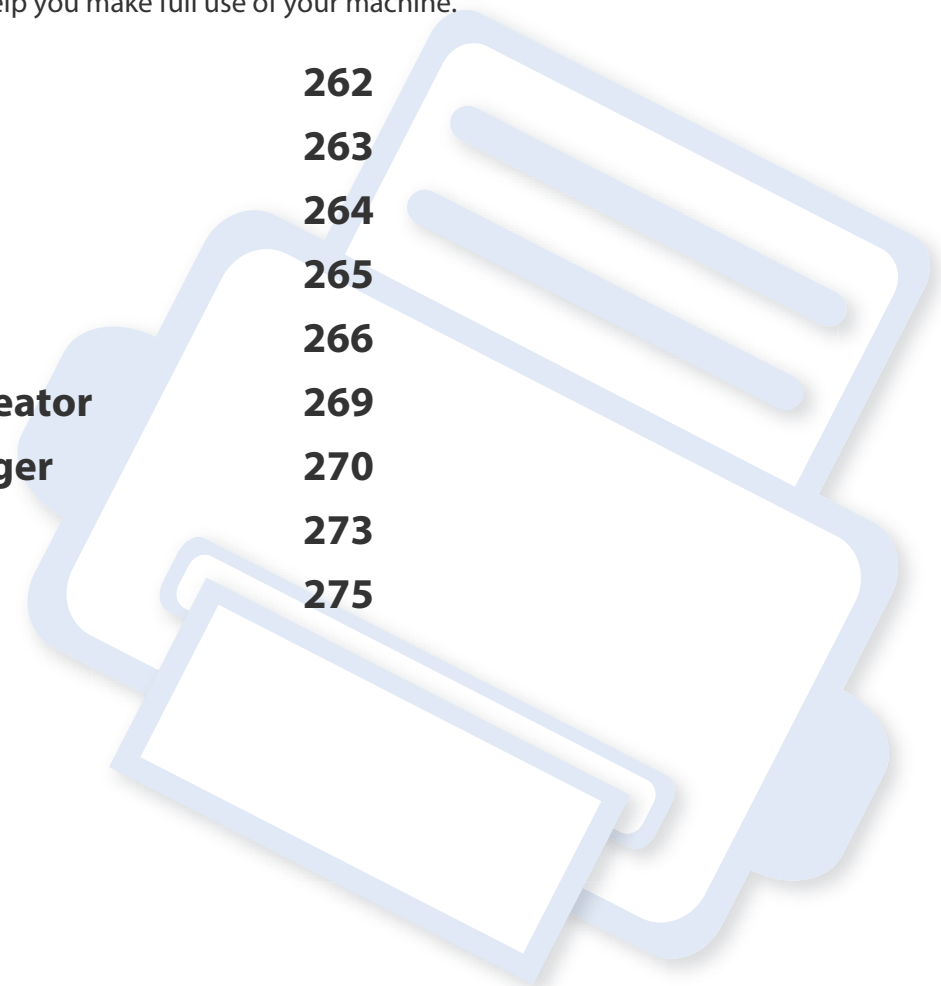

# Accessing management tools

Samsung provides a variety of management tools for Samsung printers.

- 1 Make sure that the machine is connected to your computer and powered on.
- 2 From the **Start** menu, select **Programs** or **All Programs**.
  - For Windows 8, from the **Charms**, select **Search > Apps**.
- 3 Find **Samsung Printers**.
- 4 Under **Samsung Printers**, you can see installed management tools.
- 5 Click the management tool you want to use.



- After installing the driver, for some management tools, you can access them directly from the **Start** menu > **Programs** or **All Programs**.
- For Windows 8, after installing the driver, for some management tools, you can access them directly from the **Start** screen by clicking on the corresponding tile.



# Easy Capture Manager



- Available for Windows OS users only.
- This feature may not be available depending on model or optional goods (see "Software" on page 7).

Capture your screen and launch Easy Capture Manager by simply pressing the Print Screen key. Now you can easily print your captured screen as captured or edited.

# Samsung AnyWeb Print



- This feature may not be available depending on model or optional goods (see "Software" on page 7).
- Available for Windows OS users only.

This tool helps you screen-capture, preview, scrap, and print Windows Internet Explorer pages more easily than when you use an ordinary program. Download the software from the Samsung website then unpack and install it: (<http://www.samsung.com> > find your product > Support or Downloads).

# Easy Eco Driver



- This feature may not be available depending on model or optional goods (see "Software" on page 7).
- Available for Windows OS users only (see "Software" on page 7).

With the Easy Eco Driver, you can apply Eco features to save paper and toner before printing.

Easy Eco Driver also allows you simple editing such as removing images and texts, and more. You can save frequently used settings as a preset.

## How to use:

- 1 Open a document to print.
- 2 Open **printing preference window** (see "Opening printing preferences" on page 57).
- 3 From the **Favorites** tab, select **Eco Printing Preview**.
- 4 Click **OK > Print** in the window.  
A preview window appears.
- 5 Select the options you want to apply to the document.  
You can see the preview of the applied features.
- 6 Click **Print**.



If you want to run Easy Eco Driver every time you print, check **Start Easy Eco Driver before printing job** checkbox in the **Basic** tab of the printing preference window.

# Using SyncThru™ Web Service



- Internet Explorer 6.0 or higher is the minimum requirement for SyncThru™ Web Service.
- SyncThru™ Web Service explanation in this user's guide may differ from your machine depending on its options or models.
- Network model only (see "Software" on page 7).

## Accessing SyncThru™ Web Service

- 1 Access a web browser, such as Internet Explorer, from Windows.  
Enter the machine IP address of your printer (<http://xxx.xxx.xxx.xxx>) in the address field and press the Enter key or click **Go**.
- 2 Your machine's embedded website opens.

## Logging into SyncThru™ Web Service

Before configuring options in SyncThru™ Web Service, you need to log-in as an administrator. You can still use SyncThru™ Web Service without logging in but you won't have access to **Settings** tab and **Security** tab.

- 1 Click **Login** on the upper right of the SyncThru™ Web Service website.
- 2 Type in the **ID** and **Password** then click **Login**.
  - **ID: admin**
  - **Password: sec00000**

## SyncThru™ Web Service overview



Information

Settings

Security

Maintenance



Some tabs may not appear depending on your model.

## Information tab

This tab gives you general information about your machine. You can check things, such as remaining amount of toner. You can also print reports, such as an error report.

- **Active Alerts:** Shows the alerts that have occurred in the machine and their severity.
- **Supplies:** Shows how many pages are printed and amount of toner left in the cartridge.

# Using SyncThru™ Web Service

- **Usage Counters:** Shows the usage count by print types: simplex and duplex.
- **Current Settings:** Shows the machine's and network's information.
- **Print information:** Prints reports such as system related reports, e-mail address, and font reports.

## Settings tab

---

This tab allows you to set configurations provided by your machine and network. You need to log-in as an administrator to view this tab.

- **Machine Settings** tab: Sets options provided by your machine.
- **Network Settings** tab: Shows options for the network environment. Sets options such as TCP/IP and network protocols.

## Security tab

---

This tab allows you to set system and network security information. You need to log-in as an administrator to view this tab.

- **System Security:** Sets the system administrator's information and also enables or disables machine features.
- **Network Security:** Sets settings for IPSec, and IPv4/IPv6 filtering.

## Maintenance tab

---

This tab allows you to maintain your machine by upgrading firmware and setting contact information for sending emails. You can also connect to Samsung website or download drivers by selecting the **Link** menu.

- **Firmware Upgrade:** Upgrade your machine's firmware.
- **Contact Information:** Shows the contact information.
- **Link:** Shows links to useful sites where you can download or check information.

## E-mail notification setup

You can receive emails about your machine's status by setting this option. By setting information such as IP address, host name, e-mail address and SMTP server information, the machine status (toner cartridge shortage or machine error) will be sent to a certain person's e-mail automatically. This option may be used more frequently by a machine administrator.

- 1 Start a web browser, such as Internet Explorer, from Windows.  
Enter the machine IP address (http://xxx.xxx.xxx.xxx) in the address field and press the Enter key or click **Go**.
- 2 Your machine's embedded website opens.
- 3 From the **Settings** tab, select **Machine Settings > E-mail Notification**.

# Using SyncThru™ Web Service



If you have not configured outgoing server environment, go to **Settings > Network Settings > Outgoing Mail Server(SMTP)** to configure network environment before setting e-mail notification.

**4** Select **Enable** check box to use the **E-mail Notification**.

**5** Click **Add** button to add e-mail notification user.

Set the recipient name and e-mail address(es) with notification items you want to receive an alert for.

**6** Click **Apply**.



If the firewall is activated, the e-mail may not be sent successfully. In that case, contact a network administrator.

## Setting the system administrator's information

This setting is necessary for using the e-mail notification option.

- 1** Start a web browser, such as Internet Explorer, from Windows.  
Enter the machine IP address (http://xxx.xxx.xxx.xxx) in the address field and press the Enter key or click **Go**.
- 2** Your machine's embedded website opens.
- 3** From the **Security** tab, select **System Security > System Administrator**
- 4** Enter the name of the administrator, phone number, location, and email address.
- 5** Click **Apply**.

# Using Samsung Easy Document Creator

Samsung Easy Document Creator is an application to help users scan, compile, and save documents in multiple formats, including .epub format. These documents can be shared via social networking sites or fax. Whether you're a student needing to organize research from the library or a stay-at-home mom sharing scanned pictures from last year's birthday party, Samsung Easy Document Creator will provide you with the necessary tools.

The Samsung Easy Document Creator provides features below:

- **Image Scanning:** Use for scanning single or multiple pictures.
- **Document Scanning:** Use for scanning documents with text or text and images.
- **Text Converting:** Use for scanning documents that need to be saved in an editable text format.
- **Book Scanning:** Use for scanning books with the flatbed scanner.
- **SNS Upload:** Provides an easy and quick way to upload scanned image or existing images to a variety of social networking sites (SNS).
- **E-Book Conversion:** Provides the ability to scan multiple documents in as one e-book or convert existing files into an e-book format.
- **Plug-in:** Scan, fax, and convert to E-Book directly from the Microsoft Office program.



Click the **Help** (?) button from the window and click on any option you want to know about.

# Using Samsung Easy Printer Manager



- This feature may not be available depending on model or optional goods (see "Software" on page 7).
- Available for Windows and Mac OS users only (see "Software" on page 7).
- For Windows, Internet Explorer 6.0 or higher is the minimum requirement for Samsung Easy Printer Manager.

Samsung Easy Printer Manager is an application that combines Samsung machine settings into one location. Samsung Easy Printer Manager combines device settings as well as printing environments, settings/actions and launching. All of these features provide a gateway to conveniently use your Samsung machine. Samsung Easy Printer Manager provides two different user interfaces for the user to choose from: the basic user interface and the advanced user interface. Switching between the two interfaces is easy: just click a button.

## Understanding Samsung Easy Printer Manager

To open the program:

### For Windows,

Select **Start > Programs** or **All Programs > Samsung Printers > Samsung Easy Printer Manager > Samsung Easy Printer Manager**.

- For Windows 8, from **Charms**, select **Search > Apps > Samsung Printers > Samsung Easy Printer Manager > Samsung Easy Printer Manager**.

### For Mac,

Open the **Applications** folder > **Samsung** folder > **Samsung Easy Printer Manager**.

The Samsung Easy Printer Manager interface is comprised of various basic sections as described in the table that follows:



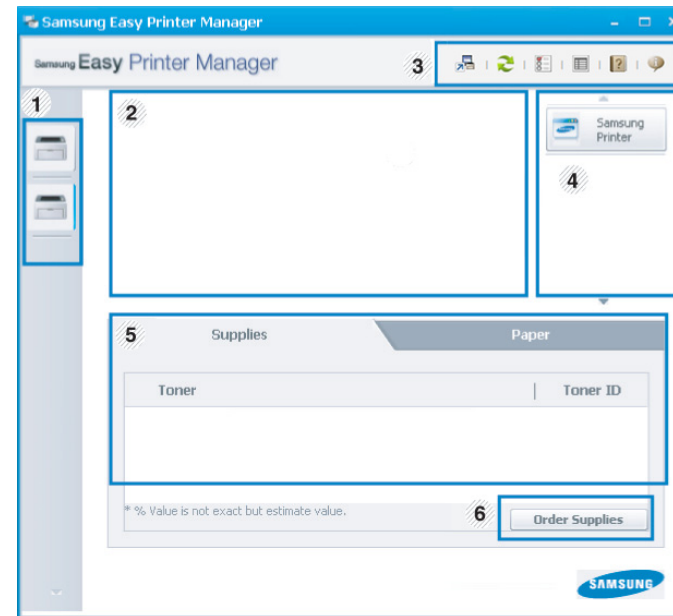

The screenshot may differ depending on the operating system you are using.



1	Printer list	The Printer List displays printers installed on your computer and network printers added by network discovery (Windows only).
---	--------------	---



# Using Samsung Easy Printer Manager

2	Printer information	<p>This area gives you general information about your machine. You can check information, such as the machine's model name, IP address (or Port name), and machine status.</p> <p> You can view the online <b>User's Guide</b>.</p> <p><b>Troubleshooting button:</b> This button opens the <b>Troubleshooting Guide</b> when an error occurs. You can directly open the necessary section in the user's guide.</p>
3	<b>Application information</b>	<p>Includes links for changing to the advanced settings, preference, help, and about.</p> <p> The  button is used to change the user interface to the <b>advanced settings user interface</b> (see "Advanced settings user interface overview" on page 271).</p>

4	Quick links	<p>Displays <b>Quick links</b> to machine specific functions. This section also includes links to applications in the advanced settings.</p> <p> If you connect your machine to a network, the SyncThru™ Web Service icon is enabled.</p>
5	Contents area	<p>Displays information about the selected machine, remaining toner level, and paper. The information will vary based on the machine selected. Some machines do not have this feature.</p>
6	Order supplies	<p>Click on the <b>Order</b> button from the supply ordering window. You can order replacement toner cartridge(s) from online.</p>



Select the **Help** menu or click the  button from the window and click on any option you want to know about.

## Advanced settings user interface overview

The advanced user interface is intended to be used by the person responsible for managing the network and machines.

# Using Samsung Easy Printer Manager



Some menus may not appear in the display depending on options or models. If so, it is not applicable to your machine.

## Device Settings

---

You can configure various machine settings such as machine setup, paper, layout, emulation, network, and print information.

## Scan to PC Settings

---

This menu includes settings to create or delete scan to PC profiles.

- **Scan Activation:** Determines whether or not scanning is enabled on the device.
- **Basic** tab: Contains general scan and device settings.
- **Image** tab: Contains settings related to image altering.

## Fax to PC Settings

---

This menu includes settings related to the basic fax functionality of the selected device.

- **Disable:** If **Disable** is **On**, incoming faxes will not be received on this device.
- **Enable Fax Receiving from Device:** Enables faxing on the device and allows more options to be set.

## Alert Settings (Windows only)

---

This menu includes settings related to error alerting.

- **Printer Alert:** Provides settings related to when alerts will be received.
- **Email Alert:** Provides options relating to receiving alerts via email.
- **Alert History:** Provides a history of device and toner related alerts.

## Job Accounting

---

Provides querying of quota information of the specified job accounting user. This quota information can be created and applied to devices by job accounting software such as SyncThru™ or CounThru™ admin software.

# Using Samsung Printer Status

The Samsung Printer Status is a program that monitors and informs you of the machine status.



- The Samsung Printer Status window and its contents shown in this user's guide may differ depending on the machine or operating system in use.
- Check the operating system(s) that are compatible with your machine (see "Specifications" on page 116).
- Available for Windows OS users only (see "Software" on page 7).

## Samsung Printer Status overview

If an error occurs while operating, you can check the error from the Samsung Printer Status. Samsung Printer Status is installed automatically when you install the machine software.

You can also launch Samsung Printer Status manually. Go to the **Printing Preferences**, click the **Basic** tab > **Printer Status** button.

These icons appear on the Windows task bar:

Icon	Mean	Description
	Normal	The machine is in ready mode and experiencing no errors or warnings.
	Warning	The machine is in a state where an error might occur in the future. For example, it might be in toner low status, which may lead to toner empty status.
	Error	The machine has at least one error.

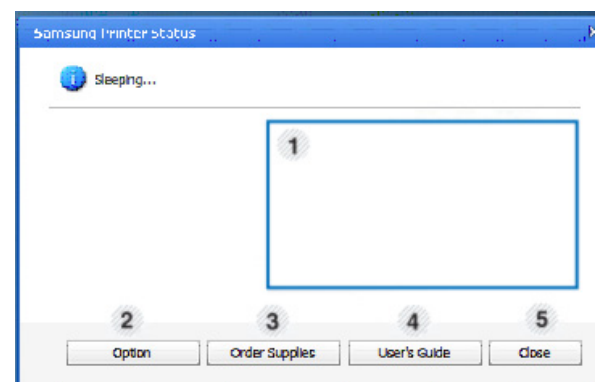

1	<b>Toner Level</b>	You can view the level of toner remaining in each toner cartridge. The machine and the number of toner cartridge(s) shown in the above window may differ depending on the machine in use. Some machines do not have this feature.
2	<b>Option</b>	You can set printing job alert related settings.

# Using Samsung Printer Status

3	<b>Order Supplies</b>	You can order replacement toner cartridge(s) from online.
4	<b>User's Guide</b>	<p>You can view the online User's Guide.</p> <div data-bbox="421 395 1084 639"> This button opens the <b>Troubleshooting Guide</b> when an error occurs. You can directly open the troubleshooting section in the user's guide.</div>
5	<b>Close</b>	Close the window.

# Using Samsung Printer Experience

**Samsung Printer Experience** is a Samsung application that combines Samsung machine settings and machine management into one location. You can set device settings, order supplies, open troubleshooting guides, visit Samsung's web site, and check connected machine information. This application will be automatically downloaded from the Windows **Store** if the machine is connected to a computer with an Internet connection.

## Understanding the Samsung Printer Experience

To open the application,

From the **Start** screen, select the **Samsung Printer Experience** (  ) tile.

The **Samsung Printer Experience** interface comprises various useful features as described in the following table:

 The screenshot may differ depending on the model you are using.

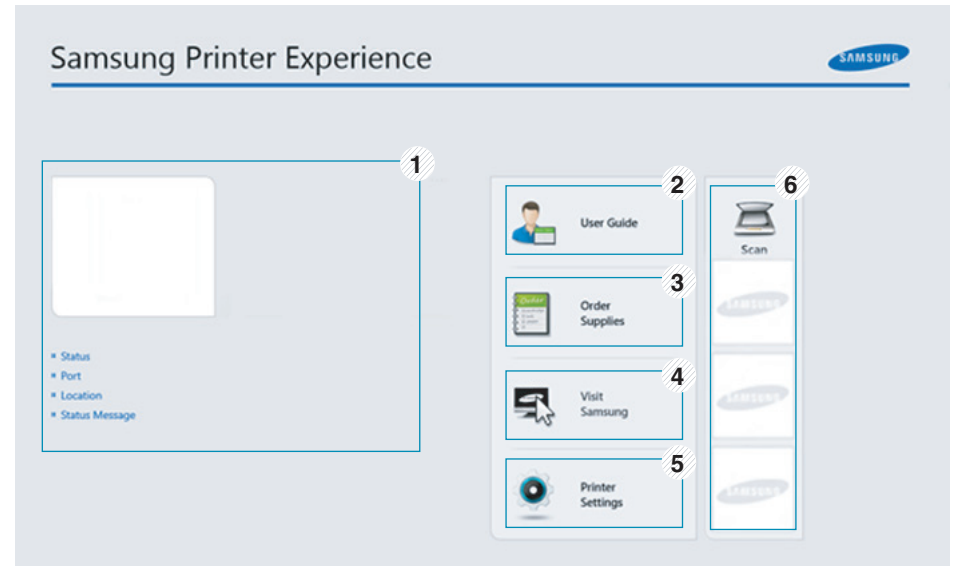

1	<b>Printer Information</b>	This area gives you general information about your machine. You can check information, such as the machine's status, location, IP address, and remaining toner level.
---	----------------------------	---

# Using Samsung Printer Experience

2	<b>User Guide</b>	You can view the online User's Guide. You need to be connected to the Internet to use this feature.   This button opens the <b>Troubleshooting Guide</b> when an error occurs. You can directly open the troubleshooting section in the user's guide.
3	<b>Order Supplies</b>	Click on this button to order replacement toner cartridges online. You need to be connected to the Internet to use this feature.
4	<b>Visit Samsung</b>	Links to Samsung printer website. You need to be connected to the Internet to use this feature.
5	<b>Printer Settings</b>	You can configure various machine settings such as machine setup, paper, layout, emulation, networking, and print information through <b>SyncThru™ Web Service</b> . Your machine needs to be connected to a network. This button will be disabled if your machine is connected via USB cable.
6	<b>Device List &amp; Latest Scanned Image</b>	The scan list displays devices that supports <b>Samsung Printer Experience</b> . Under the device, you can see the latest scanned images. Your machine needs to be connected to a network to scan from here.  This section is for the users with multi-functional printers.

## Adding/Deleting Printers

If you do not have any printer added to the **Samsung Printer Experience**, or if you want to add/delete a printer, follow the instructions below.



You can only add/delete network connected printers.

## Adding a printer

- 1 From the **Charms**, select **Settings**.  
Or, right-click the **Samsung Printer Experience** page and select **Settings**.
- 2 Select **Add Printer**
- 3 Select the printer you want to add.  
You can see the added printer.



If you see  mark, you can also click  mark to add printers.

# Using Samsung Printer Experience

## Deleting a printer

- 1 From the **Charms**, select **Settings**.  
Or, right-click the **Samsung Printer Experience** page and select **Settings**.
- 2 Select **Remove Printer**
- 3 Select the printer you want to delete.
- 4 Click **Yes**.  
You can see that the deleted printer is removed from the screen.

## Printing from Windows 8

This section explains common printing tasks from the **Start** screen.

## Basic printing

- 1 Open the document to print.
- 2 From the **Charms**, select **Devices**.
- 3 Select your printer from the list

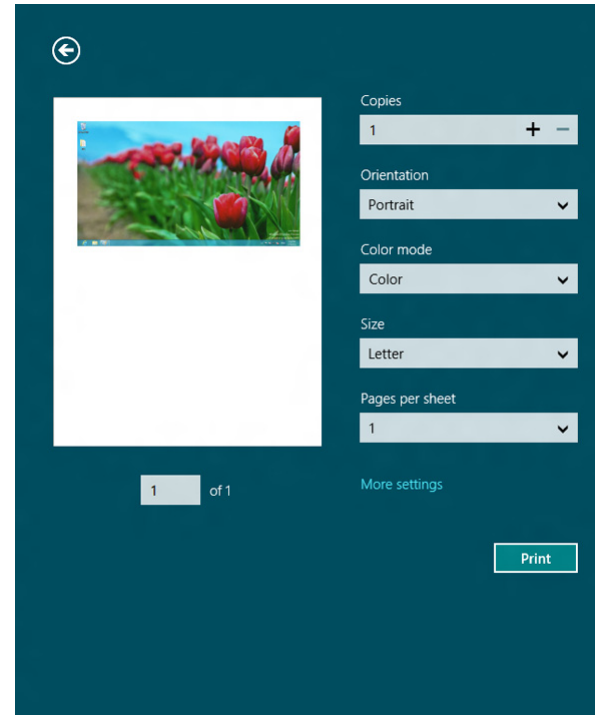

- 4 Select the printer settings, such as the number of copies and orientation.
- 5 Click the **Print** button to start the print job.



# Using Samsung Printer Experience

## Canceling a print job

If the printing job is waiting in the print queue or print spooler, cancel the job as follows:

- You can access this window by simply double-clicking the machine icon (  ) in the Windows task bar.
- You can also cancel the current job by pressing  (**Stop/Clear**) button on the control panel.

## Opening more settings



The screen may appear somewhat different depending on the model or options.

You can set up more printing parameters.

- 1 Open the document you want to print.
- 2 From the **Charms**, select **Devices**.
- 3 Select your printer from the list
- 4 Click **More settings**.

## Basic tab

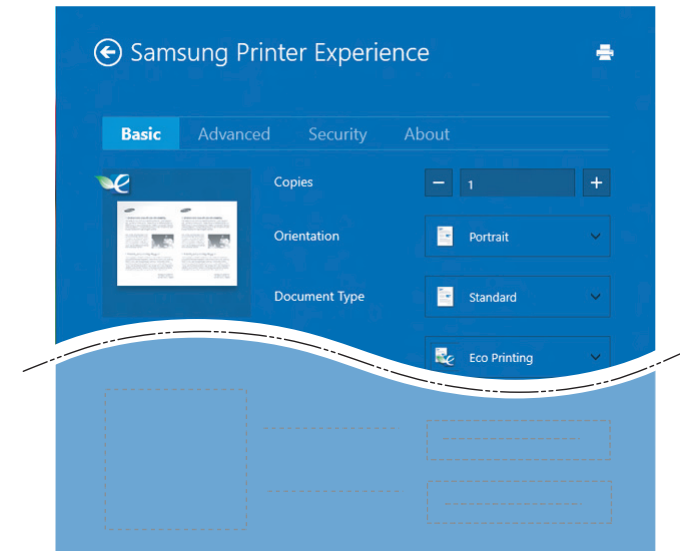

### Basic

This option allows you to choose the basic printing settings such as copies, orientation, and document type.

### Eco settings

This option allows you to choose multiple pages per side to save media.



# Using Samsung Printer Experience

## Advanced tab



### Paper settings

This option allows you to set the basic paper handling specifications.

### Layout settings

This option allows you to set the various ways to layout your documents.

## Security tab



Some features may not be available depending on the model or options. If this tab is not shown or disabled, it means that these features are not supported.

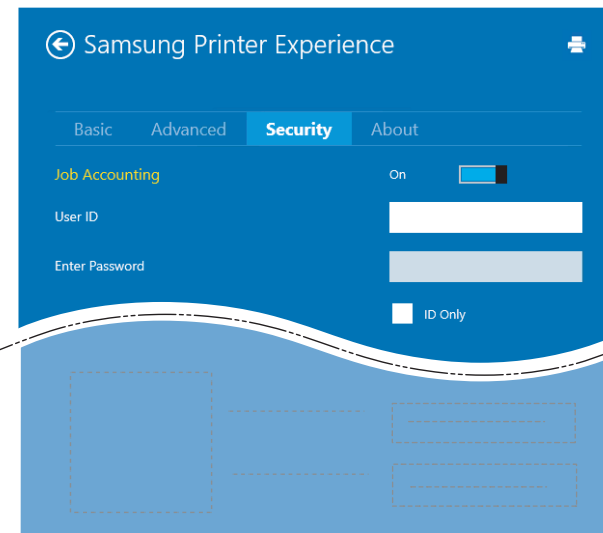

### Job Accounting

This option allows you to print with the given permission.

### Confidential Printing

This option is used for printing confidential documents. You need to enter a password to print using it.

# Using Samsung Printer Experience

## Scanning from Windows 8





This section is for the users with multi-functional printers.

Scanning with your machine lets you turn pictures and text into digital files that can be stored on your computer.

## Scanning from Samsung Printer Experience

The most frequently used printing menus are displayed for quick scanning.

- 1 Place a single document face down on the document glass, or load the documents face up into the document feeder.
- 2 Click the **Samsung Printer Experience** tile on the **Start** screen.
- 3 Click **Scan** (  ).
- 4 Set up the scanning parameters such as image type, document size, and resolution.
- 5 Click **Prescan** (  ) to check the image.
- 6 Adjust the prescanned image with scanning operation functions such as rotate and mirror.

- 7 Click **Scan** (  ) and save the image.



- When you place the originals in the ADF (or DADF), **Prescan** (  ) is not available.
- You can skip step 5, if the Prescan option is selected.



# 6. Troubleshooting

This chapter gives helpful information for what to do if you encounter an error.

- **Paper feeding problems** 282
- **Power and cable connecting problems** 283
- **Printing problems** 284
- **Printing quality problems** 288
- **Copying problems** 296
- **Scanning problems** 297
- **Faxing problems** 299
- **Operating system problems** 301

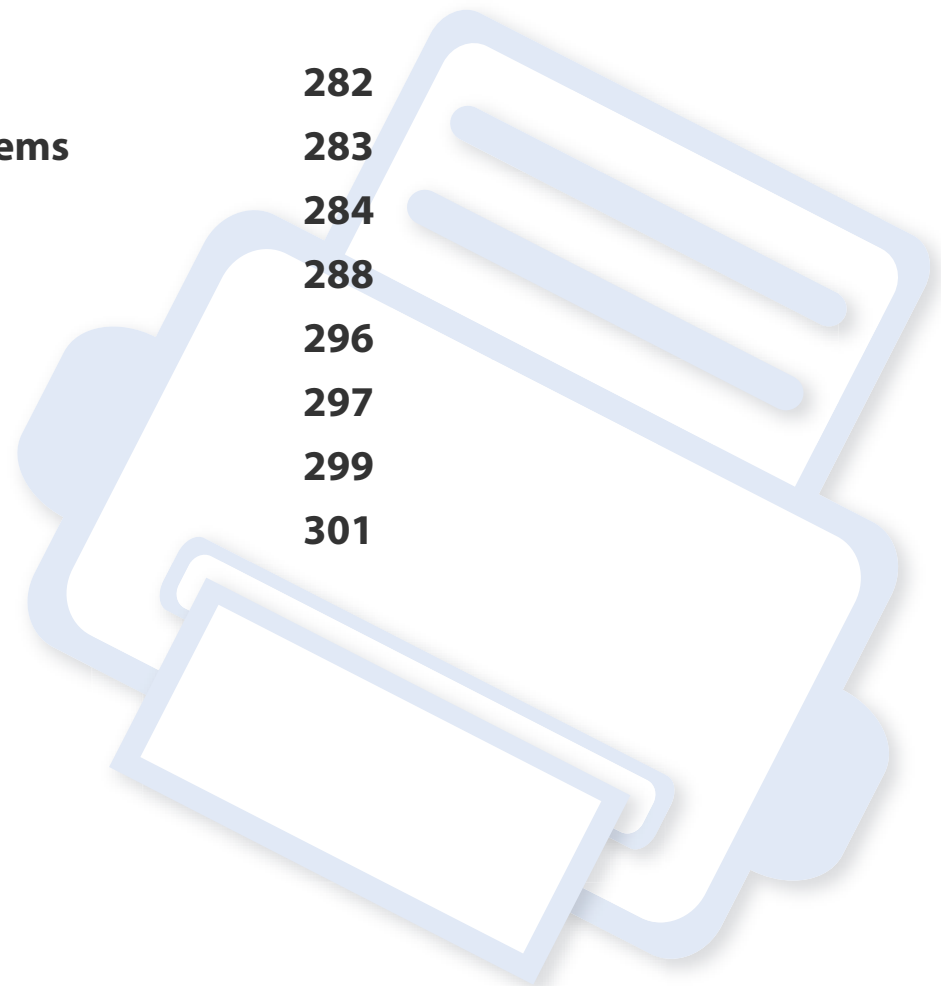

# Paper feeding problems

Condition	Suggested solutions
<b>Paper jams during printing.</b>	Clear the paper jam.
<b>Paper sticks together.</b>	<ul style="list-style-type: none"><li>• Check the maximum paper capacity of the tray.</li><li>• Make sure that you are using the correct type of paper.</li><li>• Remove paper from the tray and flex or fan the paper.</li><li>• Humid conditions may cause some paper to stick together.</li></ul>
<b>Multiple sheets of paper do not feed.</b>	Different types of paper may be stacked in the tray. Load paper of only one type, size, and weight.
<b>Paper does not feed into the machine.</b>	<ul style="list-style-type: none"><li>• Remove any obstructions from inside the machine.</li><li>• Paper has not been loaded correctly. Remove paper from the tray and reload it correctly.</li><li>• There is too much paper in the tray. Remove excess paper from the tray.</li><li>• The paper is too thick. Use only paper that meets the specifications required by the machine.</li></ul>
<b>The paper keeps jamming.</b>	<ul style="list-style-type: none"><li>• There is too much paper in the tray. Remove excess paper from the tray. If you are printing on special materials, use the manual feeding in tray.</li><li>• An incorrect type of paper is being used. Use only paper that meets the specifications required by the machine.</li><li>• There may be debris inside the machine. Open the front cover and remove any debris.</li></ul>
<b>Transparencies stick together in the paper exit.</b>	Use only transparencies specifically designed for laser printers. Remove each transparency as it exits from the machine.
<b>Envelopes skew or fail to feed correctly.</b>	Ensure that the paper guides are against both sides of the envelopes.

# Power and cable connecting problems

Condition	Suggested solutions
<b>The machine is not receiving power, or the connection cable between the computer and the machine is not connected properly.</b>	<ul style="list-style-type: none"><li data-bbox="658 300 2190 384">• Connect the machine to the electricity supply first. If the machine has a  (<b>Power/Wake Up</b>) button on the control, press it.</li><li data-bbox="658 405 1323 437">• Disconnect the machine's cable and reconnect it.</li></ul>

# Printing problems

Condition	Possible cause	Suggested solutions
<b>The machine does not print.</b>	The machine is not receiving power.	Connect the machine to the electricity supply first. If the machine has a  ( <b>Power/Wake Up</b> ) button on the control, press it.
	The machine is not selected as the default machine.	Select your machine as your default machine in Windows.
	Check the machine for the following: <ul style="list-style-type: none"><li>• The cover is not closed. Close the cover.</li><li>• Paper is jammed. Clear the paper jam (see "Clearing paper jams" on page 99).</li><li>• No paper is loaded. Load paper (see "Loading paper in the tray" on page 42).</li><li>• The toner cartridge is not installed. Install the toner cartridge (see "Replacing the toner cartridge" on page 79).</li><li>• Make sure the protect cover and sheets are removed from the toner cartridge (see "Replacing the toner cartridge" on page 79).</li></ul> If a system error occurs, contact your service representative.	
	The connection cable between the computer and the machine is not connected properly.	Disconnect the machine cable and reconnect it (see "Rear view" on page 23).
	The connection cable between the computer and the machine is defective.	If possible, attach the cable to another computer that is working properly and print a job. You can also try using a different machine cable.
	The port setting is incorrect.	Check the Windows printer settings to make sure that the print job is sent to the correct port. If the computer has more than one port, make sure that the machine is attached to the correct one.

# Printing problems

Condition	Possible cause	Suggested solutions
<b>The machine does not print.</b>	The machine may be configured incorrectly.	Check the <b>Printing Preferences</b> to ensure that all of the print settings are correct.
	The printer driver may be incorrectly installed.	Uninstall and reinstall the machine's driver.
	The machine is malfunctioning.	Check the display message on the control panel to see if the machine is indicating a system error. Contact a service representative.
	The document size is so big that the hard disk space of the computer is insufficient to access the print job.	Get more hard disk space and print the document again.
	The output tray is full.	Once the paper is removed from the output tray, the machine resumes printing.
<b>The machine selects print materials from the wrong paper source.</b>	The paper option that was selected in the <b>Printing Preferences</b> may be incorrect.	For many software applications, the paper source selection is found under the <b>Paper</b> tab within the <b>Printing Preferences</b> (see "Opening printing preferences" on page 57). Select the correct paper source. See the printer driver help screen (see "Using help" on page 58).
<b>A print job is extremely slow.</b>	The job may be very complex.	Reduce the complexity of the page or try adjusting the print quality settings.
<b>Half the page is blank.</b>	The page orientation setting may be incorrect.	Change the page orientation in your application (see "Opening printing preferences" on page 57). See the printer driver help screen (see "Using help" on page 58).
	The paper size and the paper size settings do not match.	Ensure that the paper size in the printer driver settings matches the paper in the tray. Or, ensure that the paper size in the printer driver settings matches the paper selection in the software application settings you use (see "Opening printing preferences" on page 57).
<b>The machine prints, but the text is wrong, garbled, or incomplete.</b>	The machine cable is loose or defective.	Disconnect the machine cable and reconnect. Try a print job that you have already printed successfully. If possible, attach the cable and the machine to another computer that you know works and try a print job. Finally, try a new machine cable.

# Printing problems

Condition	Possible cause	Suggested solutions
	The wrong printer driver was selected.	Check the application's printer selection menu to ensure that your machine is selected.
	The software application is malfunctioning.	Try printing a job from another application.
	The operating system is malfunctioning.	Exit Windows and reboot the computer. Turn the machine off and back on again.
<b>Pages print, but they are blank.</b>	The toner cartridge is defective or out of toner.	Redistribute the toner, if necessary. If necessary, replace the toner cartridge. <ul style="list-style-type: none"><li>• See "Redistributing toner" on page 76.</li><li>• See "Replacing the toner cartridge" on page 79.</li></ul>
	The file may have blank pages.	Check the file to ensure that it does not contain blank pages.
	Some parts, such as the controller or the board, may be defective.	Contact a service representative.
<b>The machine does not print PDF files correctly. Some parts of graphics, text, or illustrations are missing.</b>	Incompatibility between the PDF file and the Acrobat products.	Printing the PDF file as an image may enable the file to print. Turn on <b>Print As Image</b> from the Acrobat printing options.   It will take longer to print when you print a PDF file as an image.
<b>The print quality of photos is not good. Images are not clear.</b>	The resolution of the photo is very low.	Reduce the photo size. If you increase the photo size in the software application, the resolution will be reduced.
<b>Before printing, the machine emits vapor near the output tray.</b>	Using damp paper can cause vapor during printing.	This is not a problem. Just keep printing.



# Printing problems

Condition	Possible cause	Suggested solutions
<b>The machine does not print special-sized paper, such as billing paper.</b>	Paper size and paper size setting do not match.	Set the correct paper size in the <b>Custom</b> in <b>Paper</b> tab in <b>Printing Preferences</b> (see "Opening printing preferences" on page 57).
<b>The printed billing paper is curled.</b>	The paper type setting does not match.	Change the printer option and try again. Go to <b>Printing Preferences</b> , click <b>Paper</b> tab, and set type to <b>Thick</b> (see "Opening printing preferences" on page 57).

# Printing quality problems

If the inside of the machine is dirty or paper has been loaded improperly, there might be a reduction in print quality. See the table below to clear the problem.

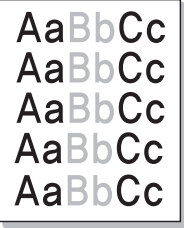
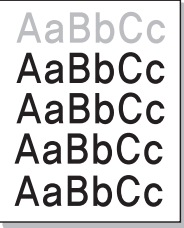
Condition	Suggested solutions
<p data-bbox="49 357 322 389"><b>Light or faded print</b></p> 	<ul data-bbox="506 357 2190 751" style="list-style-type: none"><li>• If a vertical white streak or faded area appears on the page, the toner supply is low. Install a new toner cartridge (see "Replacing the toner cartridge" on page 79).</li><li>• The paper may not meet paper specifications; for example, the paper may be too moist or rough.</li><li>• If the entire page is light, the print resolution setting is too low or the toner save mode is on. Adjust the print resolution and turn the toner save mode off. See the help screen of the printer driver.</li><li>• A combination of faded or smeared defects may indicate that the toner cartridge needs cleaning. Clean the inside of your machine (see "Cleaning the machine" on page 86).</li><li>• The surface of the LSU part inside the machine may be dirty. Clean the inside of your machine (see "Cleaning the machine" on page 86). If these steps do not correct the problem, contact a service representative.</li></ul>
<p data-bbox="49 786 472 903"><b>The top half of the paper is printed lighter than the rest of the paper</b></p> 	<p data-bbox="506 786 1301 818"><b>The toner might not adhere properly to this type of paper.</b></p> <ul data-bbox="506 842 2190 911" style="list-style-type: none"><li>• Change the printer option and try again. Go to <b>Printing Preferences</b>, click the <b>Paper</b> tab, and set the paper type to <b>Recycled</b> (see "Opening printing preferences" on page 57).</li></ul>

# Printing quality problems

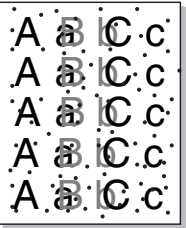
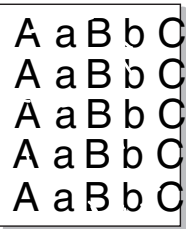
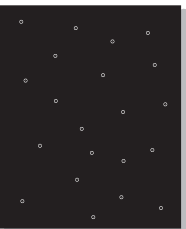
Condition	Suggested solutions
<p><b>Toner specks</b></p> 	<ul style="list-style-type: none"><li>• The paper may not meet specifications; for example, the paper may be too moist or rough.</li><li>• The transfer roller may be dirty. Clean the inside of your machine (see "Cleaning the machine" on page 86).</li><li>• The paper path may need cleaning. Contact a service representative (see "Cleaning the machine" on page 86).</li></ul>
<p><b>Dropouts</b></p> 	<p>If faded areas, generally rounded, occur randomly on the page:</p> <ul style="list-style-type: none"><li>• A single sheet of paper may be defective. Try reprinting the job.</li><li>• The moisture content of the paper is uneven or the paper has moist spots on its surface. Try a different brand of paper.</li><li>• The paper lot is bad. The manufacturing processes can cause some areas to reject toner. Try a different kind or brand of paper.</li><li>• Change the printer option and try again. Go to <b>Printing Preferences</b>, click the <b>Paper</b> tab, and set type to <b>Thick</b> (see "Opening printing preferences" on page 57).</li></ul> <p>If these steps do not correct the problem, contact a service representative.</p>
<p><b>White Spots</b></p> 	<p>If white spots appear on the page:</p> <ul style="list-style-type: none"><li>• The paper is too rough and a lot of dirt from paper falls to the inner components within the machine, so the transfer roller may be dirty. Clean the inside of your machine (see "Cleaning the machine" on page 86).</li><li>• The paper path may need cleaning. Clean the inside of your machine (see "Cleaning the machine" on page 86).</li></ul> <p>If these steps do not correct the problem, contact a service representative.</p>

# Printing quality problems

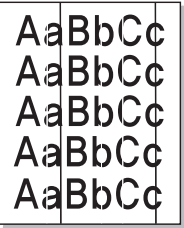
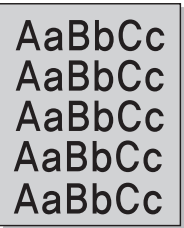
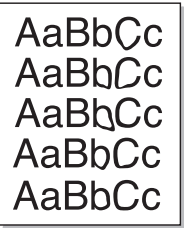
Condition	Suggested solutions
<p><b>Vertical lines</b></p> 	<p>If black vertical streaks appear on the page:</p> <ul style="list-style-type: none"><li>• The surface (drum part) of the cartridge inside the machine has probably been scratched. Remove the cartridge and install a new one (see "Replacing the toner cartridge" on page 79, "Replacing the imaging unit" on page 82).</li></ul> <p>If white vertical streaks appear on the page:</p> <ul style="list-style-type: none"><li>• The surface of the LSU part inside the machine may be dirty. Clean the inside of your machine (see "Cleaning the machine" on page 86). If these steps do not correct the problem, contact a service representative.</li></ul>
<p><b>Black or color background</b></p> 	<p>If the amount of background shading becomes unacceptable:</p> <ul style="list-style-type: none"><li>• Change to a lighter weight paper.</li><li>• Check the environmental conditions: very dry conditions or a high level of humidity (higher than 80% RH) can increase the amount of background shading.</li><li>• Remove the old toner cartridge and install a new one (see "Replacing the toner cartridge" on page 79).</li><li>• Thoroughly redistribute the toner (see "Redistributing toner" on page 76).</li></ul>
<p><b>Toner smear</b></p> 	<ul style="list-style-type: none"><li>• Clean the inside of the machine (see "Cleaning the machine" on page 86).</li><li>• Check the paper type and quality.</li><li>• Remove the toner cartridge and install a new one (see "Replacing the toner cartridge" on page 79).</li></ul>

# Printing quality problems

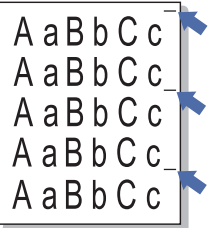
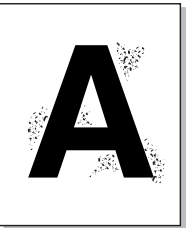
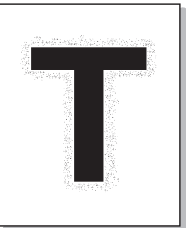
Condition	Suggested solutions
<p data-bbox="49 272 405 304"><b>Vertical repetitive defects</b></p> 	<p data-bbox="504 272 1473 304">If marks repeatedly appear on the printed side of the page at even intervals:</p> <ul data-bbox="504 328 2190 544" style="list-style-type: none"><li data-bbox="504 328 2190 400">• The toner cartridge may be damaged. If you still have the same problem, remove the toner cartridge and, install a new one (see "Replacing the toner cartridge" on page 79).</li><li data-bbox="504 416 2190 488">• Parts of the machine may have toner on them. If the defects occur on the back of the page, the problem will likely correct itself after a few more pages.</li><li data-bbox="504 504 1464 544">• The fusing assembly may be damaged. Contact a service representative.</li></ul>
<p data-bbox="49 612 322 644"><b>Background scatter</b></p> 	<p data-bbox="504 612 1621 644">Background scatter results from bits of toner randomly distributed on the printed page.</p> <ul data-bbox="504 668 2190 1059" style="list-style-type: none"><li data-bbox="504 668 2190 740">• The paper may be too damp. Try printing with a different batch of paper. Do not open packages of paper until necessary so that the paper does not absorb too much moisture.</li><li data-bbox="504 756 2190 876">• If background scatter occurs on an envelope, change the printing layout to avoid printing over areas that have overlapping seams on the reverse side. Printing on seams can cause problems. Or select <b>Thick</b> from the <b>Printing Preferences</b> window (see "Opening printing preferences" on page 57).</li><li data-bbox="504 892 2190 1011">• If background scatter covers the entire surface area of a printed page, adjust the print resolution through your software application or in <b>Printing Preferences</b> (see "Opening printing preferences" on page 57). Ensure the correct paper type is selected. For example: If Thicker Paper is selected, but Plain Paper actually used, an overcharging can occur causing this copy quality problem.</li><li data-bbox="504 1027 1868 1059">• If you are using a new toner cartridge, redistribute the toner first (see "Redistributing toner" on page 76).</li></ul>
<p data-bbox="49 1091 479 1163"><b>Toner particles are around bold characters or pictures</b></p> 	<p data-bbox="504 1091 1249 1123">The toner might not adhere properly to this type of paper.</p> <ul data-bbox="504 1147 2190 1315" style="list-style-type: none"><li data-bbox="504 1147 2190 1219">• Change the printer option and try again. Go to <b>Printing Preferences</b>, click the <b>Paper</b> tab, and set the paper type to <b>Recycled</b> (see "Opening printing preferences" on page 57).</li><li data-bbox="504 1235 2190 1315">• Ensure the correct paper type is selected. For example: If Thicker Paper is selected, but Plain Paper actually used, an overcharging can occur causing this copy quality problem.</li></ul>

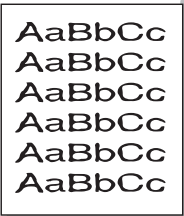
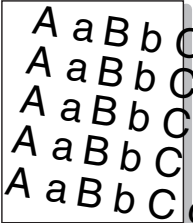
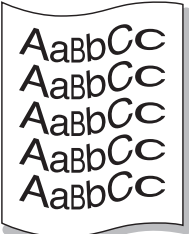

# Printing quality problems

Condition	Suggested solutions
<p data-bbox="49 272 353 304"><b>Misformed characters</b></p> 	<ul data-bbox="506 272 2067 304" style="list-style-type: none"><li>• If characters are improperly formed and producing hollow images, the paper stock may be too slick. Try different paper.</li></ul>
<p data-bbox="49 608 197 639"><b>Page skew</b></p> 	<ul data-bbox="506 608 1518 743" style="list-style-type: none"><li>• Ensure that the paper is loaded properly.</li><li>• Check the paper type and quality.</li><li>• Ensure that the guides are not too tight or too loose against the paper stack.</li></ul>
<p data-bbox="49 951 226 983"><b>Curl or wave</b></p> 	<ul data-bbox="506 951 1727 1086" style="list-style-type: none"><li>• Ensure that the paper is loaded properly.</li><li>• Check the paper type and quality. Both high temperature and humidity can cause paper curl.</li><li>• Turn the stack of paper over in the tray. Also try rotating the paper 180° in the tray.</li></ul>

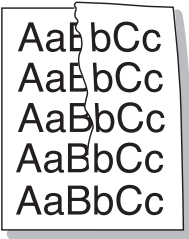
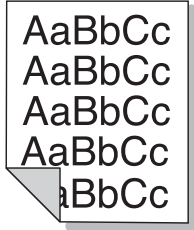
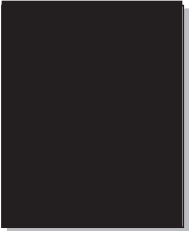
# Printing quality problems

Condition	Suggested solutions
<p data-bbox="49 272 318 300"><b>Wrinkles or creases</b></p> 	<ul data-bbox="504 272 1599 411" style="list-style-type: none"><li>• Ensure that the paper is loaded properly.</li><li>• Check the paper type and quality.</li><li>• Turn the stack of paper over in the tray. Also try rotating the paper 180° in the tray.</li></ul>
<p data-bbox="49 619 412 646"><b>Back of printouts are dirty</b></p> 	<ul data-bbox="504 619 1787 646" style="list-style-type: none"><li>• Check for leaking toner. Clean the inside of the machine (see "Cleaning the machine" on page 86).</li></ul>
<p data-bbox="49 959 405 986"><b>Solid color or black pages</b></p> 	<ul data-bbox="504 959 2159 1129" style="list-style-type: none"><li>• The toner cartridge may not be installed properly. Remove the cartridge and reinsert it.</li><li>• The toner cartridge may be defective. Remove the toner cartridge and install a new one (see "Replacing the toner cartridge" on page 79).</li><li>• The machine may require repairing. Contact a service representative.</li></ul>

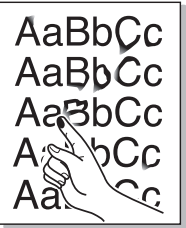
# Printing quality problems

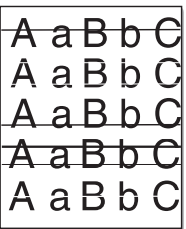
Condition	Suggested solutions
<p><b>Loose toner</b></p> 	<ul style="list-style-type: none"><li>• Clean the inside of the machine (see "Cleaning the machine" on page 86).</li><li>• Check the paper type and quality.</li><li>• Remove the toner cartridge and then, install a new one (see "Replacing the toner cartridge" on page 79).</li></ul> <p>If the problem persists, the machine may require repair. Contact a service representative.</p>
<p><b>Character voids</b></p> 	<p>Character voids are white areas within parts of characters that should be solid black:</p> <ul style="list-style-type: none"><li>• If you are using transparencies, try another type of transparency. Because of the composition of transparencies, some character voids are normal.</li><li>• You may be printing on the wrong surface of the paper. Remove the paper and turn it around.</li><li>• The paper may not meet paper specifications.</li></ul>
<p><b>Horizontal stripes</b></p> 	<p>If horizontally aligned black streaks or smears appear:</p> <ul style="list-style-type: none"><li>• The toner cartridge may be installed improperly. Remove the cartridge and reinsert it.</li><li>• The toner cartridge may be defective. Remove the toner cartridge and install a new one (see "Replacing the toner cartridge" on page 79).</li></ul> <p>If the problem persists, the machine may require repairing. Contact a service representative.</p>

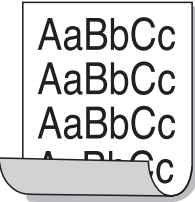

# Printing quality problems

Condition	Suggested solutions
<p><b>Curl</b></p> 	<p>If the printed paper is curled or paper does not feed into the machine:</p> <ul style="list-style-type: none"><li>• Turn the stack of paper over in the tray. Also try rotating the paper 180° in the tray.</li><li>• Change the printer's paper option and try again. Go to <b>Printing Preferences</b>, click the <b>Paper</b> tab, and set type to <b>Thin</b> (see "Opening printing preferences" on page 57).</li></ul>
<ul style="list-style-type: none"><li>• An unknown image repetitively appears on a few sheets</li><li>• Loose toner</li><li>• Light print or contamination occurs</li></ul>	<p>Your machine is probably being used at an altitude of 1,000 m (3,281 ft) or above.</p> <p>The high altitude may affect the print quality, such as loose toner or light imaging. Change the altitude setting for your machine (see "Altitude adjustment" on page 225).</p>

# Copying problems

Condition	Suggested solutions
<b>Copies are too light or too dark.</b>	Adjust the darkness in copy feature to lighten or darken the backgrounds of copies (see "Changing the settings for each copy" on page 62).
<b>If the defect still appears after cleaning the machine.</b>	set the <b>Copy Feature &gt; Adjust Bkgd. &gt; Auto.</b> (see "Menu overview" on page 33).
<b>Smears, lines, marks, or spots appear on copies.</b>	<ul style="list-style-type: none"><li>• If the defects are on the original, adjust darkness in copy feature to lighten the background of your copies.</li><li>• If there are no defects on the original, clean the scan unit (see "Cleaning the scan unit" on page 91).</li></ul>
<b>Copy image is skewed.</b>	<ul style="list-style-type: none"><li>• Ensure that the original is aligned with the registration guide.</li><li>• The transfer roller may be dirty. Clean the inside of your machine (see "Cleaning the machine" on page 86).</li></ul>
<b>Blank copies print out.</b>	Ensure that the original is face down on the scanner glass or face up in the document feeder. If these steps do not correct the problem, contact a service representative.
<b>Image rubs off the copy easily.</b>	<ul style="list-style-type: none"><li>• Replace the paper in the tray with paper from a new package.</li><li>• In high humidity areas, do not leave paper in the machine for extended periods of time.</li></ul>
<b>Frequent copy paper jams occur.</b>	<ul style="list-style-type: none"><li>• Fan the paper, then turn it over in the tray. Replace the paper in the tray with a fresh supply. Check/adjust the paper guides, if necessary.</li><li>• Ensure that the paper is the proper type and weight (see "Print media specifications" on page 118).</li><li>• Check for copy paper or pieces of copy paper remaining in the machine after a paper jam has been cleared.</li></ul>
<b>Toner cartridge produces fewer copies than expected before running out of toner.</b>	<ul style="list-style-type: none"><li>• Your originals may contain pictures, solids, or heavy lines. For example, your originals may be forms, newsletters, books, or other documents that use more toner.</li><li>• The scanner lid may be left open while copies are being made.</li><li>• Turn the machine off and back on.</li></ul>

# Scanning problems

Condition	Suggested solutions
<b>The scanner does not work.</b>	<ul style="list-style-type: none"><li>• Make sure that you place the original to be scanned face down on the scanner glass, or face up in the document feeder (see "Loading originals" on page 52).</li><li>• There may not be enough available memory to hold the document you want to scan. Try the Prescan function to see if that works. Try lowering the scan resolution rate.</li><li>• Check that the machine printer cable is connected properly.</li><li>• Make sure that the machine printer cable is not defective. Switch the printer cable with a known good cable. If necessary, replace the printer cable.</li><li>• Check that the scanner is configured correctly. Check scan setting in the application you want to use to make certain that the scanner job is being sent to the correct port (for example, USB001).</li></ul>
<b>The unit scans very slowly.</b>	<ul style="list-style-type: none"><li>• Check if the machine is printing received data. If so, scan the document after the received data has been printed.</li><li>• Graphics are scanned more slowly than text.</li><li>• Communication speed slows in scan mode because of the large amount of memory required to analyze and reproduce the scanned image. Set your computer to the ECP printer mode through BIOS setting. It will help to increase the speed. For details about how to set BIOS, refer to your computer user's guide.</li></ul>

# Scanning problems

Condition	Suggested solutions
<p><b>Message appears on your computer screen:</b></p> <ul style="list-style-type: none"><li>• Device can't be set to the H/W mode you want.</li><li>• Port is being used by another program.</li><li>• Port is disabled.</li><li>• Scanner is busy receiving or printing data. When the current job is completed, try again.</li><li>• Invalid handle.</li><li>• Scanning has failed.</li></ul>	<ul style="list-style-type: none"><li>• There may be a copying or printing job in progress. Try your job again when that job is finished.</li><li>• The selected port is currently being used. Restart your computer and try again.</li><li>• The machine printer cable may be improperly connected or the power may be off.</li><li>• The scanner driver is not installed or the operating environment is not set up properly.</li><li>• Ensure that the machine is properly connected and the power is on, then restart your computer.</li><li>• The USB cable may be improperly connected or the power may be off.</li></ul>

# Faxing problems

Condition	Suggested solutions
<b>The machine is not working, there is no display, or the buttons are not working.</b>	<ul style="list-style-type: none"><li>• Unplug the power cord and plug it in again.</li><li>• Ensure that there is power being supplied to the electrical outlet.</li><li>• Ensure that the power is turned on.</li></ul>
<b>No dial tone.</b>	<ul style="list-style-type: none"><li>• Check that the phone line is properly connected (see "Rear view" on page 23).</li><li>• Check that the phone socket on the wall is working by plugging in another phone.</li></ul>
<b>The numbers stored in memory do not dial correctly.</b>	Make sure that the numbers are stored in memory correctly. To check that, print an address book list.
<b>The original does not feed into the machine.</b>	<ul style="list-style-type: none"><li>• Make sure that the paper is not wrinkled and you are inserting it in correctly. Check that the original is the right size, not too thick or thin.</li><li>• Make sure that the document feeder is firmly closed.</li><li>• The document feeder rubber pad may need to be replaced. Contact a service representative.</li></ul>
<b>Faxes are not received automatically.</b>	<ul style="list-style-type: none"><li>• The receiving mode should be set to fax (see "Changing the receive modes" on page 257).</li><li>• Make sure that there is paper in the tray (see "Print media specifications" on page 118).</li><li>• Check to see if the display shows any error message. If it does, clear the problem.</li></ul>
<b>The machine does not send.</b>	<ul style="list-style-type: none"><li>• Make sure that the original is loaded in the document feeder or on the scanner glass.</li><li>• Check the fax machine you are sending to, to see if it can receive your fax.</li></ul>
<b>The incoming fax has blank spaces or is of poor-quality.</b>	<ul style="list-style-type: none"><li>• The fax machine sending you the fax may be faulty.</li><li>• A noisy phone line can cause line errors.</li><li>• Check your machine by making a copy.</li><li>• A toner cartridge has almost reached its estimated cartridge life. Replace the toner cartridge (see "Replacing the toner cartridge" on page 79).</li></ul>

# Faxing problems

Condition	Suggested solutions
<b>Some of the words on an incoming fax are stretched.</b>	The fax machine sending the fax had a temporary document jam.
<b>There are lines on the originals you sent.</b>	Check your scan unit for marks and clean it (see "Cleaning the scan unit" on page 91).
<b>The machine dials a number, but the connection with the other fax machine fails.</b>	The other fax machine may be turned off, out of paper, or cannot answer incoming calls. Speak with the other machine operator and ask them to solve the problem on their side.
<b>Faxes do not store in memory.</b>	There may not be enough memory space to store the fax. If the display indicating the memory status shows, delete any faxes you no longer need from the memory, and then try to store the fax again. Call for service.
<b>Blank areas appear at the bottom of each page or on other pages, with a small strip of text at the top.</b>	You may have chosen the wrong paper settings in the user option setting. Check the paper size and type again.

# Operating system problems

## Common Windows problems

Condition	Suggested solutions
<b>“File in Use” message appears during installation.</b>	Exit all software applications. Remove all software from the startup group, then restart Windows. Reinstall the printer driver.
<b>“General Protection Fault”, “Exception OE”, “Spool 32”, or “Illegal Operation” messages appear.</b>	Close all other applications, reboot Windows and try printing again.
<b>“Fail To Print”, “A printer timeout error occurred” message appear.</b>	These messages may appear during printing. Just keep waiting until the machine finishes printing. If the message appears in ready mode or after printing has completed, check the connection and/or whether an error has occurred.
<b>Samsung Printer Experience</b> is not shown when you click <b>more settings</b> .	<b>Samsung Printer Experience</b> is not installed. Download the app. from the Windows <b>Store</b> and install it.
Machine information is not displayed when you click the device in the <b>Devices and Printers</b> .	Check the <b>Printer properties</b> . Click the <b>Ports</b> tab. ( <b>Control Panel</b> > <b>Devices and Printers</b> > Right-click on your printer icon and select <b>Printer properties</b> ) If the port is set to File or LPT, uncheck them and select TCP/IP, USB, or WSD.



Refer to the Microsoft Windows User’s Guide that came with your computer for further information on Windows error messages.

# Operating system problems

## Common Mac problems

Condition	Suggested solutions
<b>The machine does not print PDF files correctly. Some parts of graphics, text, or illustrations are missing.</b>	<p>Printing the PDF file as an image may enable the file to print. Turn on <b>Print As Image</b> from the Acrobat printing options.</p> <p> It will take longer to print when you print a PDF file as an image.</p>
<b>Some letters are not displayed normally during cover page printing.</b>	<p>Mac OS cannot create the font while printing the cover page. The English alphabet and numbers are displayed normally on the cover page.</p>
<b>When printing a document in Mac with Acrobat Reader 6.0 or higher, colors print incorrectly.</b>	<p>Make sure that the resolution setting in your machine driver matches the one in Acrobat Reader.</p>



Refer to the Mac User's Guide that came with your computer for further information on Mac error messages.



# Operating system problems

## Common Linux problems

Condition	Suggested solutions
<b>There is no xsane nor simple-scan application on my Linux machine.</b>	For some Linux distributions, there might be no default scan application. To use scan features, install one of scan applications using download center supplied by the OS(ex. Ubuntu Software Center for Ubuntu, Install/Remove Software for openSUSE, Software for Fedora).
<b>Scanner can not be found via network.</b>	For some Linux distributions, strong firewall is enabled and it may block our installer from opening the necessary port for searching network devices. In such a case, open the snmp port - 22161 manually or disable the firewall temporarily while using the device.
<b>When printing more than one copy, the second copy does not print.</b>	The problem occurs on Ubuntu 12.04 due to the problem in standard CUPS filter 'pdftops'. Update 'cups-filters' package to version 1.0.18 to fix the problem ('pdftops' is a part of 'cups-filters' package).
<b>Unchecking the collate option in the Print Dialog does not work.</b>	For some distributions, GNOME Print Dialog has an issue handling the collate option. As workaround, set the default value of collate option to <b>False</b> using the system's printing utility(execute "system-config-printer" in the Terminal program).
<b>Printing always works with duplex.</b>	This duplex issue was in Ubuntu 9.10 CUPS package. Update CUPS version to 1.4.1-5ubuntu2.2.
<b>Printer is not added through system's printing utility.</b>	The problem occurs on Debian 7 due to the defect in 'system-config-printer' package of the Debian 7 ( <a href="http://bugs.debian.org/cgi-bin/bugreport.cgi?bug=662813">http://bugs.debian.org/cgi-bin/bugreport.cgi?bug=662813</a> in Debian bug tracking system). Please use another way to add printer (CUPS WebUI for example)
<b>Paper size and orientation are disabled in the Print Dialog when opening text files.</b>	The problem occurs on Fedora 19 and it's related to 'leafpad' text editor on Fedora 19. Please use other text editors like 'gedit'.



Refer to the Linux User's Guide that came with your computer for further information on Linux error messages.

# Contact SAMSUNG worldwide

If you have any comments or questions regarding Samsung products, contact the Samsung customer care center.

Country/Region	Customer Care Center	WebSite
<b>ALGERIA</b>	3004 (Toll Free)	www.samsung.com/n_africa/support
<b>ANGOLA</b>	917 267 864	www.samsung.com/support
<b>ARGENTINE</b>	0800-555-SAM(7267)	www.samsung.com/ar
<b>ARMENIA</b>	0-800-05-555	www.samsung.com/support
<b>AUSTRALIA</b>	1300 362 603	www.samsung.com/au/support
<b>AUSTRIA</b>	0800-SAMSUNG (0800-7267864) [Only for Premium HA] 0800-366661 [Only for Dealers] 0810-112233	www.samsung.com/at/support
<b>AZERBAIJAN</b>	0-88-555-55-55	www.samsung.com/support
<b>BAHRAIN</b>	8000-GSAM (8000-4726)	www.samsung.com/ae/support (English) www.samsung.com/ae_ar/support (Arabic)
<b>BANGLADESH</b>	0961-2300300 0800-0300300 (Toll free)	www.samsung.com/in/support

Country/Region	Customer Care Center	WebSite
<b>BELARUS</b>	810-800-500-55-500	www.samsung.com/support
<b>BELGIUM</b>	02-201-24-18	www.samsung.com/be/support (Dutch) www.samsung.com/be_fr/support (French)
<b>BOLIVIA</b>	800-10-7260	www.samsung.com/cl/support
<b>BOSNIA</b>	055 233 999	www.samsung.com/support
<b>BOTSWANA</b>	8007260000	www.samsung.com/support
<b>BRAZIL</b>	0800-124-421 (Demais cidades e regiões) 4004-0000 (Capitais e grandes centros)	www.samsung.com/br/support
<b>BULGARIA</b>	0800 111 31 , Безплатна телефонна линия	www.samsung.com/bg/support
<b>BURUNDI</b>	200	www.samsung.com/support
<b>CAMEROON</b>	7095- 0077	www.samsung.com/africa_fr/support
<b>CANADA</b>	1-800-SAMSUNG (726-7864)	www.samsung.com/ca/support(English) www.samsung.com/ca_fr/support (French)

# Contact SAMSUNG worldwide

Country/Region	Customer Care Center	WebSite
<b>CHILE</b>	800-SAMSUNG (726-7864) [HHP] 02-24828200	www.samsung.com/ cl/support
<b>CHINA</b>	400-810-5858	www.samsung.com/ cn/support
<b>COLOMBIA</b>	Bogotá en el 600 12 72 Sin costo en todo el país 01 8000 112 112 Y desde tu celular #726	www.samsung.com/ co
<b>COSTA RICA</b>	00-800-1-SAMSUNG (726-7864)	www.samsung.com/ latin/support (Spanish) www.samsung.com/ latin_en/support (English)
<b>CROATIA</b>	072 726 786	www.samsung.com/ hr/support
<b>Cote D' Ivoire</b>	8000 0077	www.samsung.com/ africa_fr/support
<b>CYPRUS</b>	8009 4000 only from landline, toll free	www.samsung.com/ gr/support
<b>CZECH</b>	800-SAMSUNG (800-726786)	www.samsung.com/ cz/support
<b>DENMARK</b>	70 70 19 70	www.samsung.com/ dk/support

Country/Region	Customer Care Center	WebSite
<b>DOMINICAN REPUBLIC</b>	1-800-751-2676	www.samsung.com/ latin/support (Spanish) www.samsung.com/ latin_en/support (English)
<b>DRC</b>	4999999	www.samsung.com/ support
<b>ECUADOR</b>	1-800-SAMSUNG (72-6786)	www.samsung.com/ latin/support (Spanish) www.samsung.com/ latin_en/ support(English)
<b>EGYPT</b>	08000-7267864 16580	www.samsung.com/ eg/support
<b>EIRE</b>	0818 717100	www.samsung.com/ ie/support
<b>EL SALVADOR</b>	8000-SAMSUNG (726-7864)	www.samsung.com/ latin/support (Spanish) www.samsung.com/ latin_en/support (English)
<b>ESTONIA</b>	800-7267	www.samsung.com/ ee/support

# Contact SAMSUNG worldwide

Country/Region	Customer Care Center	WebSite
<b>FINLAND</b>	030-6227 515	<a href="http://www.samsung.com/fi/support">www.samsung.com/fi/support</a>
<b>FRANCE</b>	01 48 63 00 00	<a href="http://www.samsung.com/fr/support">www.samsung.com/fr/support</a>
<b>GERMANY</b>	0180 6 SAMSUNG bzw. 0180 6 7267864* (*0,20 €/Anruf aus dem dt. Festnetz, aus dem Mobilfunk max. 0,60 €/Anruf) [HHP] 0180 6 M SAMSUNG bzw. 0180 6 67267864* (*0,20 €/Anruf aus dem dt. Festnetz, aus dem Mobilfunk max. 0,60 €/Anruf)	<a href="http://www.samsung.com/de/support">www.samsung.com/de/support</a>
<b>GEORGIA</b>	0-800-555-555	<a href="http://www.samsung.com/support">www.samsung.com/support</a>
<b>GHANA</b>	0800-10077 0302-200077	<a href="http://www.samsung.com/africa_en/support">www.samsung.com/africa_en/support</a>
<b>GREECE</b>	80111-SAMSUNG (80111 726 7864) only from land line (+30) 210 6897691 from mobile and land line	<a href="http://www.samsung.com/gr/support">www.samsung.com/gr/support</a>

Country/Region	Customer Care Center	WebSite
<b>GUATEMALA</b>	1-800-299-0033	<a href="http://www.samsung.com/latin/support">www.samsung.com/latin/support</a> (Spanish) <a href="http://www.samsung.com/latin_en/support">www.samsung.com/latin_en/support</a> (English)
<b>HONDURAS</b>	800-2791-9111	<a href="http://www.samsung.com/latin/support">www.samsung.com/latin/support</a> (Spanish) <a href="http://www.samsung.com/latin_en/support">www.samsung.com/latin_en/support</a> (English)
<b>HONG KONG</b>	3698 4698	<a href="http://www.samsung.com/hk/support">www.samsung.com/hk/support</a> (Chinese) <a href="http://www.samsung.com/hk_en/support">www.samsung.com/hk_en/support</a> (English)
<b>HUNGARY</b>	0680SAMSUNG (0680-726-786) 0680PREMIUM (0680-773-648)	<a href="http://www.samsung.com/hu/support">www.samsung.com/hu/support</a>
<b>INDIA</b>	1800 3000 8282 - Toll Free 1800 266 8282 - Toll Free	<a href="http://www.samsung.com/in/support">www.samsung.com/in/support</a>
<b>INDONESIA</b>	021-56997777 08001128888	<a href="http://www.samsung.com/id/support">www.samsung.com/id/support</a>
<b>IRAN</b>	021-8255 [CE] 021-42132 [HHP]	<a href="http://www.samsung.com/iran/support">www.samsung.com/iran/support</a>

# Contact SAMSUNG worldwide

Country/Region	Customer Care Center	WebSite
<b>ITALIA</b>	800-SAMSUNG (800.7267864)	www.samsung.com/it/support
<b>JAMAICA</b>	1-800-SAMSUNG (726-7864)	www.samsung.com/latin_en/support (English)
<b>JAPAN</b>	0120-363-905	www.samsung.com/jp/support
<b>JORDAN</b>	0800-22273 06 5777444	www.samsung.com/Levant
<b>KAZAKHSTAN</b>	8-10-800-500-55-500 (GSM: 7799, VIP care 7700)	www.samsung.com/kz_ru/support
<b>KENYA</b>	0800 545 545	www.samsung.com/support
<b>KUWAIT</b>	183-CALL (183-2255)	www.samsung.com/ae/support (English) www.samsung.com/ae_ar/support (Arabic)
<b>KYRGYZSTAN</b>	00-800-500-55-500 (GSM: 9977)	www.samsung.com/support
<b>LATVIA</b>	8000-7267	www.samsung.com/lv/support
<b>LEBANON</b>	961 1484 999	www.samsung.com/Levant
<b>LITHUANIA</b>	8-800-77777	www.samsung.com/lt/support

Country/Region	Customer Care Center	WebSite
<b>LUXEMBURG</b>	261 03 710	www.samsung.com/be_fr/support
<b>MACAU</b>	0800 333	www.samsung.com/support
<b>MACEDONIA</b>	023 207 777	
<b>MALAYSIA</b>	1800-88-9999 603-77137477 (Overseas contact)	www.samsung.com/my/support
<b>MAURITIUS</b>	800 2550	www.samsung.com/support
<b>MEXICO</b>	01-800-SAMSUNG (726-7864)	www.samsung.com/mx/support
<b>MOLDOVA</b>	0-800-614-40	www.samsung.com/support
<b>MONGOLIA</b>	+7-495-363-17-00	www.samsung.com/support
<b>MONTENEGRO</b>	020 405 888	www.samsung.com/support
<b>MOROCCO</b>	080 100 22 55	www.samsung.com/n_africa/support
<b>MOZAMBIQUE</b>	847267864 / 827267864	www.samsung.com/support
<b>MYANMAR</b>	+95-01-2399-888	www.samsung.com/support
<b>NAMIBIA</b>	08 197 267 864	www.samsung.com/support

# Contact SAMSUNG worldwide

Country/Region	Customer Care Center	WebSite
<b>NIGERIA</b>	0800-726-7864	www.samsung.com/ africa_en/support
<b>NETHERLANDS</b>	0900-SAMSUNG (0900-7267864) (€ 0,10/Min)	www.samsung.com/ nl/support
<b>NEW ZEALAND</b>	0800 726 786	www.samsung.com/ nz/support
<b>NICARAGUA</b>	001-800-5077267	www.samsung.com/ latin/support(Spanish)  www.samsung.com/ latin_en/support (English)
<b>NORWAY</b>	815 56480	www.samsung.com/ no/support
<b>OMAN</b>	800-SAMSUNG (800 - 726 7864)	www.samsung.com/ ae/support (English) www.samsung.com/ ae_ar/support (Arabic)
<b>PAKISTAN</b>	0800-Samsung (72678)	www.samsung.com/ pk/support
<b>PANAMA</b>	800-0101	www.samsung.com/ latin/support (Spanish)  www.samsung.com/ latin_en/support (English)
<b>PARAGUAY</b>	0800-11-SAMS(7267)	www.samsung.com/ar

Country/Region	Customer Care Center	WebSite
<b>PERU</b>	0800-777-08	www.samsung.com/ pe/support
<b>PHILIPPINES</b>	1-800-10-726-7864 [ PLDT Toll Free ]  1-800-8-726-7864 [ Globe Landline and Mobile ]  02- 422-2111 [ Standard Landline ]	www.samsung.com/ ph/support
<b>POLAND</b>	801-172-678* lub +48 22 607-93- 33*  Dedykowana infolinia do obsługi zapytań dotyczących telefonów komórkowych: 801-672-678* lub +48 22 607-93-33*  * (koszt połączenia według taryfy operatora)	www.samsung.com/ pl/support
<b>PORTUGAL</b>	808 20 7267	www.samsung.com/ pt/support
<b>PUERTO RICO</b>	1-800-682-3180	www.samsung.com/ latin/support (Spanish)  www.samsung.com/ latin_en/support (English)

# Contact SAMSUNG worldwide

Country/Region	Customer Care Center	WebSite
<b>QATAR</b>	800-CALL (800-2255)	www.samsung.com/ ae/support (English) www.samsung.com/ ae_ar/support (Arabic)
<b>REUNION</b>	0262 50 88 80	www.samsung.com/ support
<b>RWANDA</b>	9999	www.samsung.com/ support
<b>ROMANIA</b>	*8000 (apel in retea) 08008-726-78-64 (08008- SAMSUNG) Apel GRATUIT	www.samsung.com/ ro/support
<b>RUSSIA</b>	8-800-555-55-55 (VIP care 8-800- 555-55-88)	www.samsung.com/ ru/support
<b>SAUDI ARABIA</b>	800 247 3457 (800 24/7 HELP)	www.samsung.com/ sa/home www.samsung.com/ sa_en
<b>SENEGAL</b>	800-00-0077	www.samsung.com/ africa_fr/support
<b>SERBIA</b>	011 321 6899	www.samsung.com/ rs/support
<b>SINGAPORE</b>	1800-SAMSUNG (726-7864)	www.samsung.com/ sg/support
<b>SLOVENIA</b>	080 697 267 (brezplačna številka)	www.samsung.com/si

Country/Region	Customer Care Center	WebSite
<b>SLOVAKIA</b>	0800 - SAMSUNG (0800-726 786)	www.samsung.com/ sk/support
<b>SOUTH AFRICA</b>	0860 SAMSUNG (726 7864)	www.samsung.com/ support
<b>SPAIN</b>	0034902172678 [HHP] 0034902167267	www.samsung.com/ es/support
<b>SRI LANKA</b>	0117540540 0115900000	www.samsung.com/ support
<b>SUDAN</b>	1969	www.samsung.com/ support
<b>SWEDEN</b>	0771 726 7864 (0771-SAMSUNG)	www.samsung.com/ se/support
<b>SWITZERLAND</b>	0800 726 78 64 (0800-SAMSUNG)	www.samsung.com/ ch/support (German) www.samsung.com/ ch_fr/support (French)
<b>SYRIA</b>	18252273	www.samsung.com/ Levant
<b>TAJIKISTAN</b>	8-10-800-500-55-500	www.samsung.com/ support
<b>TAIWAN</b>	0800-329999	www.samsung.com/ tw/support
<b>TANZANIA</b>	0800 755 755 0685 889 900	www.samsung.com/ support

# Contact SAMSUNG worldwide

Country/Region	Customer Care Center	WebSite
<b>THAILAND</b>	0-2689-3232, 1800-29-3232	www.samsung.com/ th/support
<b>TRINIDAD &amp; TOBAGO</b>	1-800-SAMSUNG (726-7864)	www.samsung.com/ latin/support (Spanish)  www.samsung.com/ latin_en/support (English)
<b>TURKEY</b>	444 77 11	www.samsung.com/ tr/support
<b>TUNISIA</b>	80-1000-12	www.samsung.com/ n_africa/support
<b>U.A.E</b>	800-SAMSUNG (800 -726 7864)	www.samsung.com/ ae/support (English)  www.samsung.com/ ae_ar/support (Arabic)
<b>UK</b>	0330 SAMSUNG (7267864)	www.samsung.com/ uk/support
<b>U.S.A -Consumer Electronics</b>	1-800-SAMSUNG (726-7864)	www.samsung.com/ us/support
<b>U.S.A -(Mobile Phones)</b>	1-800-SAMSUNG (726-7864)	www.samsung.com/ us/support
<b>UGANDA</b>	0800 300 300	www.samsung.com/ support

Country/Region	Customer Care Center	WebSite
<b>UKRAINE</b>	0-800-502-000	www.samsung.com/ ua/support (Ukrainian)  www.samsung.com/ ua_ru/support (Russian)
<b>URUGUAY</b>	0800-SAMS(7267)	www.samsung.com/ar
<b>UZBEKISTAN</b>	00-800-500-55-500 (GSM: 7799)	www.samsung.com/ support
<b>VENEZUELA</b>	0-800-SAMSUNG (726-7864)	www.samsung.com/ ve/support
<b>VIETNAM</b>	1800 588 889	www.samsung.com/ vn/support
<b>ZAMBIA</b>	0211 350370	www.samsung.com/ support





The following glossary helps you get familiar with the product by understanding the terminologies commonly used with printing as well as mentioned in this user's guide.

## 802.11

---

802.11 is a set of standards for wireless local area network (WLAN) communication, developed by the IEEE LAN/MAN Standards Committee (IEEE 802).

## 802.11b/g/n

---

802.11b/g/n can share same hardware and use the 2.4 GHz band. 802.11b supports bandwidth up to 11 Mbps, 802.11n supports bandwidth up to 150 Mbps. 802.11b/g/n devices may occasionally suffer interference from microwave ovens, cordless telephones, and Bluetooth devices.

## Access point

---

Access Point or Wireless Access Point (AP or WAP) is a device that connects wireless communication devices together on wireless local area networks (WLAN), and acts as a central transmitter and receiver of WLAN radio signals.

## ADF

---

An Automatic Document Feeder (ADF) is a scanning unit that will automatically feed an original sheet of paper so that the machine can scan some amount of the paper at once.

## AppleTalk

---

AppleTalk is a proprietary suite of protocols developed by Apple, Inc for computer networking. It was included in the original Mac (1984) and is now deprecated by Apple in favor of TCP/IP networking.

## BIT Depth

---

A computer graphics term describing the number of bits used to represent the color of a single pixel in a bitmapped image. Higher color depth gives a broader range of distinct colors. As the number of bits increases, the number of possible colors becomes impractically large for a color map. 1-bit color is commonly called as monochrome or black and white.

## BMP

---

A bitmapped graphics format used internally by the Microsoft Windows graphics subsystem (GDI), and used commonly as a simple graphics file format on that platform.

## BOOTP

---

Bootstrap Protocol. A network protocol used by a network client to obtain its IP address automatically. This is usually done in the bootstrap process of computers or operating systems running on them. The BOOTP servers assign the IP address from a pool of addresses to each client. BOOTP enables 'diskless workstation' computers to obtain an IP address prior to loading any advanced operating system.

## CCD

---

Charge Coupled Device (CCD) is a hardware which enables the scan job. CCD Locking mechanism is also used to hold the CCD module to prevent any damage when you move the machine.

## Collation

---

Collation is a process of printing a multiple-copy job in sets. When collation is selected, the device prints an entire set before printing additional copies.

## Control Panel

---

A control panel is a flat, typically vertical, area where control or monitoring instruments are displayed. They are typically found in front of the machine.

## Coverage

---

It is the printing term used for a toner usage measurement on printing. For example, 5% coverage means that an A4 sided paper has about 5% image or text on it. So, if the paper or original has complicated images or lots of text on it, the coverage will be higher and at the same time, a toner usage will be as much as the coverage.

## CSV

---

Comma Separated Values (CSV). A type of file format, CSV is used to exchange data between disparate applications. The file format, as it is used in Microsoft Excel, has become a de facto standard throughout the industry, even among non-Microsoft platforms.

## DADF

---

A Duplex Automatic Document Feeder (DADF) is a scanning unit that will automatically feed and turn over an original sheet of paper so that the machine can scan on both sides of the paper.

## Default

---

The value or setting that is in effect when taking a printer out of its box state, reset, or initialized.

## DHCP

---

A Dynamic Host Configuration Protocol (DHCP) is a client-server networking protocol. A DHCP server provides configuration parameters specific to the DHCP client host requesting, generally, information required by the client host to participate on an IP network. DHCP also provides a mechanism for allocation of IP addresses to client hosts.

## DIMM

---

Dual Inline Memory Module (DIMM), a small circuit board that holds memory. DIMM stores all the data within the machine like printing data, received fax data.

## DLNA

---

The Digital Living Network Alliance (DLNA) is a standard that allows devices on a home network to share information with each other across the network.

## DNS

---

The Domain Name Server (DNS) is a system that stores information associated with domain names in a distributed database on networks, such as the Internet.

## Dot Matrix Printer

---

A dot matrix printer refers to a type of computer printer with a print head that runs back and forth on the page and prints by impact, striking an ink-soaked cloth ribbon against the paper, much like a typewriter.

## DPI

---

Dots Per Inch (DPI) is a measurement of resolution that is used for scanning and printing. Generally, higher DPI results in a higher resolution, more visible detail in the image, and a larger file size.

## DRPD

---

Distinctive Ring Pattern Detection. Distinctive Ring is a telephone company service which enables a user to use a single telephone line to answer several different telephone numbers.

## Duplex

---

A mechanism that will automatically turn over a sheet of paper so that the machine can print (or scan) on both sides of the paper. A printer equipped with a Duplex Unit can print on both sides of paper during one print cycle.

## Duty Cycle

---

Duty cycle is the page quantity which does not affect printer performance for a month. Generally the printer has the lifespan limitation such as pages per year. The lifespan means the average capacity of print-outs, usually within the warranty period. For example, if the duty cycle is 48,000 pages per month assuming 20 working days, a printer limits 2,400 pages a day.

## ECM

---

Error Correction Mode (ECM) is an optional transmission mode built into Class 1 fax machines or fax modems. It automatically detects and corrects errors in the fax transmission process that are sometimes caused by telephone line noise.

## Emulation

---

Emulation is a technique of one machine obtaining the same results as another.

An emulator duplicates the functions of one system with a different system, so that the second system behaves like the first system. Emulation focuses on exact reproduction of external behavior, which is in contrast to simulation, which concerns an abstract model of the system being simulated, often considering its internal state.

## Ethernet

---

Ethernet is a frame-based computer networking technology for local area networks (LANs). It defines wiring and signaling for the physical layer, and frame formats and protocols for the media access control (MAC)/data link layer of the OSI model. Ethernet is mostly standardized as IEEE 802.3. It has become the most widespread LAN technology in use during the 1990s to the present.

## EtherTalk

---

A suite of protocols developed by Apple Computer for computer networking. It was included in the original Mac (1984) and is now deprecated by Apple in favor of TCP/IP networking.

## FDI

---

Foreign Device Interface (FDI) is a card installed inside the machine to allow a third party device such as a coin operated device or a card reader. Those devices allow the pay-for-print service on your machine.

## FTP

---

A File Transfer Protocol (FTP) is a commonly used protocol for exchanging files over any network that supports the TCP/IP protocol (such as the Internet or an intranet).

## Fuser Unit

---

The part of a laser printer that fuses the toner onto the print media. It consists of a heat roller and a pressure roller. After toner is transferred onto the paper, the fuser unit applies heat and pressure to ensure that the toner stays on the paper permanently, which is why paper is warm when it comes out of a laser printer.

## Gateway

---

A connection between computer networks, or between a computer network and a telephone line. It is very popular, as it is a computer or a network that allows access to another computer or network.

## Grayscale

---

A shades of gray that represents light and dark portions of an image when color images are converted to grayscale; colors are represented by various shades of gray.

## Halftone

---

An image type that simulates grayscale by varying the number of dots. Highly colored areas consist of a large number of dots, while lighter areas consist of a smaller number of dots.

## Mass storage device (HDD)

---

Mass storage device (HDD), commonly referred to as a hard drive or hard disk, is a non-volatile storage device which stores digitally-encoded data on rapidly rotating platters with magnetic surfaces.

## IEEE

---

The Institute of Electrical and Electronics Engineers (IEEE) is an international non-profit, professional organization for the advancement of technology related to electricity.

## IEEE 1284

---

The 1284 parallel port standard was developed by the Institute of Electrical and Electronics Engineers (IEEE). The term "1284-B" refers to a specific connector type on the end of the parallel cable that attaches to the peripheral (for example, a printer).

## Intranet

---

A private network that uses Internet Protocols, network connectivity, and possibly the public telecommunication system to securely share part of an organization's information or operations with its employees. Sometimes the term refers only to the most visible service, the internal website.

## IP address

---

An Internet Protocol (IP) address is a unique number that devices use in order to identify and communicate with each other on a network utilizing the Internet Protocol standard.

## IPM

---

The Images Per Minute (IPM) is a way of measuring the speed of a printer. An IPM rate indicates the number of single-sided sheets a printer can complete within one minute.

## IPP

---

The Internet Printing Protocol (IPP) defines a standard protocol for printing as well as managing print jobs, media size, resolution, and so forth. IPP can be used locally or over the Internet to hundreds of printers, and also supports access control, authentication, and encryption, making it a much more capable and secure printing solution than older ones.

## IPX/SPX

---

IPX/SPX stands for Internet Packet Exchange/Sequenced Packet Exchange. It is a networking protocol used by the Novell NetWare operating systems. IPX and SPX both provide connection services similar to TCP/IP, with the IPX protocol having similarities to IP, and SPX having similarities to TCP. IPX/SPX was primarily designed for local area networks (LANs), and is a very efficient protocol for this purpose (typically its performance exceeds that of TCP/IP on a LAN).

## ISO

---

The International Organization for Standardization (ISO) is an international standard-setting body composed of representatives from national standards bodies. It produces world-wide industrial and commercial standards.

## ITU-T

---

The International Telecommunication Union is an international organization established to standardize and regulate international radio and telecommunications. Its main tasks include standardization, allocation of the radio spectrum, and organizing interconnection arrangements between different countries to allow international phone calls. A -T out of ITU-T indicates telecommunication.

## ITU-T No. 1 chart

---

Standardized test chart published by ITU-T for document facsimile transmissions.

## JBIG

---

Joint Bi-level Image Experts Group (JBIG) is an image compression standard with no loss of accuracy or quality, which was designed for compression of binary images, particularly for faxes, but can also be used on other images.

## JPEG

---

Joint Photographic Experts Group (JPEG) is a most commonly used standard method of lossy compression for photographic images. It is the format used for storing and transmitting photographs on the World Wide Web.

## LDAP

---

The Lightweight Directory Access Protocol (LDAP) is a networking protocol for querying and modifying directory services running over TCP/IP.

## LED

---

A Light-Emitting Diode (LED) is a semiconductor device that indicates the status of a machine.

## MAC address

---

Media Access Control (MAC) address is a unique identifier associated with a network adapter. MAC address is a unique 48-bit identifier usually written as 12 hexadecimal characters grouped in pairs (e. g., 00-00-0c-34-11-4e). This address is usually hard-coded into a Network Interface Card (NIC) by its manufacturer, and used as an aid for routers trying to locate machines on large networks.

## MFP

---

Multi Function Peripheral (MFP) is an office machine that includes the following functionality in one physical body, so as to have a printer, a copier, a fax, a scanner and etc.

## MH

---

Modified Huffman (MH) is a compression method for decreasing the amount of data that needs to be transmitted between the fax machines to transfer the image recommended by ITU-T T.4. MH is a codebook-based run-length encoding scheme optimized to efficiently compress white space. As most faxes consist mostly of white space, this minimizes the transmission time of most faxes.

## MMR

---

Modified Modified READ (MMR) is a compression method recommended by ITU-T T.6.

## Modem

---

A device that modulates a carrier signal to encode digital information, and also demodulates such a carrier signal to decode transmitted information.

## MR

---

Modified Read (MR) is a compression method recommended by ITU-T T.4. MR encodes the first scanned line using MH. The next line is compared to the first, the differences determined, and then the differences are encoded and transmitted.

# Glossary

## NetWare

---

A network operating system developed by Novell, Inc. It initially used cooperative multitasking to run various services on a PC, and the network protocols were based on the archetypal Xerox XNS stack. Today NetWare supports TCP/IP as well as IPX/SPX.

## OPC

---

Organic Photo Conductor (OPC) is a mechanism that makes a virtual image for print using a laser beam emitted from a laser printer, and it is usually green or rust colored and has a cylinder shape.

An imaging unit containing a drum slowly wears the drum surface by its usage in the printer, and it should be replaced appropriately since it gets worn from contact with the cartridge development brush, cleaning mechanism, and paper.

## Originals

---

The first example of something, such as a document, photograph or text, etc, which is copied, reproduced or translated to produce others, but which is not itself copied or derived from something else.

## OSI

---

Open Systems Interconnection (OSI) is a model developed by the International Organization for Standardization (ISO) for communications. OSI offers a standard, modular approach to network design that divides the required set of complex functions into manageable, self-contained, functional layers. The layers are, from top to bottom, Application, Presentation, Session, Transport, Network, Data Link and Physical.

## PABX

---

A private automatic branch exchange (PABX) is an automatic telephone switching system within a private enterprise.

## PCL

---

Printer Command Language (PCL) is a Page Description Language (PDL) developed by HP as a printer protocol and has become an industry standard. Originally developed for early inkjet printers, PCL has been released in varying levels for thermal, dot matrix printer, and laser printers.

## PDF

---

Portable Document Format (PDF) is a proprietary file format developed by Adobe Systems for representing two dimensional documents in a device independent and resolution independent format.



## PostScript

---

PostScript (PS) is a page description language and programming language used primarily in the electronic and desktop publishing areas. - that is run in an interpreter to generate an image.

## Printer Driver

---

A program used to send commands and transfer data from the computer to the printer.

## Print Media

---

The media like paper, envelopes, labels, and transparencies which can be used in a printer, a scanner, a fax or, a copier.

## PPM

---

Pages Per Minute (PPM) is a method of measurement for determining how fast a printer works, meaning the number of pages a printer can produce in one minute.

## PRN file

---

An interface for a device driver, this allows software to interact with the device driver using standard input/output system calls, which simplifies many tasks.

## Protocol

---

A convention or standard that controls or enables the connection, communication, and data transfer between two computing endpoints.

## PS

---

See PostScript.

## PSTN

---

The Public-Switched Telephone Network (PSTN) is the network of the world's public circuit-switched telephone networks which, on industrial premises, is usually routed through the switchboard.

## RADIUS

---

Remote Authentication Dial In User Service (RADIUS) is a protocol for remote user authentication and accounting. RADIUS enables centralized management of authentication data such as usernames and passwords using an AAA (authentication, authorization, and accounting) concept to manage network access.

## Resolution

---

The sharpness of an image, measured in Dots Per Inch (DPI). The higher the dpi, the greater the resolution.

## SMB

---

Server Message Block (SMB) is a network protocol mainly applied to share files, printers, serial ports, and miscellaneous communications between nodes on a network. It also provides an authenticated Inter-process communication mechanism.

## SMTP

---

Simple Mail Transfer Protocol (SMTP) is the standard for e-mail transmissions across the Internet. SMTP is a relatively simple, text-based protocol, where one or more recipients of a message are specified, and then the message text is transferred. It is a client-server protocol, where the client transmits an email message to the server.

## SSID

---

Service Set Identifier (SSID) is a name of a wireless local area network (WLAN). All wireless devices in a WLAN use the same SSID in order to communicate with each other. The SSIDs are case-sensitive and have a maximum length of 32 characters.

## Subnet Mask

---

The subnet mask is used in conjunction with the network address to determine which part of the address is the network address and which part is the host address.

## TCP/IP

---

The Transmission Control Protocol (TCP) and the Internet Protocol (IP); the set of communications protocols that implement the protocol stack on which the Internet and most commercial networks run.

## TCR

---

Transmission Confirmation Report (TCR) provides details of each transmission such as job status, transmission result and number of pages sent. This report can be set to print after each job or only after failed transmissions.

## TIFF

---

Tagged Image File Format (TIFF) is a variable-resolution bitmapped image format. TIFF describes image data that typically come from scanners. TIFF images make use of tags, keywords defining the characteristics of the image that is included in the file. This flexible and platform-independent format can be used for pictures that have been made by various image processing applications.

## Toner Cartridge

---

A kind of bottle or container used in a machine like a printer which contains toner. Toner is a powder used in laser printers and photocopiers, which forms the text and images on the printed paper. Toner can be fused by a combination of heat/pressure from the fuser, causing it to bind to the fibers in the paper.

## TWAIN

---

An industry standard for scanners and software. By using a TWAIN-compliant scanner with a TWAIN-compliant program, a scan can be initiated from within the program. It is an image capture API for Microsoft Windows and Apple Mac operating systems.

## UNC Path

---

Uniform Naming Convention (UNC) is a standard way to access network shares in Window NT and other Microsoft products. The format of a UNC path is:  
\\<servername>\<sharename>\<Additional directory>

## URL

---

Uniform Resource Locator (URL) is the global address of documents and resources on the Internet. The first part of the address indicates what protocol to use, the second part specifies the IP address or the domain name where the resource is located.

## USB

---

Universal Serial Bus (USB) is a standard that was developed by the USB Implementers Forum, Inc., to connect computers and peripherals. Unlike the parallel port, USB is designed to concurrently connect a single computer USB port to multiple peripherals.

## Watermark

---

A watermark is a recognizable image or pattern in paper that appears lighter when viewed by transmitted light. Watermarks were first introduced in Bologna, Italy in 1282; they have been used by papermakers to identify their product, and also on postage stamps, currency, and other government documents to discourage counterfeiting.

## WEP

---

Wired Equivalent Privacy (WEP) is a security protocol specified in IEEE 802.11 to provide the same level of security as that of a wired LAN. WEP provides security by encrypting data over radio so that it is protected as it is transmitted from one end point to another.

## WIA

---

Windows Imaging Architecture (WIA) is an imaging architecture that is originally introduced in Windows Me and Windows XP. A scan can be initiated from within these operating systems by using a WIA-compliant scanner.

## WPA

---

Wi-Fi Protected Access (WPA) is a class of systems to secure wireless (Wi-Fi) computer networks, which was created to improve upon the security features of WEP.

## WPA-PSK

---

WPA-PSK (WPA Pre-Shared Key) is special mode of WPA for small business or home users. A shared key, or password, is configured in the wireless access point (WAP) and any wireless laptop or desktop devices. WPA-PSK generates a unique key for each session between a wireless client and the associated WAP for more advanced security.

## WPS

---

The Wi-Fi Protected Setup (WPS) is a standard for establishing a wireless home network. If your wireless access point supports WPS, you can configure the wireless network connection easily without a computer.

## XPS

---

XML Paper Specification (XPS) is a specification for a Page Description Language (PDL) and a new document format, which has benefits for portable document and electronic document, developed by Microsoft. It is an XML-based specification, based on a new print path and a vector-based device-independent document format.

# Index

## A

---

address book	
editing	228
group editing	229
registering	228
using	228
address book setup	228
AirPrint	203
AnyWeb Print	264

## B

---

buttons	
print screen	27

## C

---

cleaning	
inside	87
outside	86
pickup roller	89
scan unit	91
cleaning a machine	86
control panel	24
convention	14
copy	

general setup	211
copying	
basic copying	60
reducing or enlarging copies	62

## D

---

default settings	
tray setting	49
direct printing utility	238
driver installation	
Unix	159

## E

---

easy document creator	269
e-book conversion	269
eco printing	57
entering character	226
error message	110

## F

---

favorites settings, for printing	56
fax	
adding documents to a reserved fax	254, 252

canceling a reserved fax job	254, 257
delaying a fax transmission	253
forwarding a received fax to another destination	256, 255
general setup	214
printing faxes on both sides of the paper	259
Printing sent fax report automatically	260
receiving faxes in memory	260, 257, 258, 257, 259, 257, 258, 252
sending a fax in the computer	253, 255

fax feature	252
-------------	-----

fax sending	
multi sending	67

faxing	
adjusting darkness	69, 68
preparing to fax	66
receiving in Fax mode	68

features	5
machine features	208
print media feature	118

front view	22
------------	----

## G

---

general icons	14
---------------	----

# Index

general settings	217	linux scanning	251	multi-purpose tray	
glossary	312	loading		tips on using	42
google cloud printing	205	paper in manual feeder/multi-purpose tray	41	using special media	44
<b>I</b>		special media	44	<b>N</b>	
id copy	63	loading originals	51	network	
ID copy button	24, 25	<b>M</b>		driver installation	
<b>J</b>		Mac		Linux	158
jam		common Mac problems	302	Mac	157
clearing original document	96, 99	driver installation for network connected	144, 145	UNIX	159
tips for avoiding paper jams	95	printing	239	Windows	153
<b>L</b>		scanning	250, 122	general setup	222
LCD display		using SetIP	151	installing environment	125, 149
browsing the machine status	211, 213, 214, 221	mac		IPv6 configuration	162
Linux		scanning	250	SetIP program	150, 151, 152, 188
common Linux problems	303	machine information	211, 213, 214, 221	wired network setup	150, 165
driver installation for network connected	158, 146, 147	machine setup		n-up printing	
printer properties	242, 241	machine status	211, 213, 214, 221	Mac	240
scanning	251, 124	maintenance parts	73	<b>O</b>	
using SetIP	152	manual feeder/multi-purpose tray		optional tray	
		loading	42	loading paper	41
		menu overview	33	overlay printing	
				create	237

# Index

delete	237	printing		scanning problems	297
print	237	changing the default print settings	231		
<b>P</b>		Linux	241	<b>R</b>	
placing a machine		Mac	239	rear view	23
adjusting the altitude	225	multiple pages on one sheet of paper		regulatory information	126
preparing originals type	50	Mac	240	reports	
print		printing a document		machine information	211, 214, 215, 216, 217, 218, 221
general setup	210	Windows	54	resolution	
mobile OS	196	Mac	240	faxing	68
print media		setting as a default machine	231, 233	<b>S</b>	
card stock	48	UNIX	242	safety	
envelope	45	using direct printing utility	238	information	15
labels	47	printing a document		symbols	15
output support	118	Linux	241	samsung printer experience	275
preprinted paper	49	Mac	239	Samsung Printer Status	273
setting the paper size	49, 44	UNIX	242	scan feature	245
transparency	46	printing feature	231	scanning	
print menu	210	problem		basic information	245
printer preferences		operating system problems	301	Linux scanning	251
Linux	242	problems		Mac scanning	250
printer status		copying problems	296	Scanning from image editing program	248, 246, 249
general information	273	faxing problems	299		
Printing	54	paper feeding problems	282, 283, 284, 288		

# Index

service contact numbers	304	adjusting the width and length	39	driver installation for network connected	
SetIP program	150, 188	changing the tray size	39	153,	29, 31
Special features	224	loading paper in manual		system requirements	121
specifications	116	feeder/multi-purpose tray	42	using SetIP	150, 188
print media	118	setting the paper size and type	49	wireless	
status	24, 26	<b>U</b>		ad hoc mode	165
supplies		understanding the status LED	107	Infrastructure mode	165
available supplies	72	UNIX		USB cable	171, 174
estimated toner cartridge life	75	driver installation for network connected		WPS	
monitoring the supplies life	84	159		disconnecting	169
ordering	72	printing	242	PBC mode	169
replacing toner cartridge	79	Unix		wireless network	
SyncThru Web Service		system requirements	123	network cable	187
general information	266	USB cable			
SyncThru™ Web Service	266	driver installation	29, 31, 144, 146, 145, 147		
<b>T</b>		using help	57, 241		
toner cartridge		<b>W</b>			
estimated life	75	watermark			
handling instructions	74	create	235		
non-Samsung and refilled	74	delete	236		
redistributing toner	76, 79	edit	236		
storing	74	Windows			
tray		common Windows problems	301		