

SCX-3200 Series

Multi-Functional Mono Printer User's Guide

imagine the possibilities

Thank you for purchasing a Samsung product.

The Samsung logo, consisting of the word "SAMSUNG" in white, uppercase, sans-serif font, centered within a blue, horizontally-oriented oval shape.

SAMSUNG

copyright

© 2010 Samsung Electronics Co., Ltd. All rights reserved.

This user's guide is provided for information purposes only. All information included herein is subject to change without notice.

Samsung Electronics is not responsible for any direct or indirect damages, arising from or related to use of this user's guide.

- Samsung and the Samsung logo are trademarks of Samsung Electronics Co., Ltd.
- PCL and PCL 6 are trademarks fo Hewlett-Packard Company.
- Microsoft, Windows, Windows Vista, Windows 7, and Windows Server 2008 R2 are either registered trademarks or trademarks of Microsoft Corporation.
- PostScript 3 is a trademark of Adobe System, Inc.
- USFT® and MicroType™ are registered trademarks of Monotype Imaging Inc.
- iPad, iPhone, iPod touch, TrueType, Mac and Mac OS are trademarks of Apple Inc., registered in the U.S and other countries. AirPrint and the AirPrint logo are trademarks of Apple Inc.
- LaserWriter is a trademark of Apple Inc.
- All other brand or product names are trademarks of their respective companies or organizations.

Refer to the 'LICENSE.txt' file in the provided CD-ROM for the open source license information.

REV. 1.01

safety information









These warnings and precautions are included to prevent injury to you and others, and to prevent any potential damage to your machine. Be sure to read and understand all of these instructions before using the machine.

Use common sense for operating any electrical appliance and whenever using your machine. Also, follow all warnings and instructions marked on the machine and in the accompanying literature. After reading this section, keep it in a safe place for future reference.

IMPORTANT SAFETY SYMBOLS

This section explains the meanings of all icons and signs in the user's guide. These safety symbols are in order, according to the degree of danger.

Explanation of all icons and signs used in the user's guide:

	Warning	Hazards or unsafe practices that may result in severe personal injury or death.
	Caution	Hazards or unsafe practices that may result in minor personal injury or property damage.
		Do not attempt.
		Do not disassemble.
		Do not touch.
		Unplug the power cord from the wall socket.
		Make sure the machine is grounded to prevent electric shock.
		Call the service center for help.
		Follow directions explicitly.

OPERATING ENVIRONMENT

Warning



Do not use if the power cord is damaged or if the electrical outlet is not grounded.

► This could result in electric shock or fire.



Do not bend, or place heavy objects on the power cord.

► Stepping on or allowing the power cord to be crushed by a heavy object could result in electric shock or fire.



Do not place anything on top of the machine (water, small metal or heavy objects, candles, lit cigarettes, etc.).

► This could result in electric shock or fire.



Do not remove the plug by pulling on the cord; do not handle the plug with wet hands.

► This could result in electric shock or fire.

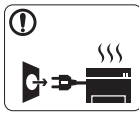

If the machine gets overheated, it releases smoke, makes strange noises, or generates an odd odor, immediately turn off the power switch and unplug the machine.

► This could result in electric shock or fire.

Caution

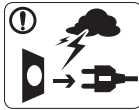



During an electrical storm or for a period of non-operation, remove the power plug from the electrical outlet.

► This could result in electric shock or fire.

-  Be careful, the paper output area is hot.
 - Burns could occur.

-  If the machine has been dropped, or if the cabinet appears damaged, unplug the machine from all interface connections and request assistance from qualified service personnel.
 - Otherwise, this could result in electric shock or fire.

-  If the machine exhibits a sudden and distinct change in performance, unplug the machine from all interface connections and request assistance from qualified service personnel.
 - Otherwise, this could result in electric shock or fire.

-  If the plug does not easily enter the electrical outlet, do not attempt to force it in.

► Call an electrician to change the electrical outlet, or this could result in electric shock.

-  Do not allow pets to chew on the AC power, telephone or PC interface cords.
 - This could result in electric shock or fire and/or injury to your pet.

-  If the machine does not operate properly after these instructions have been followed, unplug the machine from all interface connections and request assistance from qualified service personnel.
 - Otherwise, this could result in electric shock or fire.

OPERATING METHOD

Caution



Do not forcefully pull the paper out during printing.

► It can cause damage to the machine.



Be careful not to put your hand between the machine and paper tray.

► You may get injured.

-  Do not block or push objects into the ventilation opening.
 - This could result in elevated component temperatures which can cause damage or fire.

-  Be care when replacing paper or removing jammed paper.
 - New paper has sharp edges and can cause painful cuts.



When printing large quantities, the bottom part of the paper output area may get hot. Do not allow children to touch.

► Burns can occur.



When removing jammed paper, do not use tweezers or sharp metal objects.

► It can damage the machine.

-  Do not allow too many papers to stack up in the paper output tray.
 - It can damage the machine.

-  This machine's power interception device is the power cord.
 - To switch off the power supply, remove the power cord from the electrical outlet.

INSTALLATION / MOVING

Warning



Do not place the machine in an area with dust, humidity or water leaks.
▶ This could result in electric shock or fire.

Caution





Before moving the machine, turn the power off and disconnect all cords.
Then lift the machine:

- If the machine weighs under 20 kg (44.09lb), lift with 1 person.
- If the machine weighs 20 kg (44.09lb) - 40kg (88.18lb), lift with 2 people.
- If the machine weighs more than 40 kg (88.18lb), lift with 4 or more people.

▶ The machine could fall, causing injury or machine damage.

 Do not place the machine on an unstable surface.
▶ The machine could fall, causing injury or machine damage.

 The machine should be connected to the power level which is specified on the label.
▶ If you are unsure and want to check the power level you are using, contact the electrical utility company.

 Use only No.26 AWG^a or larger, telephone line cord, if necessary.
▶ Otherwise, it can cause damage to the machine.

 Do not put a cover over the machine or place it in an airtight location, such as a closet.
▶ If the machine is not well-ventilated, this could result in fire.

 Make sure you plug the power cord into a grounded electrical outlet.
▶ Otherwise, this could result in electric shock or fire.

 Do not overload wall outlets and extension cords.
▶ This can diminish performance, and could result in electric shock or fire.

 Use the power cord supplied with your machine for safe operation. If you are using a cord which is longer than 2 meters (6 feet) with a 140V machine, then the gauge should be 16 AWG or larger.
▶ Otherwise, it can cause damage to the machine, and could result in electric shock or fire.

a. AWG: American Wire Gauge

MAINTENANCE / CHECKING

Caution



Unplug this product from the wall outlet before cleaning the inside of the machine. **Do not** clean the machine with benzene, paint thinner or alcohol; do not spray water directly into the machine.

▶ This could result in electric shock or fire.



Keep cleaning supplies away from children.
▶ Children could get hurt.



When you are working inside the machine replacing supplies or cleaning the inside, do not operate the machine.

▶ You could get injured.

- ⓘ Keep the power cable and the contact surface of the plug clean from dust or water.
 - ▶ Otherwise, this could result in electric shock or fire.
- ⊗ Do not remove any covers or guards that are fastened with screws.
 - ▶ The machine should only be repaired by a Samsung service technician.



Do not disassemble, repair or rebuild the machine by yourself.

▶ It can damage the machine. Call a certified technician when the machine needs repair.

- ⓘ To clean and operate the machine, strictly follow the user's guide provided with the machine.
 - ▶ Otherwise, you could damage the machine.
- ⊗ Fuser units should only be repaired by a certified service technician.
 - ▶ Repair by non-certified technicians could result in fire or electric shock.

SUPPLY USAGE

Caution



Do not disassemble the toner cartridge.

▶ Toner dust can be dangerous if inhaled or ingested.



Do not burn any of the supplies such as toner cartridge or fuser unit.

▶ This could cause an explosion or uncontrollable fire.

- ⓘ When changing the toner cartridge or removing jammed paper, be careful not to let toner dust touch your body or clothes.
 - ▶ Toner dust can be dangerous if inhaled or ingested.



When storing supplies such as toner cartridges, keep them away from children.

▶ Toner dust can be dangerous if inhaled or ingested.

- ⊗ Using recycled supplies, such as toner, can cause damage to the machine.
 - ▶ In case of damage due to the use of recycled supplies, a service fee will be charged.
- ⓘ When toner gets on your clothing, do not use hot water to wash it.
 - ▶ Hot water sets toner into fabric. Use cold water.

regulatory information

This machine is designed for a normal work environment and certified with several regulatory statements.

LASER SAFETY STATEMENT

The printer is certified in the U.S. to conform to the requirements of DHHS 21 CFR, chapter 1 Subchapter J for Class I(1) laser products, and elsewhere is certified as a Class I laser product conforming to the requirements of IEC 60825-1:1993 + A1:1997 + A2:2001.

Class I laser products are not considered to be hazardous. The laser system and printer are designed so there is never any human access to laser radiation above a Class I level during normal operation, user maintenance or prescribed service condition.

- **Wavelength:** 800 nm
- **Beam divergence**
 - **Paraller:** 13 degrees
 - **Perpendicular:** 35 degrees
- **Maximum power or energy output:** 12 mW

WARNING

Never operate or service the printer with the protective cover removed from Laser/Scanner assembly. The reflected beam, although invisible, can damage your eyes.

When using this product, these basic safety precautions should always be followed to reduce risk of fire, electric shock, and injury to persons:



OZONE SAFETY



During normal operation, this machine produces ozone. The ozone produced does not present a hazard to the operator. However, it is advisable that the machine be operated in a well ventilated area.

If you need additional information about ozone, contact your local Samsung dealer.

POWER SAVE



This printer contains advanced energy conservation technology that reduces power consumption when it is not in active use. When the printer does not receive data for an extended period of time, power consumption is automatically lowered. ENERGY STAR and the ENERGY STAR mark are registered U.S. marks. For more information on the ENERGY STAR program see <http://www.energystar.gov>.

RECYCLING



Recycle or dispose of the packaging material for this product in an environmentally responsible manner.

CHINA ONLY

回收和再循环

为了保护环境，我公司已经为废弃的产品建立了回收和再循环系统。我们会为您无偿提供回收同类废旧产品的服务。当您要废弃您正在使用的产品时，请您及时与工厂取得联系，我们会及时为您提供服务。

CORRECT DISPOSAL OF THIS PRODUCT (WASTE ELECTRICAL & ELECTRONIC EQUIPMENT)

(Applicable in the European Union and other European countries with separate collection systems)



This marking shown on the product, accessories or literature indicates that the product and its electronic accessories (e.g. charger, headset, USB cable) should not be disposed of with other household wastes at the end of its working life. To prevent possible harm to the environment or human health from uncontrolled waste disposal, separate this from other types of wastes and recycle it responsibly to promote the sustainable reuse of material resources.

Household users should contact either the retailer where they purchased this product, or their local government office, for details of where and how they can take this item for environmentally safe recycling.

Business users should contact their supplier and check the terms and conditions of the purchase contract. This product should not be mixed with other commercial wastes for disposal.

RADIO FREQUENCY EMISSIONS

FCC Information to the User

This device complies with Part 15 of the FCC Rules. Operation is subject to the following two conditions:

- This device may not cause harmful interference, and
- This device must accept any interference received, including interference that may cause undesired operation.

This equipment has been tested and found to comply with the limits for a Class B digital device, pursuant to Part 15 of the FCC Rules. These limits are designed to provide reasonable protection against harmful interference in a residential installation. This equipment generates, uses and can radiate radio frequency energy and, if not installed and used in accordance with the instructions, may cause harmful interference to radio communications. However, there is no guarantee that interference will not occur in a particular installation. If this equipment does cause harmful interference to radio or television reception, which can be determined by turning the equipment off and on, the user is encouraged to try to correct the interference by one or more of the following measures:

- Reorient or relocate the receiving antenna.
- Increase the separation between the equipment and receiver.
- Connect the equipment into an outlet on a circuit different from that to which the receiver is connected.
- Consult the dealer or experienced radio TV technician for help.



Change or modifications not expressly approved by the manufacturer responsible for compliance could void the user's authority to operate the equipment.

Canadian Radio Interference Regulations

This digital apparatus does not exceed the Class B limits for radio noise emissions from digital apparatus as set out in the interference-causing equipment standard entitled "Digital Apparatus", ICES-003 of the Industry and Science Canada.

Cet appareil numérique respecte les limites de bruits radioélectriques applicables aux appareils numériques de Classe B prescrites dans la norme sur le matériel brouilleur: "Appareils Numériques", ICES-003 édictée par l'Industrie et Sciences Canada.

UNITED STATES OF AMERICA

Federal Communications Commission (FCC)

Intentional emitter per FCC Part 15

Low power, Radio LAN type devices (radio frequency (RF) wireless communication devices), operating in the 2.4 GHz/5 GHz Band, may be present (embedded) in your printer system. This section is only applicable if these devices are present. Refer to the system label to verify the presence of wireless devices.

Wireless devices that may be in your system are only qualified for use in the United States of America if an FCC ID number is on the system label.

The FCC has set a general guideline of 20 cm (8 inches) separation between the device and the body, for use of a wireless device near the body (this does not include extremities). This device should be used more than 20 cm (8 inches) from the body when wireless devices are on. The power output of the wireless device (or devices), which may be embedded in your printer, is well below the RF exposure limits as set by the FCC.

This transmitter must not be collocated or operation in conjunction with any other antenna or transmitter.

Operation of this device is subject to the following two conditions: (1) This device may not cause harmful interference, and (2) this device must accept any interference received, including interference that may cause undesired operation of the device.



Wireless devices are not user serviceable. Do not modify them in any way. Modification to a wireless device will void the authorization to use it. Contact manufacturer for service.

FCC Statement for Wireless LAN use:



While installing and operating this transmitter and antenna combination the radio frequency exposure limit of 1m W/cm² may be exceeded at distances close to the antenna installed. Therefore, the user must maintain a minimum distance of 20cm from the antenna at all times. This device cannot be collocated with another transmitter and transmitting antenna.

TURKEY ONLY

- **RoHS**

EEE Yönetmeliğine Uygundur.
This EEE is compliant with RoHS.

- Bu ürünün ortalama yaşam süresi 7 yıl, garanti süresi 2 yıldır.

GERMANY ONLY

Das Gerät ist nicht für die Benutzung am Bildschirmarbeitsplatz gemäß Bildschirmarbeitsverordnung vorgesehen.



REPLACING THE FITTED PLUG (FOR UK ONLY)

Important

The mains lead for this machine is fitted with a standard (BS 1363) 13 amp plug and has a 13 amp fuse. When you change or examine the fuse, you must re-fit the correct 13 amp fuse. You then need to replace the fuse cover. If you have lost the fuse cover, do not use the plug until you have another fuse cover.

Contact the people from you purchased the machine.

The 13 amp plug is the most widely used type in the UK and should be suitable. However, some buildings (mainly old ones) do not have normal 13 amp plug sockets. You need to buy a suitable plug adaptor. Do not remove the moulded plug.



If you cut off the moulded plug, get rid of it straight away.

You cannot rewire the plug and you may receive an electric shock if you plug it into a socket.

Important warning:



You must earth this machine.

The wires in the mains lead have the following color code:

- **Green and Yellow:** Earth
- **Blue:** Neutral
- **Brown:** Live

If the wires in the mains lead do not match the colors marked in your plug, do the following:

You must connect the green and yellow wire to the pin marked by the letter “E” or by the safety ‘Earth symbol’ or colored green and yellow or green.

You must connect the blue wire to the pin which is marked with the letter “N” or colored black.

You must connect the brown wire to the pin which is marked with the letter “L” or colored red.

You must have a 13 amp fuse in the plug, adaptor, or at the distribution board.

DECLARATION OF CONFORMITY (EUROPEAN COUNTRIES)

Approvals and Certifications



The CE marking applied to this product symbolizes Samsung Electronics Co., Ltd. Declaration of Conformity with the following applicable 93/68/EEC Directives of the European Union as of the dates indicated:

SCX-3200 Series: Low Voltage Directive (2006/95/EC), EMC Directive (2004/108/EC)

SCX-3205W(K): R&TTE Directive (1999/5/EC)

The declaration of conformity may be consulted at www.samsung.com/printer, go to Support > Download center and enter your printer (MFP) name to browse the EuDoC.

January 1, 1995: Council Directive 2006/95/EC Approximation of the laws of the member states related to low voltage equipment.

January 1, 1996: Council Directive 2004/108/EC (92/31/EEC), approximation of the laws of the Member States related to electromagnetic compatibility.

March 9, 1999: Council Directive 1999/5/EC on radio equipment and telecommunications terminal equipment and the mutual recognition of their conformity. A full declaration, defining the relevant Directives and referenced standards can be obtained from your Samsung Electronics Co., Ltd. representative.

EC Certification

Certification to 1999/5/EC Radio Equipment & Telecommunications Terminal Equipment Directive (FAX)

This Samsung product has been self-certified by Samsung for pan-European single terminal connection to the analogue public switched telephone network (PSTN) in accordance with Directive 1999/5/EC. The product has been designed to work with the national PSTNs and compatible PBXs of the European countries:

In the event of problems, you should contact the Euro QA Lab of Samsung Electronics Co., Ltd. in the first instance.

The product has been tested against TBR21. To assist in the use and application of terminal equipment which complies with this standard, the European Telecommunication Standards Institute (ETSI) has issued an advisory document (EG 201 121) which contains notes and additional requirements to ensure network compatibility of TBR21 terminals. The product has been designed against, and is fully compliant with, all of the relevant advisory notes contained in this document.

European Radio Approval Information (for products fitted with EU-approved radio devices)

Low power, Radio LAN type devices (radio frequency (RF) wireless communication devices), operating in the 2.4 GHz/5 GHz band, may be present (embedded) in your printer system which is intended for home or office use. This section is only applicable if these devices are present. Refer to the system label to verify the presence of wireless devices.

Wireless devices that may be in your system are only qualified for use in the European Union or associated areas if a CE mark with **CE** a Notified Body Registration Number and the Alert Symbol is on the system label.

The power output of the wireless device or devices that may be embedded in you printer is well below the RF exposure limits as set by the European Commission through the R&TTE directive.

European States qualified under wireless approvals:

EU

Austria, Belgium, Cyprus, Czech Republic, Denmark, Estonia, Finland, France (with frequency restrictions), Germany, Greece, Hungary, Ireland, Italy, Latvia, Lithuania, Luxembourg, Malta, The Netherlands, Poland, Portugal, Slovakia, Slovenia, Spain, Sweden and the U.K.

EEA/EFTA countries

Iceland, Liechtenstein, Norway and Switzerland

European States with restrictions on use:

EU

In France, the frequency range is restricted to 2446.5-2483.5 MHz for devices above 10 mW transmitting power such as wireless EEA/EFTA countries

No limitations at this time

REGULATORY COMPLIANCE STATEMENTS

Wireless Guidance

Low power, Radio LAN type devices (radio frequency (RF) wireless communication devices), operating in the 2.4 GHz/5 GHz Band, may be present (embedded) in your printer system. The following section is a general overview of considerations while operating a wireless device.

Additional limitations, cautions, and concerns for specific countries are listed in the specific country sections (or country group sections). The wireless devices in your system are only qualified for use in the countries identified by the Radio Approval Marks on the system rating label. If the country you will be using the wireless device in, is not listed, contact your local Radio Approval agency for requirements. Wireless devices are closely regulated and use may not be allowed.

The power output of the wireless device or devices that may be embedded in your printer is well below the RF exposure limits as known at this time. Because the wireless devices (which may be embedded into your printer) emit less energy than is allowed in radio frequency safety standards and recommendations, manufacturer believes these devices are safe for use. Regardless of the power levels, care should be taken to minimize human contact during normal operation.





As a general guideline, a separation of 20 cm (8 inches) between the wireless device and the body, for use of a wireless device near the body (this does not include extremities) is typical. This device should be used more than 20 cm (8 inches) from the body when wireless devices are on and transmitting.

This transmitter must not be collocated or operation in conjunction with any other antenna or transmitter.

Some circumstances require restrictions on wireless devices. Examples of common restrictions are listed below:



Radio frequency wireless communication can interfere with equipment on commercial aircraft. Current aviation regulations require wireless devices to be turned off while traveling in an airplane. IEEE 802.11 (also known as wireless Ethernet) and Bluetooth communication devices are examples of devices that provide wireless communication.

-  In environments where the risk of interference to other devices or services is harmful or perceived as harmful, the option to use a wireless device may be restricted or eliminated. Airports, Hospitals, and Oxygen or flammable gas laden atmospheres are limited examples where use of wireless devices may be restricted or eliminated. When in environments where you are uncertain of the sanction to use wireless devices, ask the applicable authority for authorization prior to use or turning on the wireless device.
-  Every country has different restrictions on the use of wireless devices. Since your system is equipped with a wireless device, when traveling between countries with your system, check with the local Radio Approval authorities prior to any move or trip for any restrictions on the use of a wireless device in the destination country.
-  If your system came equipped with an internal embedded wireless device, do not operate the wireless device unless all covers and shields are in place and the system is fully assembled.
-  Wireless devices are not user serviceable. Do not modify them in any way. Modification to a wireless device will void the authorization to use it. Contact manufacturer for service.
-  Only use drivers approved for the country in which the device will be used. See the manufacturer System Restoration Kit, or contact manufacturer Technical Support for additional information.

OPENSSL LICENSE

Copyright (c) 1998-2001 The OpenSSL Project. All rights reserved.

Redistribution and use in source and binary forms, with or without modification, are permitted provided that the following conditions are met:

1. Redistributions of source code must retain the above copyright notice, this list of conditions and the following disclaimer.
2. Redistributions in binary form must reproduce the above copyright notice, this list of conditions and the following disclaimer in the documentation and/or other materials provided with the distribution.
3. All advertising materials mentioning features or use of this software must display the following acknowledgment: "This product includes software developed by the OpenSSL Project for use in the OpenSSL Toolkit (<http://www.openssl.org/>)".
4. The names "OpenSSL Toolkit" and "OpenSSL Project" must not be used to endorse or promote products derived from this software without Prior written permission. For written permission, please contact openssl-core@openssl.org.
5. Products derived from this software may not be called "OpenSSL" nor may "OpenSSL" appear in their names without prior written permission of the OpenSSL Project.
6. Redistributions of any form whatsoever must retain the following acknowledgment: "This product includes software developed by the OpenSSL Project for use in the OpenSSL Toolkit (<http://www.openssl.org/>)".

THIS SOFTWARE IS PROVIDED BY THE OpenSSL PROJECT "AS IS" AND ANY EXPRESSED OR IMPLIED WARRANTIES, INCLUDING, BUT NOT LIMITED TO, THE IMPLIED WARRANTIES OF MERCHANTABILITY AND FITNESS FOR A PARTICULAR PURPOSE ARE DISCLAIMED. IN NO EVENT SHALL THE OpenSSL PROJECT OR ITS CONTRIBUTORS BE LIABLE FOR ANY DIRECT, INDIRECT, INCIDENTAL, SPECIAL, EXEMPLARY, OR CONSEQUENTIAL DAMAGES (INCLUDING, BUT NOT LIMITED TO, PROCUREMENT OF SUBSTITUTE GOODS OR SERVICES; LOSS OF USE, DATA, OR PROFITS; OR BUSINESS INTERRUPTION) HOWEVER CAUSED AND ON ANY THEORY OF LIABILITY, WHETHER IN CONTRACT, STRICT LIABILITY, OR TORT (INCLUDING NEGLIGENCE OR OTHERWISE) ARISING IN ANY WAY OUT OF THE USE OF THIS SOFTWARE, EVEN IF ADVISED OF THE POSSIBILITY OF SUCH DAMAGE.

This product includes cryptographic software written by Eric Young (eay@cryptsoft.com). This product includes software written by Tim Hudson (tjh@cryptsoft.com).

ORIGINAL SSLEAY LICENSE

Copyright (C) 1995-1998 Eric Young (eay@cryptsoft.com) All rights reserved.

This package is an SSL implementation written by Eric Young (eay@cryptsoft.com). The implementation was written so as to conform with Netscapes SSL.

This library is free for commercial and non-commercial use as long as the following conditions are adhered to. The following conditions apply to all code found in this distribution, be it the RC4, RSA, lhash, DES, etc., code; not just the SSL code. The SSL documentation included with this distribution is covered by the same copyright terms except that the holder is Tim Hudson (tjh@cryptsoft.com). Copyright remains Eric Young's, and as such any Copyright notices in the code are not to be removed. If this package is used in a product, Eric Young should be given attribution as the author of the parts of the library used. This can be in the form of a textual message at program startup or in documentation (online or textual) provided with the package.

Redistribution and use in source and binary forms, with or without modification, are permitted provided that the following conditions are met:

1. Redistributions of source code must retain the copyright notice, this list of conditions and the following disclaimer.
2. Redistributions in binary form must reproduce the above copyright notice, this list of conditions and the following disclaimer in the documentation and/or other materials provided with the distribution.

3. All advertising materials mentioning features or use of this software must display the following acknowledgement: "This product includes cryptographic software written by Eric Young (eay@cryptsoft.com)" The word 'cryptographic' can be left out if the routines from the library being used are not cryptographic related.
4. If you include any Windows specific code (or a derivative thereof) from the apps directory (application code) you must include an acknowledgement: "This product includes software written by Tim Hudson (tjh@cryptsoft.com)".

THIS SOFTWARE IS PROVIDED BY ERIC YOUNG "AS IS" AND ANY EXPRESS OR IMPLIED WARRANTIES, INCLUDING, BUT NOT LIMITED TO, THE IMPLIED WARRANTIES OF MERCHANTABILITY AND FITNESS FOR A PARTICULAR PURPOSE ARE DISCLAIMED. IN NO EVENT SHALL THE AUTHOR OR CONTRIBUTORS BE LIABLE FOR ANY DIRECT, INDIRECT, INCIDENTAL, SPECIAL, EXEMPLARY, OR CONSEQUENTIAL DAMAGES (INCLUDING, BUT NOT LIMITED TO, PROCUREMENT OF SUBSTITUTE GOODS OR SERVICES; LOSS OF USE, DATA, OR PROFITS; OR BUSINESS INTERRUPTION) HOWEVER CAUSED AND ON ANY THEORY OF LIABILITY, WHETHER IN CONTRACT, STRICT LIABILITY, OR TORT (INCLUDING NEGLIGENCE OR OTHERWISE) ARISING IN ANY WAY OUT OF THE USE OF THIS SOFTWARE, EVEN IF ADVISED OF THE POSSIBILITY OF SUCH DAMAGE.

The licence and distribution terms for any publicly available version or derivative of this code cannot be changed. i.e. this code cannot simply be copied and put under another distribution licence [including the GNU Public Licence.

产品中有毒有害物质或元素的名称及含量

部件名称	有毒有害物质或元素					
	铅 (Pb)	汞 (Hg)	镉 (Cd)	六价铬 (Cr ⁶⁺)	多溴联苯 (PBB)	多溴联苯醚 (PBDE)
塑料	○	○	○	○	○	○
金属 (机箱)	X	○	○	○	○	○
印刷电路部件 (PCA)	X	○	○	○	○	○
电缆 / 连接器	X	○	○	○	○	○
电源设备	X	○	○	○	○	○
电源线	X	○	○	○	○	○
机械部件	X	○	○	○	○	○
卡盒部件	X	○	○	○	○	○
定影部件	X	○	○	○	○	○
扫描仪部件 - CCD (如果有)	X	X	○	○	○	○
扫描仪部件 - 其它 (如果有)	X	○	○	○	○	○
印刷电路板部件 (PBA)	X	○	○	○	○	○
墨粉	○	○	○	○	○	○
滚筒	○	○	○	○	○	○

○：表示该有毒有害物质在该部件所有均质材料中的含量均在 SJ/T 11363-2006 标准规定的限量要求以下。

×：表示该有毒有害物质至少在该部件的某一均质材料中的含量超出 SJ/T 11363-2006 标准规定的限量要求。

以上表为目前本产品含有有毒有害物质的信息。本信息由本公司的配套厂家提供，经本公司审核后而做成，本产品的部分部件含有有毒有害物质，这些部件是在现有科学技术水平下暂时无可替代物质，但三星电子将会一直为满足 SJ/T 11363-2006 标准而做不懈的努力。

about this user's guide

This user's guide provides information about basic understanding of the machine as well as detailed explanation on each step during actual usage. It is a valuable resource for both novice and professional users for the proper installation and use of the machine.



-  Read the safety information before using the machine.
- If you have a problem using the machine, refer to the troubleshooting chapter (See "Troubleshooting" on page 77).
- Terms used in this user's guide are explained in the glossary chapter (See "Glossary" on page 96).
- Illustrations in this user's guide may differ from your machine depending on its options or models.
- The procedures in this user's guide are mainly based on Windows XP.

CONVENTION

Some terms in this guide are used interchangeably, as below:

- Document is synonymous with original.
- Paper is synonymous with media, or print media.
- Machine refers to printer or MFP.

The following table offers the conventions of this guide:

CONVENTION	DESCRIPTION	EXAMPLE
Bold	For texts on the display or button names on the machine.	Power
Note	Provides additional information or details for the machine function and feature.	 The date format may differ from country to country.
Caution	Contains information you can use to protect the machine from possible mechanical damage or malfunction.	 Do not touch the surface of the drum located in the toner cartridge or imaging unit.
Footnote	Provides additional information on certain words or a phrases.	a. pages per minute
("Cross-reference")	Refers you to additional detailed information.	(See "Finding more information" on page 16).

FINDING MORE INFORMATION

You can find information about setting up and using your machine in the following resources, either as a print-out or on screen.

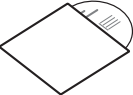
MATERIAL NAME	DESCRIPTION
Quick Installation Guide 	This guide provides information on setting up your machine. This guide is provided in the box with the printer.
User's Guide 	This guide provides you with step-by-step instructions for using your machine's full features, maintaining your machine, troubleshooting, and replacing supplies.
Machine Driver Help	This help provides you with information about the printer driver and instructions for setting up the options for printing (See "Using help" on page 56).
Samsung website	If you have Internet access, you can get help, support, machine drivers, manuals, and order information from the Samsung website, www.samsung.com/printer .
Downloadable software	You can download useful software programs from the Samsung website. <ul style="list-style-type: none">• Samsung AnyWeb Print: helps personal users to screen-capture the website screen in Windows Internet Explorer easily. (http://solution.samsungprinter.com/personal/anywebprint)• SyncThru™ Web Admin Service: provides convenient tools for network administrators who need to manage many machines simultaneously. This program is for network model only. (http://solution.samsungprinter.com, See "Features by Models" on page 18)

features of your new product

Your new machine is equipped with a number of special features that improve the quality of the documents you print.

SPECIAL FEATURES

Print with excellent quality and speed



- You can print with a resolution of up to 1200 x 1200 dpi effective output.
- Your machine prints A4-sized paper at up to 16 ppm and letter-sized paper at up to 17 ppm.

Handle many different types of printable material

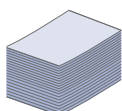

- The 150-sheet tray supports plain paper in various sizes, letterhead, envelopes, labels, custom-sized media, postcards, and heavy paper.

Create professional documents

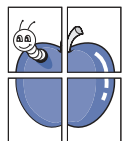

- Print Watermarks. You can customize your documents with words, such as "Confidential" (See "Using watermarks" on page 57).
- Print Posters. The text and pictures of each page of your document are magnified and printed across the sheet of paper and can then be taped together to form a poster (See "Printing posters" on page 56).
- You can use preprinted forms and letterhead with plain paper (See "Using overlays" on page 58).

Save time and money



- To save paper, you can print multiple pages on one single sheet of paper (See "Printing multiple pages on one sheet of paper" on page 56).
- This machine automatically conserves electricity by substantially reducing power consumption when not in use.
- To save paper, you can print on both sides of the paper manually (See "Printing on both sides of the paper (Manual)" on page 56).

Print in various environments



- You can print with various operating systems such as Windows, Linux, and Macintosh OS systems.
- Your machine is equipped with a Hi-Speed USB 2.0 interface.
- Your machine comes with a built-in network interface, Ethernet 10/100 BaseTX. SCX-3205W(K) only
- Your machine comes with a built-in network interface 802.11 b/g/n wireless LAN. (SCX-3205W(K) only) For some counties, only 802.11 b/g can be applied.

Copy the original in high quality

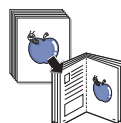

- You can copy the original and print them in enhanced image quality and size.

Scan the originals

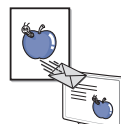

- Scan in color and use the precise compressions of BMP, JPEG, TIFF and PDF formats.
- Use one button to scan your original to the connected computer.

Eco Print



- You can reduce toner and paper usage (See "Eco Print button" on page 22).

IPv6 (SCX-3205W(K) only)

- The machine supports IPv6 (See "IPv6 Configuration" on page 34).

AirPrint



AirPrint allows you to wirelessly print directly from iPhone, iPad and iPod touch running iOS 4.2 or later.

FEATURES BY MODELS

The machine is designed to support all of your document needs from printing to more advanced networking solutions for your business. Features by models include:

FEATURES	SCX-3200 SERIES	SCX-3205W(K) SERIES
Print	•	•
Eco Print	•	•
Duplex (2-sided) printing (manual)	•	•
Copy	•	•
Scan	•	•
Hi-Speed USB 2.0	•	•
Print Screen	•	
IPv6		•
Network Interface Ethernet 10/100 Base TX wired LAN		•
Network Interface 802.11b/g/n wireless LAN ^a		•
SyncThru™ Web Service		•

a. Depending on your country, wireless LAN card may not be available. For some counties, only 802.11 b/g can be applied. Contact your local Samsung dealer or the retailer where you bought your machine.

(●: Included, Blank: Not included)

introduction

This chapter gives you an overview of your machine:

This chapter includes:

- Machine overview
- Control panel overview
- Understanding the status LED
- Introducing the useful buttons

MACHINE OVERVIEW

Front view

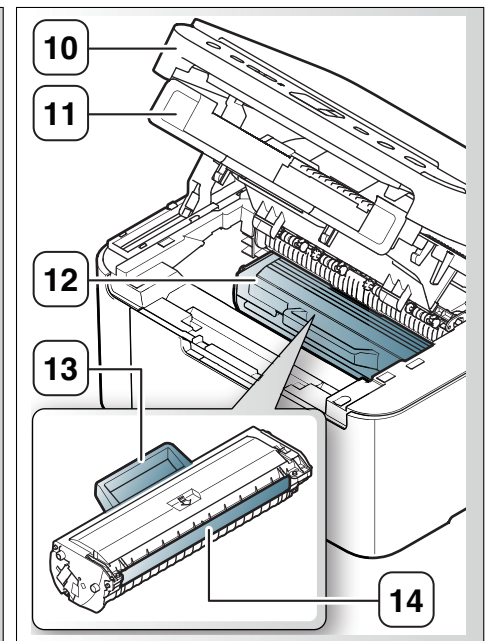
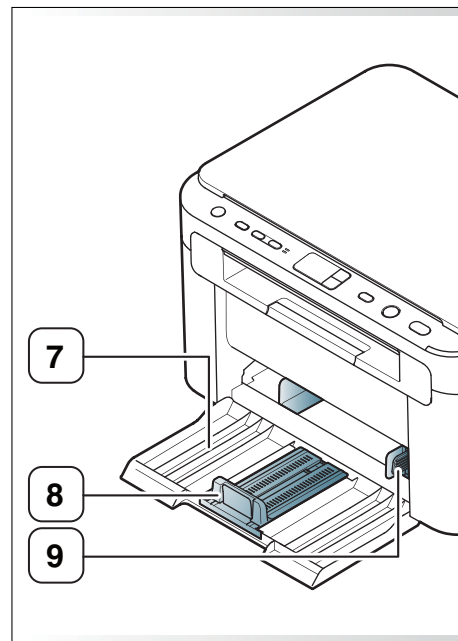
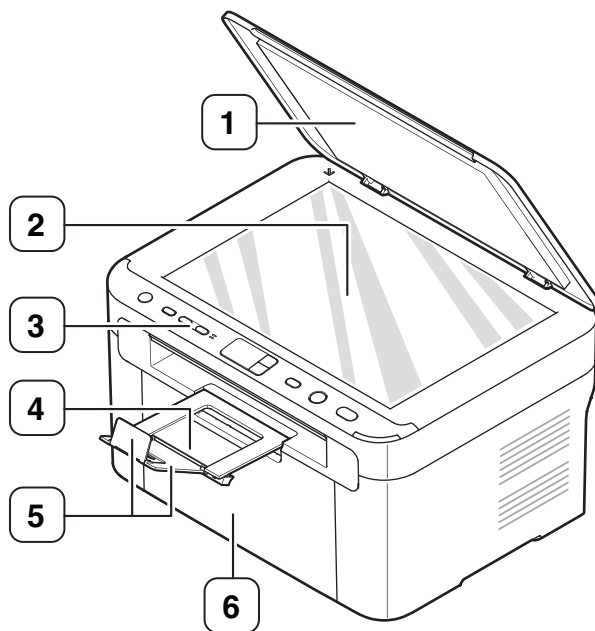

This illustration may differ from your machine depending on its model.

1	Scanner lid	6	Front door	11	Inner cover
2	Scanner glass	7	Tray	12	Toner cartridge
3	Control panel	8	Paper length guide	13	Toner cartridge handle
4	Output tray (face down)	9	Paper width guide	14	Toner cartridge drum
5	Output support	10	Scan unit		

Rear view

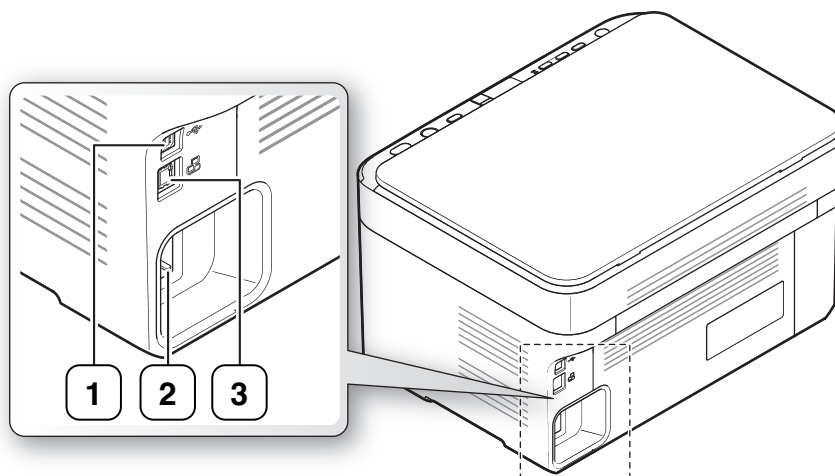

This illustration may differ from your machine depending on its model.

- 1 USB port
- 2 Power cord receptacle
- 3 Network port^a

a. SCX-3205W(K) only

CONTROL PANEL OVERVIEW

This control panel may differ from your machine depending on its model.

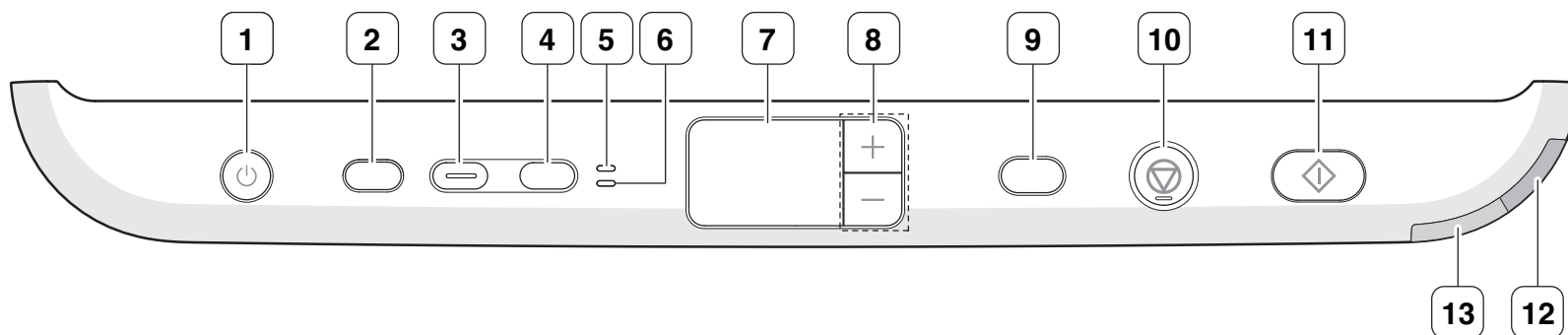

1	Power (⏻)	Allows you to turn the power on or off (See "Power button" on page 23).
2	Eco Print	Turn the Eco mode on or off (See "Eco Print button" on page 22).
3	Scan to	Sends scanned data (See "Scanning originals and sending to your computer (Scan to PC)" on page 64).
4	ID Copy	Allows you to copy both sides the ID card like a driver's license to a single side of paper (See "ID card copying" on page 63).
5	Front LED	When the LED lights on, place the front side of an ID card facing down on the scanner glass (See "ID card copying" on page 63).
6	Back LED	When the LED lights on, place the back side of an ID card facing down on the scanner glass (See "ID card copying" on page 63).
7	Display	Shows the number of pages you want to copy.
8	+/- Buttons	Allows you to increase/decrease the number of page you want to copy (See "+/- buttons" on page 22).
9	Print Screen (SCX-3200 only)	Prints the displayed screen of your monitor (See "Print Screen button (SCX-3200 only)" on page 22).
	WPS (SCX-3205W(K) only)	Allows you to turn on or off the wireless network connection (See "WPS button (SCX-3205W(K))" on page 22).
10	Stop/Clear (⏹)	Stops an operation at any time and there are more functions (See "Stop/Clear button" on page 23).
11	Start (◊)	Begins a printing, copying or scanning job depending on which function you are using.
12	Wireless LED (SCX-3205W(K) only)	Shows the current status of the wireless network connection (See "Understanding the status LED" on page 22).
13	Status LED	Shows the status of your machine (See "Understanding the status LED" on page 22).

UNDERSTANDING THE STATUS LED

Status LED

The color of the LED indicates the machine's current status.



STATUS LED		DESCRIPTION
Off		<ul style="list-style-type: none">The machine is off-line.The machine is in sleep mode.
Green	On	<ul style="list-style-type: none">The machine is in ready mode or warming up.
	Blinking	<ul style="list-style-type: none">When the LED blinks slowly, the machine is receiving data from the computer or printing documents.When the LED blinks rapidly, the machine is operating special functions.
Red	On	<ul style="list-style-type: none">The inner cover is opened. Close the inner cover completely.There is no paper in the tray. Load paper in the tray.The machine has stopped due to a major error.Your system has some problems. If this problem occurs, contact a service representative.A toner cartridge has almost reached its estimated cartridge life^a. It is recommended to replace the toner cartridge (See "Replacing the toner cartridge" on page 89).
	Blinking	<ul style="list-style-type: none">A small amount of toner is left in the cartridge. The estimated cartridge life^a of toner is close. Prepare a new cartridge for replacement. You may temporarily increase the printing quality by redistributing the toner (See "Redistributing toner" on page 77).The machine is printing in manual feed mode or in manual duplex mode.
Orange	On	A paper jam has occurred (See "Clearing paper jams" on page 78).

a. Estimated cartridge life means the expected or estimated toner cartridge life, which indicates the average capacity of print-outs and is designed pursuant to ISO/IEC 19752. The number of pages may be affected by operating environment, percentage of image area, printing interval, media type, and media size. Some amount of toner may remain in the cartridge even when red LED is on and the printer stops printing.

 Samsung does not recommend using a non-genuine Samsung toner cartridge such as one that is refilled or remanufactured. Samsung cannot guarantee a non-genuine Samsung toner cartridge's quality. Service or repair required as a result of using non-genuine Samsung toner cartridges will not be covered under the machine warranty.

 All printing errors will appear in the Smart Panel program window. If the problem persists, contact a service representative.

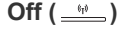
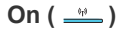
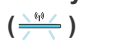
Wireless LED (SCX-3205W(K) only)

WIRELESS LED STATUS		DESCRIPTION
Blue	Off ()	Wireless network is disconnected.
	On ()	Wireless network is connected.
	Slowly blinks ()	The machine starts connecting to a wireless network.
	Fast blinks ()	<ul style="list-style-type: none">The machine is connecting to access point (or wireless router).Wireless network connection is being disconnected.

INTRODUCING THE USEFUL BUTTONS

Print Screen button (SCX-3200 only)

If you press **Print Screen** button for less than two seconds, the green light blinks fast on the **Status LED**, and then the machine prints the whole screen displayed in the monitor.

If you press **Print Screen** button for more than two seconds, the **Status LED** lights on green, and then the machine prints an active screen displayed in the monitor.



- The page will be printed on the default page like A4 or Letter.
- Print Screen** can only be used in the Windows and Macintosh operating systems.
- You can only use this function with a USB-connected machine.
- You can use this function only when the Smart Panel program is installed and running.
- You can only use this function in **Eco Print** mode off.

Eco Print button

You can turn the **Eco Print** mode on or off by simply pressing the button. If you set the **Eco Print** mode on, the machine automatically sets the **2-UP** and **Toner Save** option on and print with those options.

- Press **Eco Print** button on the control panel.
- Eco Print** LED lights on. Then, Eco Print mode is on.

To turn off Eco Print mode, press **Eco Print** button one more time.

+/- buttons

You can determine the number of copies (up to 99 copies) you want to copy by pressing +/- buttons. The default setting value is 1.

- If you press +/- buttons briefly, the number of copies increases/decreases by single digits.
- If you press +/- buttons long, the number of copies increases/decreases by ten-fold.

WPS button (SCX-3205W(K))

This feature automatically detects which WPS (Wi-Fi Protected Setup™) mode your access point uses. By pushing a button on the wireless LAN router/access point and the machine, you can setup the wireless network and security settings (See "Wireless network setup (SCX-3205W(K))" on page 36).

Stop/Clear button

By pressing  **Stop/Clear** button, you can do the following functions.

FUNCTION	DESCRIPTION
Printing a configuration report	In ready mode, press and hold this button long enough (about two seconds) until the Status LED blinks slowly, and release the button (See "To print a configuration report" on page 24).
Printing a network configuration report (SCX-3205W(K) only)	In ready mode, press and hold this button for four seconds until the Status LED blinks fast, and release the button (See "Printing a network configuration report" on page 30).
Supplies information report	In the ready mode, press and hold this button for about 6 seconds until the Status LED is on, and release (See "To print a supplies information report" on page 24).
Canceling print job	Press  Stop/Clear button during a operation. The print job is cleared from both the machine and the computer and then the machine returns to ready mode. This may take some time depending on the size of the print job.

Power button

By pressing  **Power** button, you can turn the machine on or off.

Turning on the machine

1. Plug in the power cord.
2. Press  **Power** button on the control panel.
When the machine is powered on, you can see LED looping on the display. Then, the machine is in ready mode.

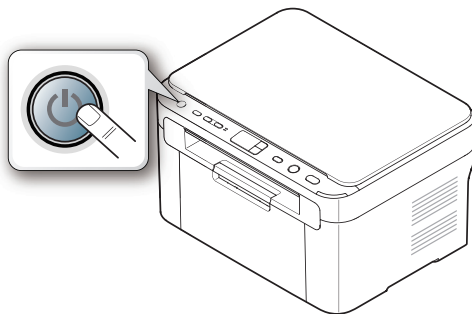

-  If you want to turn the power off, press and hold this button for about two seconds.

getting started

This chapter gives you step-by-step instructions for setting up the USB connected machine and software.

This chapter includes:

- Setting up the hardware
- Printing a report
- Supplied software
- System requirements
- Installing USB connected machine's driver
- Sharing your machine locally

SETTING UP THE HARDWARE

This section shows the steps to set up the hardware, as is explained in the Quick Installation Guide. Make sure you read the Quick Installation Guide first and follow the steps below:

Location

1. Select a stable location.

Select a level, stable place with adequate space for air circulation. Allow extra space for opening cover(s) and tray(s).

The area should be well ventilated and away from direct sunlight or sources of heat, cold, and humidity. Do not set the machine close to the edge of your desk or table.

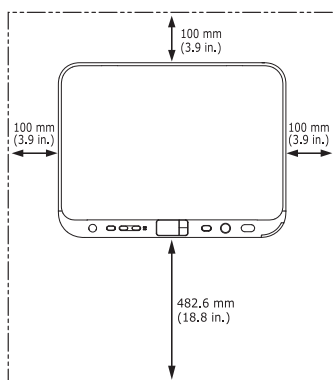

Printing is suitable for altitudes under 1,000 m (3,281 ft). Refer to the altitude setting to optimize your printing (See "Altitude adjustment" on page 46).

Place the machine on a flat, stable surface so that there is no incline greater than 2 mm (0.08 inch). Otherwise, printing quality may be affected.

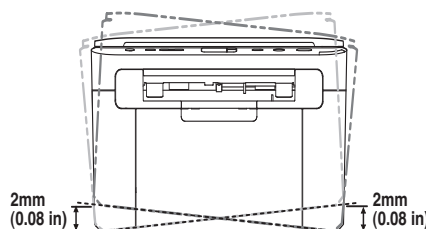

2. Unpack the machine and check all the enclosed items.
3. Remove tape holding the machine securely.
4. Install the toner cartridge.
5. Load paper (See "Loading originals" on page 48).

6. Make sure that all cables are connected to the machine.
7. Turn the machine on (See "Turning on the machine" on page 23).



This machine will not operate when the power main fails.

PRINTING A REPORT

Print a configuration or supplies information page to make sure that the machine is operating properly.

To print a configuration report

In the ready mode, press and hold  **Stop/Clear** button on the control panel for long enough (about two seconds) until the **Status LED** blinks slowly, and release.



For SCX-3205W(K), you can print a network configuration report (See "Printing a network configuration report" on page 30).

To print a supplies information report

In the ready mode, press and hold  **Stop/Clear** button on the control panel for about six seconds until the **Status LED** lights on, and release.

SUPPLIED SOFTWARE

After you have set up your machine and connected it to your computer, you must install the printer software. If you are a Windows or Macintosh OS user, install the software from the supplied CD and if you are a Linux OS user, download the software from the Samsung website (www.samsung.com/printer) and install.



Machine software is occasionally updated for reasons like the release of new operating system and etc. If needed, download the latest version from the Samsung website (www.samsung.com/printer).

OS	CONTENTS
Windows	<ul style="list-style-type: none"> • Printer driver: Use this driver to take full advantage of your machine's features. • Scanner driver: TWAIN and Windows Image Acquisition (WIA) drivers are available for scanning documents on your machine. • Smart Panel: This program allows you to monitor the machine's status and alerts you when an error occurs during printing (See "Using the Smart Panel program" on page 70). • SmarThru^a: This program is the accompanying Windows-based software for your multifunctional machine. • Samsung Scan and Fax Manager: You can find out about Samsung Scan and Fax Manager program information and installed scan driver's condition. • Printer Settings Utility: This program allows you to set up printer's other options from your computer. • SetIP: Use this program to set your machine's TCP/IP addresses. (SCX-3205W(K) only)
Macintosh	<ul style="list-style-type: none"> • Printer Driver: Use this driver to take full advantage of your machine's features. • Scanner driver: TWAIN driver is available for scanning documents on your machine. • Smart Panel: This program allows you to monitor the machine's status and alerts you when an error occurs during printing (See "Using the Smart Panel program" on page 70). • Samsung Scan and Fax Manager: You can find out about Samsung Scan and Fax Manager program information and installed scan driver's condition. • Printer Settings Utility: This program allows you to set up printer's other options from your computer. • SetIP: Use this program to set your machine's TCP/IP addresses. (SCX-3205W(K) only)
Linux	<ul style="list-style-type: none"> • Unified Linux Driver: Use this driver to take full advantage of your machine's features. • SANE: Use this driver to scan documents. • Smart Panel: This program allows you to monitor the machine's status and alerts you when an error occurs during printing (See "Using the Smart Panel program" on page 70). • Printer Settings Utility: This program allows you to set up printer's other options from your computer. • SetIP: Use this program to set your machine's TCP/IP addresses. (SCX-3205W(K) only)

a. Allows you to edit a scanned image in various ways using a powerful image editor and to send the image by email. You can also open another image editor program such as Adobe Photoshop, from SmarThru. For details, refer to the on-screen help supplied on the SmarThru program (See "SmarThru" on page 70).

SYSTEM REQUIREMENTS

Before you begin, ensure that your system meets the following requirements:

Windows

Your machine supports the following Windows operating systems.

OPERATING SYSTEM	REQUIREMENT (RECOMMENDED)		
	CPU	RAM	FREE HDD SPACE
Windows® 2000	Intel® Pentium® II 400 MHz (Pentium III 933 MHz)	64 MB (128 MB)	600 MB
Windows® XP	Intel® Pentium® III 933 MHz (Pentium IV 1 GHz)	128 MB (256 MB)	1.5 GB
Windows Server® 2003	Intel® Pentium® III 933 MHz (Pentium IV 1 GHz)	128 MB (512 MB)	1.25 GB to 2 GB
Windows Server® 2008	Intel® Pentium® IV 1 GHz (Pentium IV 2 GHz)	512 MB (2 GB)	10 GB
Windows Vista®	Intel® Pentium® IV 3 GHz	512 MB (1 GB)	15 GB
Windows® 7	Intel® Pentium® IV 1 GHz 32-bit or 64-bit processor or higher	1 GB (2 GB)	16 GB
			<ul style="list-style-type: none"> • Support for DirectX® 9 graphics with 128 MB memory (to enable the Aero theme). • DVD-R/W Drive
Windows Server® 2008 R2	Intel® Pentium® IV 1 GHz (x86) or 1.4 GHz (x64) processors (2 GHz or faster)	512 MB (2 GB)	10 GB

-  Internet Explorer® 5.0 or higher is the minimum requirement for all Windows operating systems.
- **Windows Terminal Services** is compatible with your machine.

Macintosh

OPERATING SYSTEM	REQUIREMENTS (RECOMMENDED)		
	CPU	RAM	FREE HDD SPACE
Mac OS X 10.3 ~ 10.4	<ul style="list-style-type: none"> • Intel® Processors • PowerPC G4/ G5 	<ul style="list-style-type: none"> • 128 MB for a PowerPC based Mac (512 MB) • 512 MB for a Intel-based Mac (1 GB) 	1 GB

OPERATING SYSTEM	REQUIREMENTS (RECOMMENDED)		
	CPU	RAM	FREE HDD SPACE
Mac OS X 10.5	<ul style="list-style-type: none"> Intel® Processors 867 MHz or faster Power PC G4/ G5 	512 MB (1 GB)	1 GB
Mac OS X 10.6	<ul style="list-style-type: none"> Intel® Processors 	1 GB (2 GB)	1 GB

Linux

ITEM	REQUIREMENTS
Operating system	RedHat® Enterprise Linux WS 4, 5 (32/64 bit) Fedora 4, 5, 6, 7, 8, 9, 10, 11, 12 (32/64 bit) SuSE Linux 10.0, 10.1 (32 bit) OpenSuSE® 10.2, 10.3, 11.0, 11.1, 11.2 (32.64 bit) Mandriva 2005, 2006, 2007, 2008, 2009, 2009.1 (32/64 bit) Ubuntu 5.04, 5.10, 6.06, 6.10, 7.04, 7.10, 8.04, 8.10, 9.04, 9.10 (32/64 bit) SuSE Linux Enterprise Desktop 10, 11 (32/64 bit) Debian 4.0, 5.0 (32/64 bit)
CPU	Pentium IV 2.4 GHz (Intel Core™ 2)
RAM	512 MB (1 GB)
Free HDD space	1 GB (2 GB)

INSTALLING USB CONNECTED MACHINE'S DRIVER

A locally connected machine is a machine directly connected to your computer by a USB cable.

- Only use a USB cable no longer than 3 m (10 ft.).

Windows

You can install the machine software using the typical or custom method. The following steps are recommended for most users who use a machine directly connected to your computer. All components necessary for machine operations will be installed.

- Make sure that the machine is connected to the computer and powered on.
 - If the “**Found New Hardware Wizard**” window appears during the installation procedure, click **Cancel** to close the window.
- Insert the supplied software CD into your CD-ROM drive.
 - The software CD should automatically run and an installation window will appear.
 - If the installation window does not appear, click **Start** and then **Run**. Type **X:\Setup.exe**, replacing “X” with the letter which represents your CD-ROM Drive. Click **OK**.
 - If you use Windows Vista, Windows 7 or Windows 2008 Server R2 click **Start > All programs > Accessories > Run**.

Type **X:\Setup.exe** replacing “X” with the letter which represents your CD-ROM Drive and click **OK**.

- If the **AutoPlay** window appears in Windows Vista, Windows 7 or Windows 2008 Server R2, click **Run Setup.exe** in **Install or run program** field, and click **Continue** or **Yes** in the **User Account Control** window.
- Select **Install now**.

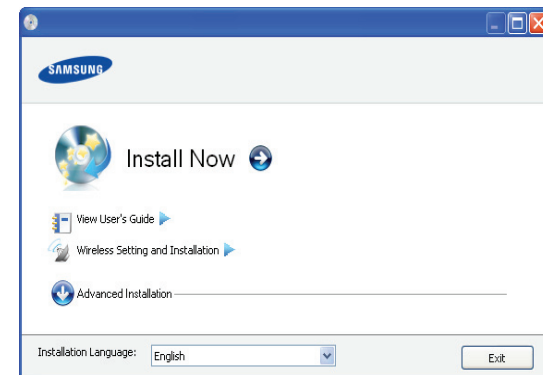

If necessary, select a language from the drop-down list.

- For SCX-3205W(K), you can access the **Wireless Setting and Installation** menu. The menu allows you to install a wireless network to connect to the machine with a USB cable (See “Wireless network setup (SCX-3205W(K))” on page 36).
- The **Advanced Installation** has two options, **Custom Installation** and **Install Software Only**. The **Custom Installation** allows you to select the machine’s connection and choose individual component to install. The **Install Software Only** allows you to install the supplied software, such as Smart Panel. Follow the instruction on the window.

- Read the **License Agreement**, and select **I accept the terms of the License Agreement**. Then, click **Next**.

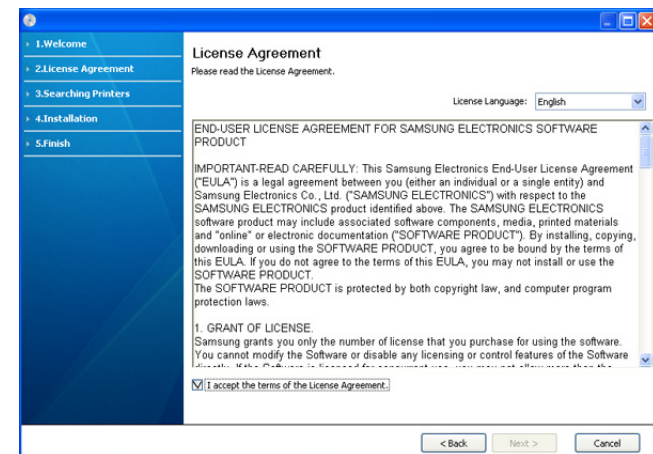

The software searches for the machine.

- If your machine is not connected to the computer, the following

window will appear.

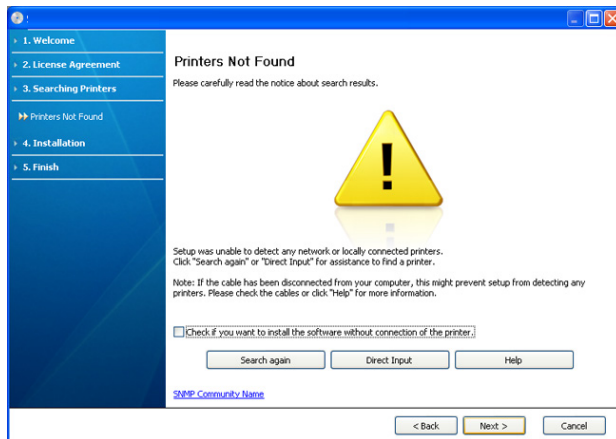

- After connecting the machine, click **Next**.
 - **Check if you want to install the software without connection of the printer.**
 - Check this option to install the software without a machine connected. In this case, the print a test page window will be skipped, and completes the installation.
 - **Search again**

When you press this button, the firewall notice window appears.

 - Turn off the firewall and **Search again**. For Windows operating system, click **Start > Control Panel > Windows Firewall**, and inactivate this option.
 - Turn off the firewall from the third party's program beside the operating system. Refer to the manual provided by individual programs.
 - **Direct Input**

The **Direct Input** allows you to search a specific machine on the network.

 - **Search by IP address:** Enter the IP address or the host name. Then click **Next**.

To verify your machine's IP address, print a network configuration report (See "Printing a network configuration report" on page 30).
 - **Search by network path:** To find a shared machine (UNC Path), enter the shared name manually or find a shared printer by clicking the **Browse** button. Then click **Next**.
 - **Help**
 - This help button gives you the detailed information about how to connect the machine.
5. The searched machines will be shown on the screen. Select the one you wish to use and click **Next**.



If the software searched only one machine, the confirmation window appears.

6. After the installation is finished, a window asking you to print a test page appears. If you want to print a test page, click **Print a test page**. Otherwise, just click **Next** and skip to step 8.
7. If the test page prints out correctly, click **Yes**. If not, click **No** to reprint it.
8. If you want to register your machine on Samsung web site, click **On-line Registration**.



If your machine is not connected yet to the network or computer, click **How to connect?**. **How to connect?** gives detailed information about how to connect the machine. Follow the instructions in the window.

9. Click **Finish**.



- If the printer driver does not work properly, follow the steps below to repair or reinstall the driver.
- a) Make sure that the machine is connected to your machine and powered on.
 - b) From the **Start** menu, select **Programs** or **All Programs > Samsung Printers > your printer driver name > Uninstall**.
 - c) Select the option you wish to execute, then follow the instruction on the window.

Macintosh

1. Make sure that the machine is connected to your computer and powered on.
2. Insert the supplied software CD into your CD-ROM drive.
3. Double-click the CD-ROM icon that appears on your Macintosh desktop.
4. Double-click the **MAC_Installer** folder.
5. Double-click the **Installer OS X** icon.
6. Enter the password and click **OK**.
7. The Samsung Installer window opens. Click **Continue**.
8. Read the license agreement and click **Continue**.
9. Click **Agree** to agree to the license agreement.
10. Select **Easy Install** and click **Install**. **Easy Install** is recommended for most users. All components necessary for machine operations will be installed.

If you select **Custom Install**, you can choose individual components to install.
11. When the message which warns that all applications will close on your computer appears, click **Continue**.
12. Select **Typical installation for a network printer** for a network printer and then click **OK**.
13. After the installation is finished, click **Restart**.
14. Open the **Applications** folder > **Utilities** > **Print Setup Utility**.
 - For Mac OS X 10.5 ~ 10.6, open the **Applications** folder > **System Preferences** and click **Print & Fax**.
15. Click **Add** on the **Printer List**.
 - For Mac OS X 10.5 ~ 10.6, click the "+" icon; a display window will pop up.
16. For Mac OS X 10.3, select the **USB** tab.
 - For Mac OS X 10.4, click **Default Browser** and find the USB connection.
 - For Mac OS X 10.5 ~ 10.6, click **Default** and find the USB connection.
17. For Mac OS X 10.3, if Auto Select does not work properly, select **Samsung in Printer Model** and your machine name in **Model Name**.
 - For Mac OS X 10.4, if Auto Select does not work properly, select **Samsung in Print Using** and your machine name in **Model**.
 - For Mac OS X 10.5 ~ 10.6, if Auto Select does not work properly, select **Select a driver to use...** and your machine name in **Print Using**.

Your machine appears on the **Printer List**, and is set as the default machine.
18. Click **Add**.

 If the printer driver does not work properly, uninstall the driver and reinstall it.

Follow steps below to uninstall the driver for Macintosh.

- a) Make sure that the machine is connected to your computer and powered on.
- b) Insert the supplied software CD into your CD-ROM drive.
- c) Double-click CD-ROM icon that appears on your Macintosh desktop.
- d) Double-click the **MAC_Installer** folder.
- e) Double-click the **Installer OS X** icon.
- f) Enter the password and click **OK**.
- g) The Samsung Installer window opens. Click **Continue**.
- h) Read the license agreement and click **Continue**.
- i) Click **Agree** to agree to the license agreement.
- j) Select **Uninstall** and click **Uninstall**.
- k) When the message which warns that all applications will close on your computer appears, Click **Continue**.
- l) When the uninstall is done, click **Quit**.

Linux

You need to download Linux software packages from the Samsung website to install the printer software.

Follow the steps below to install the software.

Installing the Unified Linux Driver

1. Make sure that the machine is connected to your computer and powered on.
2. When the **Administrator Login** window appears, type in root in the **Login** field and enter the system password.

 You must log in as a super user (root) to install the machine software. If you are not a super user, ask your system administrator.

3. From the Samsung website, download the Unified Linux Driver package to your computer.
4. Right-click the **Unified Linux Driver** package and extract the package.
5. Double-click **cdroot > autorun**.
6. When the welcome screen appears, click **Next**.

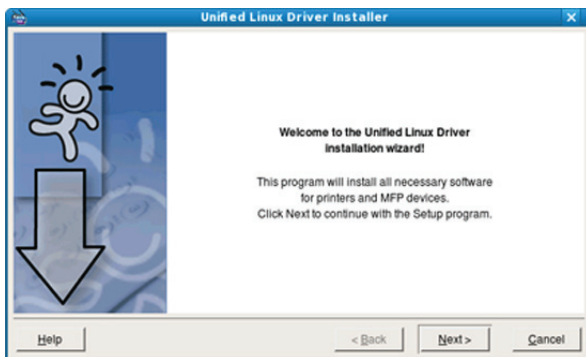

7. When the installation is complete, click **Finish**.

The installation program added the Unified Driver Configurator desktop icon and the Unified Driver group to the system menu for your convenience. If you have any difficulties, consult the on screen help that is available through your system menu or from the driver package Windows applications, such as **Unified Driver Configurator**.

Installing the Smart Panel

1. Make sure that the machine is connected to your computer and powered on.
2. When the **Administrator Login** window appears, type in root in the **Login** field and enter the system password.

 You must log in as a super user (root) to install the machine software. If you are not a super user, ask your system administrator.

3. From the Samsung website, download the **Smart Panel** package to your computer.
4. Right-click the Smart Panel package and extract the package.
5. Double-click **cdroot > Linux > smartpanel > install.sh**.

Installing the Printer Settings Utility

1. Make sure that the machine is connected to your computer and powered on.
2. When the **Administrator Login** window appears, type in root in the **Login** field and enter the system password.

 You must log in as a super user (root) to install the machine software. If you are not a super user, ask your system administrator.

3. From the Samsung website, download the Printer Settings Utility package to your computer.
4. Right-click the **Printer Settings Utility** package and extract the package.
5. Double-click **cdroot > Linux > psu > install.sh**.

 If the printer driver does not work properly, uninstall the driver and reinstall it.

Follow the steps below steps to uninstall the driver for Linux.

- a) Make sure that the machine is connected to your computer and powered on.
- b) When the **Administrator Login** window appears, type in "root" in the **Login** field and enter the system password.
You must log in as a super user (root) to uninstall the printer driver. If you are not a super user, ask your system administrator.
- c) Click the icon at the bottom of the desktop. When the Terminal screen appears, type in:

```
[root@localhost root]#cd /opt/Samsung/mfp/uninstall/
[root@localhost uninstall]#./uninstall.sh
```
- d) Click **Uninstall**.
- e) Click **Next**.
- f) Click **Finish**.

SHARING YOUR MACHINE LOCALLY

Follow the steps below to set up computers to share your machine locally. If the Host computer is directly connected to the machine by a USB cable and is also connected to the local network environment, the client computer connected to the local network can use the shared machine through the host computer to print.

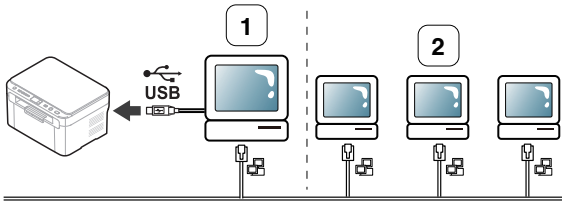

1	Host computer	A computer which is directly connected to the machine by USB cable.
2	Client computers	Computers which use the machine shared through the host computer.

Windows

Setting up a host computer

1. Install your printer driver (See "Installing USB connected machine's driver" on page 26).
2. Click the Windows **Start** menu.
3. For Windows 2000, select **Settings > Printers**.
 - For Windows XP/Server 2003, select **Printers and Faxes**.
 - For Windows Server 2008/Vista, select **Control Panel > Hardware and Sound > Printers**.
 - For Windows 7, select **Control Panel > Hardware and Sound > Devices and Printers**.
 - For Windows Server 2008 R2, select **Control Panel > Hardware > Devices and Printers**.
4. Right-click the printer icon.
5. For Windows XP/Vista/Server 2003/Server 2008, press **Properties**.
For Windows 7/Windows Server 2008 R2, from context menus, select the **Printer properties**.

 If **Printer properties** item has a ► mark, you can select other printer drivers connected with the selected printer.

6. Select the **Sharing** tab.

 If you are a Windows 7/Windows Server 2008 R2 user, check the **Change Sharing Options**.

7. Check the **Share this printer** checkbox.
8. Fill in the **Share Name** field. Click **OK**.

Setting up a client computer

1. Install your printer driver (See "Installing USB connected machine's driver" on page 26).
2. Click the Windows **Start** menu.
3. Select **All programs > Accessories > Windows Explorer**.
4. Enter the IP address of the host computer in the address bar and press Enter in your keyboard.



 In case host computer requires a **User name** and **Password**, fill in User ID and password of the host computer account.

5. Right-click the printer icon you want to share and select **Connect**.
6. If a set up complete message appears, click **OK**.
7. Open the file you want to print and start printing.

Macintosh

 The following steps are for Mac OS X 10.5~10.6. Refer to Mac Help for other OS versions.

Setting up a host computer

1. Install your printer driver (See "Macintosh" on page 27).
2. Open the **Applications** folder > **System Preferences** and click **Print & Fax**.
3. Select the printer to share in the **Printers list**.
4. Select **Share this printer**.

Setting up a client computer

1. Install your printer driver (See "Macintosh" on page 27).
2. Open the **Applications** folder > **System Preferences** and click **Print & Fax**.
3. Click the "+" icon.
A display window showing the name of your shared printer appears.
4. Select your machine and click **Add**.

network setup (scx-3205w(k) only)

This chapter gives you step-by-step instructions for setting up the network connected machine and software.

This chapter includes:

- Network environment
- Introducing useful network programs
- Using a wired network

NETWORK ENVIRONMENT

You need to set up the network protocols on the machine to use it as your network machine. You can set up the basic network settings through the network setting programs.

The following table shows the network environments supported by the machine.

ITEM	REQUIREMENTS
Network interface	<ul style="list-style-type: none">• Ethernet 10/100 Base-TX• 802.11b/g/n Wireless LAN^a
Network operating system	<ul style="list-style-type: none">• Windows 2000/Server 2003 /Server 2008/XP/Vista/7/Server 2008 R2• Various Linux OS• Mac OS X 10.3 ~ 10.6
Network protocols	<ul style="list-style-type: none">• TCP/IPv4• DHCP, BOOTP• DNS, WINS, Bonjour, SLP, UPnP• Standard TCP/IP Printing (RAW), LPR, IPP• SNMPv 1/2/3, HTTP• TCP/IPv6 (DHCP, DNS, RAW, LPR, SNMPv 1/2/3, HTTP) (See "IPv6 Configuration" on page 34.)
Wireless security	<ul style="list-style-type: none">• Authentication: Open System, Shared Key, WPA Personal, WPA2 Personal (PSK)• Encryption: WEP64, WEP128, TKIP, AES

a. Depending on your country, wireless LAN card may not be available. For some counties, only 802.11 b/g can be applied. Contact your local Samsung dealer or the retailer where you bought your machine.

INTRODUCING USEFUL NETWORK PROGRAMS

There are several programs available to setup the network settings easily in network environment. For the network administrator especially, managing several machines on the network is possible.

 Before using the programs below, set the IP address first.

- Installing network connected machine's driver
- IPv6 Configuration

SyncThru™ Web Service

Web server embedded on your network machine, which allows you to do the following tasks.

- You can configure the network parameters necessary for the machine to connect to various network environments.
- You can customize machine settings
(See "Using SyncThru™ Web Service (SCX-3205W(K) only)" on page 69).

SyncThru™ Web Admin Service

Web-based machine management solution for network administrator.

SyncThru™ Web Admin Service provides you with an efficient way of managing network devices and lets you remotely monitor and troubleshoot network machines from any site with corporate internet access.

- Download this program from <http://solution.samsungprinter.com>.

SetIP

This utility program allows you to select a network interface and manually configure the IP addresses for use with the TCP/IP protocol.

- See "IPv4 setting using SetIP Program (Windows)" on page 31.
- See "IPv4 setting using SetIP Program (Macintosh)" on page 31.
- See "IPv4 setting using SetIP Program (Linux)" on page 32.

 TCP/IPv6 is not supported by this program.

USING A WIRED NETWORK

You must set up the network protocols on your machine to use it on your network. This chapter will show you how this is easily accomplished.

You can use network after connecting network cable to a corresponding port on your machine.

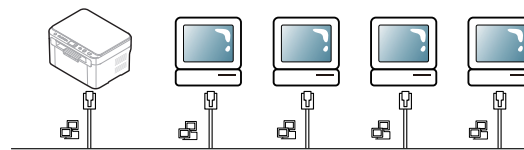

Printing a network configuration report

You can print a **network configuration report** from the machine's control panel that will show the current machine's network settings. This will help you to set up a network and troubleshoot problems.

1. Press and hold  **Stop/Clear** button on the control panel for long enough (about four seconds) until the **Status LED** blinks fast.
2. Then, release the button.

Using this **Network Configuration Report**, you can find your machine MAC address and IP address.

For example:

- MAC Address:00:15:99:41:A2:78
- IP Address:192.0.0.192

Setting IP address

First, you have to set up an IP address for network printing and managements. In most cases a new IP address will be automatically assigned by a DHCP (Dynamic Host Configuration Protocol) server located on the network.

In a few situations the IP address must be set manually. This is called a static IP and is often required in corporate Intranets for security reasons.

- **DHCP IP assignment:** Connect your machine to the network, and wait a few minutes for the DHCP server to assign an IP address to the machine. Then, print the **Network Configuration Report** as explained above. If the report shows that the IP address has changed, the assignment was successful. You will see the new IP address in the report.
- **Static IP assignment:** Use SetIP program to change the IP address from your computer. If your machine has a control panel, you can also change IP address using the machine's control panel.

In an office environment, we recommend that you contact a network administrator to set IP address for you.

IPv4 setting using SetIP Program (Windows)

This program is for manually setting the network IP address of your machine using its MAC address to communicate with the machine. A MAC address is the hardware serial number of the network interface and can be found in the **Network Configuration Report**.

Before using SetIP program, disable the computer firewall by performing the following steps.

1. Open **Control Panel**.
2. Double-click **Security Center**.
3. Click **Windows Firewall**.
4. Disable the firewall.

Installing the program

1. Insert the Printer Software CD-ROM provided with your machine. When the driver CD runs automatically, close that window.
2. Start Windows Explorer and open the X drive (X represents your CD-ROM drive).
3. Double-click **Application > SetIP**.
4. Double-click **Setup.exe** to install this program.
5. Select a language, then click **Next**.
6. Follow the instructions in the window and complete the installation.

Starting the program

1. Connect your machine to the network with a network cable.
2. Turn on the machine.
3. From the Windows **Start** menu, select **All Programs > Samsung Printers > SetIP > SetIP**.
4. Click on the  icon (third from left) in the SetIP window to open the TCP/IP configuration window.

5. Enter the machine's new information into the configuration window as follows. In a corporate intranet, you may need to have this information assigned by a network manager before proceeding.

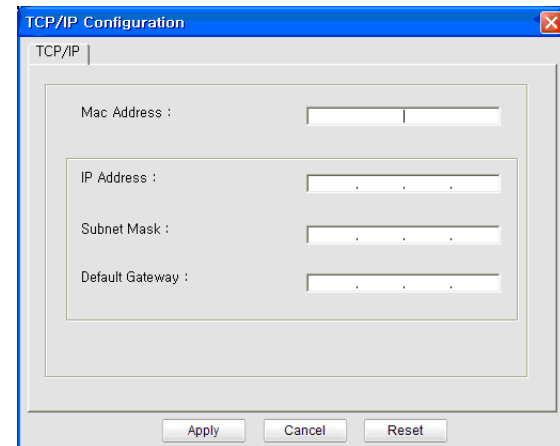

- **MAC Address:** Find the machine's MAC address from the **Network Configuration Report** and enter it without the colons. For example, 00:15:99:29:51:A8 becomes 0015992951A8.
 - **IP Address:** Enter a new IP address for your printer. For example, if your computer's IP address is 192.168.1.150, enter 192.168.1.X (X is number between 1 and 254 other than the computer's address).
 - **Subnet Mask:** Enter a Subnet Mask.
 - **Default Gateway:** Enter a Default Gateway.
6. Click **Apply**, and then click **OK**. The machine will automatically print the **Network Configuration Report**. Confirm that all the settings are correct.
 7. Click **Exit** to close the SetIP program.
 8. If necessary, restart the computer's firewall.

IPv4 setting using SetIP Program (Macintosh)

For using SetIP program, disable the computer firewall before continuing by performing the following.

1. Open **System Preferences**.
2. Click **Security**.
3. Click the **Firewall** menu.
4. Turn firewall off.

 The following instructions may vary from your model.

1. Connect your machine to the network with a network cable.
2. Insert the Installation CD-ROM, and open the disk window, select **MAC_Installer > MAC_Printer > SetIP > SetIP.ppplet.html**.
3. Double-click the file and **Safari** will automatically open, then select **Trust**. The browser will open the **SetIP.ppplet.html** page that shows the printer's name and IP address information.
4. Click on the  icon (third from left) in the SetIP window to open the TCP/IP configuration window.
5. Enter the machine's new information into the configuration window as follows. In a corporate intranet, you may need to have this information assigned by a network manager before proceeding.
 - **MAC Address:** Find the machine's MAC address from the **Network Configuration Report** and enter it without the colons. For example, 00:15:99:29:51:A8 becomes 0015992951A8.
 - **IP Address:** Enter a new IP address for your printer.

For example, if your computer's IP address is 192.168.1.150, enter 192.168.1.X (X is number between 1 and 254 other than the computer's address).

- **Subnet Mask:** Enter a Subnet Mask.
 - **Default Gateway:** Enter a Default Gateway.
6. Select **Apply**, then **OK**, and **OK** again. The printer will automatically print the configuration report. Confirm that all the settings are correct. **Quit Safari.** You may close and eject the installation CD-ROM. If necessary, restart the computer's firewall. You have successfully changed the IP address, subnet mask, and gateway.

IPv4 setting using SetIP Program (Linux)

SetIP program should be automatically installed during the printer driver installation.

1. Print the machine's network configuration report to find your machine's MAC address.
2. Open the `/opt/Samsung/mfp/share/utils/`.
3. Double-click the **SetIPApplet.html** file.
4. Click to open the TCP/IP configuration window.
5. Enter the network card's MAC address, IP address, subnet mask, default gateway, and then click **Apply**.
 When you enter the MAC address, enter it without a colon(:).
6. The machine prints the network information. Confirm all the settings are correct.
7. Close the SetIP program.

Network parameter setting

You can also set up the various network settings through the network administration programs such as **SyncThru™ Web Admin Service** and **SyncThru™ Web Service**.

Restoring factory default settings

You may need to reset the machine to the factory default settings when machine that you are using is connected to new network environment.

Restoring factory default settings using SyncThru™ Web Service

1. Start a web browser such as Internet Explorer, Safari or Firefox and enter your machine's new IP address in the browser window.
For example:

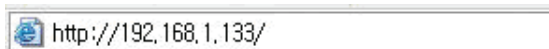
 `http://192.168.1.133/`

2. Click **Go** to access the SyncThru™ Web Service.
3. Click **Login** on the upper right of the website.
The **Login** window appears.
4. Type in the **ID** and **Password**, and then click **Login**.
If it is your first time logging into SyncThru™ Web Service, type in the below default ID and password.
 - **ID:** admin
 - **Password:** sec00000
5. Click **Settings > Network Settings**.
6. Click **Restore Default** on the left pane of the website.
7. Click **Clear**.
8. Click **Yes** when the confirmation window appears.
9. Click **OK** when the success window appears.
10. Turn off and restart machine to apply settings.

INSTALLING NETWORK CONNECTED MACHINE'S DRIVER

Windows

You can set up the machine driver, follow the steps below.

This is recommended for most users. All components necessary for machine operations will be installed.

1. Make sure that the machine is connected to the network or USB and powered on.
2. Insert the supplied software CD into your CD-ROM drive.
 - The software CD should automatically run and an installation window appears.
 - If the installation window does not appear, click **Start** and then **Run**. Type `X:\Setup.exe`, replacing "X" with the letter which represents your CD-ROM drive. Click **OK**.
 - If you use Windows Vista, Windows 7 or Windows 2008 Server R2 click **Start > All programs > Accessories > Run**. Type `X:\Setup.exe` replacing "X" with the letter which represents your CD-ROM drive and click **OK**.
 - If the **AutoPlay** window appears in Windows Vista, click **Run Setup.exe** in **Install or run program** field, and click **Continue** in the **User Account Control** windows.
 - If the **AutoPlay** window appears in Windows 7 or Windows 2008 Server R2, click **Run Setup.exe** in **Install or run program** field, and click **Yes** in the **User Account Control** windows.
3. Select **Install Now**.

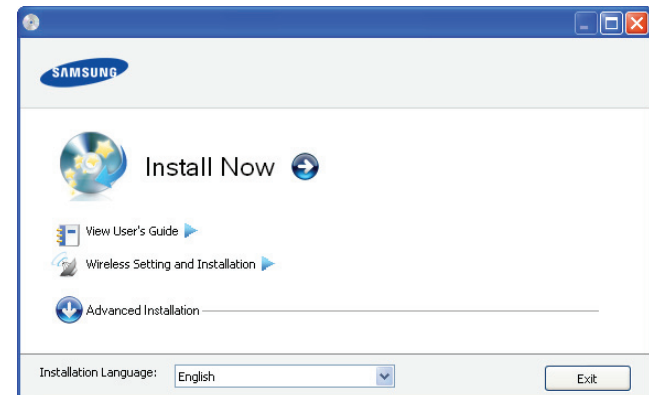

If necessary, select a language from the drop-down list.

- For SCX-3205W(K), you can access **Wireless Setting and Installation** menu. The **Wireless Setting and Installation** allows you to install a wireless network to connect to the machine with a USB cable (See "Setting a wireless network with USB cable" on page 38).
 - The **Advanced Installation** has two options, **Custom Installation** and **Install Software Only**. The **Custom Installation** allows you to select the machine's connection and choose individual component to install. The **Install Software Only** allows you to install the supplied software such as the Smart Panel. Follow the instruction on the window.
4. Read **License Agreement**, and select **I accept the terms of the License Agreement**. Then, click **Next**.
The program searches for the machine.
 If your machine is not found in the network or locally, the error

message appears.

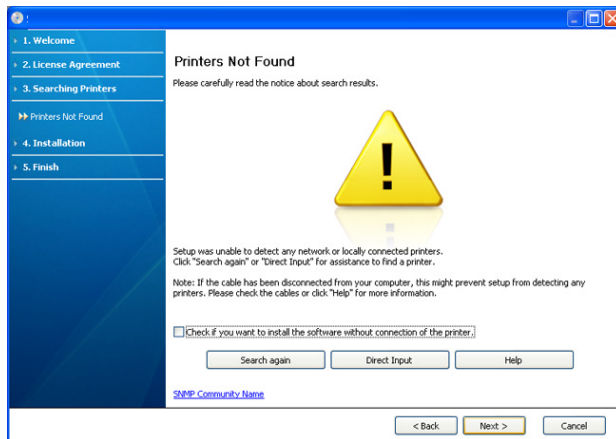

- **Check if you want to install the software without connection of the printer.**
 - Check this option to install this program without a machine connected. In this case, the print a test page window will be skipped, and completes the installation.
 - **Search again**

When you press this button, the firewall notice window appears.

 - Turn off the firewall and **Search again**. For Windows operating system, click **Start > Control Panel > Windows Firewall**, and inactivate this option.
 - Turn off the firewall from the third party's program beside the operating system. Refer to the manual provided by individual programs.
 - **Direct Input**

The **Direct Input** allows you to search a specific machine on the network.

 - **Search by IP address:** Enter the IP address or the host name. Then click **Next**.

To verify your machine's IP address, print a network configuration report (See "Printing a network configuration report" on page 30).
 - **Search by network path:** To find a shared machine (UNC Path), enter the shared name manually or find a shared printer by clicking the **Browse** button. Then click **Next**.
 - **Help**

If your machine is not connected to the computer or network, this help button gives detailed information about the how to connect the machine.
5. The searched machine will be shown on the screen. Select the one you wish to use and click **Next**.
 -  If the driver searched only one machine, the confirmation window appears.
 6. After the installation is finished, a window asking you to print a test page appears. If you want to print a test page, click **Print a test page**. Otherwise, just click **Next** and go to step 8.
 7. If the test page prints out correctly, click **Yes**.

If not, click **No** to reprint it.
 8. If you want to register your machine on Samsung website, click **On-line Registration**.

 If your machine is not connected yet to the network, click **How to connect?**. **How to connect?** gives you the detailed information about the how to connect the machine. Follow the instructions in the window.

9. Click **Finish**.

-  • After the driver setup is completed, you may enable firewall.
- If your printer driver does not work properly, follow the step below to repair or reinstall the driver.
 - a) Make sure that the machine is connected to your machine and powered on.
 - b) From the **Start** menu, select **Programs** or **All Programs > Samsung Printers > your printer driver name > Uninstall**.
 - c) Select the option as you wish, follow the instruction on the window.

Macintosh

1. Make sure that the machine is connected to your network and powered on. Also, your machine's IP address should have been set.
2. Insert the supplied software CD into your CD-ROM drive.
3. Double-click the CD-ROM icon that appears on your Macintosh desktop.
4. Double-click the **MAC_Installer** folder.
5. Double-click the **Installer OS X** icon.
6. Enter the password and click **OK**.
7. The Samsung Installer window opens. Click **Continue**.
8. Read the license agreement and click **Continue**.
9. Click **Agree** to agree to the license agreement.
10. Select **Easy Install** and click **Install**. **Easy Install** is recommended for most users. All components necessary for machine operations will be installed.

If you select **Custom Install**, you can choose individual components to install.
11. When the message which warns that all applications will close on your computer appears. Click **Continue**.
12. Select **Typical installation for a network printer** for a network printer and then click **OK**.
13. The SetIP program automatically runs. If the machine has already configured network information, close the SetIP program.
14. Click **OK** to continue the installation.
15. After the installation is finished, click **Restart**.
16. Open the **Applications** folder > **Utilities > Print Setup Utility**.
 - For Mac OS X 10.5~10.6, open the **Applications** folder > **System Preferences** and click **Print & Fax**.
17. Click **Add** on the **Printer List**.
 - For Mac OS X 10.5~10.6, click the "+" icon. A display window will pop up.
18. For Mac OS X 10.3, select the **IP Printing** tab.
 - For Mac OS X 10.4, click **IP Printer**.
 - For Mac OS X 10.5~10.6, click **IP**.
19. Select **HP Jetdirect - Socket** in **Protocol**.
 -  When printing a document containing many pages, printing performance may be enhanced by choosing **Socket** for **Printer Type** option.
20. Enter the machine's IP address in the **Address** input field.

21. Enter the queue name in the **Queue** input field. If you cannot determine the queue name for your machine server, try using the default queue first.
22. For Mac OS X 10.3, if Auto Select does not work properly, select **Samsung** in **Printer Model** and your machine name in **Model Name**.
 - For Mac OS X 10.4, if Auto Select does not work properly, select **Samsung** in **Print Using** and your machine name in **Model**.
 - For Mac OS X 10.5~10.6, if Auto Select does not work properly, choose **Select Printer Software** and your machine name in **Print Using**.

Your machine appears on the **Printer List**, and is set as the default machine.

23. Click **Add**.



If the printer driver does not work properly, uninstall the driver and reinstall it.

Follow steps below to uninstall the driver for Macintosh.

- a) Make sure that the machine is connected to your computer and powered on.
- b) Insert the supplied software CD into your CD-ROM drive.
- c) Double-click CD-ROM icon that appears on your Macintosh desktop.
- d) Double-click the **MAC_Installer** folder.
- e) Double-click the **Installer OS X** icon.
- f) Enter the password and click **OK**.
- g) The Samsung Installer window opens. Click **Continue**.
- h) Read the license agreement and click **Continue**.
- i) Click **Agree** to agree to the license agreement.
- j) Select **Uninstall** and click **Uninstall**.
- k) When the message which warns that all applications will close on your computer appears, click **Continue**.
- l) When the uninstall is done, click **Quit**.

Linux

Install Linux Driver and add network Printer

1. Make sure that the machine is connected to your network and powered on. Also, your machine's IP address should have been set.
2. Download the Unified Linux Driver package from the Samsung website.
3. Extract the UnifiedLinuxDriver.tar.gz file and open the new directory.
4. Double-click the **Linux** folder.
5. Double-click the **install.sh** icon.
6. The Samsung Installer window opens. Click **Continue**.
7. The Add printer wizard window opens. Click **Next**.
8. Select Network printer and click **Search** button.
9. The Printer's IP address and model name appears on list field.
10. Select your machine and click **Next**.
11. Input the printer description and Next
12. When the add printer is done, click Finish
13. When the install is done, click Finish

Add network Printer

1. Double-click the **Unified Driver Configurator**.
2. Click **Add Printer...**
3. The **Add printer wizard** window opens. Click **Next**.
4. Select **Network printer** and click the **Search** button.

5. The printer's IP address and model name appears on list field.
6. Select your machine and click **Next**.
7. Input the printer description and **Next**
8. When the add printer is done, click **Finish**.

IPv6 CONFIGURATION



TCP/IPv6 is supported properly only in Windows Vista or higher.



If the IPv6 network seems to not be working, set all the network setting to the factory defaults and try again (See "Restoring factory default settings" on page 32).

In the IPv6 network environment, follow the next procedure to use the IPv6 address.

1. Connect your machine to the network with a network cable.
2. Turn on the machine.
3. Print a **Network Configuration Report** from the machine's control panel that will check IPv6 addresses (See "Printing a network configuration report" on page 30).
4. Select **Start > Control Panel > Hardware and Sound > Printer > Add Printer**.
5. Click **Add a local printer** on the **Add Printer** windows.
6. Follow the instruction on the window.
7. The **Add Printer Wizard** window appears. Follow the instruction on the window.



If the machine does not work in the network environment, activate IPv6. Refer to the next section followed by.

Printing a network configuration report

You can print a **network configuration report** from the machine's control panel that will show the current machine's network settings. This will help you to set up a network and troubleshoot problems.

1. In ready mode, press and hold  **Stop/Clear** button on the control panel for long enough (about four seconds) until the **Status LED** blinks fast.
2. Then, release the button.

Using this **Network Configuration Report**, you can find your machine MAC address and IP address.

For example:

- MAC Address:00:15:99:41:A2:78
- IP Address:192.0.0.192

Setting IPv6 addresses

Machine supports the following IPv6 addresses for network printing and managements.

- **Link-local Address:** Self-configured local IPv6 address (Address starts with FE80).
- **Stateless Address:** Automatically configured IPv6 address by a network router.
- **Stateful Address:** IPv6 address configured by a DHCPv6 server.
- **Manual Address:** Manually configured IPv6 address by a user.

Manual address configuration

1. Start a web browser such as Internet Explorer that supports IPv6 addressing as a URL (See "Using SyncThru™ Web Service (SCX-3205W(K) only)" on page 69).



For IPv4, enter the IPv4 address (http://xxx.xxx.xxx.xxx) in the address field and press the Enter key or click **Go**.

2. When the **SyncThru™ Web Service** window opens, click **Network Settings**.
3. Click **TCP/IPv6**.
4. Enable the **Manual Address** In the **TCP/IPv6** section.
5. Select the **Address/Prefix** and click the **Add** button, then the router prefix will automatically be entered into the address field.
Enter the rest of address. (ex: 3FFE:10:88:194::AAAA. "A" is the hexadecimal 0 through 9, A through F.)
6. Click the **Apply** button.

Installing printer driver

Driver installation for network printer in IPv6 network environment is same as TCP/IPv4 (See "Installing network connected machine's driver" on page 32).

Select TCP/IP Port and when the list of machines are displayed, simply select your machine's IPv6 address.

Using SyncThru™ Web Service

1. Start a web browser such as Internet Explorer that supports IPv6 addressing as a URL.
2. Select one of the IPv6 addresses (**Link-local Address, Stateless Address, Stateful Address, Manual Address**) from **Network Configuration Report** (See "Printing a network configuration report" on page 30).
3. Enter the IPv6 addresses (ex: http://[FE80::215:99FF:FE66:7701]).



Address must be enclosed in '[']' brackets.

wireless network setup (scx-3205w(k))

This chapter gives you step-by-step instructions for setting up the wireless network connected machine and software.

This chapter includes:

- Setting a wireless network with the WPS button
- Using a wireless network from the computer
- Setting a wireless network with USB cable

 For more information about the network environment, network programs, and installing network connected machine's driver, refer to the following chapters.

- See "Network environment" on page 30.
- See "Introducing useful network programs" on page 30.
- See "Installing network connected machine's driver" on page 32.

SETTING A WIRELESS NETWORK WITH THE WPS BUTTON

You can install a wireless network with the **WPS** () button.

 After completing the wireless network connection, you need to install a machine driver to print from an application (See "Installing network connected machine's driver" on page 32).

Setting a wireless network with the WPS button

If your machine and an access point (or wireless router) support Wi-Fi Protected Setup™ (WPS), you can easily configure the wireless network settings by pressing the **WPS** () button on the control panel.

 If you want to use the wireless network using the infrastructure mode, make sure that the network cable is disconnected from the machine. Using the **WPS (PBC)** button or entering the PIN number from the computer to connect to the Access Point varies depending on the access point (or wireless router) you are using. Refer to the user's guide of the access point (or wireless router) you are using.

Items to prepare

You need to ensure you have the following items ready to use:

- Check if the access point (or wireless router) supports Wi-Fi Protected Setup™ (WPS).
- Check if your machine supports Wi-Fi Protected Setup™ (WPS).
- Networked computer (PIN mode only)

 Refer to your network administrator, or the person that set up your wireless network, for information about your network configuration.

Choosing your network connection

There are two methods to connect your machine to a wireless network using the **WPS** () button on the control panel.

The **Push Button Configuration (PBC)** method allows you to connect your machine to a wireless network by pressing both the **WPS** () button on the control panel of your machine and the **WPS (PBC)** button on a Wi-Fi Protected Setup™ (WPS)-enabled access point (or wireless router) respectively.

- Setting a wireless network with network cable
- Completing the installation
- Troubleshooting

The **Personal Identification Number (PIN)** method helps you connect your machine to a wireless network by entering the supplied PIN information on a Wi-Fi Protected Setup™ (WPS)-enabled access point (or wireless router).

Factory default in your machine is **PBC** mode, which is recommended for a typical wireless network environment.

Connecting to a wireless network in PBC mode

To connect your machine to the wireless network in PBC mode, follow the following steps:



You need to check the status of the wireless LED.

1. Press and hold the **WPS** () button on the control panel for about 2 - 4 seconds until the status LED blinks quickly.

-  : The light blinks slowly on wireless LED. The machine starts connecting to the wireless network. The LED blinks slowly for up to two minutes until you press the PBC button on access point (or wireless router).

2.  : Press the **WPS (PBC)** button on the access point (or wireless router).

The wireless LED blinks in the order below:

- a)  : The light blinks fast on the wireless LED. The machine is connecting to the access point (or wireless router).
- b)  : When the machine is successfully connected to the wireless network, the wireless LED light stays on.

Connecting to the wireless network in PIN mode

To connect your machine to the wireless network, follow the following steps:

You need to check the status of the wireless LED.

1. The network configuration report including PIN number must be printed.

In ready mode, press and hold the  **Stop/Clear** button on the control panel for about 5 seconds. You can find your machine's PIN number.

2. Press and hold the **WPS** () button on the control panel for more than 4 seconds until the status LED on.

-  : The light blinks slowly on the wireless LED. The machine starts connecting to access point (or wireless router).

3. You need to enter eight-digit PIN number within two minutes to the computer which is connected to the access point (or wireless router). The LED blinks slowly for up to two minutes until you enter the eight-digit PIN number

The wireless LED blinks in the order below:

- a)  : The light blinks fast on the wireless LED. The machine is

connecting to the access point (or wireless router).

- b)  : When the machine is successfully connected to the wireless network, the wireless LED light stays on.

Re-connecting to the wireless network

When the wireless function is off, the machine automatically tries to re-connect to the access point (or wireless router) with the previously used wireless connection settings and address.

 In the following cases, the machine automatically re-connects to the wireless network:

- The machine is turned off and on again.
- The access point (or wireless router) is turned off and on again.



Canceling a wireless network connection process

To cancel the wireless network connection function when the machine is connecting to the wireless network, press and release the  **Stop/Clear** button on the control panel. **You need to wait 2 minutes to re-connect the wireless network.**

Disconnecting a wireless network connection

To disconnect the wireless network connection, press the **WPS** () button on the control panel for more than two seconds.

- **When the Wi-Fi Network is in idle mode:** The machine is immediately disconnected from the wireless network, and the wireless LED is off.
- **When the Wi-Fi Network is being used:** While the machine waits until the current job is finished, the light blinks fast on the wireless LED. Then, the wireless network connection is automatically disconnected. The wireless LED is off.

 When the Wi-Fi Network is disconnected, press the **WPS** () button on the control panel. The Wi-Fi network is on and the setting a wireless network begins.

USING A WIRELESS NETWORK FROM THE COMPUTER

Choosing your network connection

Typically, you can only have one connection between your computer and the machine at a time. There are types of network connections to consider.

- Wireless network without access point (Ad-Hoc mode)
- Wireless network with an access point (Infrastructure mode)

How to print a network configuration report

You can identify the network settings of your machine by printing a network configuration report.

To print the report:

1. In ready mode, press and hold  **Stop/Clear** button on the control panel for long enough (about four seconds) until the **Status LED** blinks fast.
2. Then, release the button.

Using this **Network Configuration Report**, you can find your machine MAC address and IP address.

For example:

- MAC Address:00:15:99:41:A2:78
- IP Address:192.0.0.192

IP addresses



Every device in a network has a unique numerical address called an **IP Address**. Your machine came with a Default IP address of 192.0.0.192, which you can verify by printing out a **Network Configuration Report** or **Configuration Report**.

- **DHCP IP assignment:** Connect your machine to the network, and wait a few minutes for the DHCP server to assign an IP address to the machine. Then, print the **Network Configuration Report** as explained above. If the report shows that the IP address has changed, the assignment was successful. You will see the new IP address in the report.
- **Static IP assignment:** Use the SetIP program to change the IP address from your computer (See "Setting IP address" on page 31).

In an office environment, we recommend that you contact a network administrator to set this address for you.

Wireless network name and network key

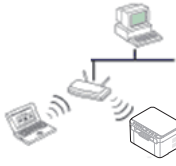
Wireless networks require higher security, so when an access point is first set up, a network name (SSID), the type of security used, and a Network Key are created for the network. Locate this information before proceeding with the machine installation.

	Infrastructure mode This is an environment generally used for homes and SOHOs. This mode uses an access point to communicate with the wireless machine. <ul style="list-style-type: none">• See "Installing the machine on a wireless network with an access point (Windows)" on page 38.• See "Installing the machine on a wireless network with an access point (Macintosh)" on page 40.
	Ad-Hoc mode This mode does not use an access point. The wireless computer and wireless machine communicates directly. <ul style="list-style-type: none">• See "Installing the machine on an Ad-Hoc wireless network (Windows)" on page 39.• See "Installing the machine on an Ad-Hoc wireless network (Macintosh)" on page 41.

 After choosing your configuration, follow the simple directions for your computer operating system, but first locate the software CD supplied with the machine before proceeding.

Installing a wireless network with cables

You can install a wireless network to connect to the machine with either a USB cable or a network cable. For most users, we recommend using a USB cable with the program provided in the supplied software CD.

The following are two ways to install a wireless network with cables.

- **With a USB cable:** You can simply set up a wireless network using the program in the supplied software CD. Only Windows and Macintosh operating system are supported (See "Setting a wireless network with USB cable" on page 38).

 You can also install a wireless network in Printer Settings Utility with USB cable after installing driver. (Windows and Macintosh operating system are supported.)

- **With a network cable:** You can set up a wireless network using the SyncThru™ Web Service program (See "Setting a wireless network with

network cable" on page 42).

SETTING A WIRELESS NETWORK WITH USB CABLE

 Refer to your network administrator, or the person that set up your wireless network, for information about your network configuration.

Installing the machine on a wireless network with an access point (Windows)

Items to prepare

Ensure you have next items ready.

- Access point
- Network-connected computer
- Software CD that provided with your machine
- The machine installed with a wireless interface
- USB cable

Creating the infrastructure network in Windows

When the items are ready, follow below steps:

1. Check whether the USB cable is connected to the machine.
2. Turn on your computer, access point and machine.
3. Insert the supplied software CD into your CD-ROM drive.
 - The software CD should automatically run and an installation window appears.
 - If the installation window does not appear, click **Start** and then **Run**. Type X:\Setup.exe, replacing "X" with the letter which represents your CD-ROM drive. Click **OK**.
 - If you use Windows Vista, Windows 7 or Windows Server 2008 R2 click **Start > All programs > Accessories > Run**. Type X:\Setup.exe replacing "X" with the letter which represents your CD-ROM and click **OK**.
 - If the **AutoPlay** window appears in Windows Vista, Windows 7 or Windows Server 2008 R2, click **Run Setup.exe** in **Install or run program** field, and click **Continue** or **Yes** in the **User Account Control** windows.
4. Select the **Wireless Setting and Installation** option.

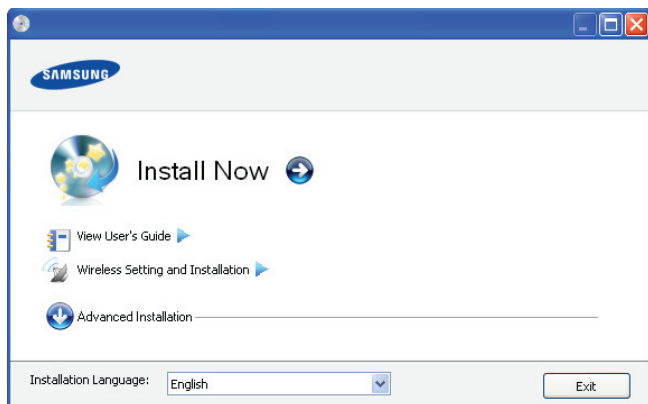

- **Install Now:** First you must configure the wireless network settings of your printer to print through wireless.
- **Wireless Setting and Installation:** Configure the wireless network settings of your printer with a USB cable then install the printer driver. Press this button to set up the wireless connection

if you have not set up the wireless connection before.

5. Read **License Agreement**, and select **I accept the terms of the License Agreement**. Then, click **Next**.
6. The software searches the wireless network.

 If the searching has failed, you may check if the USB cable is connected between the computer and machine properly, and follow the instruction on the window.

7. After searching, the window shows the wireless network devices. Select the name (SSID) of access point you are using and click **Next**.

 If you cannot find out the network name you want to choose, or if you want to set the wireless configuration manually, click **Advanced Setting**.

- **Enter the wireless Network Name:** Type the SSID of access point you want (SSID is case-sensitive).
- **Operation Mode:** Select **Infrastructure**.
- **Authentication:** Select an authentication type.
 - Open System:** Authentication is not used, and encryption may or may not be used, depending on the need for data security.
 - Shared Key:** Authentication is used. A device that has a proper WEP key can access the network.
 - WPA Personal or WPA2 Personal:** Select this option to authenticate the print server based on WPA Pre-Shared Key. This uses a shared secret key (generally called Pre Shared Key pass phrase) which is manually configured on the access point and each of its clients.
- **Encryption:** Select the encryption. (None, WEP64, WEP128, TKIP, AES, TKIP AES)
- **Network Key:** Enter the encryption network key value.
- **Confirm Network Key:** Confirm the encryption network key value.
- **WEP Key Index:** If you are using the WEP Encryption, select the appropriate **WEP Key Index**.

 The wireless network security window does appear when the access point has security setting.

The wireless network security window appears. The window may differ according to its security mode, WEP or WPA.

- **In case of WEP**

Select **Open System** or **Shared Key** for the authentication and enter WEP security key. Click **Next**.

WEP (Wired Equivalent Privacy) is a security protocol preventing unauthorized access to your wireless network. WEP encrypts the data portion of each packet exchanged on a wireless network using a 64-bit or 128-bit WEP encryption key.

- **In case of WPA**

Enter the WPA shared key and click **Next**.

WPA authorizes and identifies users based on a secret key that changes automatically at regular intervals. WPA also uses TKIP (Temporal Key Integrity Protocol) and AES (Advanced Encryption Standard) for data encryption.

8. The window shows the wireless network setting and check if settings are right. Click **Next**.

- **For the DHCP method**

If the IP address assignment method is DHCP, check if DHCP is shown in the window. However, if it shows Static, click **Change**

TCP/IP to change the assignment method to DHCP.

- **For the Static method**

If the IP address assignment method is Static, check if Static is shown in the window. However, if it shows DHCP, click **Change TCP/IP** to enter the IP address and other network configuration values for the machine. Before entering the IP address for the machine, you must know the computer's network configuration information. If the computer is set to DHCP, you must contact the network administrator to get the static IP address.

Example)

If computer's network information is as below:

- IP address: 169.254.133.42
- Subnet Mask: 255.255.0.0

Machine's network information should be as below:

- IP address: 169.254.133. 43 (Use computer's IP address, with changed last three digits.)
- Subnet Mask: 255.255.0.0 (Use the computer's subnet mask.)
- Gateway: 169.254.133.1 (Change the last three digits from IP address of your machine to 1.)

9. When the wireless network setting is completed, disconnect the USB cable between the computer and machine. Click **Next**.
10. **Wireless Network Setting Complete** window appears. Then, click **Next**.
Select **Yes** if you accept the current settings and continue the setup procedure.
Select **No** if you want to return to the beginning screen.
Then, click **Next**.
11. Click **Next** when the **Confirm Printer Connection** window appears.
12. Select the components to be installed. Click **Next**.
After selecting the components, you can also change the machine name, set the machine to be shared on the network, set the machine as the default machine, and change the port name of each machine. Click **Next**.
13. After the installation is finished, a window asking you to print a test page appears. If you want to print a test page, click **Print a test page**.
Otherwise, just click **Next** and skip to step 15.
14. If the test page prints out correctly, click **Yes**.
If not, click **No** to reprint it.
15. To register as a user of the machine in order to receive information from Samsung, click **On-line Registration**.
16. Click **Finish**.

Installing the machine on an Ad-Hoc wireless network (Windows)

If you do not have an access point (AP), you may still connect the machine wirelessly to your computer by setting up an Ad-Hoc wireless network by following the simple steps below.

Items to prepare

Ensure you have next items ready.

- Wireless network computer
- Software CD provided with your machine
- Wireless network machine
- USB cable

Creating the Ad-Hoc network in Windows

When the items are ready, follow below steps:

1. Check whether the USB cable is connected to the machine.
2. Turn on your computer and the wireless network machine.
3. Insert the supplied software CD into your CD-ROM drive.
 - The software CD should automatically run and an installation window appear.
 - If the installation window does not appear, click **Start** and then **Run**. Type X:\Setup.exe, replacing "X" with the letter which represents your drive. Click **OK**.
 - If you use Windows Vista, Windows 7 or Windows Server 2008 R2 click **Start** > **All programs** > **Accessories** > **Run**. Type X:\Setup.exe replacing "X" with the letter which represents your drive and click **OK**.
 - If the **AutoPlay** window appears in Windows Vista, Windows 7 or Windows Server 2008 R2, click **Run Setup.exe** in **Install or run program** field, and click **Continue** or **Yes** in the **User Account Control** windows.
4. Select the **Wireless Setting and Installation** option.

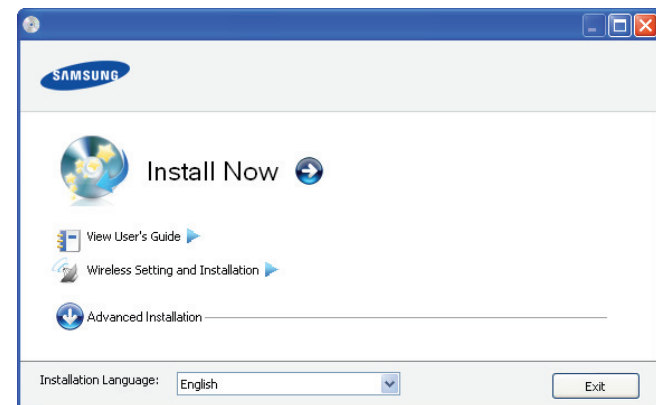

- **Install Now:** First you must configure the wireless network settings of your printer to print through wireless.
 - **Wireless Setting and Installation:** Configure the wireless network settings of your printer with a USB cable then install the printer driver. Press this button to set up the wireless connection if you have not set up the wireless connection before.
5. Read the **License Agreement**, and select **I accept the terms of the License Agreement**. Then, click **Next**.
 6. The software searches the wireless network.
 - ☞ If the software has failed to search the network, check if the USB cable is connected properly between the computer and machine, and follow the instruction on the window.
 7. After searching the wireless network, a list of wireless network your machine has searched appears.
If you want to use the Samsung default ad-hoc setting, select the last wireless network on the list, which **Network Name(SSID)** is **airportthru** and **Signal** is **Printer Self Network**.
Then, click **Next**.
If you want to use other ad-hoc settings, select other wireless network from the list.
 - ☞ If you want to change ad-hoc settings click the **Advanced Setting** button.
 - **Enter the wireless Network Name:** Type in the SSID

name you want (SSID is case-sensitive).

- **Operation Mode:** Select **Ad-hoc**.
- **Channel:** Select the channel.
- **Authentication:** Select an authentication type.
Open System: Authentication is not used, and encryption may or may not be used, depending on the need for data security.
Shared Key: Authentication is used. A device that has a proper WEP key can access the network.
- **Encryption:** Select the encryption. (None, WEP64, WEP128)
- **Network Key:** Enter the encryption network key value.
- **Confirm Network Key:** Confirm the encryption network key value.
- **WEP Key Index:** If you are using the WEP Encryption, select the appropriate **WEP Key Index**.



The wireless network security window appears when the ad-hoc network has security setting.

The wireless network security window appears. Select **Open System** or **Shared Key** for the authentication and click **Next**.

- WEP (Wired Equivalent Privacy) is a security protocol preventing unauthorized access to your wireless network. WEP encrypts the data portion of each packet exchanged on a wireless network using a 64-bit or 128-bit WEP encryption key.

8. The window which shows the wireless network setting appears. Check the settings and click **Next**.



Before entering the IP address for the machine, you must know the computer's network configuration information. If the computer's network configuration is set to DHCP, the wireless network setting should also be DHCP. Likewise, if the computer's network configuration is set to Static, the wireless network setting should also be Static.

If your computer is set to DHCP and you want to use Static wireless network setting, you must contact the network administrator to get the static IP address.

- **For the DHCP method**
If the IP address assignment method is DHCP, check if DHCP is shown in the **Wireless Network Setting Confirm** window. However, if it shows Static, click **Change TCP/IP** to change the assignment method to **Receive IP address automatically (DHCP)**.
- **For the Static method**
If the IP address assignment method is Static, check if Static is shown in the **Wireless Network Setting Confirm** window. However, if it shows DHCP, click **Change TCP/IP** to enter the IP address and other network configuration values for the machine.

Example)

If computer's network information is as below:

- IP address: 169.254.133.42
- Subnet Mask: 255.255.0.0

Machine's network information should be as below:

- IP address: 169.254.133. 43 (Use computer's IP address, with changed last three digits.)
- Subnet Mask: 255.255.0.0 (Use the computer's subnet mask.)

- Gateway: 169.254.133.1 (Change the last three digits from IP address of your machine to 1.)

9. When the wireless network setting is completed, disconnect the USB cable between the computer and machine. Click **Next**.



If the **Change PC Network Setting** window appears, follow the steps on the window.

Click **Next** if you are finished the computer's wireless network settings.

If you set the computer's wireless network as DHCP, it will take several minutes to receive the IP address.

10. The **Wireless Network Setting Complete** window appears. Select **Yes** if you accept the current settings and continue the setup procedure. Select **No** if you want to return to the beginning screen. Then, click **Next**.
11. Click **Next** when the **Confirm Printer Connection** window appears.
12. Select the components to be installed. Click **Next**.
After selecting the components, you can also change the machine name, set the machine to be shared on the network, set the machine as the default machine and change the port name of each machine. Click **Next**.
13. After the installation is finished, a window asking you to print a test page appears. If you want to print a test page, click **Print a test page**.
Otherwise, just click **Next** and skip to step 15.
14. If the test page prints out correctly, click **Yes**.
If not, click **No** to reprint it.
15. To register as a user of the machine in order to receive information from Samsung, click **On-line Registration**.
16. Click **Finish**.

Installing the machine on a wireless network with an access point (Macintosh)

Items to prepare

Ensure you have next items ready.

- Access point
- Network-connected computer
- Software CD that provided with your machine
- The machine installed with a wireless network interface
- USB cable

Creating the infrastructure network in Macintosh

When the items are ready, follow below steps:

1. Check whether the USB cable is connected to the machine.
2. Turn on your computer, access point and machine.
3. Insert the supplied software CD into your CD-ROM drive.
4. Double-click the CD-ROM icon that appears on your Macintosh desktop.
5. Double-click the **MAC_Installer** folder.
6. Double-click the **Installer OS X** icon.
7. Enter the password and click **OK**.
8. The Samsung Installer window opens. Click **Continue**.
9. Read the license agreement and click **Continue**.
10. Click **Agree** to agree to the license agreement.
11. Select **Easy Install** and click **Install**.

Easy Install is recommended for most users. All components necessary for machine operations will be installed. If you select **Custom Install**, you can choose individual operations will be installed.

12. Select the **Wireless Setting and Installation** option.

13. The software searches the wireless network.



If the searching has failed, you may check if the USB cable is connected between the computer and machine properly, and follow the instruction on the window.

14. After searching, the window shows the wireless network devices. Select the name (SSID) of access point you are using and click **Next**.



When you set the wireless configuration manually, click **Advanced Setting**.

- **Enter the wireless Network Name:** Type the SSID of access point you want (SSID is case-sensitive).
- **Operation Mode:** Select **Infrastructure**.
- **Authentication:** Select an authentication type.
Open System: Authentication is not used, and encryption may or may not be used, depending on the need for data security.
Shared Key: Authentication is used. A device that has a proper WEP key can access the network.
WPA Personal or WPA2 Personal: Select this option to authenticate the print server based on WPA Pre-Shared Key. This uses a shared secret key (generally called Pre Shared Key pass phrase) which is manually configured on the access point and each of its clients.
- **Encryption:** Select the encryption. (None, WEP64, WEP128, TKIP, AES, TKIP AES)
- **Network Key:** Enter the encryption network key value.
- **Confirm Network Key:** Confirm the encryption network key value.
- **WEP Key Index:** If you are using the WEP Encryption, select the appropriate **WEP Key Index**.



The wireless network security window does appear when the access point has security setting.

The wireless network security window appears. The window may differ according to its security mode, WEP or WPA.

• **In case of WEP**

Select **Open System** or **Shared Key** for the authentication and enter WEP security key. Click **Next**.

WEP (Wired Equivalent Privacy) is a security protocol preventing unauthorized access to your wireless network. WEP encrypts the data portion of each packet exchanged on a wireless network using a 64-bit or 128-bit WEP encryption key.

• **In case of WPA**

Enter the WPA shared key and click **Next**.

WPA authorizes and identifies users based on a secret key that changes automatically at regular intervals. WPA also uses TKIP (Temporal Key Integrity Protocol) and AES (Advanced Encryption Standard) for data encryption.

15. The window shows the wireless network setting and check if settings are right. Click **Next**.

- For the DHCP method
If the IP address assignment method is DHCP, check if DHCP is

shown in the window. However, if it shows Static, click **Change TCP/IP** to change the assignment method to DHCP.

- For the Static method
If the IP address assignment method is Static, check if Static is shown in the window. However, if it shows DHCP, click **Change TCP/IP** to enter the IP address and other network configuration values for the machine. Before entering the IP address for the machine, you must know the computer's network configuration information. If the computer is set to DHCP, you must contact the network administrator to get the static IP address.

Example)

If computer's network information is as below:

- IP address: 169.254.133.42
- Subnet Mask: 255.255.0.0

Machine's network information should be as below:

- IP address: 169.254.133.43 (Use computer's IP address, with changed last three digits.)
- Subnet Mask: 255.255.0.0 (Use the computer's subnet mask.)
- Gateway: 169.254.133.1 (Change the last three digits from IP address of your machine to 1.)

16. The wireless network is connecting according to the network configuration.

17. When the wireless network setting is completed, disconnect the USB cable between the computer and machine.

18. After the installation is finished, click **Restart**.

Installing the machine on an Ad-Hoc wireless network (Macintosh)

If you do not have a access point (AP), you may still connect the machine wirelessly to your computer by setting up an Ad-Hoc wireless network by following these simple directions.

Items to prepare

Ensure you have next items ready.

- Wireless network-connected computer
- Software CD that provided with your machine
- The machine installed with a wireless network interface
- USB cable

Creating the Ad-Hoc network in Macintosh

When the items are ready, follow below steps:

1. Check whether the USB cable is connected to the machine.
2. Turn on your computer and machine.
3. Insert the supplied software CD into your CD-ROM drive.
4. Double-click the CD-ROM icon that appears on your Macintosh desktop.
5. Double-click the **MAC_Installer** folder.
6. Double-click the **Installer OS X** icon.
7. Enter the password and click **OK**.
8. The Samsung Installer window opens. Click **Continue**.
9. Read the license agreement and click **Continue**.
10. Click **Agree** to agree to the license agreement.
11. Select **Easy Install** and click **Install**.

Easy Install is recommended for most users. All components necessary for machine operations will be installed. If you select **Custom Install**, you can choose individual operations will be

installed.

12. Click **Wireless Setting and Installation.**

13. The software searches the wireless network devices.

 If the searching has failed, you may check if the USB cable is connected between the computer and machine properly, and follow the instruction on the window.

14. After searching the wireless network, a list of wireless network your machine has searched appears.

If you want to use the Samsung default ad-hoc setting, select the last wireless network on the list, which **Network Name(SSID)** is **airportthru** and **Signal** is **Printer Self Network**.

Then, click **Next**.

If you want to use other ad-hoc settings, select other wireless network from the list.

 If you want to change ad-hoc settings click the **Advanced Setting** button.

- **Enter the wireless Network Name:** Type in the SSID name you want (SSID is case-sensitive).
- **Operation Mode:** Select **Ad-hoc**.
- **Channel:** Select the channel.
- **Authentication:** Select an authentication type.
Open System: Authentication is not used, and encryption may or may not be used, depending on the need for data security.
Shared Key: Authentication is used. A device that has a proper WEP key can access the network.
- **Encryption:** Select the encryption. (None, WEP64, WEP128)
- **Network Key:** Enter the encryption network key value.
- **Confirm Network Key:** Confirm the encryption network key value.
- **WEP Key Index:** If you are using the WEP Encryption, select the appropriate **WEP Key Index**.

 The wireless network security window appears when the ad-hoc network has security setting.

The wireless network security window appears. Select **Open System** or **Shared Key** for the authentication and click **Next**.

- WEP (Wired Equivalent Privacy) is a security protocol preventing unauthorized access to your wireless network. WEP encrypts the data portion of each packet exchanged on a wireless network using a 64-bit or 128-bit WEP encryption key.

15. The window which shows the wireless network setting appears. Check the settings and click **Next.**

 Before entering the IP address for the machine, you must know the computer's network configuration information. If the computer's network configuration is set to DHCP, the wireless network setting should also be DHCP. Likewise, if the computer's network configuration is set to Static, the wireless network setting should also be Static.

If your computer is set to DHCP and you want to use Static wireless network setting, you must contact the network administrator to get the static IP address.

- **For the DHCP method**
If the IP address assignment method is DHCP, check if DHCP is shown in the **Wireless Network Setting Confirm**

window. However, if it shows Static, click **Change TCP/IP** to change the assignment method to **Receive IP address automatically (DHCP)**.

- **For the Static method**

If the IP address assignment method is Static, check if Static is shown in the **Wireless Network Setting Confirm** window. However, if it shows DHCP, click **Change TCP/IP** to enter the IP address and other network configuration values for the machine.

Example)

If computer's network information is as below:

- IP address: 169.254.133.42
- Subnet Mask: 255.255.0.0

Machine's network information should be as below:

- IP address: 169.254.133.43 (Use computer's IP address, with changed last three digits.)
- Subnet Mask: 255.255.0.0 (Use the computer's subnet mask.)
- Gateway: 169.254.133.1 (Change the last three digits from IP address of your machine to 1.)

16. The wireless network is connecting according to the network configuration.

17. When the wireless network setting is completed, disconnect the USB cable between the computer and machine.

18. After the installation is finished, click **Restart.**

SETTING A WIRELESS NETWORK WITH NETWORK CABLE

Your machine is a network compatible machine. To enable your machine to work with your network you will need to perform some configuration procedures.

 Refer to your network administrator, or the person that set up your wireless network, for information about your network configuration.

Preparing items

Ensure you have next items ready.

- Access point
- Network-connected computer
- Software CD that provided with your machine
- The machine installed with a wireless network interface
- Network cable

Setting IP address

Firstly, you have to set up an IP address for network printing and managements. In most cases a new IP address will be automatically assigned by a DHCP (Dynamic Host Configuration Protocol) server located on the network.

In a few situations the IP address must be set manually. This is called a static IP and is often required in corporate Intranets for security reasons.

- **DHCP IP assignment:** Connect your machine to the network, and wait a few minutes for the DHCP server to assign an IP address to the machine. Then, print the **Network Configuration Report** as explained above. If the report shows that the IP address has changed, the assignment was successful. You will see the new IP address in the report (See "How to print a network configuration report" on page 37).
- **Static IP assignment:** Use SetIP program to change the IP address

from your computer.

In an office environment, we recommend that you contact a network administrator to set this address for you.

IP setting using SetIP Program (Windows)

This program is for manually setting the network IP address of your machine using its MAC address to communicate with the machine. A MAC address is the hardware serial number of the network interface and can be found in the **Network Configuration Report**.

For using SetIP program, disable the computer firewall before continuing by performing the following:

1. Open **Start > All programs > Control Panel**.
2. Double-click **Security Center**.
3. Click **Windows Firewall**.
4. Disable the firewall.

Installing the program

1. Insert the Printer Software CD-ROM provided with your machine. When the driver CD runs automatically, close that window.
2. Start Windows Explorer and open the X drive. (X represents your CD-ROM drive.)
3. Double-click **Application > SetIP**.
4. Double-click **Setup.exe** to install this program.
5. Click **OK**. If necessary, select a language from the drop-down list.
6. Follow the instructions in the window and complete the installation.

Starting the program

1. Connect your machine to the network with a network cable.
2. Turned on the machine.
3. From the Windows **Start** menu, select **All Programs > Samsung Printers > SetIP > SetIP**.
4. Click on the  icon (third from left) in the SetIP window to open the TCP/IP configuration window.
5. Enter the machine's new information into the configuration window as follows. In a corporate intranet, you may need to have this information assigned by a network manager before proceeding.

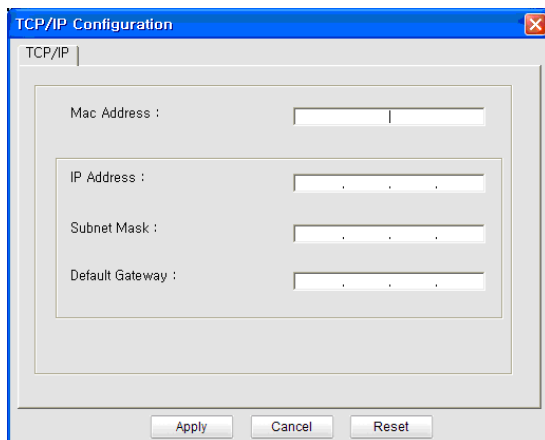

- **MAC Address:** Find the machine's MAC address from the **Network Configuration Report** and enter it without the colons. For example, 00:15:99:29:51:A8 becomes 0015992951A8.
- **IP Address:** Enter a new IP address for your printer. For example, if your computer's IP address is 192.168.1.150, enter 192.168.1.X. (X is number between 1 and 254 other than the computer's address.)

- **Subnet Mask:** Enter a Subnet Mask.
- **Default Gateway:** Enter a Default Gateway.

6. Click **Apply**, and then click **OK**. The machine will automatically print the **Network Configuration Report**. Confirm that all the settings are correct.
7. Click **Exit** to close the SetIP program.
8. If necessary, restart the computer's firewall.

IP setting using SetIP Program (Macintosh)

For using SetIP program, disable the computer firewall before continuing by performing the following:

 The path and UIs may differ by Mac OS version. Refer to the Mac OS manual.

1. Open **System Preferences**.
2. Click **Security**.
3. Click the **Firewall** menu.
4. Turn firewall off.

 The following instructions may vary for your model.

1. Connect your machine to the network with a network cable.
2. Insert the Installation CD-ROM, and open the disk window, select **MAC_Installer > MAC_Printer > SetIP > SetIPApplet.html**.
3. Double-click the file and **Safari** will automatically open, then select **Trust**. The browser will open the **SetIPApplet.html** page that shows the printer's name and IP address information.
4. Click on the  icon (third from left) in the SetIP window to open the TCP/IP configuration window.
5. Enter the machine's new information into the configuration window as follows. In a corporate intranet, you may need to have this information assigned by a network manager before proceeding.
 - **MAC Address:** Find the machine's MAC address from the **Network Configuration Report** and enter it without the colons. For example, 00:15:99:29:51:A8 becomes 0015992951A8.
 - **IP Address:** Enter a new IP address for your printer. For example, if your computer's IP address is 192.168.1.150, enter 192.168.1.X. (X is number between 1 and 254 other than the computer's address.)
 - **Subnet Mask:** Enter a Subnet Mask.
 - **Default Gateway:** Enter a Default Gateway.
6. Select **Apply**, then **OK**, and **OK** again. The printer will automatically print the configuration report. Confirm that all the settings are correct. **Quit Safari**. You may close and eject the installation CD-ROM. If necessary, restart the computer's firewall. You have successfully changed the IP address, subnet mask, and gateway.

Configuring the machine's wireless network

Before starting you will need to know the network name (SSID) of your wireless network and the network key if it is encrypted. This information was set when the access point (or wireless router) was installed. If you do not know about your wireless environment, please ask the person who has set up your network.

To configure wireless parameters, you can use **SyncThru™ Web Service**.

Using SyncThru™ Web Service

Before starting wireless parameter configuration, make sure cable connection status.

1. Check whether the network cable is connected to the machine. If not, connect the machine with a standard network cable.
2. Start a web browser such as Internet Explorer, Safari or Firefox and enter your machine's new IP address in the browser window.

For example,



3. Click **Login** on the upper right of the SyncThru™ Web Service website.
The **Login** window appears.
4. Type in the **ID** and **Password** then click **Login**.
If it's your first time logging into SyncThru™ Web Service, type in the below default ID and password.

- **ID: admin**
- **Password: sec00000**

5. When the **SyncThru™ Web Service** window opens, click **Network Settings**.
6. Click **Wireless > Wizard**.

 **Wizard** will help you setup the wireless network configuration. However, if you want to set the wireless network directly, select **Custom**.

7. Select the one **Network Name(SSID)** in the list.
 - **SSID:** SSID (Service Set Identifier) is a name that identifies a wireless network. access points and wireless devices attempting to connect to a specific wireless network must use the same SSID. The SSID is case-sensitive.
 - **Operation Mode:** **Operation Mode** refers to the type of wireless connections (See "Wireless network name and network key" on page 37).
 - **Ad-hoc:** Allows wireless devices to communicate directly with each other in a peer-to-peer environment.
 - **Infrastructure:** Allows wireless devices to communicate with each other through an access point.

 If your network's **Operation Mode** is **Infrastructure**, select the SSID of the access point. If the **Operation Mode** is **Ad-hoc**, select the machine's SSID. Note that "airportthru" is the default SSID of your machine.

8. Click **Next**.
If wireless security setting window appears, enter the registered password (network key) and click **Next**.
9. The confirmation window appears, please check your wireless setup. If the setup is right, click **Apply**.

 Disconnect the network cable (standard or network). Your machine should then start communicating wirelessly with the network. In case of Ad-hoc mode, you can use a wireless LAN and wired LAN simultaneously.

COMPLETING THE INSTALLATION

After you have installed your Samsung wireless network printer, print another copy of the Network Configuration Report and keep it for future reference. You are now ready to use your new Samsung wireless printer on your network.

TROUBLESHOOTING

Solve problems that might occur during wireless setting and installing the machine driver.

Wireless network problems

If problems occur while using the machine on a network, check the followings.

Printers Not Found

- Your machine may not be turned on. Turn on your computer and the machine.
- USB cable is not connected between your computer and machine. Connect machine to your computer using the USB cable.
- The machine does not support wireless network. Check the machine's user's guide included on the software CD supplied with your machine and prepare a wireless network machine.

Connecting Failure - Not found SSID

- The machine is unable to search network name (SSID) which you have selected or typed in. Check the network name (SSID) on your access point and try connecting again.
- Your access point is not turned on. Turn on your access point.

Connecting Failure - Invalid Security

- You configured security incorrectly. Check the configured security on your access point and machine.

Connecting Failure - General Connection Error

- Your computer is not receiving a signal from your machine. Check the USB cable and your machine power.
- When Temporal Key Integrity Protocol(TKIP) security is set up for the access point, connection might fail. Change the access point settings.

Connecting Failure - Connected Wired Network

- Your machine is connected with wired network cable. Remove the wired network cable from your machine.

PC Connection Error

- The configured network address is unable to connect between your computer and machine.
 - For DHCP network environment
The print receives the IP address automatically (DHCP) when computer is configured to DHCP.
 - For Static network environment
The machine uses the static address when computer is configured to static address.
If you computer has following addresses,
 - IP address: 192.168.1.100
 - Subnet address: 255.255.255.0
 - Gateway address: 192.168.1.1
 Type in the following address for your machine,
 - IP address: 192.168.1.101
 - Subnet address: 255.255.255.0
 - Gateway address: 192.168.1.1

Solving other problems

If problems occur while using the machine on a network, check the followings.

 For information on access point (or wireless router), refer to its own user's guide.

- Your computer, access point or machine may not be turned on.
- Check the wireless reception around the machine. If the reception is far from the machine or there is an obstacle, you might have difficulty receiving the signal.
- Cycle the power for access point (or wireless router), machine and computer. Sometimes cycling the power can recover network communication.
- Check whether firewall software (V3 or Norton) is blocking the communication.

If the computer and the machine is connected on a same network it cannot be searched, firewall software might be blocking the communication. Refer to the user's guide for the software to turn it off and try searching the machine again.

- Check whether the machine's IP address is allocated correctly. You can check the IP address by printing the network configuration report.
- Check whether access point (or wireless router) has a configured security (password). If it has a password, refer to the access point (or wireless router) administrator.
- Check whether the machine's IP address. Reinstall the machine driver and change the settings to connect to the machine on the network. Due to the characteristics of DHCP, the allocated IP address could change if the machine is not used for a long time or if the access point has been reset.
- Check the wireless environment. You might not be able to connect to the network in the infrastructure environment where you need to type in a user's information before connecting to access point (or wireless router).
- This machine only supports IEEE 802.11 b/g/n and Wi-Fi. For some counties, only 802.11 b/g can be applied. Other wireless communication (Bluetooth) is not supported.
- When using the Ad-hoc mode, for operating systems such as Windows Vista, you might need to set the wireless connection setting every time you use the wireless machine.
- You cannot use infrastructure mode and Ad-hoc mode at the same time for Samsung wireless network machine.
- The machine is within the range of the wireless network.
For most networks, the machine should be within 30 meters (100 feet) of the wireless access point (or wireless router).
- The machine is located away from obstacles that could block the wireless signal.
Remove any large metal objects between the access point (or wireless router) and the machine.
Make sure the machine and wireless access point (or wireless router) are not separated by poles, walls, or support columns containing metal or concrete.
- The machine is located away from other electronic devices that may interfere with the wireless signal.
Many devices can interfere with the wireless signal, including baby monitors, motors, cordless phones, security system cameras, other wireless networks, and some Bluetooth devices.

basic setup

After installation is complete, you may want to set the machine's default settings. Refer to the next section if you would like to set or change values. This chapter gives you step-by-step instructions for setting up the machine.

This chapter includes:

- Altitude adjustment
- Setting the default tray and paper

ALTITUDE ADJUSTMENT

The print quality is affected by atmospheric pressure, which is determined by the height of the machine above sea level. The following information will guide you on how to set your machine to the best print quality or best quality of print.

Before you set the altitude value, determine the altitude where you are.

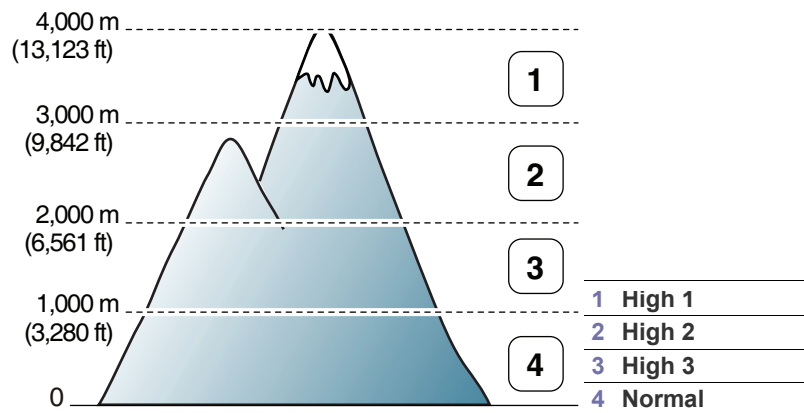

You can altitude adjustment in Printer Settings Utility.

1. Double-click the Smart Panel icon on the Windows task bar (or Notification Area in Linux). You can also click Smart Panel on the status bar in Mac OS X (See "Using the Smart Panel program" on page 70). Or, if you are a Windows user, you can launch it from the **Start** menu, select **Programs** or **All Programs** > **Samsung Printers** > **your printer driver name** > **Smart Panel**.
2. Click **Printer Setting**.
3. Click **Setting** > **Altitude Adjustment**. Select necessary options from the drop-down list.
4. Click the **Apply** button.
If your machine is connected to a network, SyncThru™ Web Service screen appears automatically. This can be also adjusted via SyncThru™ Web Service.

SETTING THE DEFAULT TRAY AND PAPER

You can select the tray and paper you would like to keep using for printing job.

- Using the power saving feature
- Changing font setting

From your computer

Windows

1. Click the Windows **Start** menu.
2. For Windows 2000, select **Settings** > **Printers**.
 - For Windows XP/Server 2003, select **Printer and Faxes**.
 - For Windows Server 2008/Vista, select **Control Panel** > **Hardware and Sound** > **Printers**.
 - For Windows 7, select **Control Panel** > **Hardware and Sound** > **Devices and Printers**.
 - For Windows Server 2008 R2, select **Control Panel** > **Hardware** > **Devices and Printers**.
3. Right-click on your machine.
4. For Windows XP/Server 2003/Server 2008/Vista, press **Printing Preferences**.

For Windows 7/Windows Server 2008 R2, from context menus, select the **Printing Preferences**.

 If **Printing Preferences** item has a ► mark, you can select other printer drivers connected with the selected printer.

5. Click **Paper** tab.
6. Select tray and its options, such as paper size and type.
7. Press **OK**.

 If you want to use special-sized paper such as a billing paper, select **Edit...** in the **Paper** tab in the **Printing Preferences** (See "Opening printing preferences" on page 55).

Macintosh

Macintosh does not support this function. Macintosh users need to change the default setting manually each time they want to print using other settings.

1. Open a Macintosh application and select the file you want to print.
2. Open the **File** menu and click **Print**.
3. Go to **Paper Feed** pane.
4. Set appropriate tray from which you want to print.
5. Go to **Paper** pane.
6. Set paper type to correspond to the paper loaded in the tray from which you want to print.
7. Click **Print** to print.

Linux

1. Open **Terminal Program**.
2. When the Terminal screen appears, type in the following:
`[root@localhost root]# lpr <FileName>`

3. Select **Printer** and click **Properties...**
4. Click on the **Advanced** tab.
5. Select the tray (source) and its options, such as paper size and type.
6. Press **OK**.

USING THE POWER SAVING FEATURE

When you will not be using the machine for a while, you can use this feature to save power.

You change power save in Printer Settings Utility.

1. Double-click the Smart Panel icon on the Windows task bar (or Notification Area in Linux). You can also click Smart Panel on the status bar in Mac OS X.

Or, if you are a Windows user, you can launch it from the **Start** menu, select **Programs** or **All Programs** > **Samsung Printers** > **your printer driver name** > **Smart Panel**.

2. Click **Printer Setting**.
3. Click **Setting** > **Power Save**. Select the appropriate value from the drop-down list, and then click **Apply**.

CHANGING FONT SETTING

Your machine has preset font setting depending on your region or country.

If you want to change the font or set the font for special condition, such as the DOS environment, you can change the font setting as follows:

1. Double-click the Smart Panel icon on the Windows task bar (or Notification Area in Linux). You can also click Smart Panel on the status bar in Mac OS X.

Or, if you are a Windows user, you can launch it from the **Start** menu, select **Programs** or **All Programs** > **Samsung Printers** > **your printer driver name** > **Smart Panel**.

2. Click **Printer Setting**.
3. Click **Emulation**.
4. Confirm if **PCL** is selected in **Emulation Setting**.
5. Click **Setting**.
6. Select your preferred font in the **Symbol** set list.
7. Click **Apply**.

 Following information shows the proper font list for corresponding languages.

- **Russian:** CP866, ISO 8859/5 Latin Cyrillic
- **Hebrew:** Hebrew 15Q, Hebrew-8, Hebrew-7 (Israel only)
- **Greek:** ISO 8859/7 Latin Greek, PC-8 Latin/Greek
- **Arabic & Farsi:** HP Arabic-8, Windows Arabic, Code Page 864, Farsi, ISO 8859/6 Latin Arabic
- **OCR:** OCR-A, OCR-B

media and tray

This chapter provides information on how to load print media into your machine.

This chapter includes:

- Loading originals
- Selecting print media
- Changing the tray size

LOADING ORIGINALS

You can use the scanner glass to load an original for copying or scanning.

On the scanner glass

Using the scanner glass, you can copy or scan originals. You can get the best scan quality, especially for colored or gray-scaled images.

1. Lift and open the scanner lid.

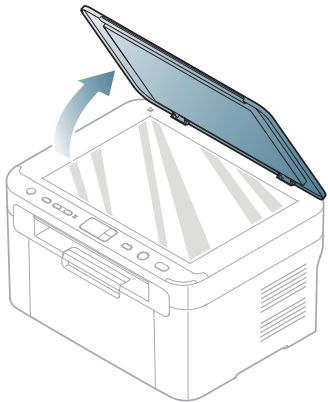

2. Place the original face down on the scanner glass. Align it with the registration guide at the top left corner of the glass.

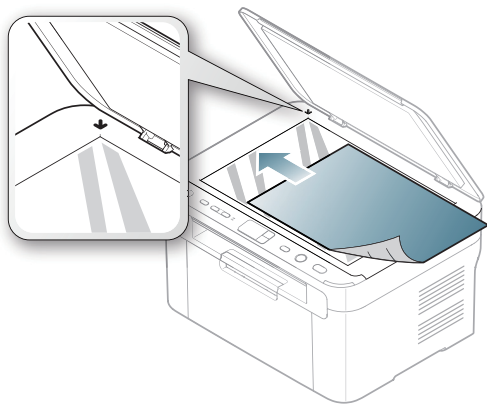

3. Close the scanner lid.



- Leaving the scanner lid open while copying may affect copy quality and toner consumption.
- Dust on the scanner glass may cause black spots on the printout. Always keep it clean (See "Cleaning the scan unit" on page 75).

- Loading paper in the tray
- Printing on special media
- Using the output support

- If you are copying a page from a book or magazine, lift the scanner lid until its hinges are caught by the stopper and then close the lid. If the book or magazine is thicker than 30 mm, start copying with the scanner lid open.



- Be careful not to break the scanner glass. You may get hurt.
- Do not put hands while closing the scanner lid. The scanner lid may fall on your hands and get hurt.
- Do not look the light from inside of the scanner while copying or scanning. It is harmful to eyes.

SELECTING PRINT MEDIA

You can print on a variety of print media, such as plain paper, envelopes, labels, and transparencies. Always use print media that meets the guidelines for use with your machine and from the appropriate tray.

Guidelines for selecting the print media

Print media that does not meet the guidelines outlined in this user's guide may cause the following problems:

- Poor print quality
- Increased paper jams
- Premature wear on the machine.
- Permanent fuser damage, not covered under warranty.

Properties, such as weight, composition, grain, and moisture content, are important factors that affect the machine's performance and the output quality. When you choose print materials, consider the following:

- The type, size and weight of the print media for your machine are described in print media specifications (See "Print media specifications" on page 93).
- Desired outcome: The print media you choose should be appropriate for your project.
- Brightness: Some print media are whiter than others and produce sharper, more vibrant images.
- Surface smoothness: The smoothness of the print media affects how crisp the printing looks on the paper.
- Some print media may meet all of the guidelines in this section and still not produce satisfactory results. This may be the result of the sheets characteristics, improper handling, unacceptable temperature and humidity levels, or other variables over which cannot be controlled.
- Before purchasing large quantities of print media, ensure that it meets the specifications in this user's guide and that it meets your output requirements.
- Using print media that does not meet these specifications may cause problems, requiring repairs. Such repairs are not covered by



the warranty or service agreements.

The amount of paper put into the tray may differ according to media type used (See "Print media specifications" on page 93).

- Using inflammable print media can cause a fire.
- Use designated print media (See "Print media specifications" on page 93).

! The use of inflammable media or foreign materials left in the printer may lead to overheating of the unit and, in rare cases may cause a fire.

Media sizes supported in each mode

MODE	SIZE	TYPE	SOURCE
Copy mode	Letter, A4, Legal, Oficio, US Folio, Executive, JIS B5, A5	For details about paper type, click the following link ("Print media specifications" on page 93).	Tray
Simplex printing	For details about paper size, click the following link ("Print media specifications" on page 93).	For details about paper type, click the following link ("Print media specifications" on page 93).	Tray
Duplex printing (Manual) ^a	Letter, A4, Legal, US Folio, Oficio	Plain, Color, Preprinted, Recycled, Bond, Archive	Manual feeding in the tray

a. 75 to 90 g/m² (20~24 lbs bond) only (See "Print media specifications" on page 93).

CHANGING THE TRAY SIZE

The tray is preset to Letter or A4 size, depending on your country. To change the size, you need to adjust the paper guides.

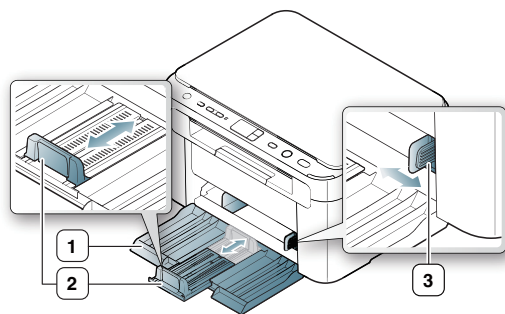

- 1 Tray
- 2 Paper length guide
- 3 Paper width guide

1. Open front door and pinch the paper length guide and pull it out to extend the tray.

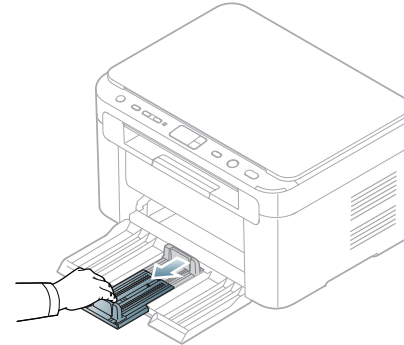
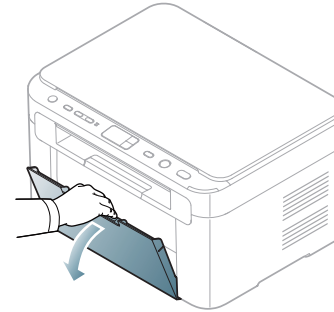

! Because the machine is very light, it can move when you open and close the tray or install and remove the toner cartridge. Be careful not to move the machine when performing these tasks.

2. Flex or fan the edge of the paper stack to separate the pages before loading the paper. Insert the paper into the tray.

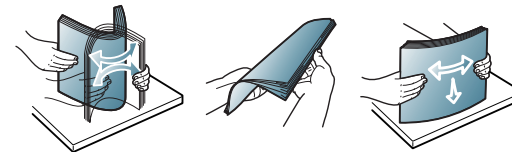

3. Load paper with the print side facing up. Make sure that all four corners are flat in the tray.

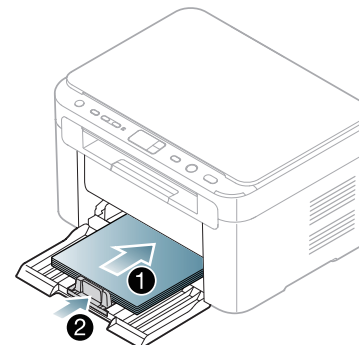

! Do not overload the tray. Ensure that the paper level is below the paper capacity mark on the inside of the tray.

- Pinch the paper length guide to adjust the guide so that it is flush up against the rear edge of the paper; then pinch the paper width guides so they are flush against the sides of the paper.

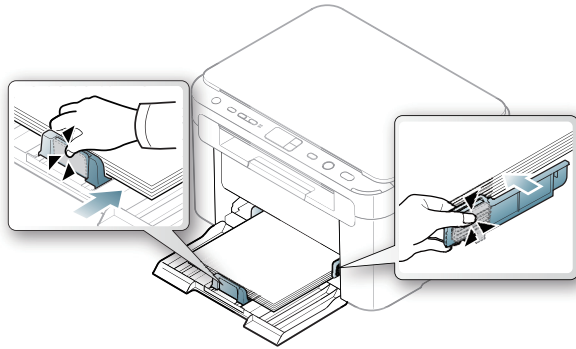

- Do not push the paper width guide too far causing the media to warp.
- Do not use a paper with more than 6 mm (0.24 inch.) curl.
- If you do not adjust the paper width guides, it may cause paper jams.

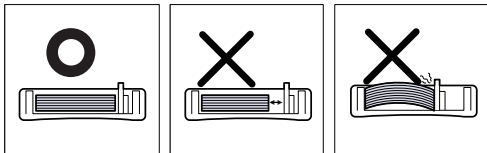

LOADING PAPER IN THE TRAY

Tray

- Open the front door, pinch the paper length guide and pull it out to extend the tray. Then, adjust the tray size to the media size you are loading (See "Changing the tray size" on page 49).
- Flex or fan the edge of the paper stack to separate the pages before loading papers.

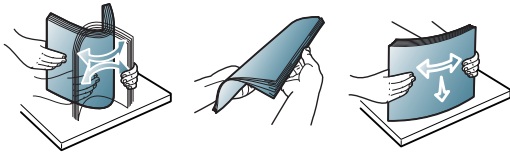

- Place the paper with the side you want to print facing up.

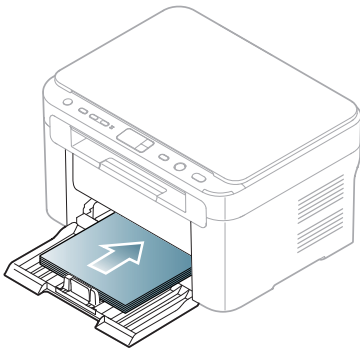

When you print a document, set the paper type and size for the tray. For information about setting the paper type and size on the control panel (See "Setting the default tray and paper" on page 46).

- If you experience problems with paper feeding, check whether the paper meets the media specifications. Then, try placing one sheet at a time in tray (See "Print media specifications" on page 93, and "Printing on special media" on page 51).
- The settings made from the machine driver override the settings on the control panel.

Manual feeding in the tray

The tray can hold special sizes and types of print material, such as postcards, note cards, and envelopes. It is useful for single page printing on letterhead or colored paper.

Tips on using the manual feeding method

- If you select **Paper > Source > Manual Feeder** from your printer driver, you need to press **Start** button each time you print a page. Load only one type, size and weight of print media at a time in the tray.
 - To prevent paper jams, do not add media while printing.
 - Print media should be loaded face up with the top edge going into the tray first and be placed in the center of the tray.
 - Always load the use recommended print media to avoid paper jams and print quality problems (See "Print media specifications" on page 93).
 - Flatten any curl on postcards, envelopes, and labels before loading them into the tray.
- Load the paper in the tray.

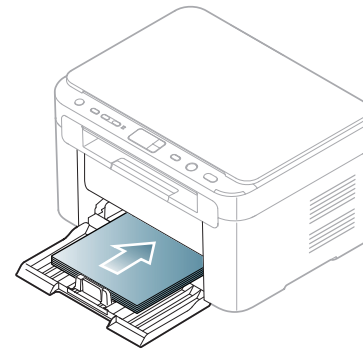

- When printing on special media, you must follow the loading guideline (See "Printing on special media" on page 51).
 - When paper does not feed well while printing, gently push the paper in manually until it starts feeding automatically.
- Squeeze the tray paper width guides and adjust them to the width of the paper. Do not force them too much, or the paper will bend resulting in a paper jam or skew.
 - Open the output tray and support.
 - To print from an application, open the application and open the print menu.
 - Open **Printing Preferences** (See "Opening printing preferences" on page 55).
 - Click on the **Paper** tab in **Printing Preferences**, and select an appropriate paper type.
 - For example, if you want to use a label, set the paper type to **Label**.
 - Select **Manual Feeder** in paper source, then press **OK**.
 - Start printing.

- ✍ If you are printing multiple pages, load the next sheet after the first page prints out, and press **Start** button. Repeat this step for every page to be printed.

PRINTING ON SPECIAL MEDIA

The table below shows the available special media for printing.

- ✍ When printing on a special media, we recommend you feed one paper at a time. Check the maximum input number of media for tray (See "Print media specifications" on page 93).

TYPES	TRAY	MANUAL FEEDING IN TRAY ^A
Plain	•	•
Thick	•	•
Thin	•	•
Cotton		•
Color		•
Preprinted		•
Recycled	•	•
Envelope		•
Transparency		•
Labels		•
CardStock		•
Bond		•
Archive	•	•

a. Load one paper at a time.

(●: supported, Blank: Not supported)

The following media types are shown in the **Printing Preferences**. This paper type option allows you to set the type of paper to be loaded in the tray. Selecting the appropriate media will let you get the best printout quality. Selecting inappropriate media can result in poor or unfused print quality; and/or cause jamming problems.

- **Plain:** Normal plain paper. Select this type if your printing on 60 to 120 g/m² (16 to 32 lbs bond).
- **Thick:** 90 to 163 g/m² (24 to 43 lbs bond) thick paper.
- **Thin:** 60 to 70 g/m² (16 to 19 lbs bond) thin paper.
- **Cotton:** 75 to 90 g/m² (20 to 24 lbs bond) cotton paper.
- **Color:** 75 to 90 g/m² (20 to 24 lbs bond) color-back grounded paper.
- **Preprinted:** 75 to 90 g/m² (20 to 24 lbs bond) preprinted/letterhead paper.
- **Recycled:** 60 to 90 g/m² (16 to 24 lbs bond) recycled paper.

- ✍ When you use recycled paper, printouts might be wrinkled and/or jamming may occur due to excessive curl.

- **CardStock:** 105 to 163 g/m² (28 to 43 lbs bond) cardstock.
- **Envelope:** 75 to 90 g/m² (20 to 24 lbs bond) envelope.
- **Transparency:** 138 to 146 g/m² (37 to 39 lbs bond) transparency paper.

- **Labels:** 120 to 150 g/m² (32 to 40 lbs bond) labels.
- **Bond:** 105 to 120 g/m² (28 to 32 lbs bond) bond.
- **Archive:** 70 to 90 g/m² (19 to 24 lbs bond) If you need to keep the print-out for a long time, such as for archives.

Envelopes

Successful printing on envelopes depends upon the quality of the envelopes.

To print on an envelope, the stamp area should be on the left side and the end of the envelope with the stamp area should enter the printer first in the center of the tray.

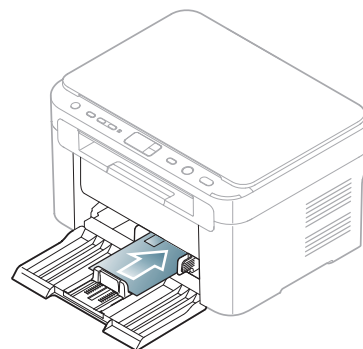

- When selecting envelopes, consider the following factors:
 - **Weight:** The weight of the envelope paper should not exceed 90 g/m² otherwise, jams may occur.
 - **Construction:** Prior to printing, envelopes should lie flat with less than 6 mm (0.24 inch.) of curl, and should not contain air.
 - **Condition:** Envelopes should not be wrinkled, nicked, either damaged.
 - **Temperature:** Use envelopes that are compatible with the heat and pressure of the machine during operation.
- Use only well-constructed envelopes with sharp-and well-creased folds.
- Do not use stamped envelopes.
- Do not use envelopes with clasps, snaps, windows, coated lining, self-adhesive seals, or other synthetic materials.
- Do not use damaged or poorly made envelopes.
- Be sure the seam at both ends of the envelope extends all the way to the corner of the envelope.

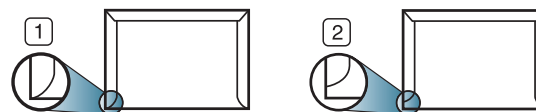

1 Acceptable

2 Unacceptable

- Envelopes with a peel-off adhesive strip or with more than one flap that folds over to seal must use adhesives compatible with the machine's fusing temperature about 170°C (338 °F) for 0.1 second. The extra flaps and strips might cause wrinkling, creasing, or jams, and may even damage the fuser.
- For the best print quality, position margins no closer than 15 mm (0.59 inch.) from the edges of the envelope.
- Avoid printing over the area where the envelope's seams meet.

Transparencies

To avoid damaging the machine, use only transparencies designed for laser printers.

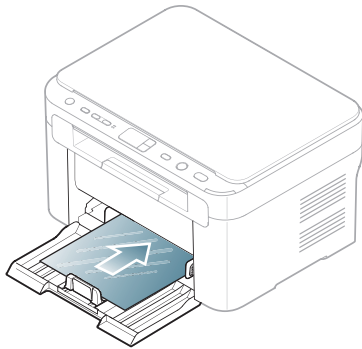

- Transparencies used in the machine must be able to withstand machine's fusing temperature.
- Place them on a flat surface after removing them from the machine.
- Do not leave unused transparencies on the paper tray for long periods of time. Dust and dirt may accumulate on them, resulting in spotty printing.
- To avoid smudging caused by fingerprints, handle transparencies carefully.
- To avoid fading, do not expose printed transparencies to prolonged sunlight.
- Ensure that transparencies are not wrinkled, curled, or have any torn edges.
- Do not use transparencies that separate from the backing sheet.
- To prevent transparencies from sticking to each other, do not let the printed sheets stack up as they are begin printed out.

Labels

To avoid damaging the machine, use only labels designed for laser machines.

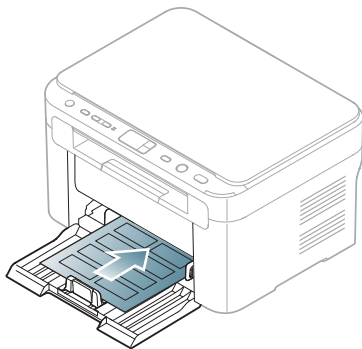

- When selecting labels, consider the following factors:
 - **Adhesives:** The adhesive material should be stable at your machine's fusing temperature (about 170°C (338 °F)).
 - **Arrangement:** Only use labels with no exposed backing between them. Labels can peel off sheets that have spaces between the labels, causing serious jams.
 - **Curl:** Prior to printing, labels must lie flat with no more than 13 mm (0.51 inch.) of curl in any direction.
 - **Condition:** Do not use labels with wrinkles, bubbles, or other indications of separation.
- Make sure that there is no exposed adhesive material between labels. Exposed areas can cause labels to peel off during printing, which can

cause paper jams. Exposed adhesive can also cause damage to machine components.

- Do not run a sheet of labels through the machine more than once. The adhesive backing is designed for only a single pass through the machine.
- Do not use labels that are separating from the backing sheet or are wrinkled, bubbled, or otherwise damaged.

Card stock/Custom-sized paper

Postcards, cards and other custom-sized materials can be printed with this machine.

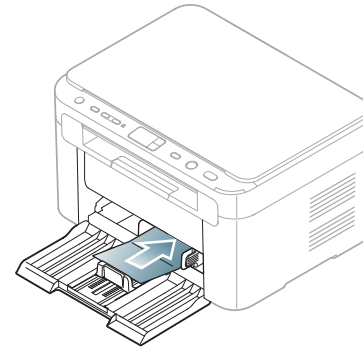

- Do not print on media smaller than 76 mm (3.00 inches) wide or 183 mm (7.20 inches) long.
- In software applications, set the margins at least 6.4 mm (0.25 inches) away from the edges of the material.

Letterhead/Preprinted paper

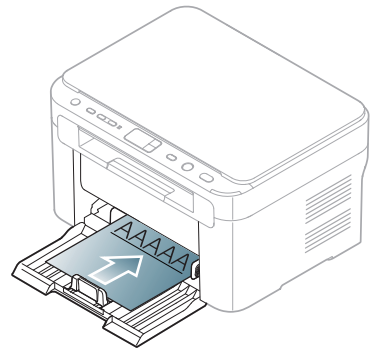
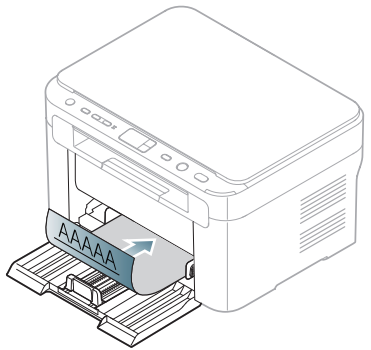
SINGLE-SIDED	DOUBLE-SIDED
<p data-bbox="1033 1033 1130 1062">Face up</p> 	<p data-bbox="1439 1033 1555 1062">Face down</p> 

- Letterhead/ Preprinted paper must be printed with heat-resistant ink that will not melt, vaporize, or release hazardous emissions when subjected to the machine's fusing temperature about 170°C(338 °F) for 0.1 second.
- Letterhead/ Preprinted paper ink must be non-flammable and should not adversely affect machine rollers.
- Forms and letterhead should be sealed in a moisture-proof wrapping to prevent changes during storage.
- Before you load letterhead/preprinted paper, verify that the ink on the paper is dry. During the fusing process, wet ink can come off preprinted paper, reducing print quality.

USING THE OUTPUT SUPPORT

 The surface of the output tray may become hot if you print a large number of pages at once. Make sure that you do not touch the surface, and do not allow children near it.

The printed pages stack on the output tray, and the output support will help the printed pages to align. The machine sends printouts to the output tray by default.

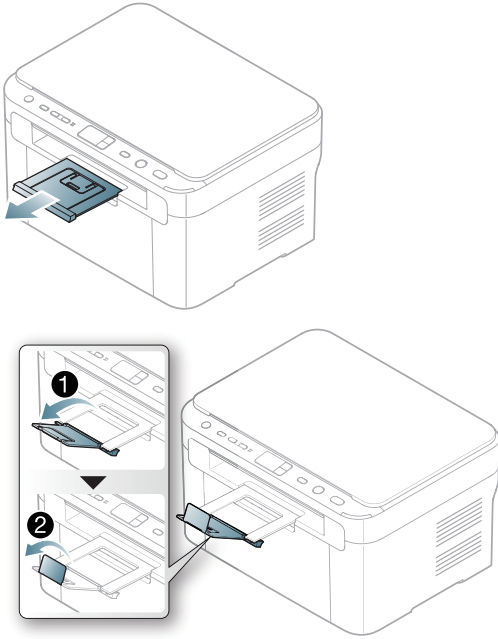

This chapter explains common printing tasks.

This chapter includes:

- Introducing useful software program
- Printer driver features
- Basic printing
- Opening printing preferences
- Using help
- Using special print features

 The procedures in this chapter are mainly based on Windows XP.

INTRODUCING USEFUL SOFTWARE PROGRAM

Samsung AnyWeb Print

This tool helps you to screen-capture, preview, scrap and print the screen of Windows Internet Explorer more easily, than when you use the ordinary program. Click **Start > All programs > Samsung Printers > Samsung AnyWeb Print > Download the latest version** to link the website where the tool is available for the download. This tool is available only for Windows operating systems.

PRINTER DRIVER FEATURES

Your printer drivers support the following standard features:

- Paper orientation, size, source, and media type selection
- Number of copies

In addition, you can use various special printing features. The following table shows a general overview of features supported by your printer driver:

 Some models or operating systems may not support some of the feature(s) in the following table.

Printer driver





FEATURE	WINDOWS
Print quality option	•
Poster printing	•
Multiple pages per sheet	•
Booklet printing (manual)	•
Fit to page printing	•
Reduce and enlarge printing	•
Different source for first page	•
Watermark	•
Overlay	•
Double-sided printing (manual)	•

(•: supported)

- Changing the default print settings
- Setting your machine as a default machine
- Printing to a file (PRN)
- Macintosh printing
- Linux printing

BASIC PRINTING

Your machine allows you to print from various Windows, Macintosh, or Linux applications. The exact steps for printing a document may vary depending on the application you use.

-  Your **Printing Preferences** window that appears in this user's guide may differ depending on the machine in use. However, the composition of the **Printing Preferences** window is similar. Check the operating system(s) that are compatible with your machine. Refer to the OS compatibility section of Printer Specifications (See "System requirements" on page 25).
- When you select an option in **Printing Preferences**, you may see a warning mark, , or . An exclamation mark () means you can select that certain option but it is not recommended, and () mark means you cannot select that option due to the machine's settings or environment.

The following procedure describes the general steps required for printing from various Windows applications.

-  Macintosh basic printing (See "Macintosh printing" on page 59).
- Linux basic printing (See "Linux printing" on page 60).

The following **Printing Preferences** window is for Notepad in Windows XP. Your **Printing Preferences** window may differ, depending on your operating system or the application you are using.

1. Open the document you want to print.
2. Select **Print** from the **File** menu. The **Print** window appears.
3. Select your machine from the **Select Printer** list.

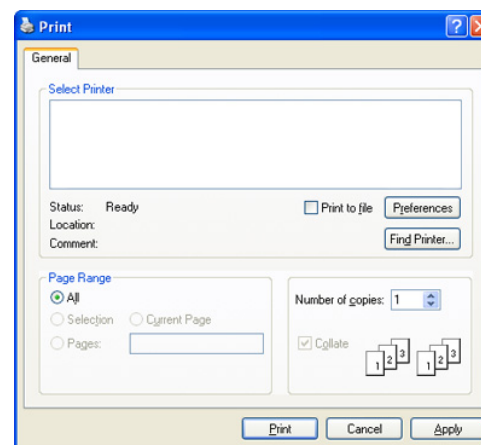

You can select the basic print settings, including the number of copies and the print range from within the **Print** window.

 To take advantage of the printer features provided by your printer driver, click **Properties** or **Preferences** in the application's **Print** window to change the print setting (See "Opening printing preferences" on page 55).

4. To start the print job, click **OK** or **Print** in the **Print** window.

 If you are using Windows Internet Explorer, the **Samsung AnyWeb Print** tool will save your time for screen-captured images or printing the image. Click **Start > All programs > Samsung Printers > Samsung AnyWeb Print** to link the website where the tool is available for the download.



Canceling a print job

If the print job is waiting in a print queue or print spooler, cancel the job as follows:

1. Click the Windows **Start** menu.
2. For Windows 2000, select **Settings > Printers**.
 - For Windows XP/Server 2003, select **Printer and Faxes**.
 - For Windows Server 2008/Vista, select **Control Panel > Hardware and Sound > Printers**.
 - For Windows 7, select **Control Panel > Hardware and Sound > Devices and Printers**.
 - For Windows Server 2008 R2, select **Control Panel > Hardware > Devices and Printers**.
3. For Windows Server 2000/XP/Server 2003/Server 2008/Vista, double-click your machine.
For Windows 7/Server 2008 R2, right-click your printer icon > context menus > **See what's printing**.

 If **See what's printing** item has a ► mark, you can select other printer drivers connected with selected printer.

4. From the **Document** menu, select **Cancel**.

 You can also access this window by simply double-clicking the machine icon () in the Windows task bar.

You can also cancel the current job by pressing  **Stop/Clear** button on the control panel.

OPENING PRINTING PREFERENCES

You can preview the settings you selected on the upper right of the **Printing Preferences**.

1. Open the document you want to print.
2. Select **Print** from the file menu. The **Print** window appears.
3. Select your machine from the **Select Printer**.

4. Click **Properties** or **Preferences**.

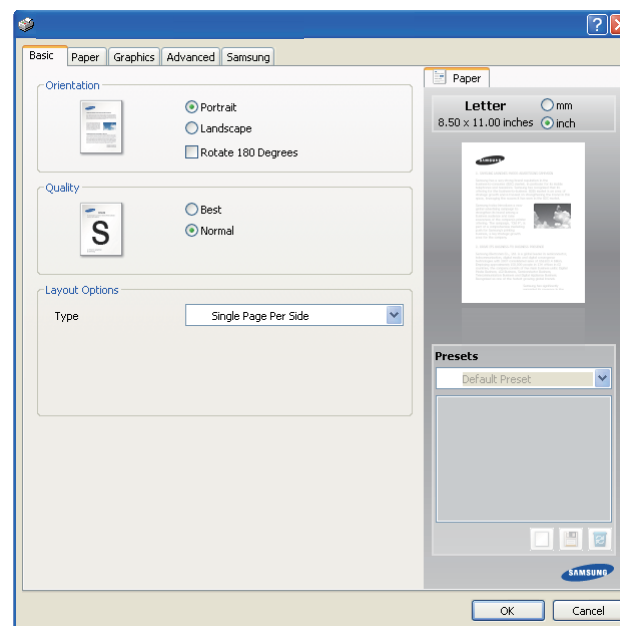

Using Presets setting

The **Presets** option, which is visible on each of the preferences tab except for the **Samsung** tab, allows you to save the current preferences for future use.

To save a **Presets** item:

1. Change the settings as needed on each tab.
2. Enter a name for the item in the **Presets** input box.

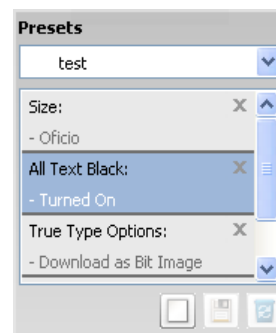

3. Click  (**Add**). When you save **Presets**, all current driver settings are saved.

Select more options and click  (**Update**), settings will be added to the **Presets** you made.

To use a saved setting, select it from the **Presets** drop-down list. The machine is now set to print according to the settings you have selected.

To delete saved settings, select it from the **Presets** drop-down list and click  (**Delete**).

You can also restore the printer driver's default settings by selecting **Default Preset** from the **Presets** drop-down list.

USING HELP

Click the question mark on the upper-right corner of the window and click on the topic you want to know about. Then a pop up window appears with information about that option's feature which is provided from the driver.



If you want to search information via a keyword, click the **Samsung** tab in the **Printing Preferences** window, and enter a keyword in the input line of the **Help** option. To get information about supplies, driver updates or registration and so on, click appropriate buttons.

USING SPECIAL PRINT FEATURES

Special print features include:

- "Printing multiple pages on one sheet of paper" on page 56.
- "Printing posters" on page 56.
- "Printing booklets (Manual)" on page 56.
- "Change percentage of your document" on page 57.
- "Fitting your document to a selected paper size" on page 57.
- "Using watermarks" on page 57.
- "Using overlays" on page 58.
- "Print quality options" on page 58.

Printing multiple pages on one sheet of paper

You can select the number of pages to print on a single sheet of paper. To print more than one page per sheet, the pages will be reduced in size and arranged in the order you specify. You can print up to 16 pages on one sheet.

1. To change the print settings from your software application, access **Printing Preferences** (See "Opening printing preferences" on page 55).
2. Click the **Basic** tab, select **Multiple Pages Per Side** in the **Type** drop-down list.
3. Select the number of pages you want to print per sheet (2, 4, 6, 9, or 16) in the **Pages per Side** drop-down list.
4. Select the page order from the **Page Order** drop-down list, if necessary.
5. Check **Print Page Border** to print a border around each page on the sheet.
6. Click the **Paper** tab, select the **Size**, **Source**, and **Type**.
7. Click **OK** or **Print** until you exit the **Print** window.

Printing posters

This feature allows you to print a single-page document onto 4, 9, or 16 sheets of paper, for the purpose of pasting the sheets together to form one poster-size document.

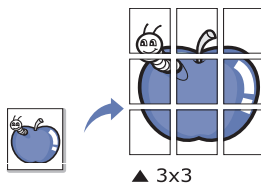

1. To change the print settings from your software application, access **Printing Preferences** (See "Opening printing preferences" on page 55).
2. Click the **Basic** tab, select **Poster Printing** in the **Type** drop-down list.
3. Select the page layout you want.

Available layouts:

- **Poster 2x2**: Document will be enlarged and be divided into 4 pages.
 - **Poster 3x3**: Document will be enlarged and be divided into 9 pages.
 - **Poster 4x4**: Document will be enlarged and be divided into 16 pages.
4. Select the **Poster Overlap** value. Specify **Poster Overlap** in millimeters or inches by selecting the radio button on the upper right of **Basic** tab to make it easier to paste the sheets together.

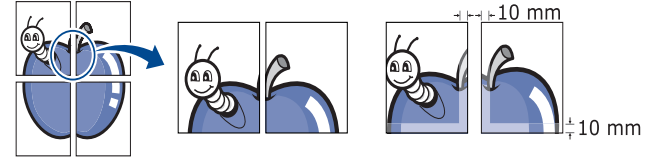

5. Click the **Paper** tab, select the **Size**, **Source**, and **Type**.
6. Click **OK** or **Print** until you exit the **Print** window.
7. You can complete the poster by pasting the sheets together.



Printing booklets (Manual)

This feature prints your document on both sides of a paper and arranges the pages so that the paper can be folded in half after printing to produce a booklet.

-  If you want to make a booklet, you need to print on Letter, Legal, A4, US Folio, or Oficio sized print media.



1. To change the print settings from your software application, access the **Printing Preferences** (See "Opening printing preferences" on page 55).
2. Click the **Basic** tab, select **Booklet Printing** from the **Type** drop-down list.
3. Click the **Paper** tab, select the **Size**, **Source**, and **Type**.

 The **Booklet Printing** option is not available for all paper sizes. In order to find out the available paper size for this feature, select the available paper size in the **Size** option on the **Paper** tab. If you select an unavailable paper size, this option can be automatically canceled. Select only available paper. (paper without  or  mark).
4. Click **OK** or **Print** until you exit the **Print** window.
5. After printing, fold and staple the pages.

Printing on both sides of the paper (Manual)

You can print on both sides of a paper (duplex). Before printing, decide how you want your document oriented. You can use this feature with Letter, Legal, A4, US Folio, or Oficio sized paper (See "Print media specifications" on page 93).

-  We recommend not to print on both sides of special media, such as labels, envelopes, or thick paper. It may cause a paper jam or damage the machine.

1. To change the print settings from your software application, access **Printing Preferences** (See "Opening printing preferences" on page 55).
2. Click the **Advanced** tab.

- From the **Double-Sided Printing (Manual)** section, select the binding option you want.

- **None**
- **Long Edge:** This option is the conventional layout used in bookbinding.

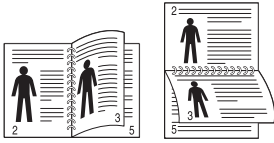

- **Short Edge:** This option is the conventional layout used in calendars.

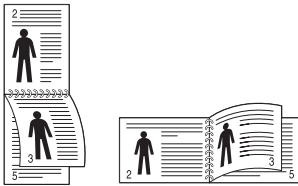

- Click the **Paper** tab, select the **Size**, **Source**, and **Type**.
- Click **OK** or **Print** until you exit the **Print** window.

-  If your machine does not have a duplex unit, you should complete the printing job manually. The machine prints every other page of the document first. After that, a message appears on your computer. Follow the on-screen instructions to complete the printing job.

Change percentage of your document

You can change the size of a document to appear larger or smaller on the printed page by typing in a percentage you want.

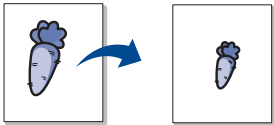

- To change the print settings from your software application, access **Printing Preferences** (See "Opening printing preferences" on page 55).
- Click the **Paper** tab.
- Enter the scaling rate in the **Percentage** input box.
You can also click the up/down arrows to select the scaling rate.
- Select the **Size**, **Source**, and **Type** in **Paper Options**.
- Click **OK** or **Print** until you exit the **Print** window.

Fitting your document to a selected paper size

This feature allows you to scale your print job to any selected paper size regardless of the document size. This can be useful when you want to check fine details on a small document.

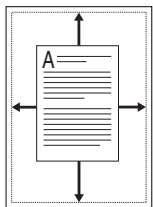

- To change the print settings from your software application, access **Printing Preferences** (See "Opening printing preferences" on page 55).
- Click the **Paper** tab.

- Select the paper size you want from the **Fit to Page**.
- Select the **Size**, **Source**, and **Type** in **Paper Options**.
- Click **OK** or **Print** until you exit the **Print** window.

Using watermarks

The watermark option allows you to print text over an existing document. For example, you use it when you want to have large gray letters reading "DRAFT" or "CONFIDENTIAL" printed diagonally across the first page or all pages of a document.

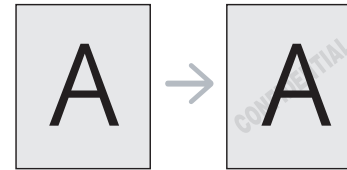

There are several predefined watermarks that come with the machine. They can be modified, or you can add new ones to the list.

Using an existing watermark

- To change the print settings from your software application, access **Printing Preferences** (See "Opening printing preferences" on page 55).
- Click the **Advanced** tab, and select the desired watermark from the **Watermark** drop-down list. You will see the selected watermark in the preview image.
- Click **OK** or **Print** until you exit the print window.

Creating a watermark

- To change the print settings from your software application, access **Printing Preferences** (See "Opening printing preferences" on page 55).
- From the **Advanced** tab, select **Edit** from the **Watermark** drop-down list. The **Edit Watermarks** window appears.
- Enter a text message in the **Watermark Message** box. You can enter up to 256 characters. The message displays in the preview window.
When the **First Page Only** box is checked, the watermark prints on the first page only.
- Select watermark options.
You can select the font name, style, size, and shade from the **Font Attributes** section, as well as set the angle of the watermark from the **Message Angle** section.
- Click **Add** to add a new watermark to the **Current Watermarks** list.
- When you have finished, click **OK** or **Print** until you exit the **Print** window.

To stop printing the watermark, select **None** from the **Watermark** drop-down list.

Editing a watermark

- To change the print settings from your software application, access **Printing Preferences** (See "Opening printing preferences" on page 55).
- Click the **Advanced** tab, select **Edit** from the **Watermark** drop-down list. The **Edit Watermarks** window appears.
- Select the watermark you want to edit from the **Current Watermarks** list and change the watermark message and options.
- Click **Update** to save the changes.
- Click **OK** or **Print** until you exit the **Print** window.

Deleting a watermark

1. To change the print settings from your software application, access **Printing Preferences** (See "Opening printing preferences" on page 55).
2. Click the **Advanced** tab, select **Edit** from the **Watermark** drop-down list. The **Edit Watermarks** window appears.
3. Select the watermark you want to delete from the **Current Watermarks** list and click **Delete**.
4. Click **OK** or **Print** until you exit the **Print** window.

Using overlays

An overlay is content you store on your hard disk drive that can be superimposed over any document you print. An overlay is often used to take the place of letterhead paper. Rather than using preprinted letterhead, you can create an overlay containing exactly the same information that is currently on your letterhead. To print a letter with your company's letterhead, you do not need to load preprinted letterhead paper in the machine, instead you can just print the letterhead overlay on your document.

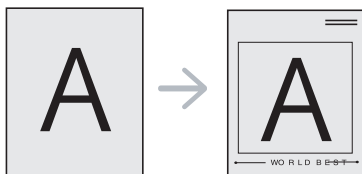

Creating a new overlay

To use a page overlay, you must create a new page overlay file containing your content.

1. Create or open a document containing the content you want to use in a new page overlay. Position the items exactly where you want them to appear when they are added to the original.
2. To save the document as an overlay, access **Printing Preference**. (See "Opening printing preferences" on page 55).
3. Click the **Advanced** tab, and select **Edit** from the **Text** drop-down list. The **Edit Overlay** window appears.
4. In the **Edit Overlay** window, click **Create**.
5. In the **Save As** window, type a name of up to eight characters in the **File name** box. Select the destination path, if necessary. (The default is C:\Formover.)
6. Click **Save**. The name appears on the **Overlay List**.
7. Click **OK** or **Print** until you exit the **Print** window.
8. The file is not printed. Instead, it is stored on your computer hard disk drive.

 The overlay document size must match same as the document you print. Do not create an overlay with a watermark.

Using an overlay

After an overlay has been created, it is ready to be printed with your document. To print an overlay on your document:

1. Create or open the document you want to print.
2. To change the print settings from your software application, access **Printing Preferences** (See "Opening printing preferences" on page 55).
3. Click the **Advanced** tab.
4. Select the desired overlay from the **Text** drop-down list.

5. If the overlay file you want does not appear in the **Text** drop-down list, select **Edit** from the list and click **Load**. Select the overlay file you want to use.

If you have stored the overlay file you want to use in an external source, you can also load the file when you access the **Open** window.

After you select the file, click **Open**. The file appears in the **Overlay List** box and is available for printing. Select the overlay from the **Overlay List** box.

6. If necessary, check **Confirm Page Overlay When Printing** box. If this box is checked, a message window appears each time you submit a document for printing, asking you to confirm that you wish to print an overlay over your document.

If this box is not checked and an overlay has been selected, the overlay automatically prints with your document.

7. Click **OK** or **Print** until you exit the **Print** window.

The selected overlay prints over your document.

 The resolution of the overlay document must match the resolution of the original print job.

Deleting an overlay

You can delete page overlays that you no longer use.

1. In the **Printing Preferences** window, click the **Advanced** tab.
2. Select **Edit** in the **Overlay** drop down list.
3. Select the overlay you want to delete from the **Overlay List** box.
4. Click **Delete**.
5. When the confirmation message window appears, click **Yes**.
6. Click **OK** or **Print** until you exit the **Print** window.

Print quality options

Use the following Graphics options to adjust the print quality for your specific printing needs.

1. To change the print settings from your software application, access **Printing Preferences** (See "Opening printing preferences" on page 55).
2. Click the **Graphics** tab.

 The options you can select may vary depending on your printer model.

- Refer to the help for each option's information provided from the **Printing Preferences**.

- **Font/Text:** Select **Clear Text** to print text sharper than on a normal document. Use **All Text Black** to print solid black, regardless of the color it appears on the screen.
- **Graphic Controller:** Fine Edge allows you to emphasize edges of texts and fine lines for improving readability.
- **Advanced:** Click this button, you can select **Darkness** and **Toner Save** features.

- **Darkness:** The option adjusts the toner density on print output. The values are **Normal**, **Light** and **Dark**.

- **Toner Save:** Selecting this option extends the life of your toner cartridge and reduces your cost per page without a significant reduction in print quality.

On: Select this option to allow the machine to use less toner on each page.

Off: Select this option if you do not want to save toner when printing a document.

3. Click **OK** or **Print** until you exit the **Print** window.

CHANGING THE DEFAULT PRINT SETTINGS

Most Windows applications will override settings you specify in the printer driver. Change all print settings available in the software application first, and change any remaining settings using the printer driver.

1. Click the Windows **Start** menu.
2. For Windows 2000, select **Settings > Printers**.
 - For Windows XP/Server 2003, select **Printers and Faxes**.
 - For Windows Server 2008/Vista, select **Control Panel > Hardware and Sound > Printers**.
 - For Windows 7, select **Control Panel > Hardware and Sound > Devices and Printers**.
 - For Windows Server 2008 R2, select **Control Panel > Hardware > Devices and Printers**.

3. Right-click your machine.

4. For Windows XP/Server 2003/Server 2008/Vista, press **Printing Preferences**.

For Windows 7 and Windows Server 2008 R2, from context menus, select the **Printing preferences**.

If **Printing preferences** item has a ► mark, you can select other printer drivers connected with the selected printer.

5. Change the settings on each tab.

6. Click **OK**.

If you want to change the settings for each print job, change it in **Printing Preferences**.

SETTING YOUR MACHINE AS A DEFAULT MACHINE

1. Click the Windows **Start** menu.
2. For Windows 2000, select **Settings > Printers**.
 - For Windows XP/Server 2003, select **Printers and Faxes**.
 - For Windows Server 2008/Vista, select **Control Panel > Hardware and Sound > Printers**.
 - For Windows 7, select **Control Panel > Hardware and Sound > Devices and Printers**.
 - For Windows Server 2008 R2, select **Control Panel > Hardware > Devices and Printers**.

3. Select your machine.

4. Right-click your machine and select **Set as Default Printer**.

If **Set as default printer** item has a ► mark, you can select other printer drivers connected with the selected printer.

PRINTING TO A FILE (PRN)

You will sometimes need to save the print data as a file. You can print the document to a file instead of routing it directly to a printer. The document is saved with the printer formatting, such as font selection and color specifications, in a .prn file that can be printed on another printer.

To save a print job as a file

1. Check the **Print to file** box at the **Print** window.

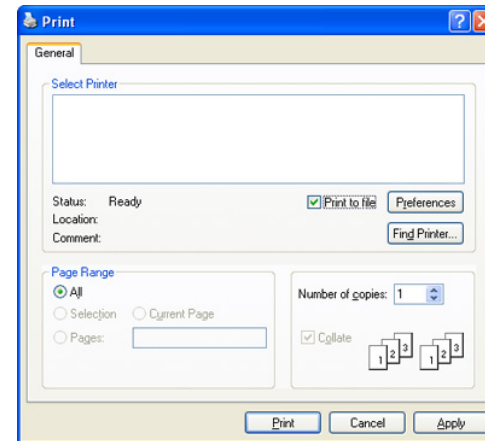

2. Click **Print**.

3. Type in the destination path and the file name, and then click **OK**. For example C:\Temp\file name.

If you type in only the file name, the file is automatically saved in **Documents and Settings** or **Users**. The saved folder may differ, depending on your operating system or the application you are using.

MACINTOSH PRINTING

This chapter explains how to print using a Macintosh. You need to set the print environment before printing.

- USB connected (See "Macintosh" on page 27).

Printing a document

When you print with a Macintosh, you need to check the printer driver setting in each application you use. Follow the steps below to print from a Macintosh:

1. Open an application and select the file you want to print.
2. Open the **File** menu and click **Page Setup (Document Setup** in some applications).
3. Choose your paper size, orientation, scaling, other options, and make sure that your machine is selected. Click **OK**.

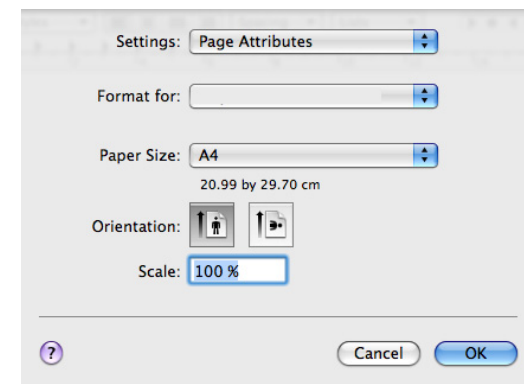

4. Open the **File** menu and click **Print**.

5. Choose the number of copies you want and indicate which pages you want to print.

6. Click **Print**.

Changing printer settings

You can use advanced printing features provided by your machine.

Open an application and select **Print** from the **File** menu. The machine name, which appears in the printer properties window may differ depending on the machine in use. Except for the name, the composition of the printer properties pane is similar to the following.

- The setting options may differ depending on models and Macintosh OS versions.
- The following panes may differ, depending on your operating system or the application you are using.

The following pane is the first pane you will see when you open the printer properties pane. Select other advanced features from the drop down list.

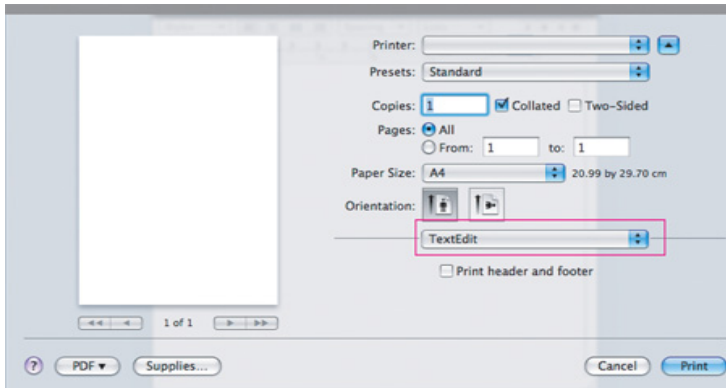

Layout

The **Layout** dialog provides options to adjust how the document appears on the printed page. You can print multiple pages on one sheet of paper. Select **Layout** from the drop-down list under **Orientation** to access the following features.

- **Pages per Sheet:** This option determines how many pages to be printed on one page (See "Printing multiple pages on one sheet of paper" on page 60).
- **Layout Direction:** This option allows you to select the printing direction on a page similar to the examples on UI.
- **Border:** This option allows you to print a border around each page on the sheet.
- **Reverse Page Orientation:** This option allows you to rotate paper 180 degrees.

Graphics

The **Graphics** dialog provides options for selecting **Resolution**. Select **Graphics** from the drop-down list under **Orientation** to access the graphic features.

- **Resolution (Quality):** This option allows you to select the printing resolution. The higher the setting, the sharper the clarity of printed characters and graphics. A higher setting will also increase the time it takes to print a document.
- **Darkness:** This option allows you to enhance the darkness of the printouts. The available options are **Normal**, **Light**, and **Dark**.

Paper

Set **Paper Type** to correspond to the paper loaded in the tray from which you want to print. This will let you get the best quality printout. If you load a different type of print material, select the corresponding paper type.

Printer Settings

The **Printer Settings** dialog provides **Toner Save Mode**, **Reprint When Jammed**, and **Power Save** options. Select **Printer Settings** from the drop-down list under **Orientation** to access the following features:

- **Toner Save Mode:** Selecting this option extends the life of your toner cartridge and reduces your cost per page without a significant reduction in print quality.
 - **Printer Setting:** If you select this option, this feature is determined by the setting you've made from the machine (For some models, you cannot change the setting from the machine. In this case, the default setting is Off).
 - **On:** Select this option to allow the printer to use less toner on each page.
 - **Off:** Set this option if you do not need to save toner when printing a document.
- **Power Save:** When this option is checked, the switches to the power save mode after a predetermined amount of time.

Printing multiple pages on one sheet of paper

You can print more than one page on a single sheet of paper. This feature provides a cost-effective way to print draft pages.

1. Open an application, and select **Print** from the **File** menu.
2. Select **Layout** from the drop-down list under **Orientation**. In the **Pages per Sheet** drop-down list, select the number of pages you want to print on one sheet of paper.

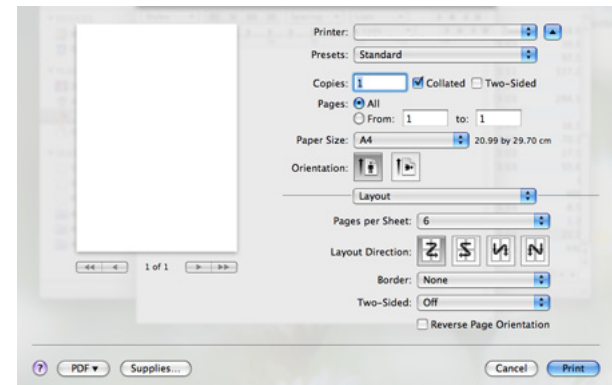

3. Select the other options you want to use.
4. Click **Print**, then the machine prints the selected the number of pages you want to print on one sheet of paper.

LINUX PRINTING

Printing from applications

There are several Linux applications that allow you to print using the Common UNIX Printing System (CUPS). You can print using any of these applications.

1. Open an application, and select **Print** from the **File** menu.
2. Select **Print** directly using LPR.

- From the LPR GUI window, select the model name of your machine from the printer list and click **Properties**.

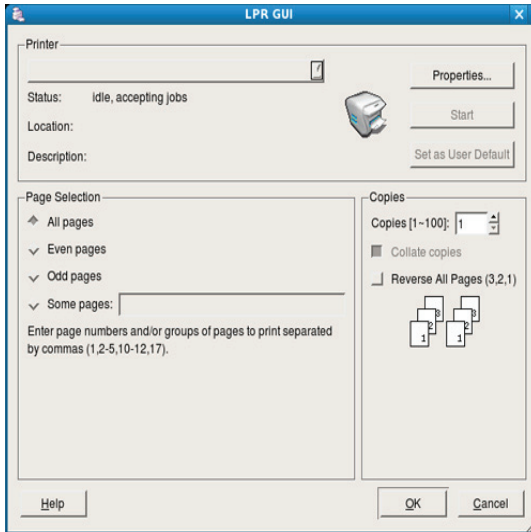

- Change the print job properties using the following four tabs displayed at the top of the window.

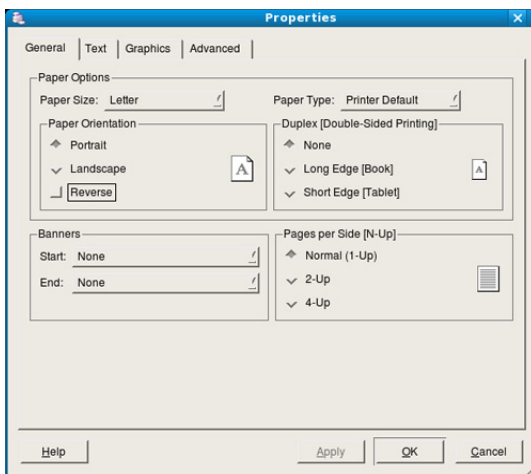

- General:** This option allows you to change the paper size, the paper type, and the orientation of the documents. It enables the duplex feature, adds start and end banners, and changes the number of pages per sheet.
- Text:** This option allows you to specify the page margins and set the text options, such as spacing or columns.
- Graphics:** This option allows you to set image options that are used when printing images/files, such as color options, image size, or image position.
- Advanced:** This option allows you to set the print resolution, paper source and special print features.

 If an option is grayed out, it means that the grayed out option is not supported by your machine.

- Click **Apply** to apply the changes and close the **Properties** window.
- Click **OK** in the **LPR GUI** window to start printing.
- The Printing window appears, allowing you to monitor the status of your print job.

To abort the current job, click **Cancel**.

Printing files

You can print many different types of files on your machine using the standard CUPS way, directly from the command line interface. The CUPS LPR utility allows you to do that. But the drivers package replaces the standard LPR tool by a much more user-friendly LPR GUI program.

To print any document file:

- Type `lpr <file_name>` from the Linux shell command line and press Enter. The **LPR GUI** window appears.
 - When you type only `lpr` and press **Enter**, the **Select file(s) to print** window appears first. Just select any files you want to print and click **Open**.
- From the **LPR GUI** window, select your machine from the list, and change the print job properties.
- Click **OK** to start printing.

Configuring printer properties

Using the **Printer Properties** window provided by the **Printers configuration**, you can change the various properties for your printer.

- Open the **Unified Driver Configurator**.
 - If necessary, switch to **Printers configuration**.
- Select your machine from the available printers list and click **Properties**.
- The **Printer Properties** window opens.

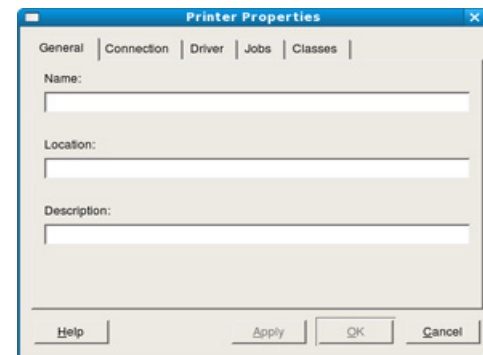

The following five tabs display at the top of the window:

- General:** This option allows you to change the printer location and name. The name entered in this tab displays on the printer list in **Printers configuration**.
 - Connection:** This option allows you to view or select another port. If you change the machine port from USB to parallel or vice versa while in use, you must re-configure the machine port in this tab.
 - Driver:** Allows you to view or select another printer driver. By clicking **Options**, you can set the default device options.
 - Jobs:** This option shows the list of print jobs. Click **Cancel job** to cancel the selected job and select the **Show completed jobs** check box to see previous jobs on the job list.
 - Classes:** This option shows the class that your machine is in. Click **Add to Class** to add your machine to a specific class or click **Remove from Class** to remove the machine from the selected class.
- Click **OK** to apply the changes and close the **Printer Properties** window.

This chapter gives you step-by-step instructions for copying documents.



This chapter includes:



- Basic copying
- Changing the settings for each copy

 When printing a fluorescent color, due to the property of the scanner, the result may differ from the original.

BASIC COPYING



The following is the normal procedure for copying your originals.

1. Place a single original face down on the scanner glass (See "Loading originals" on page 48).
2. Enter the number of copies using the +/- buttons if necessary.
 -  You can copy an original up to 99 pages at a time.
 - If you press +/- buttons short, the number of one's place appeared on the display increases or decreases one by one.
 - If you press +/- buttons long, the number of ten's place appeared on the display increases or decreases one by one.
3. If you want to customize the copy settings including **Darkness**, **Original Type** and more by using the Printer Settings Utility (See "Changing the settings for each copy" on page 62).
4. Press  **Start** button to begin copying.

 If you need to cancel the copying job during the operation, press  **Stop/Clear** button and the copying will stop.

CHANGING THE SETTINGS FOR EACH COPY

Your machine provides default settings for copying so that you can quickly and easily make a copy. However, if you want to change the options for each copy, use the Printer Settings Utility.

 If you press  **Stop/Clear** button on the control panel while setting the copy options, all of the options you have set for the current copy job will be canceled and returned to their default status. Or, they will automatically return to their default status after the machine completes the copy in progress.

Original Type

The original type setting is used to improve the copy quality by selecting the document type for the current copy job.

1. Double-click the Smart Panel icon on the Windows task bar (or Notification Area in Linux). You can also click Smart Panel on the status bar in Mac OS X. Or, if you are a Windows user, you can launch it from the **Start** menu, select **Programs** or **All Programs** > **Samsung Printers** > **your printer driver name** > **Smart Panel**.
2. Click **Printer Settings**.
3. Click **Copy** > **Original Type**. Select the appropriate value from the drop-down list, and then click **Apply**.
 - **Text**: Use for originals containing mostly text.
 - **Text/Photo**: Use for originals with mixed text and photographs.

- ID card copying

- **Photo**: Use when the originals are photographs.

Darkness

If you have an original containing faint marking and dark images, you can adjust the brightness to make a copy that is easier to read.

1. Double-click the Smart Panel icon on the Windows task bar (or Notification Area in Linux). You can also click Smart Panel on the status bar in Mac OS X. Or, if you are a Windows user, you can launch it from the **Start** menu, select **Programs** or **All Programs** > **Samsung Printers** > **your printer driver name** > **Smart Panel**.
2. Click **Printer Setting**.
3. Click **Copy** > **Darkness**. Select the appropriate value from the drop-down list, and then click **Apply**.
 - **Lightest**: Works well with lightest print.
 - **Light**: Works well with light print.
 - **Normal**: Works well with standard typed or printed originals.
 - **Dark**: Works well with dark print.
 - **Darkest**: Works well with darkest print.

Erasing background images

You can set the machine to print an image without its background. This copy feature removes the background color and can be helpful when copying an original containing color in the background such as a newspaper or a catalog.

1. Double-click the Smart Panel icon on the Windows task bar (or Notification Area in Linux). You can also click Smart Panel on the Status bar in Mac OS X. Or, if you are a Windows user, you can launch it from the **Start** menu, select **Programs** or **All Programs** > **Samsung Printers** > **your printer driver name** > **Smart Panel**.
2. Click **Printer Setting**.
3. Click **Copy** > **Auto Suppress Background**. Select the appropriate value from the drop-down list, and then click **Apply**.
 - **Off**: Does not use this feature.
 - **Auto**: Optimizes the background.

Setting the copy scan size

1. Double-click the Smart Panel icon on the Windows task bar (or Notification Area in Linux). You can also click Smart Panel on the status bar in Mac OS X. Or, if you are a Windows user, you can launch it from the **Start** menu, select **Programs** or **All Programs** > **Samsung Printers** > **your printer driver name** > **Smart Panel**.
2. Click **Printer Setting**.
3. Click **Copy** > **Copy Scan Size**. Select the appropriate value from the drop-down list, and then click **Apply**.

ID CARD COPYING

Your machine can print 2-sided originals on one sheet.

The machine prints one side of the original on the upper half of the paper and the other side on the lower half without reducing the size of the original. This feature is helpful for copying a small-sized item such as business card.

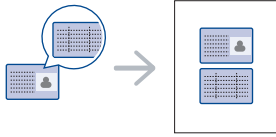



 The original must be placed on the scanner glass to use this feature.

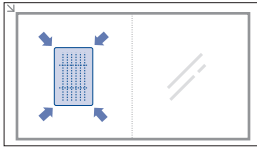

1. Place the front side of an original facing down on the scanner glass where arrows indicate as shown. Then, close the scanner lid.

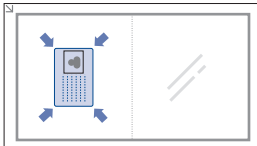

2. Press **ID Copy** button on the control panel.
Then, the **Front LED** on the control panel lights on.
3. Press  **Start** button on the control panel. Your machine begins scanning the front side of an original.
When scanning the front side of an original is finished the **Back LED** on the control panel lights on.
4. Turn the original over and place it on the scanner glass where arrows indicate as shown. Then, close the scanner lid.



5. Press  **Start** button on the control panel to begin scanning the back side of an original.
6. The machine prints both sides of an original without reducing its size.

-  • If you do not press  **Start** button, only the front side will be copied.
- If the original is larger than the printable area, some portions may not be printed.
 - If you press  **Stop/Clear** button, the copy job is canceled.

scanning

Scanning with your machine lets you turn pictures and text into digital files that can be stored on your computer.

This chapter includes:

- Basic scanning method
- Scanning originals and sending to your computer (Scan to PC)
- Using Samsung Scan and Fax manager
- Scanning with TWAIN-enabled software

 When scanning a fluorescent color, due to the property of the scanner, the result may differ from the original.

 The maximum resolution that can be achieved depends upon various factors, including a computer speed, available disk space, memory, the size of the image being scanned and color bit depth settings. Thus, depending on your system and what you are scanning, you may not be able to scan at a certain resolution, especially using enhanced resolution.

 Supported optional devices and features may differ according to your model. Check your model name (See "Features by Models" on page 18).

BASIC SCANNING METHOD

You can scan the originals with your machine via an USB cable or the network.

- **Samsung Scan and Fax Manager:** Scan the originals from the control panel. Then, the scanned data will be stored in the connected computers **My Documents** folder. When you install all the software in the supplied CD, the Samsung Scan and Fax Manager is also automatically installed on your computer. This feature can be used via the local connection or the network connection (See "Using Samsung Scan and Fax manager" on page 64).
- **TWAIN:** TWAIN is the one of a preset imaging applications. Scanning an image launches the selected application, enabling you to control the scanning process. This feature can be used via the local connection or the network connection (See "Scanning with TWAIN-enabled software" on page 65).
- **SmarThru:** This program is the accompanying software for your machine. You can use this program to scan images or documents. This feature can be used via the local connection or the network connection (See "SmarThru" on page 70).
- **WIA:** WIA stands for Windows Images Acquisition. To use this feature, your computer must be connected directly with the machine via an USB cable (See "Scanning using the WIA driver" on page 66).

SCANNING ORIGINALS AND SENDING TO YOUR COMPUTER (SCAN TO PC)

You can scan an image on the machine via the Samsung Scan and Fax Manager program that is installed in your USB connected computer.

 Scan to PC feature only works when your machine is connected via USB.

- Scanning using the WIA driver
- Macintosh scanning
- Linux Scanning

For USB connected machine

This is a basic scanning method for USB-connected machine.

1. Make sure that the machine is connected to your computer and powered on.
2. Place a single original face down on the scanner glass (See "Loading originals" on page 48).
3. Press **Scan to** button on the control panel.
4. Press  **Start** button on the control panel to begin scanning.

-  • Scanned image is saved in computer's **My Documents > My Pictures > Samsung** folder.
- You can use Twain driver to scan quickly in **Samsung Scan and Fax Manager** program.
 - From the **Start** menu, select **Programs** or **All Programs > Samsung Printers > Scan and Fax Manager > Scan and Fax Manager > Quick Scan**.

USING SAMSUNG SCAN AND FAX MANAGER

If you have installed the printer driver, the Samsung Scan and Fax Manager program is installed too. For program information and the scanner's status, start Samsung Scan and Fax Manager. With this program, you can change scan settings and add or delete the folders where scanned documents are saved in your computer.

 The Samsung Scan and Fax Manager program can only be used in the Windows and Mac OS system. If you use the Macintosh, click the following link ("Setting scan information in Scan and Fax Manager" on page 67).

1. From the **Start** menu, select **Programs** or **All Programs > Samsung Printers > Scan and Fax Manager > Scan and Fax Manager > Quick Scan**.

 You can open Samsung Scan and Fax Manager by right-clicking the Smart Panel icon in the Windows task bar and selecting Scan and Fax Manager.

2. Select the appropriate machine from the Samsung Scan and Fax Manager window.
3. Press **Properties**.
4. The **Set Scan Button** tab allows you to change the file saving destination and scan settings, to add or delete application program, and to change the file format to be saved.
You can change the scanning machine by using the **Change Port** tab (Local or Network).
5. When setting is done, press **OK**.

Set Scan Button tab

Scan Destination

- **Available Destination List:** Shows the list of applications currently linked to scanned images in the PC's registry. Select the program you want to use and click the right arrow and add to **Front Panel Destination List**.
- **Front Panel Destination List:** Shows the list of applications to open scanned image.
You can choose only one application to open scanned image from the **Available Destination List**.
- **Add Application:** Allows you to add application you want to use to **Available Destination List**.
- **Remove Application:** Allows you to remove an item added by the user in the **Available Destination List**.
- **File Format:** Allows you to select the form of scanned data to be saved. You can choose among **BMP, JPEG, PDF** and **TIFF**.

Scan Property

- **Computer ID:** Shows the ID of your computer.
- **Save Location:** Allows you to choose the location of the default saving folder.
- **Resolution:** Allows you to choose the scan resolution.
- **Scan Color:** Allows you to choose the scan color.
- **Scan Size:** Allows you to choose the scan size.
- **ADF Duplex:** Automatically scans both sides. If your model does not support this option, it will be grayed out.
- **Show Preview:** Checking this box allows you to preview applied scan options. You can modify the options before scanning.
- **Default:** Allows you to go back to default options.

Change Port tab

Local Scanner

Select when your machine is connected via USB port.

Network Scanner

Select when your machine is connected via network port.

- **Auto detection on the network:** Automatically detects your machine.
- **IP or Host name:** Enter in your machine's IP address to detect your machine.

Scan Assistant

When you press **Quick Scan** in Samsung Scan and Fax Manager, the **Scan Assistant** window appears. **Scan Assistant** allows you to adjust scan settings and start the scanning process.

- **Favorites:** Allows you to save the current preferences settings for future use. When you save **Favorites**, all current scan settings are saved. To use a saved setting, select it from the **Favorites** drop down list. The machine is now set to scan according to the setting you selected. To delete saved setting, select it from the **Favorites** drop down list and click **Delete**. To set a favorite as startup, select the favorite you want to set as startup, then click the **Set as default** button.
- **Scan settings:** The following scan options are available.
 - **Image Type:** Allows you to choose the proper color settings for image scanning.
 - **Resolution:** Allows you to choose the image resolution.

- **Document Size:** Allows you to choose the proper size of the scanned image.
- **Document Source:** Allows you to choose the device (scan glass) you want to scan with.
- **Prompt for additional pages:** If this check box is checked, you can scan pages continuously. This option is useful when you scan multi-page documents and/or when **Document Source** is set to **Flatbed** (platen glass). In this case a sequence of scanned images is processed as a single document.
- **Pages to Scan:** Allows you to specify how many pages are to be scanned. This option is available when **Document Source** is set to **ADF**(Document feeder).
- **Preference:** The following scan options are available.
 - **Auto crop image after preview:** If this option is checked, the scanning area will be automatically adjusted to the image size.
 - **Preview on program start:** If this option is checked, the scanning area will be selected automatically as shown in the preview.
 - **Blank page detection:** This operation automatically detects whether the scanned image is blank or not.
 - **Delete page:** Blank pages will be deleted at the end of the scanning process.
 - **Separate files:** Blank page will work as a scan job separator. That is, when multiple pages are scanned at once a blank page will divide scanned image sequence into parts. Each part will be treated as a separate document (group).
 - **Start from scanner:** If this option is checked, scanning process is managed using scanner touch screen rather than from the computer. The option is not available for some scanner models.
- **Advanced:** In the **Advanced** mode, additional options such as **Image Adjustment, Image Enhancement, and Additional Settings** are available.
 - **Image Adjustment:** Allows you to perform some transformations of the scanned image. These transformations include automatic adjustment of image size, straightening and rotation.
 - **Image Enhancement:** Allows you to remove various defects of the image and improve its quality.
 - **Additional settings:** Allows special processing of scanned images. These transformations include stitching several partial image scans into a single image, processing of scanned books and watermark stamping.



Click the **Help** button from the lower-left corner of the window and click on any option you want to know about. Then a pop up window appears with information about that option's feature which is provided from the **Scan Assistant**.

SCANNING WITH TWAIN-ENABLED SOFTWARE

If you want to scan documents using other software, you will need to use TWAIN-compliant software such as Adobe Photoshop.

Follow the steps below to scan with TWAIN-compliant software.

1. Make sure that the machine is connected to your computer and powered on.
2. Place a single original face down on the scanner glass (See "Loading originals" on page 48).
3. Open an application such as Adobe Photoshop.
4. Open the TWAIN window and set the scan options.
5. Scan and save your scanned image.

SCANNING USING THE WIA DRIVER

Your machine also supports the Windows Image Acquisition (WIA) driver for scanning images. WIA is one of the standard components provided by Microsoft Windows XP and works with digital cameras and scanners. Unlike the TWAIN driver, the WIA driver allows you to scan and easily adjust images without using additional software.



- The WIA driver works only on Windows XP/Vista/7 with a USB port.
- Depending on the selected **Control Panel** view, the path may differ.

Windows XP

1. Make sure that the machine is connected to your computer and powered on.
2. Place a single original face down on the scanner glass (See "Loading originals" on page 48).
3. From the **Start** menu, select **Control Panel > Scanners and Cameras**.
4. Double-click your scanner driver icon. The **Scanner and Camera wizard** appears.
5. Click **Next**.
6. Set the option in **Choose scanning preferences** window and click **Preview** to see how your options affect the picture.
7. Click **Next**.
8. Enter a picture name, and select a file format and destination to save the picture.
9. Your picture has been successfully copied to your computer. Choose one of the options on screen.
10. Click **Next**.
11. Click **Finish**.

Windows Vista

1. Make sure that the machine is connected to your computer and powered on.
2. Place a single original face down on the scanner glass (See "Loading originals" on page 48).
3. From the **Start** menu select **Control Panel > Hardware and Sound > Scanners and Cameras**.
4. Double-click **Scan a document or picture**. **Windows Fax and Scan** application appears.
 - You can click on **View scanners and cameras** to view scanners,
 - If there is no **Scan a document or picture**, open the MS paint program and from the **File** click **From Scanner or Camera...**
5. Click **New Scan**. Scan driver appears.
6. Choose your scanning preferences and click **Preview** to see your preferences affect the picture.
7. Click **Scan**.



- If you want to cancel the scan job, press **Cancel** button on the **Scanner and Camera wizard**.

Windows 7

1. Make sure that the machine is connected to your computer and powered on.
2. Place a single original face down on the scanner glass (See "Loading originals" on page 48).

3. From the **Start** menu select **Control Panel > Hardware and Sound > Devices and Printers > Printers and Faxes**.
4. Click right button of mouse on device driver icon and select **Start Scan**. **New Scan** application appears.
5. Choose your scanning preferences and click **Preview** to see your preferences affect the picture.
6. Click **Scan**.

MACINTOSH SCANNING

You can scan documents using **Image Capture** program. Mac OS offers **Image Capture** program.

Scanning with USB

1. Make sure that the machine is connected to your computer and powered on.
2. Place a single original face down on the scanner glass (See "Loading originals" on page 48).
3. Start **Applications** and click **Image Capture**.
 - If **No camera or scanner connected** message appears, disconnect the USB cable and reconnect it. If the problem persists, refer to the **Image Capture's** help.
4. Set the scan options on this program.
5. Scan and save your scanned image.
 - For more information about using **Image Capture**, refer to the **Image Capture's** help.
 - Use TWAIN-compliant software to apply more scan options.
 - You can also scan using TWAIN-compliant software, such as Adobe Photoshop.
 - Scan process differ according to TWAIN-compliant software. Please refer to the user's guide of the software.
 - If scanning does not operate in **Image Capture**, update Mac OS to the latest version. **Image Capture** operates properly in Mac OS X 10.3.9 or higher and Mac OS X 10.4.7 or higher.

Scanning with network (SCX-3205W(K) only)

1. Make sure that the machine is connected to your computer and powered on.
2. Place a single original face down on the scanner glass (See "Loading originals" on page 48).
3. Start **Applications** and click **Image Capture**.
4. For Mac OS X 10.4 ~ 10.5
Click **Devices** and click **Browse Devices**.
For Mac OS X 10.6
Select your device below **SHARED**. Skip to step 7.
5. For Mac OS X 10.4
Select your machine in TWAIN devices option. Make sure that **Use TWAIN software** check box is checked, and click **Connect**.
 - If a warning message appears, click **Change Port..** to select port.
 - If TWAIN UI appears, from the **Preference** tab, click **Change Port..** to select port.



- Refer to scan manager for **Change port..** use (See "Setting scan information in Scan and Fax Manager" on page 67).

For Mac OS X 10.5

Make sure that **Connected** check box is checked beside your machine

in Bonjour Devices.

If you want to scan using TWAIN, refer to the Mac OS X 10.4 steps above.

6. Set the scan options on this program.
7. Scan and save your scanned image.



- For Mac OS X 10.3, use TWAIN-compliant software.
- For more information about using **Image Capture**, refer to the **Image Capture**'s help.
- Use TWAIN-compliant software to apply more scan options.
- You can also scan using TWAIN-compliant software, such as Adobe Photoshop.
- Scan process differ according to TWAIN-compliant software. Please refer to the user's guide of the software.
- If scanning does not operate in **Image Capture**, update Mac OS to the latest version. **Image Capture** operates properly in Mac OS X 10.4.7 or higher.

Setting scan information in Scan and Fax Manager

When you want to find out about Scan and Fax Manager program information, to check the installed scan driver's condition, to change scan settings and to add or delete the folders where scanned documents to computer are saved in Scan and Fax Manager program, follow the below steps.

1. From the Smart Panel menu on Status bar, click Scan and Fax Manager.
2. Select the appropriate machine from the Scan and Fax Manager.
3. Press **Properties**.
4. Use **Set Scan Button** to change the file destination or scan settings, to add or delete application programs, and to format files. You can change the scanning machine by using **Change Port** (Local or Network).
5. When done, press **OK**.

LINUX SCANNING

You can scan a document using the Unified Driver Configurator window.

Scanning

1. Double-click the **Unified Driver Configurator** on your desktop.
2. Click the  button to switch to Scanners configuration.
3. Select the scanner on the list.

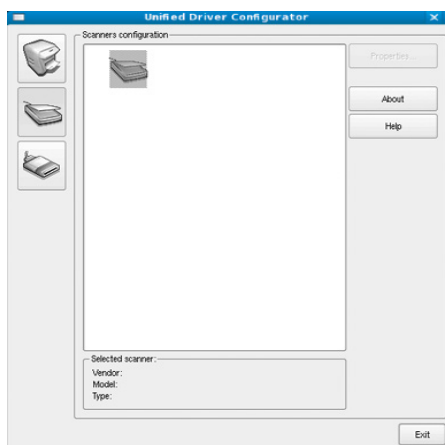

If you use only one machine device and it is connected to the computer and turned on, your scanner appears on the list and is automatically selected.

If you have two or more scanners connected to your computer, you can select any scanner to work at any time. For example, while acquisition is in progress on the first scanner, you may select the second scanner, set the device options and start the image acquisition simultaneously.

4. Click **Properties**.
5. Place a single original face down on the scanner glass (See "Loading originals" on page 48).
6. From the **Scanner Properties** window, click **Preview**.
The document is scanned and the image preview appears in the **Preview Pane**.

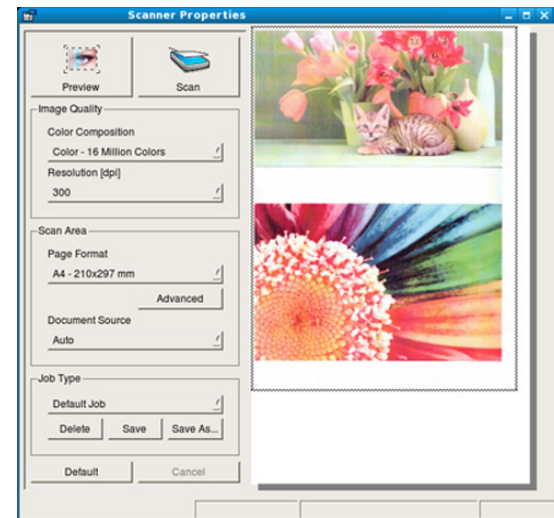

7. Drag the pointer to set the image area to be scanned in the **Preview Pane**.
 8. Change the scan options in the **Image Quality** and **Scan Area** sections.
 - **Image Quality:** This option allows you to select the color composition and the scan resolution for the image.
 - **Scan Area:** This option allows you to select the page size. The **Advanced** button enables you to set the page size manually.
- If you want to use one of the preset scan option settings, select the option from the **Job Type** drop-down list (See "Adding Job Type Settings" on page 67).
- Click **Default** to restore the default setting for the scan options.
9. When you have finished, click **Scan** to start scanning.
The status bar appears on the bottom left of the window to show you the progress of the scan. To cancel scanning, click **Cancel**.
 10. The scanned image appears.
If you want to edit the scanned image, use the toolbar (See "Using the Image Manager" on page 68).
 11. When you are finished, click **Save** on the toolbar.
 12. Select the file directory where you want to save the image and enter the file name.
 13. Click **Save**.

Adding Job Type Settings

You can save your scan option settings for later use.

To save a new Job Type setting

1. Change the options from the Scanner Properties window.
2. Click **Save As**.
3. Enter the name for your setting.
4. Click **OK**.

Your setting is added to the **Saved Settings** drop-down list.

To save a Job Type setting for the next scan job

1. Select the setting you want to use from the **Job Type** drop-down list.
2. The next time you open the **Scanner Properties** window, the saved setting is automatically selected for the scan job.

To delete a Job Type setting







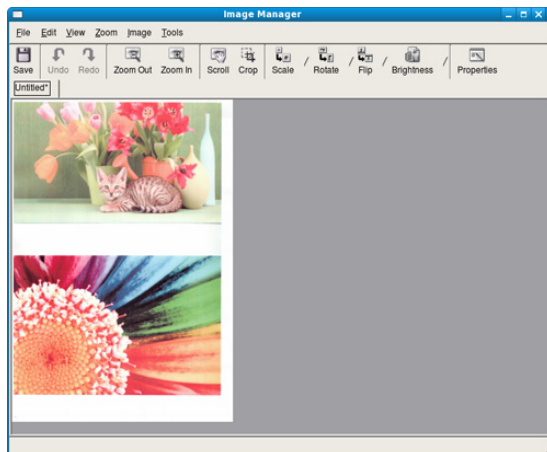





1. Select the setting you want to delete from the **Job Type** drop-down list.
2. Click **Delete**.
The setting is deleted from the list.

Using the Image Manager

The Image Manager application provides you with menu commands and tools to edit your scanned image.



Use the following tools to edit the image.

TOOLS	NAME	FUNCTION
	Save	Saves the image.
	Undo	Cancels your last action.
	Redo	Restores the action you canceled.
	Scroll	Allows you to scroll through the image.
	Crop	Crops the selected image area.
	Zoom Out	Zooms the image out.
	Zoom In	Zooms the image in.
	Scale	Allows you to scale the image size; you can enter the size manually, or set the rate to scale proportionally, vertically, or horizontally.
	Rotate	Allows you to rotate the image; you can select the number of degrees from the drop-down list.
	Flip	Allows you to flip the image vertically or horizontally.
	Brightness	Allows you to adjust the brightness or contrast of the image, or to invert the image.
	Properties	Shows the properties of the image.

For further details about the Image Manager application, refer to the on screen help.

management tools

This chapter introduces management tools provided to help you make full use of your machine.

This chapter includes:

- Introducing useful management tools
- Using SyncThru™ Web Service (SCX-3205W(K) only)
- Using the Smart Panel program

 Supported optional devices and features may differ according to your model. Check your model name (See "Features by Models" on page 18).

INTRODUCING USEFUL MANAGEMENT TOOLS

The programs below help you to use your machine conveniently.

- "Using SyncThru™ Web Service (SCX-3205W(K) only)" on page 69.
- "Using the Smart Panel program" on page 70.
- "SmarThru" on page 70.
- "Using the Linux Unified Driver Configurator" on page 71.

USING SYNCTHRU™ WEB SERVICE (SCX-3205W(K) ONLY)

 Internet Explorer® 6.0 or higher is the minimum requirement for SyncThru™ Web Service.

If you have connected your machine to a network and set up TCP/IP network parameters correctly, you can manage the machine via SyncThru™ Web Service, an embedded web server. Use SyncThru™ Web Service to:

- View the machine's device information and check its current status.
- Change TCP/IP parameters and set up other network parameters.
- Change printer preference.
- Set the email notifications advising of the machine's status.
- Get support for using the machine.

To access SyncThru™ Web Service

1. Access a web browser, such as Internet Explorer, from Windows. Enter the machine IP address (<http://xxx.xxx.xxx.xxx>) in the address field and press the Enter key or click **Go**.
2. Your machine's embedded website opens.

Logging into SyncThru™ Web Service

Before configuring options in SyncThru™ Web Service, you need to log-in as an administrator. You can still use SyncThru™ Web Service without logging in but you won't have access to **Settings** tab and **Security** tab.

1. Click **Login** on the upper right of the SyncThru™ Web Service website.
The **Login** window appears.
2. Type in the **ID** and **Password** then click **Login**.
If it's your first time logging into SyncThru™ Web Service, type in the below default ID and password.
 - **ID: admin**

- SmarThru
- Using the Linux Unified Driver Configurator

- **Password: sec00000**

SyncThru™ Web Service overview



 Some tabs may not appear depending on your model.

Information tab

This tab gives you general information about your machine. You can check things, such as remaining amount of toner. You can also print reports such as an error report and so on.

- **Active Alerts:** This item allows you to check the alerts occurred in the machine and their severity.
- **Supplies:** This item allows you to check how many pages are printed and amount of toner left in the cartridge.
- **Usage Counters:** This item allows you to check the usage count by print types: simplex, duplex.
- **Current Settings:** This item allows you to check the machine and network information.
- **Print information:** This item allows you to print reports such as system related reports, e-mail address and font reports.

Settings tab

This tab allows you to set configurations provided by your machine and network. You need to log-in as an administrator to view this tab.

- **Machine Settings tab:** This tab allows you to set options provided by your machine.
 - **System:** You can set settings related to your machine.
 - **Printer:** You can set settings related to printing jobs.
 - **Copy:** You can set settings related to copying jobs.
- **Network Settings tab:** This tab allows you to view and change the network environment. You can set things, such as TCP/IP, network protocols and so on.
 - **Restore Default:** You can restore default network settings.

Security tab

This tab allows you to set system and network security information. You need to log-in as an administrator to view this tab.

- **System Security:** You can set the system administrator's information.
- **Network Security:** You can set settings for IPv4/IPv6 filtering, 802.1x, Authentication servers.

Maintenance tab

This tab allows you to maintain your machine by upgrading firmware and setting contact information for sending emails. You can also connect to Samsung website or download drivers by selecting the **Link** menu.

- **Firmware Upgrade:** You can upgrade your machine's firmware.
- **Contact Information:** You can view the contact information.
- **Link:** You can view the links to useful sites where you can download or check information.

USING THE SMART PANEL PROGRAM

The Smart Panel is a program that monitors and informs you of the machine status, and allows you to customize the machine's settings. For Windows and Macintosh, Smart Panel is installed automatically when you install the machine software. For Linux, you can download Smart Panel from the Samsung website and install (See "Installing the Smart Panel" on page 28).

To use this program, your computer has to meet the following system requirements:



- Windows. Check that your computer's CPU, RAM and HDD meet or exceed specification (See "System requirements" on page 25).
- Mac OS X 10.3 or higher. Check that your computer's CPU, RAM and HDD meet or exceed specification (See "System requirements" on page 25).
- Linux. Check that your computer's CPU, RAM and HDD meet or exceed specification (See "System requirements" on page 25).
- Internet Explorer version 5.0 or higher for flash animation in HTML Help.

If you need to know the exact model name of your machine, you can check the supplied software CD.

Understanding Smart Panel

If an error occurs while operating, you can check the error from the Smart Panel.

You can also launch Smart Panel manually. Double-click the Smart Panel icon on the Windows task bar (in Windows), or Notification Area (in Linux). You can also click it on the status bar (in Mac OS X).

Windows		Double-click this icon in Windows.
Macintosh		Click this icon in Mac OS X.
Linux		Click this icon in Linux.



Or, if you are a Windows user, you can launch it from the **Start** menu, select **Programs** or **All Programs** > **Samsung Printers** > **your printer driver name** > **Smart Panel**.

- If you have already installed more than one Samsung machine, first select the correct machine model you want in order to access the corresponding Smart Panel.
Right-click (in Windows or Linux) or click (in Mac OS X) the Smart Panel icon and select your machine.
- The Smart Panel window and its contents shown in this user's guide may differ depending on the machine or operating system in

use.

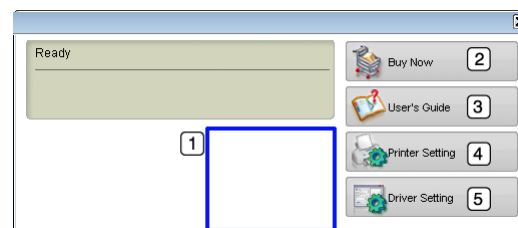
The Smart Panel program displays the current status of the machine, the estimated level of toner remaining in each toner cartridge, and various other types of information. You can also change settings.



1	Toner Level	You can view the level of toner remaining in each toner cartridge. The machine and the number of toner cartridge(s) shown in the above window may differ depending on the machine in use. Some machines do not have this feature.
2	Buy Now	You can order replacement toner cartridge(s) from online.
3	User's Guide	You can view the online User's Guide.  This button changes to Troubleshooting Guide when error occurs. You can directly open the troubleshooting section in the user's guide.
4	Printer Setting	You can configure various machine settings in the Printer Settings Utility window. Some machines do not have this feature.  If you connect your machine to a network, the SyncThru™ Web Service window appears instead of the Printer Settings Utility window.
5	Driver Setting	You can set all of the machine options you need in the Printing Preferences window. This feature is available only for Windows (See "Opening printing preferences" on page 55).

Changing the Smart Panel Program Settings

Right-click (in Windows or Linux) or click (in Mac OS X) the Smart Panel icon and select **Options**. Select the settings you want from the **Options** window.

SMARTHRU

The supplied software CD provides you with SmarThru. SmarThru offers you convenient features to use with your machine.

Starting SmarThru

Follow the steps below to start SmarThru.

1. Make sure that your machine and computer are turned on and properly connected to each other.
2. Once you have installed SmarThru, you will see the SmarThru icon on your desktop.

3. Double-click the SmarThru icon.



4. The SmarThru appears.

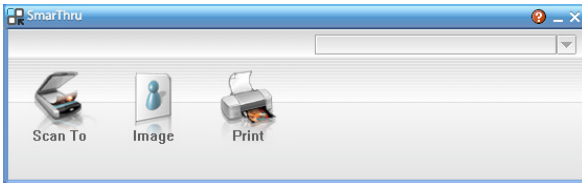

- **Scan to:** Allows you to scan an image and save it to an application or folder, email it, or publish it on a website.
- **Image:** Allows you to edit an image you have saved as a graphic file and send it to a selected application or folder, email it, or publish it on a website.
- **Print:** Allows you to print images you have saved. You can print images in black and white or color mode if your machine supports it.

For more information about SmarThru, click  at the top right corner of the window. The SmarThru help window appears; you can view on screen help supplied on the SmarThru program.

-  Follow the steps below to uninstall SmarThru. Before you begin the uninstall, ensure that all applications are closed on your computer.
- a) From the **Start** menu, select **Programs** or **All Programs**.
 - b) Select **Samsung Printers > SmarThru 4 > Uninstall SmarThru 4**.
 - c) When your computer asks you to confirm your selection, read the statement and click **OK**.
 - d) Click **Finish**.

Using SmarThru

Scanning

1. Click **Scan To**.

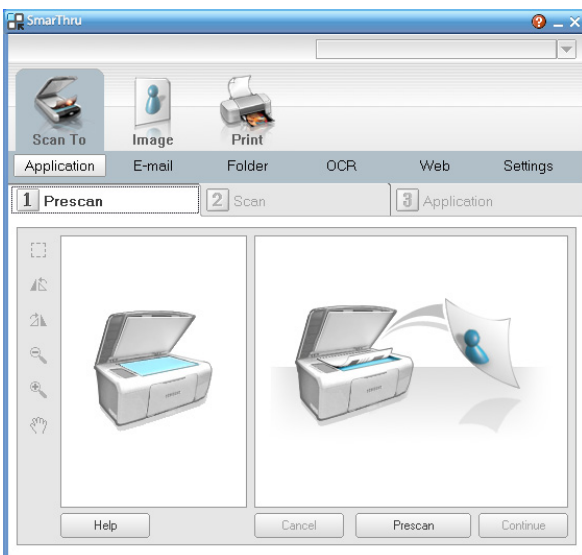

- **Application:** Scanning an image and placing it in an image editor application such as Paint or Adobe Photoshop.

- **E-mail:** Scanning an image and emailing it. Allows you to scan an image, preview it, and email it.
 -  To send an image by e-mail, you must have a mail client program, like Outlook Express, which has been set up with your e-mail account.
- **Folder:** Scanning an image and saving it to a folder. Allows you to scan an image, preview it, and save it to the folder of your choice.
- **OCR:** Scanning an image and performing text recognition. Allows you to scan an image, preview it, and send it to the OCR program for text recognition.
 - Recommended scan option for OCR.
 - Resolution: 200 or 300 dpi.
 - Image type: grayscale or black & white.
- **Web:** Scanning an image, previewing it, and publishing it on a website, using the specified file format for the image you want to publish.
- **Settings:** Customizing settings of **Scan To** basic functions. Allows you to customize settings for **Application**, **E-mail**, **OCR**, and **Web** functions.

2. Set scan settings and click **Scan**.

Printing

1. Click **Print**.
2. Select the file you want to print.
3. Select the machine you want to use for printing.
4. Click **Print** to start the job.

USING THE LINUX UNIFIED DRIVER CONFIGURATOR

The Unified Driver Configurator is a tool primarily intended for configuring machine devices. You need to install Unified Linux Driver to use Unified Driver Configurator (See "Installing the Unified Linux Driver" on page 28).

After the driver is installed on your Linux system, the Unified Driver Configurator icon will automatically be created on your desktop.

Opening the Unified Driver Configurator

1. Double-click the **Unified Driver Configurator** on the desktop. You can also click the **Startup Menu** icon and select **Samsung Unified Driver > Unified Driver Configurator**.
2. Click each button on the left to switch to the corresponding configuration window.

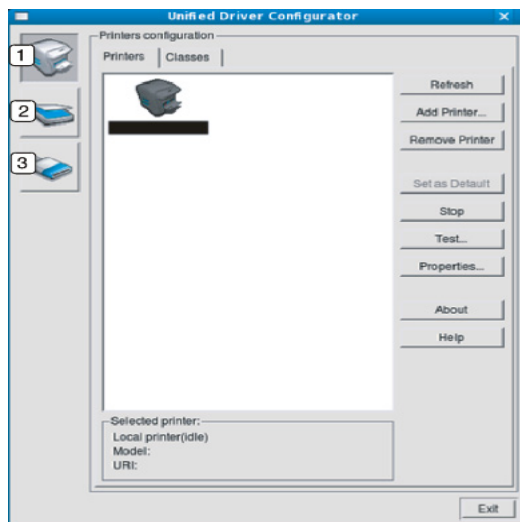

-
- 1 Printers Configuration

 - 2 Scanners Configuration

 - 3 Ports Configuration

 To use the on screen help, click **Help**.

3. After changing the configurations, click **Exit** to close the Unified Driver Configurator.

Printers configuration window

Printers configuration has the two tabs: **Printers** and **Classes**.

Printers tab

View the current system's printer configuration by clicking on the machine icon button on the left side of the Unified Driver Configurator window.

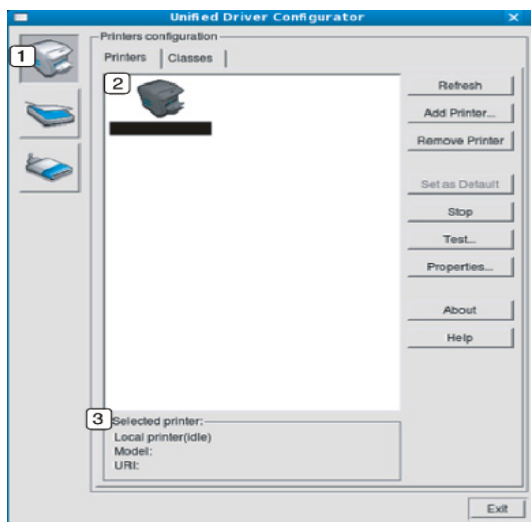

-
- 1 Switches to **Printers** configuration.

 - 2 Shows all of the installed machine.

 - 3 Shows the status, model name and URL of your machine.

The printer control buttons are as follows:

- **Refresh:** Renews the available machines list.
- **Add Printer:** Allows you to add a new machines.

- **Remove Printer:** Removes the selected machine.
- **Set as Default:** Sets the current selected machine as a default machine.
- **Stop/Start:** Stops/starts the machine.
- **Test:** Allows you to print a test page to ensure the machine is working properly.
- **Properties:** Allows you to view and change the printer properties.

Classes tab

The Classes tab shows a list of available machine classes.

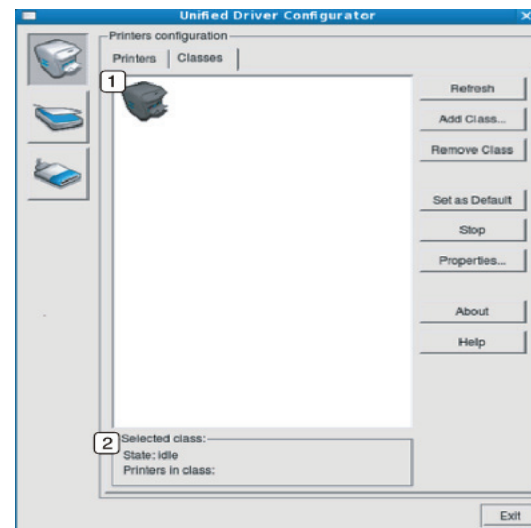

-
- 1 Shows all of the machine classes.

 - 2 Shows the status of the class and the number of machines in the class.
 - **Refresh:** Renews the classes list.
 - **Add Class:** Allows you to add a new machine class.
 - **Remove Class:** Removes the selected machine class.

Scanners configuration

In this window, you can monitor the activity of scanner devices, view a list of installed Samsung machine devices, change device properties, and scan images.

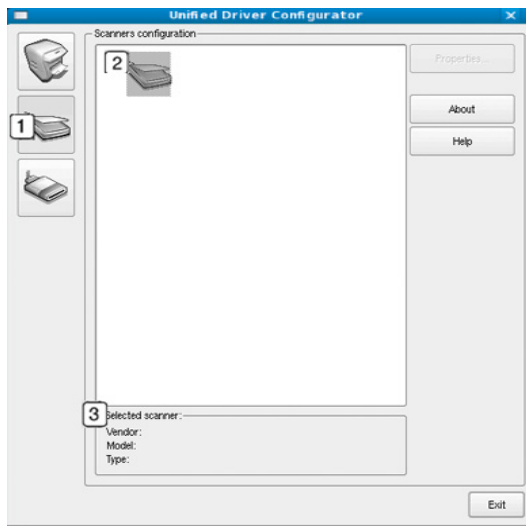

- 1 Switches to **Scanners configuration**.
- 2 Shows all of the installed scanners.
- 3 Shows the vendor, model name and type of your scanner.

- **Properties:** Allows you to change the scan properties and scan a document.

Ports configuration

In this window, you can view the list of available ports, check the status of each port, and release a port that is stalled in a busy state when its owner has terminated the job for any reason.

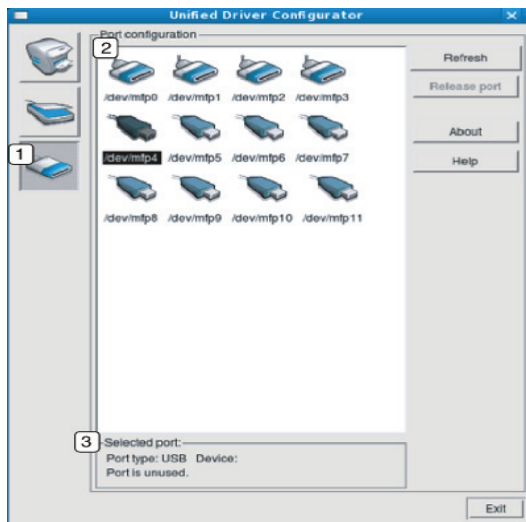

- 1 Switches to **Ports configuration**.
- 2 Shows all of the available ports.

- 3 Shows the port type, device connected to the port, and status.

- **Refresh:** Renews the available ports list.
- **Release port:** Releases the selected port.

Sharing Ports Between Printers and Scanners

Your machine may be connected to a host computer via a parallel port or USB port. Since the machine device contains more than one device (printer and scanner), it is necessary to organize proper access of “consumer” applications to these devices via the single I/O port.

The Unified Linux Driver package provides an appropriate port sharing mechanism that is used by Samsung printer and scanner drivers. The drivers talk to their devices via so-called machine ports. The current status of any machine port can be viewed via the **Ports configuration**. The port sharing prevents you from accessing one functional block of the machine device, while another block is in use.

When you install a new machine device onto your system, it is strongly recommended you do this with the assistance of an Unified Driver Configurator. In this case you will be asked to choose I/O port for the new device. This choice will provide the most suitable configuration for machine’s functionality. For machine scanners, I/O ports are being chosen by scanner drivers automatically, so proper settings are applied by default.

maintenance

This chapter provides information about maintaining your machine and the toner cartridge.

This chapter includes:

- Printing a machine report
- Cleaning the machine

PRINTING A MACHINE REPORT

You can print a configuration page to view current printer settings, or to help troubleshoot printer problems.

In ready mode, press and hold  **Stop/Clear** button for about two seconds, then release.

A configuration page prints out.

CLEANING THE MACHINE

If printing quality problems occur or if you use your machine in a dusty environment, you need to clean your machine regularly to keep the most optimum print quality.



- Cleaning the cabinet of the machine with cleaning materials containing large amounts of alcohol, solvent or other strong substances can discolor or distort the cabinet.
- If your machine or the surrounding area is contaminated with toner, we recommend that you use a cloth or tissue dampened with water to clean it. If you use a vacuum cleaner, toner blows in the air and might be harmful if inhaled.

Cleaning the outside

Clean the machine cabinet with a soft and lint-free cloth. Dampen the cloth slightly with water, but be careful not to let any water drip onto or into the machine.

Cleaning the inside

During the printing process, paper, toner and dust particles can accumulate inside the machine. This buildup can cause print quality problems such as toner specks or smearing. Cleaning the inside of the machine clears and reduces these problems.

- Storing the toner cartridge
- Tips for moving & storing your machine

1. Turn the machine off and unplug the power cord. Wait for the machine to cool down.
2. Open the scan unit.

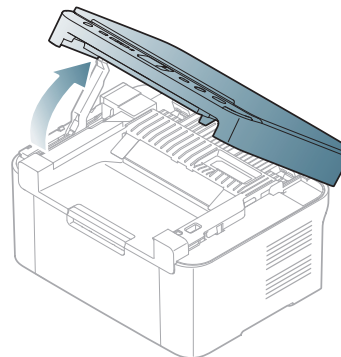

3. Open the inner cover.

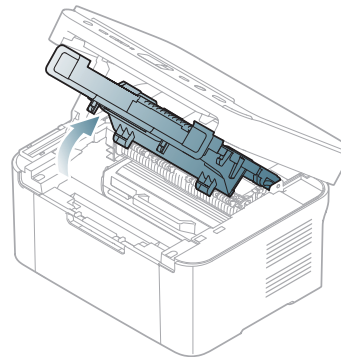

4. Pull the toner cartridge out.

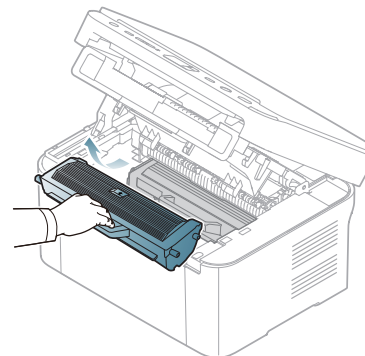

- To prevent damage to the toner cartridge, do not expose it to light for more than few minutes. Cover it with a piece of paper, if necessary.

- Do not touch the green surface of the drum located in the toner cartridge or imaging unit. Use the handle on the cartridge to avoid touching this area.
5. With a dry and lint-free cloth, wipe away any dust and spilled toner from the toner cartridges area.

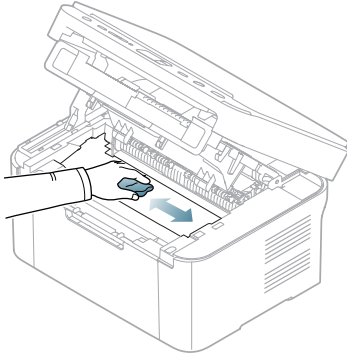

! While cleaning the inside of the machine, be careful not to damage the transfer roller or any other inside parts. Do not use solvents such as benzene or thinner to clean. Printing quality problems can occur and cause damage to the machine.

✓ After cleaning, let the machine to dry completely.

6. Reinsert the toner cartridge.

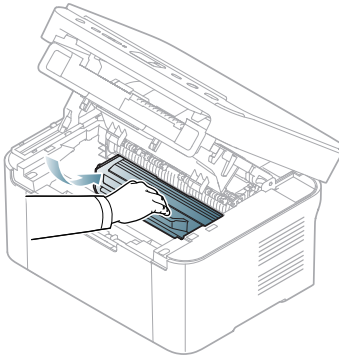

7. Close the inner cover and the scan unit completely in order.
8. Plug in the power cord and turn the machine on.

Cleaning the scan unit

Keeping the scan unit clean helps ensure the best possible copies. We suggest that you clean the scan unit at the start of each day and during the day as needed.

1. Slightly dampen a soft, lint-free cloth or paper towel with water.
2. Open the scanner lid.

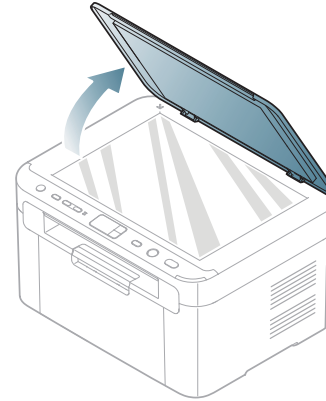

3. Wipe the surface of the scanner glass until it is clean and dry.

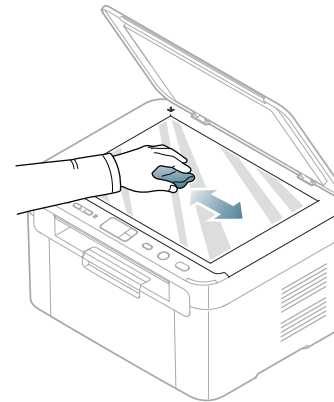

4. Close the scanner lid.

STORING THE TONER CARTRIDGE

Toner cartridge storage

Toner cartridges contain components that are sensitive to light, temperature, and humidity. Samsung suggests users follow the recommendations to ensure the optimum performance, highest quality, and longest life from your new Samsung toner cartridge.

Store this cartridge in the same environment as the printer it will be used in; this should be in controlled office temperature and humidity conditions. The toner cartridge should remain in its original, unopened package until installation – If original packaging is not available, cover the top opening of the cartridge with paper and store in a dark cabinet.

Opening the cartridge package prior to use dramatically shortens its useful shelf and operating life. Do not store on the floor. If the toner cartridge is removed from the printer, always store the cartridge according to the following guidelines:

- Inside the protective bag from the original package.
- Store lying flat (not standing on end) with the same side facing up as if was installed in the machine.
- Do not store consumable in any of the following conditions:
 - Temperature greater than 40°C (104°F).
 - Humidity range less than 20% and not greater than 80%.
 - An environment with extreme changes in humidity or temperature.
 - Direct sunlight or room light.

- Dusty places.
- A car for a long period of time.
- An environment where corrosive gases are present.
- An environment with salty air.

Handling instructions

- Do not touch the surface of the photoconductive drum in the cartridge.
- Do not expose the cartridge to unnecessary vibrations or shock.
- Never manually rotate the drum, especially in the reverse direction; this can cause internal damage and toner spillage.

Use of non-Samsung and refilled toner cartridge

Samsung Electronics does not recommend or approve the use of non-Samsung brand toner cartridges in your printer including generic, store brand, refilled, or remanufactured toner cartridges.



Samsung's printer warranty does not cover damage to the machine caused by the use of a refilled, remanufactured, or non-Samsung brand toner cartridge.

Estimated cartridge life

Estimated cartridge life (the life of the toner cartridge yield) depends on the amount of toner that print jobs require. The actual print yield may vary depending on the print density of the pages you print on, operating environment, printing interval, media type, and/or media size. For example, if you print a lot of graphics, the consumption of the toner is high and you may need to change the cartridge more often.

TIPS FOR MOVING & STORING YOUR MACHINE

- When moving the machine, do not tilt or turn it upside down. Otherwise, the inside of the machine may be contaminated by toner, which can cause damage to the machine or reduce print quality.

troubleshooting

This chapter gives helpful information for what to do if you encounter an error.

This chapter includes:

- Redistributing toner
- Tips for avoiding paper jams

REDISTRIBUTING TONER

When the toner cartridge is near the end of its life:

- White streaks or light printing occurs.
- The **Status LED** blinks red.

If this happens, you can temporarily improve print quality by redistributing the remaining toner in the cartridge. In some cases, white streaks or light printing will still occur even after you have redistributed the toner.

1. Open the scan unit.

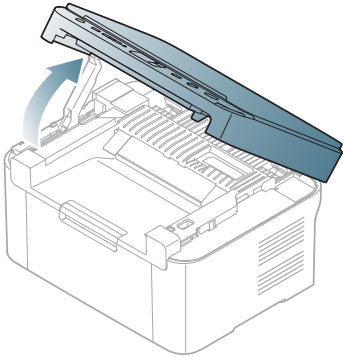

2. Open the inner cover.

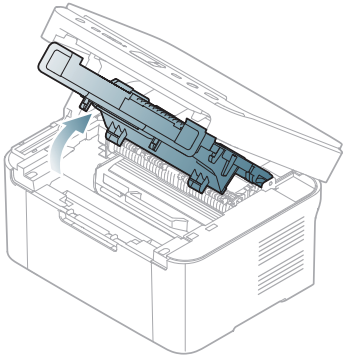

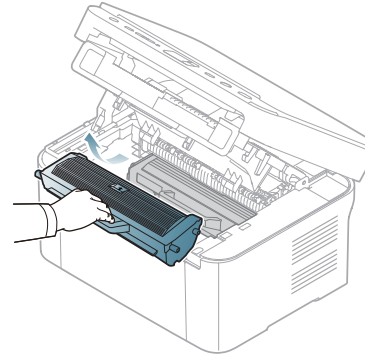

- Clearing paper jams
- Solving other problems

3. Pull the toner cartridge out.

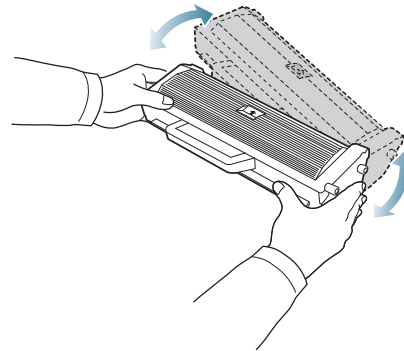

4. Thoroughly roll the cartridge five or six times to distribute the toner evenly inside the cartridge.



 If toner gets on your clothing, wipe it off with a dry cloth and wash clothing in cold water. Hot water sets toner into fabric.

 Do not touch the drum in the toner cartridge or imaging unit. Use the handle on the cartridge to avoid touching this area.

5. Hold the toner cartridge by the handle and slowly insert the cartridge into the opening in the machine.

The tabs on the sides of the cartridge and corresponding grooves within the machine will guide the cartridge into the correct position until it locks

into place completely.

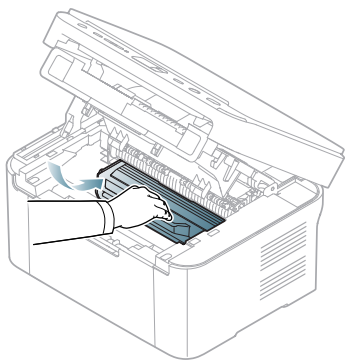

6. Close the inner cover and the scan unit completely in order. Ensure that they are securely closed.

TIPS FOR AVOIDING PAPER JAMS

By selecting the correct media types, most paper jams can be avoided. When a paper jam occurs, refer to the guidelines below:

- Ensure that the adjustable guides are positioned correctly (See "Loading paper in the tray" on page 50).
- Do not overload the tray. Ensure that the paper level is below the paper capacity mark on the inside of the tray.
- Do not remove paper from the tray while your machine is printing.
- Flex, fan, and straighten paper before loading.
- Do not use creased, damp, or highly curled paper.
- Do not mix paper types in a tray.
- Use only recommended print media.
- Ensure that the recommended side of the print media is facing the right side (See "Loading paper in the tray" on page 50).
- If duplexing, print one sheet at a time using **Start** button (See "Printing on both sides of the paper (Manual)" on page 56).
- If you are printing on a special paper, print one sheet at a time using **Start** button (See "Manual feeding in the tray" on page 50).

CLEARING PAPER JAMS

If a paper jam occurs, the **Status LED** on the control panel lights orange. Find and remove the jammed paper.

-  To avoid tearing the paper, pull the jammed paper out slowly and carefully. Follow the instructions in the following sections to clear the jam.

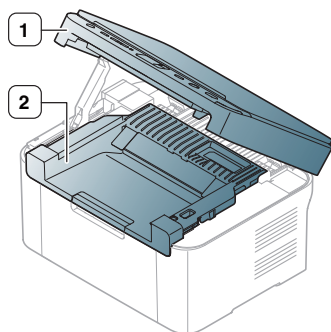

- 1 Scan unit
- 2 Inner cover

In the tray

-  Click this link to open an animation about clearing a jam.

1. Open the scan unit first, and then the inner cover.

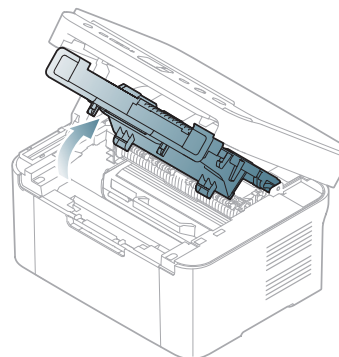
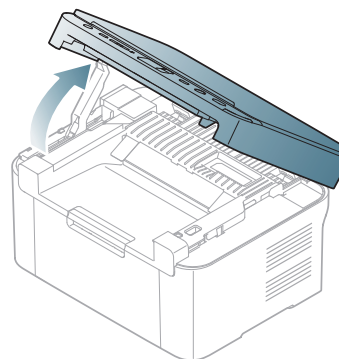

2. Close the inner cover. The jammed paper is automatically ejected from the machine.

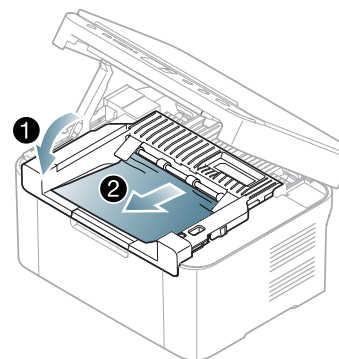

If the paper does not eject, go to the next step.

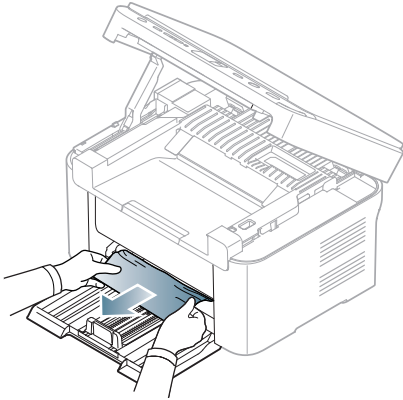

3. Remove the jammed paper by gently pulling it straight out.



If the paper does not move when you pull, or if you do not see the paper in this area, check inside the machine (See "Inside the machine" on page 79).

4. Close the inner cover and the scan unit in order. Printing automatically resumes.

Inside the machine

-  Click this link to open an animation about clearing a jam.
-  The fuser area is hot. Be careful when removing paper from this area to prevent getting your fingers burnt.

1. Open the scan unit first, and then the inner cover.

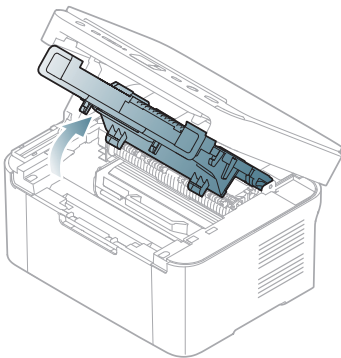
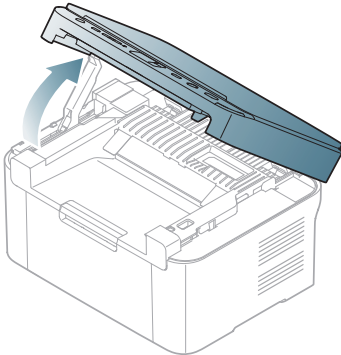

2. Close the inner cover. The jammed paper is automatically ejected from the machine.

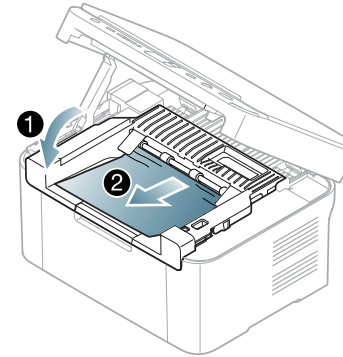

If the paper does not eject, go to the next step.

3. Open the inner cover.

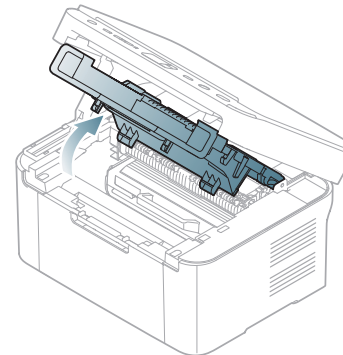

4. Open the fuser unit cover.

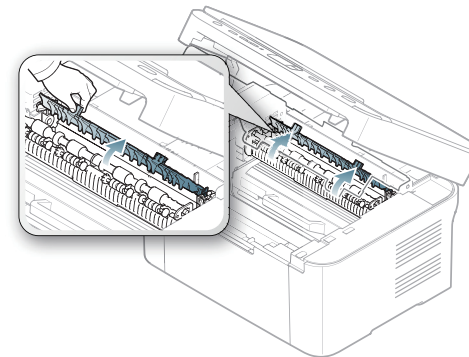

5. Remove the jammed paper by gently pulling it straight out.

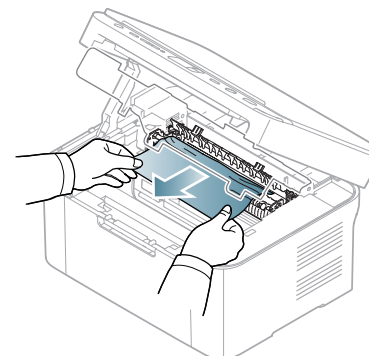

If you do not see the jammed paper, go to the next step.

6. Pull the toner cartridge out.

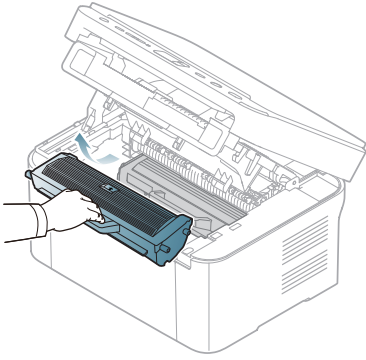

7. Remove the jammed paper by gently pulling it straight out.

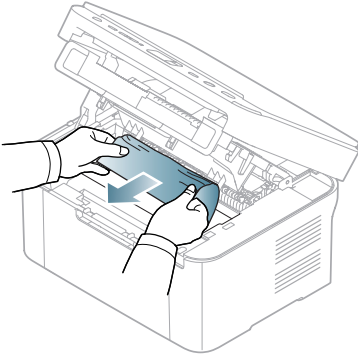

8. Insert the toner cartridge back into the machine.

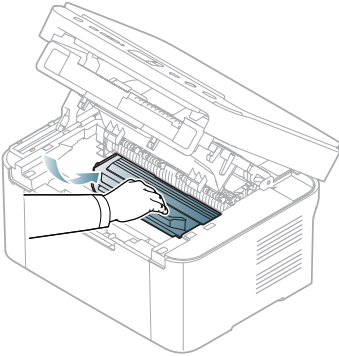

9. Close the inner cover and the scan unit in order. Printing automatically resumes.

SOLVING OTHER PROBLEMS

The following chart lists some trouble conditions that may occur and the recommended solutions. Follow the suggested solutions until the problem is corrected. If the problem persists, contact a service representative.

Other problems include:

- See "Power problems" on page 81.
- See "Paper feeding problems" on page 81.
- See "Printing problems" on page 82.
- See "Printing quality problems" on page 83.
- See "Copying problems" on page 85.
- See "Scanning problems" on page 86.
- See "Samsung Scan and Fax Manager Problem" on page 86.
- See "Common Windows problems" on page 87.
- See "Common Linux problems" on page 87.
- See "Common Macintosh problems" on page 88.

Power problems

 Click this link to open an animation about solving power problems.

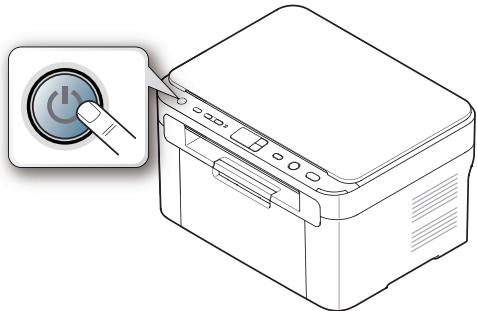
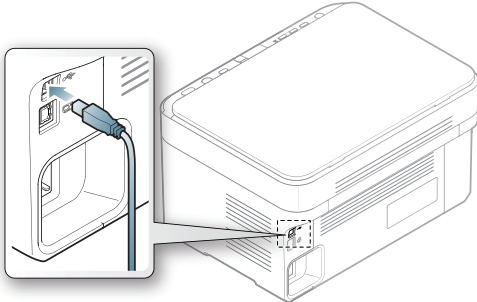
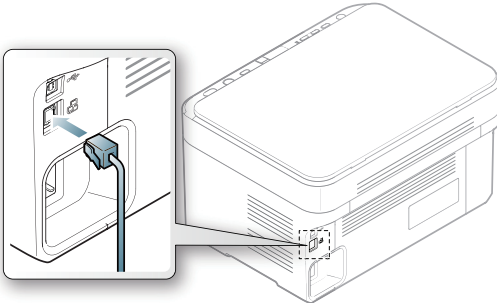
CONDITION	SUGGESTED SOLUTIONS
<p>The machine is not receiving power, or the connection cable between the computer and the machine is not connected properly.</p>	<ul style="list-style-type: none"> Plug in the power cord and press  Power button on the control panel. 
	<ul style="list-style-type: none"> Disconnect the machine cable and reconnect it. <ul style="list-style-type: none"> - For Local Printing 
	<ul style="list-style-type: none"> - For Network Printing (SCX-3205W(K) only) 

Paper feeding problems

CONDITION	SUGGESTED SOLUTIONS
Paper jams during printing.	Clear the paper jam (See "Clearing paper jams" on page 78).
Paper sticks together.	<ul style="list-style-type: none"> Check the maximum paper capacity of the tray (See "Print media specifications" on page 93). Make sure that you are using the correct type of paper (See "Print media specifications" on page 93). Remove paper from the tray and flex or fan the paper. Humid conditions may cause some paper to stick together, replace with a new stack.
Multiple sheets of paper do not feed.	Different types of paper may be stacked in the tray. Load paper of only one type, size, and weight.
Paper does not feed into the machine.	<ul style="list-style-type: none"> Remove any obstructions from inside the machine. Paper has not been loaded correctly. Remove paper from the tray and reload it correctly. There is too much paper in the tray. Remove excess paper from the tray. The paper is too thick. Use only paper that meets the specifications required by the machine (See "Print media specifications" on page 93).
The paper keeps jamming.	<ul style="list-style-type: none"> There is too much paper in the tray. Remove excess paper from the tray. If you are printing on special materials, use the manual feeder. An incorrect type of paper is being used. Use only paper that meets the specifications required by the machine (See "Print media specifications" on page 93). There may be debris inside the machine. Clean the machine inside (See Cleaning the inside).
Transparencies stick together in the paper exit.	Use only transparencies specifically designed for laser printers. Remove each transparency as it exits from the machine.
Envelopes skew or fail to feed correctly.	Ensure that the paper guides are against both sides of the envelopes.

Printing problems

CONDITION	POSSIBLE CAUSE	SUGGESTED SOLUTIONS
The machine does not print.	The machine is not receiving power.	Check the power cord connections.
	The machine is not selected as the default machine.	Select your machine as your default machine in your Windows.
	Check the machine for the followings: <ul style="list-style-type: none"> The scan unit is not closed. Close the scan unit. Paper is jammed. Clear the paper jam (See "Clearing paper jams" on page 78). No paper is loaded. Load paper (See "Loading paper in the tray" on page 50). The toner cartridge is not installed. Install the toner cartridge. If a system error occurs, contact a service representative.	
	The connection cable between the computer and the machine is not connected properly.	Disconnect the machine cable and reconnect it.
	The connection cable between the computer and the machine is defective.	If possible, attach the cable to another computer that is working properly and print a job. You can also try using a different machine cable.
	The port setting is incorrect.	Check the Windows printer settings to make sure that the print job is sent to the correct port. If the computer has more than one port, make sure that the machine is attached to the correct one.
	The machine may be configured incorrectly.	Check the Printing Preferences to ensure that all of the print settings are correct (See "Opening printing preferences" on page 55).
	The printer driver may be incorrectly installed.	Repair the machine software (See "Installing USB connected machine's driver" on page 26).
	The machine is malfunctioning.	<ul style="list-style-type: none"> Check the LEDs on the control panel to see if the machine is indicating a system error. If the error cannot be cleared, contact a service representative. Checking an error message is also possible from the Smart Panel on your computer (See "Using the Smart Panel program" on page 70).

CONDITION	POSSIBLE CAUSE	SUGGESTED SOLUTIONS
The machine does not print.	The document size is so big that the hard disk space of the computer is insufficient to access the print job.	Allocate more hard disk space on your computer for spooling, and try printing.
	The output tray is full.	It can hold up to 50 (80 g/m ²) sheets of plain paper. Once the paper is removed from the output tray, the machine resumes printing.
The machine selects print materials from the wrong paper source.	The paper option that was selected in the Printing Preferences may be incorrect.	For many software applications, the paper source selection is found under the Paper tab within the Printing Preferences . Select the correct paper source. See the printer driver help screen. (See "Opening printing preferences" on page 55).
A print job is extremely slow.	The job may be very complex.	Reduce the complexity of the page or try adjusting the print quality settings.
Half the page is blank.	The page orientation setting may be incorrect.	Change the page orientation in your application. See the printer driver help screen.
	The paper size and the paper size settings do not match.	Ensure that the paper size in the printer driver settings matches the paper in the tray. Or, ensure that the paper size in the printer driver settings matches the paper selection in the software application settings you use.
The machine prints, but the text is wrong, garbled, or incomplete.	The machine cable is loose or defective.	Disconnect the machine cable and reconnect. Try a print job that you have already printed successfully. If possible, attach the cable and the machine to another computer that you know works and try a print job. Finally, try a new machine cable.
	The wrong printer driver was selected.	Check the application's printer selection menu to ensure that your machine is selected.
	The software application is malfunctioning.	Try printing a job from another application.
	The operating system is malfunctioning.	Exit Windows and reboot the computer. Turn the machine off and back on again.

CONDITION	POSSIBLE CAUSE	SUGGESTED SOLUTIONS
The machine prints, but the text is wrong, garbled, or incomplete.	If you are in a DOS environment, the font setting for your machine may be set incorrectly.	See "Changing font setting" on page 47.
Pages print, but they are blank.	The toner cartridge is defective or out of toner.	Redistribute the toner, if necessary. If necessary, replace the toner cartridge.
	The file may have blank pages.	Check the file to ensure that it does not contain blank pages.
	Some parts, such as the controller or the board, may be defective.	Contact a service representative.
The machine does not print PDF files correctly. Some graphics, text, or illustrations are missing.	Incompatibility between the PDF file and the Acrobat products.	Printing the PDF file as an image may enable the file to print. Turn on Print As Image from the Acrobat printing options.  It will take longer to print when you print a PDF file as an image.
The print quality of photos is not good. Images are not clear.	The resolution of the photo is very low.	Reduce the photo size. If you increase the photo size in the software application, the resolution will be reduced.
Before printing, the machine emits vapor near the output tray.	Using damp paper can cause vapor during printing.	This is not a problem. Just keep printing.
The machine does not print special- sized paper, such as billing paper.	Paper size and paper size setting do not match.	Set the correct paper size in the Edit... in the Paper tab in the Printing Preferences (See "Opening printing preferences" on page 55).

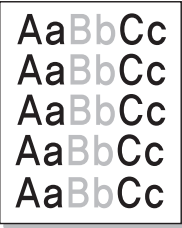
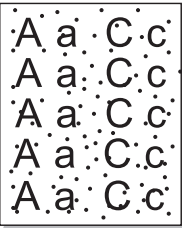
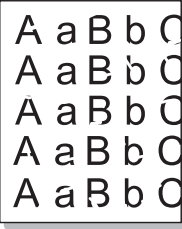

Printing quality problems

If the inside of the machine is dirty or paper has been loaded improperly, there might be a reduction in print quality. See the table below to clear the problem.

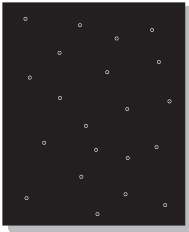
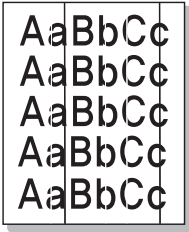
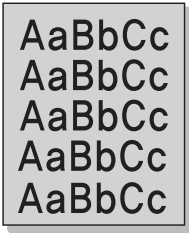
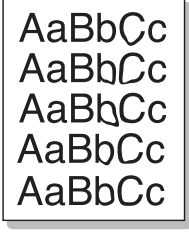
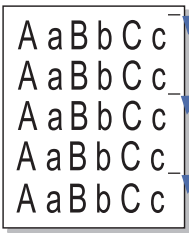
CONDITION	SUGGESTED SOLUTIONS
Light or faded print 	<ul style="list-style-type: none"> If a vertical white streak or faded area appears on the page, the toner supply is low. You may be able to temporarily extend the toner cartridge life (See "Redistributing toner" on page 77). If this does not improve the print quality, install a new toner cartridge. The paper may not meet paper specification; for example, the paper may be too moist or rough (See "Print media specifications" on page 93). If the entire page is light, the print resolution setting is too low or the toner save mode is on. Adjust the print resolution and turn the toner save mode off. See the help screen of the printer driver. A combination of faded or smeared defects may indicate that the toner cartridge needs cleaning (See "Cleaning the inside" on page 74).
Toner specks 	<ul style="list-style-type: none"> The paper may not meet specification; for example, the paper may be too moist or rough (See "Print media specifications" on page 93). The transfer roller may be dirty. Clean the inside of your machine. Contact a service representative. The paper path may need cleaning. Contact a service representative (See "Clearing paper jams" on page 78).
Dropouts 	<p>If faded areas, generally rounded, occur randomly on the page:</p> <ul style="list-style-type: none"> A single sheet of paper may be defective. Try reprinting the job. The moisture content of the paper is uneven or the paper has moist spots on its surface. Try a different brand of paper (See "Print media specifications" on page 93). The paper lot is bad. The manufacturing processes can cause some areas to reject toner. Try a different kind or brand of paper. Change the printer option and try again. Go to Printing Preferences, click Paper tab, and set type to Thick (See "Opening printing preferences" on page 55). If these steps do not correct the problem, contact a service representative.

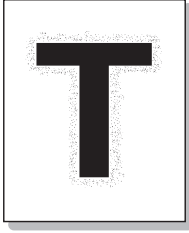
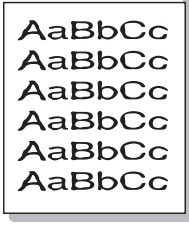
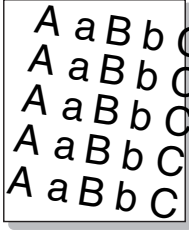
CONDITION	SUGGESTED SOLUTIONS
White Spots 	<p>If white spots appear on the page:</p> <ul style="list-style-type: none"> The paper is too rough and a lot of dirt from a paper falls to the inner devices within the machine, so the transfer roller may be dirty. Clean the inside of your machine (See "Cleaning the inside" on page 74). The paper path may need cleaning (See "Cleaning the inside" on page 74).
Vertical lines 	<p>If black vertical streaks appear on the page:</p> <ul style="list-style-type: none"> The surface (drum part) of the toner cartridge inside the machine has probably been scratched. Remove the toner cartridge and install a new one (See "Replacing the toner cartridge" on page 89). <p>If white vertical streaks appear on the page:</p> <ul style="list-style-type: none"> The surface of the LSU part inside the machine may be dirty (See "Cleaning the inside" on page 74).
Black background 	<p>If the amount of background shading becomes unacceptable:</p> <ul style="list-style-type: none"> Change to a lighter weight paper (See "Print media specifications" on page 93). Check the environmental conditions: very dry conditions or a high level of humidity (higher than 80% RH) can increase the amount of background shading. Remove the old toner cartridge and, install a new one (See "Replacing the toner cartridge" on page 89).
Toner smear 	<p>If toner smears on the page:</p> <ul style="list-style-type: none"> Clean the inside of the machine (See "Cleaning the inside" on page 74). Check the paper type and quality (See "Print media specifications" on page 93). Remove the toner cartridge and then, install a new one (See "Replacing the toner cartridge" on page 89).
Vertical repetitive defects 	<p>If marks repeatedly appear on the printed side of the page at even intervals:</p> <ul style="list-style-type: none"> The toner cartridge may be damaged. If you still have the same problem, remove the toner cartridge and, install a new one (See "Replacing the toner cartridge" on page 89). Parts of the machine may have toner on them. If the defects occur on the back of the page, the problem will likely correct itself after a few more pages. The fusing assembly may be damaged. Contact a service representative.

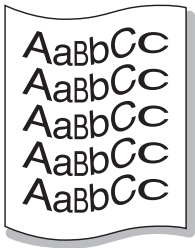
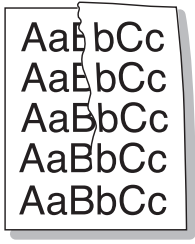
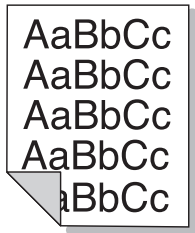
CONDITION	SUGGESTED SOLUTIONS
Background scatter 	<p>Background scatter results from bits of toner randomly distributed on the printed page.</p> <ul style="list-style-type: none"> The paper may be too damp. Try printing with a fresh ream of paper. Do not open packages of paper until necessary so that the paper does not absorb too much moisture. If background scatter occurs on an envelope, change the printing layout to avoid printing over areas that have overlapping seams on the reverse side. Printing on seams can cause problems. If background scatter covers the entire surface area of a printed page, adjust the print quality through your software application or in Printing Preferences (See "Opening printing preferences" on page 55).
Toner particles are around bold characters or pictures 	<p>The toner might not adhere properly to this type of paper.</p> <ul style="list-style-type: none"> Change the printer option and try again. Go to the Printing Preferences, click the Paper tab, and set the paper type to Recycled.
Misformed characters 	<ul style="list-style-type: none"> If characters are improperly formed and producing hollow images, the paper stock may be too slick. Try different paper (See "Print media specifications" on page 93).
Page skew 	<ul style="list-style-type: none"> Ensure that the paper is loaded properly. Check the paper type and quality (See "Print media specifications" on page 93). Ensure that the guides are not too tight or too loose against the paper stack.

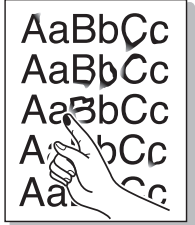
CONDITION	SUGGESTED SOLUTIONS
<p>Curl or wave</p> 	<ul style="list-style-type: none"> • Ensure that the paper is loaded properly. • Check the paper type and quality. Both high temperature and humidity can cause paper curl (See "Print media specifications" on page 93). • Turn the stack of paper over in the tray. Also try rotating the paper 180° in the tray.
<p>Wrinkles or creases</p> 	<ul style="list-style-type: none"> • Ensure that the paper is loaded properly. • Check the paper type and quality (See "Print media specifications" on page 93). • Turn the stack of paper over in the tray. Also try rotating the paper 180° in the tray.
<p>Back of printouts are dirty</p> 	<p>Check for leaking toner. Clean the inside of the machine (See "Cleaning the inside" on page 74).</p>
<p>Solid Color or Black pages</p> 	<ul style="list-style-type: none"> • The toner cartridge may not be installed properly. Remove the cartridge and reinsert it. • The toner cartridge may be defective. Remove the toner cartridge and install a new one (See "Replacing the toner cartridge" on page 89). • The machine may require repair. Contact a service representative.
<p>Loose toner</p> 	<ul style="list-style-type: none"> • Clean the inside of the machine (See "Cleaning the inside" on page 74). • Check the paper type and quality (See "Print media specifications" on page 93). • Remove the toner cartridge and then, install a new one (See "Replacing the toner cartridge" on page 89). • If the problem persists, the machine may require repair. Contact a service representative.

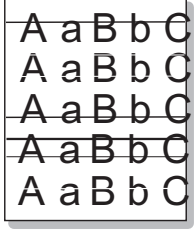
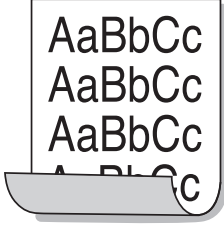
CONDITION	SUGGESTED SOLUTIONS
<p>Character Voids</p> 	<p>Character voids are white areas within parts of characters that should be solid black:</p> <ul style="list-style-type: none"> • If you are using transparencies, try another type of transparency. Because of the composition of transparencies, some character voids are normal. • You may be printing on the wrong surface of the paper. Remove the paper and turn it over. • The paper may not meet paper specifications (See "Print media specifications" on page 93).
<p>Horizontal stripes</p> 	<p>If horizontally aligned black streaks or smears appear:</p> <ul style="list-style-type: none"> • The toner cartridge may be installed improperly. Remove the cartridge and reinsert it. • The toner cartridge may be defective. Remove the toner cartridge and install a new one (See "Replacing the toner cartridge" on page 89). • If the problem persists, the machine may require repair. Contact a service representative.
<p>Curl</p> 	<p>If the printed paper is curled or paper does not feed into the machine:</p> <ul style="list-style-type: none"> • Turn the stack of paper over in the tray. Also try rotating the paper 180° in the tray. • Change the printer option and try again. Go to Printing Preferences, click Paper tab, and set type to Thin (See "Opening printing preferences" on page 55).
<p>An unknown image repeatedly appears on a few sheets or loose toner, light print, or contamination occurs.</p>	<p>Your machine is probably being used at an altitude of 1,000 m (3,281 ft.) or above. The high altitude may affect the print quality such as loose toner or light imaging. You can select a correct altitude of your machine location (See "Altitude adjustment" on page 46).</p>

Copying problems

CONDITION	SUGGESTED SOLUTION
<p>Copies are too light or too dark.</p>	<p>Adjust darkness to lighten or darken the backgrounds of copies using Printer Settings Utility (See "Changing the settings for each copy" on page 62).</p>

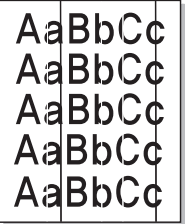
CONDITION	SUGGESTED SOLUTION
<p>Smears, lines, marks, or spots appear on copies.</p> 	<ul style="list-style-type: none"> If the defects are on the original, adjust darkness to lighten the background of your copies using Printer Settings Utility (See "Changing the settings for each copy" on page 62). If there are no defects on the original, clean the scan unit (See "Cleaning the scan unit" on page 75).
<p>Copy image is skewed.</p>	<ul style="list-style-type: none"> Ensure that the original is face down on the scanner glass. Check that the copy paper is loaded correctly.
<p>Blank copies print out.</p>	<p>Ensure that the original is face down on the scanner glass.</p>
<p>Image rubs off the copy easily.</p>	<ul style="list-style-type: none"> Replace the paper in the tray with paper from a new package. In high humidity areas, do not leave paper in the machine for extended periods of time.
<p>Frequent copy paper jams occur.</p>	<ul style="list-style-type: none"> Fan the stack of paper, then turn it over in the tray. Replace the paper in the tray with a fresh supply. Check/adjust the paper guides, if necessary. Ensure that the paper is the proper paper weight. Check for copy paper or pieces of copy paper remaining in the machine after a paper jam has been cleared.
<p>Toner cartridge produces fewer copies than expected before running out of toner.</p>	<ul style="list-style-type: none"> Your originals may contain pictures, solids, or heavy lines. For example, your originals may be forms, newsletters, books, or other documents that use more toner. The scanner lid may be left open while copies are being made. Turn the machine off and back on.

Scanning problems

CONDITION	SUGGESTED SOLUTIONS
<p>The scanner does not work.</p>	<ul style="list-style-type: none"> Make sure that you place the original to be scanned face down on the scanner glass. There may not be enough available memory to hold the document you want to scan. Try the Prescan function to see if that works. Try lowering the scan resolution rate. Check that the machine cable is connected properly. Make sure that the machine cable is not defective. Switch the cable with a known good cable. If necessary, replace the cable. Check that the scanner is configured correctly. Check scan setting in the SmarThru or the application you want to use to make certain that the scanner job is being sent to the correct port (for example, USB001).
<p>The unit scans very slowly.</p>	<ul style="list-style-type: none"> Check if the machine is printing received data. If so, scan the document after the received data has been printed. Graphics are scanned more slowly than text.
<p>Message appears on your computer screen:</p> <ul style="list-style-type: none"> Device can't be set to the H/W mode you want. Port is being used by another program. Port is Disabled. Scanner is busy receiving or printing data. When the current job is completed, try again. Invalid handle. Scanning has failed. 	<ul style="list-style-type: none"> There may be a copying or printing job in progress. Try your job again when that job is finished. The selected port is currently being used. Restart your computer and try again. The machine cable may be improperly connected or the power may be off. The scanner driver is not installed or the operating environment is not set up properly. Ensure that the machine is properly connected and the power is on, then restart your computer. The USB cable may be improperly connected or the power may be off.

Samsung Scan and Fax Manager Problem

CONDITION	SUGGESTED SOLUTION
<p>Samsung Scan and Fax Manager does not work.</p>	<p>Check your system requirements. Samsung Scan and Fax Manager works in Windows and Mac OS (See "System requirements" on page 25).</p>

Common Windows problems

CONDITION	SUGGESTED SOLUTIONS
“File in Use” message appears during installation.	Exit all software applications. Remove all software from the startup group, then restart Windows. Reinstall the printer driver.
“General Protection Fault”, “Exception OE”, “Spool 32”, or “Illegal Operation” messages appear.	Close all other applications, reboot Windows and try printing again.
“Fail To Print”, “A printer timeout error occurred” messages appear.	These messages may appear during printing. Just keep waiting until the machine finishes printing. If the message appears in ready mode or after printing has been completed, check the connection and/or whether an error has occurred.

 Refer to the Microsoft Windows User’s Guide that came with your computer for further information on Windows error messages.

Common Linux problems

CONDITION	SUGGESTED SOLUTIONS
The machine does not print.	<ul style="list-style-type: none"> • Check if the printer driver is installed in your system. Open Unified Driver Configurator and switch to the Printers tab in Printers configuration window to look at the list of available machines. Make sure that your machine is displayed on the list. If not, open Add new printer wizard to set up your device. • Check if the machine is started. Open Printers configuration and select your machine on the printers list. Look at the description in the Selected printer pane. If its status contains Stopped string, press  Start button. After that normal operation of the machine should be restored. The “stopped” status might be activated when some problems in printing occurred. For instance, this could be an attempt to print a document when the port is claimed by a scanning application. • Ensure the port is not busy. Since functional components of machine (printer and scanner) share the same I/O interface (port), the situation of simultaneous access of different user applications to the same port is possible. To avoid possible conflicts, only one of them at a time is allowed to gain control over the device. The other user will encounter “device busy” response. You should open ports configuration and select the port assigned to your machine. In the Selected port pane you can see if the port is occupied by some other application. If this is the case, you should either wait for completion of the current job or press the Release port button, if you are sure that the present application is not functioning properly. • Check if your application has special print option such as “-oraw”. If “-oraw” is specified in the command line parameter, then remove it to print properly. For Gimp front-end, select “print” -> “Setup printer” and edit command line parameter in the command item. • The CUPS (Common Unix Printing System) version distributed with SuSE Linux 9.2 (cups-1.1.21) has a problem with ipp (Internet Printing Protocol) printing. Use the socket printing instead of ipp or install a later version of CUPS (cups-1.1.22 or higher).
The machine does not print whole pages, and output is printed on half the page.	It is a known problem that occurs when a color machine is used on version 8.51 or earlier of Ghostscript, 64-bit Linux OS, and has been reported to bugs.ghostscript.com as Ghostscript Bug 688252. The problem is solved in AFPL Ghostscript v. 8.52 or above. Download the latest version of AFPL Ghostscript from http://sourceforge.net/projects/ghostscript/ and install it to solve this problem.

CONDITION	SUGGESTED SOLUTIONS
I cannot scan via Gimp Front-end.	<p>Check if Gimp Front-end has Xsane: Device dialog on the Acquire menu. If not, you should install Xsane plug-in for Gimp on the your computer. You can find Xsane plug-in package for Gimp on Linux distribution CD or Gimp home page. For the detailed information, refer to the Help for Linux distribution CD or Gimp Front-end application.</p> <p>If you wish to use another kind of scan application, refer to application's Help.</p>
I encounter the "Cannot open port device file" error when printing a document.	<p>Avoid changing print job parameters (via LPR GUI, for example) while a print job is in progress. Known versions of CUPS server break the print job whenever print options are changed and then try to restart the job from the beginning. Since Unified Linux Driver locks the port while printing, the abrupt termination of the driver keeps the port locked and unavailable for subsequent print jobs. If this situation occurs, try to release the port by selecting Release port in Port configuration window.</p>
The machine does not appear on the scanners list.	<ul style="list-style-type: none"> • Ensure your machine is attached to your computer, connected properly via the USB port, and is turned on. • Ensure the scanner driver for your machine is installed in your system. Open Unified Linux Driver configurator, switch to Scanners configuration, then press Drivers. Make sure that driver with a name corresponding to your machine's name is listed in the window. • Ensure the port is not busy. Since functional components of machine (printer and scanner) share the same I/O interface (port), the situation of simultaneous access of different user applications to the same port is possible. To avoid possible conflicts, only one of them at a time is allowed to gain control over the device. The other user will encounter "device busy" response. This usually happens when starting a scan procedure. An appropriate message box appears. <p>To identify the source of the problem, open the Ports configuration and select the port assigned to your scanner, port's symbol /dev/mfp0 corresponds to LP:0 designation displayed in the scanners' options, /dev/mfp1 relates to LP:1, and so on. USB ports start at /dev/mfp4, so scanner on USB:0 relates to /dev/mfp4 respectively and so forth sequentially. In the Selected port pane, you can see if the port is occupied by another application. If this is the case, you should either wait for completion of the current job or press the Release port button, if you are sure that the present port application is not functioning properly.</p>

CONDITION	SUGGESTED SOLUTIONS
The machine does not scan.	<ul style="list-style-type: none"> • Ensure a document is loaded into the machine, ensure your machine is connected to the computer. • If there is an I/O error while scanning.

 Refer to the Linux User's Guide that came with your computer for further information on Linux error messages.

Common Macintosh problems

CONDITION	SUGGESTED SOLUTIONS
The machine does not print PDF files correctly. Some parts of graphics, text, or illustrations are missing.	<p>Printing the PDF file as an image may enable the file to print. Turn on Print As Image from the Acrobat printing options.</p> <p> It will take longer to print when you print a PDF file as an image.</p>
The document has printed, but the print job has not disappeared from the spooler in Mac OS X 10.3.2.	<p>Update your Mac OS to Mac OS X 10.3.3. or higher.</p>
Some letters are not displayed normally during the Cover page printing.	<p>Mac OS cannot create the font during the Cover page printing. The English alphabet and numbers are displayed normally on the Cover page.</p>
When printing a document in Macintosh with Acrobat Reader 6.0 or higher, colors print incorrectly.	<p>Make sure that the resolution setting in your machine driver matches the one in Acrobat Reader.</p>

 Refer to the Macintosh User's Guide that came with your computer for further information on Macintosh error messages.

This chapter provides information about purchasing supplies and maintenance parts available for your machine.

This chapter includes:

- How to purchase
- Available supplies

 Available accessories may differ from country to country. Contact your sales representatives to obtain the list of available accessories.

HOW TO PURCHASE

To order Samsung-authorized supplies, accessories, and maintenance parts, contact your local Samsung dealer or the retailer where you purchased your machine. You can also visit www.samsung.com/supplies, select your country/region, and obtain information on calling for service.

AVAILABLE SUPPLIES

When supplies reach their lifespan, you can order the following types of supplies for your machine:

MODEL NUMBER
<ul style="list-style-type: none"> • 104 (MLT-D104S): Available in all regions except those listed in Region A and B. • 1042 (MLT-D1042S): Region A^a • 1043 (MLT-D1043S): Region B^b: • 104 (MLT-D104X): Not available in all regions. <p>*Refer to your local Samsung website for availability.</p>

a. Region A: Albania, Austria, Belgium, Bosnia, Bulgaria, Croatia, Cyprus, Czech Republic, Denmark, Estonia, Finland, France, Germany, Greece, Hungary, Italy, Latvia, Lithuania, Macedonia, Netherlands, Norway, Poland, Portugal, Romania, Serbia, Slovakia, Slovenia, Spain, Sweden, Switzerland, UK.

b. Region B: China, Bangladesh, India, Nepal, Ukraine, Vietnam.

To replace a toner cartridge, see "Replacing the toner cartridge" on page 89.

 Depending on the options and job mode used, the toner cartridge's lifespan may differ.

 You must purchase supplies, including toner cartridges, in the same country where you purchased your machine. Otherwise, supplies will be incompatible with your machine since the system configuration of these vary from country to country.

 Samsung does not recommend using non-genuine Samsung toner cartridge such as refilled or remanufactured. Samsung cannot guarantee non-genuine Samsung toner cartridge's quality. Service or repair required as a result of using non-genuine Samsung toner cartridges will not be covered under the machine warranty.

- Available maintenance parts
- Replacing the toner cartridge

AVAILABLE MAINTENANCE PARTS

To purchase maintenance parts, contact the source where you bought the machine.

Replacing maintenance parts can be performed only by an authorized service provider, dealer, or the retailer where you bought the machine. The warranty does not cover the replacement of any maintenance parts once it has reached its "Average Yield".

Maintenance parts are replaced at specific intervals to avoid print quality and paper feed problems resulting from worn parts, see table below. The purpose of which is to maintain your machine in top working condition. The maintenance parts below should be replaced when the life span of each item has been met.

PARTS	AVERAGE YIELD ^A
Transfer roller	Approx. 30,000 pages
Fuser unit	Approx. 30,000 pages
Pickup roller	Approx. 30,000 pages

a. Yield is affected by operating system used, computing performance, application software, connecting method, media type, media size, and job complexity.

REPLACING THE TONER CARTRIDGE

 Click this link to open an animation about replacing a toner cartridge.

When the toner cartridge reaches its estimated cartridge life,

- The Smart Panel program window appears on the computer telling you the toner cartridge needs to be replaced.
- The machine stops printing.

At this stage, the toner cartridge needs to be replaced. Check the model number for the toner cartridge used in your machine (See "Available supplies" on page 89).

1. Turn the machine off, then wait a few minutes for the machine to cool.
2. Open the scan unit.

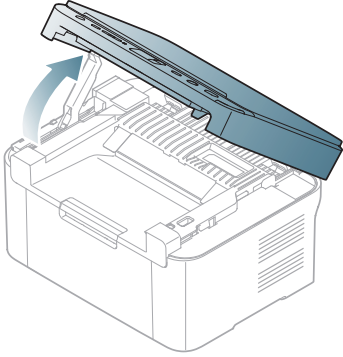

3. Open the inner cover.

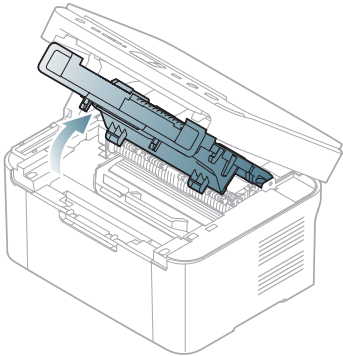

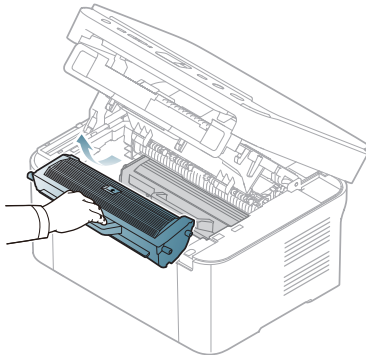

4. Pull the toner cartridge out.

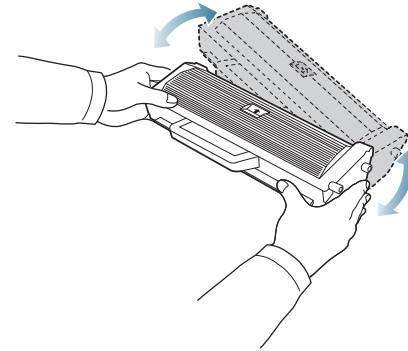

5. Take a new toner cartridge out of its package.

6. Slowly shake the cartridge side to side five or six times to distribute the toner evenly inside the cartridge. It will assure maximum copies per cartridge.



 If toner gets on your clothing, wipe it off with a dry cloth and wash clothing in cold water. Hot water sets toner into fabric.

 Do not touch the drum located in the toner cartridge or imaging unit. Use the handle on the cartridge to avoid touching this area.

7. Remove the cap protecting the toner cartridge.

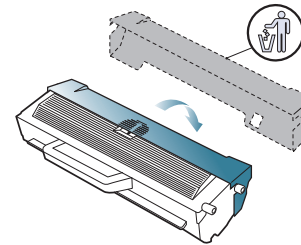

8. Hold the toner cartridge by the handle and slowly insert the cartridge into the opening in the machine.

Tabs on the sides of the cartridge and corresponding grooves within the machine will guide the cartridge into the correct position until it locks into place completely.

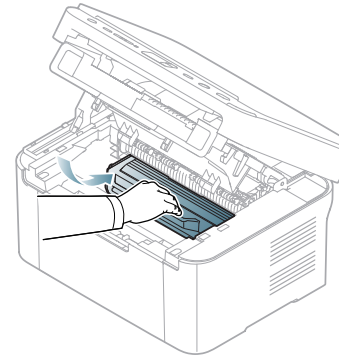

9. Close the inner cover and the scan unit completely in order.
10. Turn the machine on.

specifications

This chapter covers the machines primary specifications.

This chapter includes:

- Hardware specifications
- Environmental specifications
- Electrical specifications
- Print media specifications

 The specification values are listed below: specifications are subject to change without notice: See www.samsung.com/printer for possible changes in information.

HARDWARE SPECIFICATIONS

ITEM		DESCRIPTION
Dimension	Height	234 mm (9.21 inches)
	Depth	299 mm (11.77 inches)
	Width	388 mm (15.28 inches)
Weight	Machine with consumables	7.5 kg (16.53 lbs)
Package weight	Paper	1.22 kg (2.69 lbs)
	Plastic	0.24 kg (0.52 lbs)

ENVIRONMENTAL SPECIFICATIONS

ITEM		DESCRIPTION
Noise Level ^a	Ready mode	26 dB(A)
	Printing mode	49 dB(A)
	Copying mode	49 dB(A)
Temperature	Operation	10 to 32 °C (50 to 90 °F)
	Storage (unpacked)	0 to 40 °C (32 to 104 °F)
Humidity	Operation	10 to 80% RH
	Storage (unpacked)	20 to 80% RH

a. Sound Pressure Level, ISO 7779. Configuration tested: machine basic installation, A4 paper, simplex printing.

ELECTRICAL SPECIFICATIONS

 Power requirements are based on the country/region where the device is sold. Do not convert operating voltages. Doing so might damage the device and void the product warranty.

	ITEM	DESCRIPTION
Power rating^a	110 volt models	AC 110 - 127 V
	220 volt models	AC 220 - 240 V
Power consumption	Average operating mode	Less than 270W
	Ready mode	Less than 36W
	Power save mode	<ul style="list-style-type: none"> • SCX-3200 Series: 3.8W • SCX-3205W(K): 5.6 W
	Power off mode	Less than 0.45 W

a. See the rating label on the machine for the correct voltage (V), frequency (hertz) and type of current (A) for your machine.

PRINT MEDIA SPECIFICATIONS

TYPE	SIZE	DIMENSIONS	PRINT MEDIA WEIGHT ^A /CAPACITY ^B	
			TRAY	MANUAL FEEDING IN THE TRAY
Plain paper	Letter	216 x 279 mm (8.50 x 11.00 inches)	60 to 120 g/m ² (16 to 32 lbs bond) • 150 sheets of 80 g/m ² (20 lbs bond)	60 to 163 g/m ² (16 to 43 lbs bond) • 1 sheet for manual feeding in the tray
	Legal	216 x 356 mm (8.50 x 14.00 inches)		
	US Folio	216 x 330 mm (8.50 x 13.00 inches)		
	A4	210 x 297 mm (8.27 x 11.69 inches)		
	Oficio	216 x 343 mm (8.50 x 13.50 inches)		
	JIS B5	182 x 257 mm (7.17 x 10.12 inches)		
	ISO B5	176 x 250 mm (6.93 x 9.84 inches)		
	Executive	184 x 267 mm (7.25 x 10.51 inches)		
	A5	148 x 210 mm (5.83 x 8.27 inches)		
Envelope	Envelope Monarch	98 x 191 mm (3.87 x 7.50 inches)	75 to 90 g/m ² (20 to 24 lbs bond) • 1 sheet for manual feeding in the tray	
	Envelope No. 10	105 x 241 mm (4.12 x 9.50 inches)		
	Envelope DL	110 x 220 mm (4.33 x 8.66 inches)		
	Envelope C5	162 x 229 mm (6.38 x 9.02 inches)		
Thick paper	Refer to the Plain paper section	Refer to the Plain paper section	90 g/m ² (24 lbs bond) • 140 sheets	90 to 163 g/m ² (24 to 43 lbs bond) • 1 sheet for manual feeding in the tray
Thin paper	Refer to the Plain paper section	Refer to the Plain paper section	60 to 70 g/m ² (16 to 19 lbs bond) • 1 sheet for manual feeding in the tray	
Transparency	Letter, A4	Refer to the Plain paper section	138 to 146 g/m ² (37 to 39 lbs bond) • 1 sheet for manual feeding in the tray	
Labels^c	Letter, Legal, US Folio, A4, JIS B5, ISO B5, Executive, A5	Refer to the Plain paper section	120 to 150 g/m ² (32 to 40 lbs bond) • 1 sheet for manual feeding in the tray	
Card stock	Letter, Legal, US Folio, A4, JIS B5, ISO B5, Executive, A5	Refer to the Plain paper section	105 to 163 g/m ² (28 to 43 lbs bond) • 1 sheet for manual feeding in the tray	
Minimum size (custom)		76 x 196 mm (3.00 x 7.70 inches)	60 to 163 g/m ² (16 to 43 lbs bond)	
Maximum size (custom)		216 x 356 mm (8.50 x 14.02 inches)		

a. If media weight is over 120 g/m² (32 lbs), load a paper into the tray one by one.

b. Maximum capacity may differ depending on media weight, thickness and environmental conditions.

c. Smoothness: 100 to 250 (sheffield).

contact samsung worldwide

If you have any comments or questions regarding Samsung products, contact the Samsung customer care center.

COUNTRY/REGION	CUSTOMER CARE CENTER	WEB SITE
ARGENTINE	0800-333-3733	www.samsung.com
ARMENIA	0-800-05-555	
AUSTRALIA	1300 362 603	www.samsung.com
AUSTRIA	0810-SAMSUNG (7267864, € 0.07/min)	www.samsung.com
AZERBAIJAN	088-55-55-555	
BAHRAIN	8000-4726	
BELARUS	810-800-500-55-500	www.samsung.ua www.samsung.com/ua_ru
BELGIUM	02-201-24-18	www.samsung.com/be (Dutch) www.samsung.com/be_fr (French)
BRAZIL	0800-124-421 4004-0000	www.samsung.com
CANADA	1-800-SAMSUNG (726-7864)	www.samsung.com
CHILE	800-SAMSUNG (726-7864)	www.samsung.com
CHINA	400-810-5858 010-6475 1880	www.samsung.com
COLOMBIA	01-8000112112	www.samsung.com
COSTA RICA	0-800-507-7267	www.samsung.com
CZECH REPUBLIC	800-SAMSUNG (800-726786) Samsung Zrt., česká organizační složka, Oasis Florenc, Sokolovská394/17, 180 00, Praha 8	www.samsung.com
DENMARK	70 70 19 70	www.samsung.com
ECUADOR	1-800-10-7267	www.samsung.com
EGYPT	0800-726786	
EIRE	0818 717100	www.samsung.com
EL SALVADOR	800-6225	www.samsung.com
ESTONIA	800-7267	www.samsung.com
KAZAKHSTAN	8-10-800-500-55-500	www.samsung.com/kz_ru
KYRGYZSTAN	00-800-500-55-500	
FINLAND	030-6227 515	www.samsung.com
FRANCE	01 48 63 00 00	www.samsung.com

COUNTRY/REGION	CUSTOMER CARE CENTER	WEB SITE
GERMANY	01805 - SAMSUNG (726-7864 € 0,14/min)	www.samsung.com
GEORGIA	8-800-555-555	
GUATEMALA	1-800-299-0013	www.samsung.com
HONDURAS	800-7919267	www.samsung.com
HONG KONG	(852) 3698-4698	www.samsung.com/hk www.samsung.com/hk_en/
HUNGARY	06-80-SAMSUNG (726-7864)	www.samsung.com
INDIA	3030 8282 1800 110011 1800 3000 8282 1800 266 8282	www.samsung.com
INDONESIA	0800-112-8888 021-5699-7777	www.samsung.com
ITALIA	800-SAMSUNG (726-7864)	www.samsung.com
JAMAICA	1-800-234-7267	www.samsung.com
JAPAN	0120-327-527	www.samsung.com
JORDAN	800-22273	
KSA	9200-21230	www.samsung.com
BAHRAIN	8000-4726	
LATVIA	8000-7267	www.samsung.com
LITHUANIA	8-800-77777	www.samsung.com
LUXEMBURG	261 03 710	www.samsung.com
MALAYSIA	1800-88-9999	www.samsung.com
MEXICO	01-800-SAMSUNG (726-7864)	www.samsung.com
MOLDOVA	00-800-500-55-500	www.samsung.ua www.samsung.com/ua_ru
NETHERLANDS	0900-SAMSUNG (0900-7267864) (€ 0,10/min)	www.samsung.com
NEW ZEALAND	0800 SAMSUNG (0800 726 786)	www.samsung.com
NICARAGUA	00-1800-5077267	www.samsung.com
NORWAY	815-56 480	www.samsung.com
PANAMA	800-7267	www.samsung.com

COUNTRY/REGION	CUSTOMER CARE CENTER	WEB SITE
PHILIPPINES	1800-10-SAMSUNG (726-7864) 1-800-3-SAMSUNG (726-7864) 1-800-8-SAMSUNG (726-7864) 02-5805777	www.samsung.com
POLAND	0 801 1SAMSUNG (172678) 022-607-93-33	www.samsung.com
PORTUGAL	80820-SAMSUNG (726-7864)	www.samsung.com
PUERTO RICO	1-800-682-3180	www.samsung.com
QATAR	800-2255	
REP. DOMINICA	1-800-751-2676	www.samsung.com
RUSSIA	8-800-555-55-55	www.samsung.ru
SINGAPORE	1800-SAMSUNG (726-7864)	www.samsung.com
SLOVAKIA	0800-SAMSUNG (726-7864)	www.samsung.com
SOUTH AFRICA	0860 SAMSUNG (726-7864)	www.samsung.com
SPAIN	902-1-SAMSUNG(902 172 678)	www.samsung.com
SWEDEN	0771 726 7864 (SAMSUNG)	www.samsung.com
SWITZERLAND	0848-SAMSUNG (7267864, CHF 0.08/min)	www.samsung.com
SYRIA	1825-22-73	
TADJIKISTAN	8-10-800-500-55-500	
TAIWAN	0800-329-999	www.samsung.com
THAILAND	1800-29-3232 02-689-3232	www.samsung.com
TRINIDAD & TOBAGO	1-800-SAMSUNG (726-7864)	www.samsung.com
TURKEY	444 77 11	www.samsung.com
U.A.E	800-SAMSUNG (726-7864)	www.samsung.com
U.K	0845 SAMSUNG (726-7864)	www.samsung.com
U.S.A	1-800-SAMSUNG (726-7864)	www.samsung.com
UKRAINE	8-800-502-000	www.samsung.ua www.samsung.com/ua_ru

COUNTRY/REGION	CUSTOMER CARE CENTER	WEB SITE
UZBEKISTAN	8-10-800-500-55-500	www.samsung.com/kz_ru
VENEZUELA	0-800-100-5303	www.samsung.com
VIETNAM	1 800 588 889	www.samsung.com

glossary

 The following glossary helps you get familiar with the product by understanding the terminologies commonly used with printing as well as mentioned in this user's guide.

802.11

802.11 is a set of standards for wireless local area network (WLAN) communication, developed by the IEEE LAN/MAN Standards Committee (IEEE 802).

802.11b/g

802.11b/g can share same hardware and use the 2.4 GHz band. 802.11b supports bandwidth up to 11 Mbps; 802.11g up to 54 Mbps. 802.11b/g devices may occasionally suffer interference from microwave ovens, cordless telephones, and Bluetooth devices.

Access point

Access Point or Wireless Access Point (AP or WAP) is a device that connects wireless communication devices together on wireless local area networks (WLAN), and acts as a central transmitter and receiver of WLAN radio signals.

ADF

An Automatic Document Feeder (ADF) is a scanning unit that will automatically feed an original sheet of paper so that the machine can scan some amount of the paper at once.

AppleTalk

AppleTalk is a proprietary suite of protocols developed by Apple, Inc for computer networking. It was included in the original Macintosh (1984) and is now deprecated by Apple in favor of TCP/IP networking.

BIT Depth

A computer graphics term describing the number of bits used to represent the color of a single pixel in a bitmapped image. Higher color depth gives a broader range of distinct colors. As the number of bits increases, the number of possible colors becomes impractically large for a color map. 1-bit color is commonly called as monochrome or black and white.

BMP

A bitmapped graphics format used internally by the Microsoft Windows graphics subsystem (GDI), and used commonly as a simple graphics file format on that platform.

BOOTP

Bootstrap Protocol. A network protocol used by a network client to obtain its IP address automatically. This is usually done in the bootstrap process of computers or operating systems running on them. The BOOTP servers assign the IP address from a pool of addresses to each client. BOOTP enables 'diskless workstation' computers to obtain an IP address prior to loading any advanced operating system.

CCD

Charge Coupled Device (CCD) is a hardware which enables the scan job. CCD Locking mechanism is also used to hold the CCD module to prevent any damage when you move the machine.

Collation

Collation is a process of printing a multiple-copy job in sets. When collation is selected, the device prints an entire set before printing additional copies.

Control Panel

A control panel is a flat, typically vertical, area where control or monitoring instruments are displayed. They are typically found in front of the machine.

Coverage

It is the printing term used for a toner usage measurement on printing. For example, 5% coverage means that an A4 sided paper has about 5% image or text on it. So, if the paper or original has complicated images or lots of text on it, the coverage will be higher and at the same time, a toner usage will be as much as the coverage.

CSV

Comma Separated Values (CSV). A type of file format, CSV is used to exchange data between disparate applications. The file format, as it is used in Microsoft Excel, has become a de facto standard throughout the industry, even among non-Microsoft platforms.

DADF

A Duplex Automatic Document Feeder (DADF) is a scanning unit that will automatically feed and turn over an original sheet of paper so that the machine can scan on both sides of the paper.

Default

The value or setting that is in effect when taking a printer out of its box state, reset, or initialized.

DHCP

A Dynamic Host Configuration Protocol (DHCP) is a client-server networking protocol. A DHCP server provides configuration parameters specific to the DHCP client host requesting, generally, information required by the client host to participate on an IP network. DHCP also provides a mechanism for allocation of IP addresses to client hosts.

DIMM

Dual Inline Memory Module (DIMM), a small circuit board that holds memory. DIMM stores all the data within the machine like printing data, received fax data.

DNS

The Domain Name Server (DNS) is a system that stores information associated with domain names in a distributed database on networks, such as the Internet.

Dot Matrix Printer

A dot matrix printer refers to a type of computer printer with a print head that runs back and forth on the page and prints by impact, striking an ink-soaked cloth ribbon against the paper, much like a typewriter.

DPI

Dots Per Inch (DPI) is a measurement of resolution that is used for scanning and printing. Generally, higher DPI results in a higher resolution, more visible detail in the image, and a larger file size.

DRPD

Distinctive Ring Pattern Detection. Distinctive Ring is a telephone company service which enables a user to use a single telephone line to answer several different telephone numbers.

Duplex

A mechanism that will automatically turn over a sheet of paper so that the machine can print (or scan) on both sides of the paper. A printer equipped with a Duplex Unit can print on both sides of paper during one print cycle.

Duty Cycle

Duty cycle is the page quantity which does not affect printer performance for a month. Generally the printer has the lifespan limitation such as pages per year. The lifespan means the average capacity of print-outs, usually within the warranty period. For example, if the duty cycle is 48,000 pages per month assuming 20 working days, a printer limits 2,400 pages a day.

ECM

Error Correction Mode (ECM) is an optional transmission mode built into Class 1 fax machines or fax modems. It automatically detects and corrects errors in the fax transmission process that are sometimes caused by telephone line noise.

Emulation

Emulation is a technique of one machine obtaining the same results as another.

An emulator duplicates the functions of one system with a different system, so that the second system behaves like the first system. Emulation focuses on exact reproduction of external behavior, which is in contrast to simulation, which concerns an abstract model of the system being simulated, often considering its internal state.

Ethernet

Ethernet is a frame-based computer networking technology for local area networks (LANs). It defines wiring and signaling for the physical layer, and frame formats and protocols for the media access control (MAC)/data link layer of the OSI model. Ethernet is mostly standardized as IEEE 802.3. It has become the most widespread LAN technology in use during the 1990s to the present.

EtherTalk

A suite of protocols developed by Apple Computer for computer networking. It was included in the original Macintosh (1984) and is now deprecated by Apple in favor of TCP/IP networking.

FDI

Foreign Device Interface (FDI) is a card installed inside the machine to allow a third party device such as a coin operated device or a card reader. Those devices allow the pay-for-print service on your machine.

FTP

A File Transfer Protocol (FTP) is a commonly used protocol for exchanging files over any network that supports the TCP/IP protocol (such as the Internet or an intranet).

Fuser Unit

The part of a laser printer that fuses the toner onto the print media. It consists of a heat roller and a pressure roller. After toner is transferred onto the paper, the fuser unit applies heat and pressure to ensure that the toner stays on the paper permanently, which is why paper is warm when it comes out of a laser printer.

Gateway

A connection between computer networks, or between a computer network and a telephone line. It is very popular, as it is a computer or a network that allows access to another computer or network.

Grayscale

A shades of gray that represent light and dark portions of an image when color images are converted to grayscale; colors are represented by various shades of gray.

Halftone

An image type that simulates grayscale by varying the number of dots. Highly colored areas consist of a large number of dots, while lighter areas consist of a smaller number of dots.

HDD

Hard Disk Drive (HDD), commonly referred to as a hard drive or hard disk, is a non-volatile storage device which stores digitally-encoded data on rapidly rotating platters with magnetic surfaces.

IEEE

The Institute of Electrical and Electronics Engineers (IEEE) is an international non-profit, professional organization for the advancement of technology related to electricity.

IEEE 1284

The 1284 parallel port standard was developed by the Institute of Electrical and Electronics Engineers (IEEE). The term "1284-B" refers to a specific connector type on the end of the parallel cable that attaches to the peripheral (for example, a printer).

Intranet

A private network that uses Internet Protocols, network connectivity, and possibly the public telecommunication system to securely share part of an organization's information or operations with its employees. Sometimes the term refers only to the most visible service, the internal website.

IP address

An Internet Protocol (IP) address is a unique number that devices use in order to identify and communicate with each other on a network utilizing the Internet Protocol standard.

IPM

The Images Per Minute (IPM) is a way of measuring the speed of a printer. An IPM rate indicates the number of single-sided sheets a printer can complete within one minute.

IPP

The Internet Printing Protocol (IPP) defines a standard protocol for printing as well as managing print jobs, media size, resolution, and so forth. IPP can be used locally or over the Internet to hundreds of printers, and also supports access control, authentication, and encryption, making it a much more capable and secure printing solution than older ones.

IPX/SPX

IPX/SPX stands for Internet Packet Exchange/Sequenced Packet Exchange. It is a networking protocol used by the Novell NetWare operating systems. IPX and SPX both provide connection services similar to TCP/IP, with the IPX protocol having similarities to IP, and SPX having similarities to TCP. IPX/SPX was primarily designed for local area networks (LANs), and is a very efficient protocol for this purpose (typically its performance exceeds that of TCP/IP on a LAN).

ISO

The International Organization for Standardization (ISO) is an international standard-setting body composed of representatives from national standards bodies. It produces world-wide industrial and commercial standards.

ITU-T

The International Telecommunication Union is an international organization established to standardize and regulate international radio and telecommunications. Its main tasks include standardization, allocation of the radio spectrum, and organizing interconnection arrangements between different countries to allow international phone calls. A -T out of ITU-T indicates telecommunication.

ITU-T No. 1 chart

Standardized test chart published by ITU-T for document facsimile transmissions.

JBIG

Joint Bi-level Image Experts Group (JBIG) is an image compression standard with no loss of accuracy or quality, which was designed for

compression of binary images, particularly for faxes, but can also be used on other images.

JPEG

Joint Photographic Experts Group (JPEG) is a most commonly used standard method of lossy compression for photographic images. It is the format used for storing and transmitting photographs on the World Wide Web.

LDAP

The Lightweight Directory Access Protocol (LDAP) is a networking protocol for querying and modifying directory services running over TCP/IP.

LED

A Light-Emitting Diode (LED) is a semiconductor device that indicates the status of a machine.

MAC address

Media Access Control (MAC) address is a unique identifier associated with a network adapter. MAC address is a unique 48-bit identifier usually written as 12 hexadecimal characters grouped in pairs (e. g., 00-00-0c-34-11-4e). This address is usually hard-coded into a Network Interface Card (NIC) by its manufacturer, and used as an aid for routers trying to locate machines on large networks.

MFP

Multi Function Peripheral (MFP) is an office machine that includes the following functionality in one physical body, so as to have a printer, a copier, a fax, a scanner and etc.

MH

Modified Huffman (MH) is a compression method for decreasing the amount of data that needs to be transmitted between the fax machines to transfer the image recommended by ITU-T T.4. MH is a codebook-based run-length encoding scheme optimized to efficiently compress white space. As most faxes consist mostly of white space, this minimizes the transmission time of most faxes.

MMR

Modified Modified READ (MMR) is a compression method recommended by ITU-T T.6.

Modem

A device that modulates a carrier signal to encode digital information, and also demodulates such a carrier signal to decode transmitted information.

MR

Modified Read (MR) is a compression method recommended by ITU-T T.4. MR encodes the first scanned line using MH. The next line is compared to the first, the differences determined, and then the differences are encoded and transmitted.

NetWare

A network operating system developed by Novell, Inc. It initially used cooperative multitasking to run various services on a PC, and the network protocols were based on the archetypal Xerox XNS stack. Today NetWare supports TCP/IP as well as IPX/SPX.

OPC

Organic Photo Conductor (OPC) is a mechanism that makes a virtual image for print using a laser beam emitted from a laser printer, and it is usually green or rust colored and has a cylinder shape.

An imaging unit containing a drum slowly wears the drum surface by its usage in the printer, and it should be replaced appropriately since it gets worn from contact with the cartridge development brush, cleaning mechanism, and paper.

Originals

The first example of something, such as a document, photograph or text, etc, which is copied, reproduced or translated to produce others, but which is not itself copied or derived from something else.

OSI

Open Systems Interconnection (OSI) is a model developed by the International Organization for Standardization (ISO) for communications. OSI offers a standard, modular approach to network design that divides the required set of complex functions into manageable, self-contained, functional layers. The layers are, from top to bottom, Application, Presentation, Session, Transport, Network, Data Link and Physical.

PABX

A private automatic branch exchange (PABX) is an automatic telephone switching system within a private enterprise.

PCL

Printer Command Language (PCL) is a Page Description Language (PDL) developed by HP as a printer protocol and has become an industry standard. Originally developed for early inkjet printers, PCL has been released in varying levels for thermal, dot matrix printer, and laser printers.

PDF

Portable Document Format (PDF) is a proprietary file format developed by Adobe Systems for representing two dimensional documents in a device independent and resolution independent format.

PostScript

PostScript (PS) is a page description language and programming language used primarily in the electronic and desktop publishing areas. - that is run in an interpreter to generate an image.

Printer Driver

A program used to send commands and transfer data from the computer to the printer.

Print Media

The media like paper, envelopes, labels, and transparencies which can be used in a printer, a scanner, a fax or, a copier.

PPM

Pages Per Minute (PPM) is a method of measurement for determining how fast a printer works, meaning the number of pages a printer can produce in one minute.

PRN file

An interface for a device driver, this allows software to interact with the device driver using standard input/output system calls, which simplifies many tasks.

Protocol

A convention or standard that controls or enables the connection, communication, and data transfer between two computing endpoints.

PS

See PostScript.

PSTN

The Public-Switched Telephone Network (PSTN) is the network of the world's public circuit-switched telephone networks which, on industrial premises, is usually routed through the switchboard.

RADIUS

Remote Authentication Dial In User Service (RADIUS) is a protocol for remote user authentication and accounting. RADIUS enables centralized management of authentication data such as usernames and passwords using an AAA (authentication, authorization, and accounting) concept to manage network access.

Resolution

The sharpness of an image, measured in Dots Per Inch (DPI). The higher the dpi, the greater the resolution.

SMB

Server Message Block (SMB) is a network protocol mainly applied to share files, printers, serial ports, and miscellaneous communications between nodes on a network. It also provides an authenticated Inter-process communication mechanism.

SMTP

Simple Mail Transfer Protocol (SMTP) is the standard for e-mail transmissions across the Internet. SMTP is a relatively simple, text-based protocol, where one or more recipients of a message are specified, and then the message text is transferred. It is a client-server protocol, where the client transmits an email message to the server.

SSID

Service Set Identifier (SSID) is a name of a wireless local area network (WLAN). All wireless devices in a WLAN use the same SSID in order to communicate with each other. The SSIDs are case-sensitive and have a maximum length of 32 characters.

Subnet Mask

The subnet mask is used in conjunction with the network address to determine which part of the address is the network address and which part is the host address.

TCP/IP

The Transmission Control Protocol (TCP) and the Internet Protocol (IP); the set of communications protocols that implement the protocol stack on which the Internet and most commercial networks run.

TCR

Transmission Confirmation Report (TCR) provides details of each transmission such as job status, transmission result and number of pages sent. This report can be set to print after each job or only after failed transmissions.

TIFF

Tagged Image File Format (TIFF) is a variable-resolution bitmapped image format. TIFF describes image data that typically come from scanners. TIFF images make use of tags, keywords defining the characteristics of the image that is included in the file. This flexible and platform-independent format can be used for pictures that have been made by various image processing applications.

Toner Cartridge

A kind of bottle or container used in a machine like a printer which contains toner. Toner is a powder used in laser printers and photocopiers, which forms the text and images on the printed paper. Toner can be fused by a combination of heat/pressure from the fuser, causing it to bind to the fibers in the paper.

TWAIN

An industry standard for scanners and software. By using a TWAIN-compliant scanner with a TWAIN-compliant program, a scan can be initiated from within the program. It is an image capture API for Microsoft Windows and Apple Macintosh operating systems.

UNC Path

Uniform Naming Convention (UNC) is a standard way to access network shares in Window NT and other Microsoft products. The format of a UNC path is: \\<servername>\<sharename>\<Additional directory>

URL

Uniform Resource Locator (URL) is the global address of documents and resources on the Internet. The first part of the address indicates what protocol to use, the second part specifies the IP address or the domain name where the resource is located.

USB

Universal Serial Bus (USB) is a standard that was developed by the USB Implementers Forum, Inc., to connect computers and peripherals. Unlike the parallel port, USB is designed to concurrently connect a single computer USB port to multiple peripherals.

Watermark

A watermark is a recognizable image or pattern in paper that appears lighter when viewed by transmitted light. Watermarks were first introduced in Bologna, Italy in 1282; they have been used by papermakers to identify their product, and also on postage stamps, currency, and other government documents to discourage counterfeiting.

WEP

Wired Equivalent Privacy (WEP) is a security protocol specified in IEEE 802.11 to provide the same level of security as that of a wired LAN. WEP provides security by encrypting data over radio so that it is protected as it is transmitted from one end point to another.

WIA

Windows Imaging Architecture (WIA) is an imaging architecture that is originally introduced in Windows Me and Windows XP. A scan can be initiated from within these operating systems by using a WIA-compliant scanner.

WPA

Wi-Fi Protected Access (WPA) is a class of systems to secure wireless (Wi-Fi) computer networks, which was created to improve upon the security features of WEP.

WPA-PSK

WPA-PSK (WPA Pre-Shared Key) is special mode of WPA for small business or home users. A shared key, or password, is configured in the wireless access point (WAP) and any wireless laptop or desktop devices. WPA-PSK generates a unique key for each session between a wireless client and the associated WAP for more advanced security.

WPS

The Wi-Fi Protected Setup (WPS) is a standard for establishing a wireless home network. If your wireless access point supports WPS, you can configure the wireless network connection easily without a computer.

XPS

XML Paper Specification (XPS) is a specification for a Page Description Language (PDL) and a new document format, which has benefits for portable document and electronic document, developed by Microsoft. It is an XML-based specification, based on a new print path and a vector-based device-independent document format.