

(Intenso)[®]

Intenso TAB 734

Long Manual



V1.0

Bedienungsanleitung TAB 734

Vielen Dank, dass Sie sich für das **TAB 734** entschieden haben. Folgen Sie bitte dieser Anleitung, um über die wichtigsten Funktionen des Gerätes informiert zu werden.



1.) Inhaltsverzeichnis

1.) Inhaltsverzeichnis	1
2.) Hinweise	2
3.) Geräteüberblick	4
4.) Packungsinhalt	4
5.) Laden des Akkus	5
6.) Nutzung einer Micro SD/SDHC/SDXC Karte	5
7.) Übertragung von Daten zwischen dem Gerät und einem Computer	5
8.) Touchscreen	6
9.) WIFI	6
Automatische Verbindung	6
Manuelle Verbindung	7
10.) Der Startbildschirm	8
Ansicht	8
Entsperrn des Displays	8
Statusleisten	9
Anpassung des Startbildschirms	10
Verschiedene Startbildschirme nutzen	10
Vorinstallierte Anwendungen auf dem Startbildschirm	11
11.) Anwendungsübersicht	11
12.) Versand / Empfang von E-Mails	12
Einrichtung Ihres E-Mail Postfaches	12
Verwaltung der E-Mail Accounts	13
Anzeige von E-Mail Nachrichten	13
Schreiben von E-Mail Nachrichten	13
13.) Web Browser	14
Nutzung der virtuellen Tastatur	14
Nutzung des Web Browsers	15
14.) System Einstellungen	15
Einstellungsübersicht der wichtigsten Einstellungen	16
15.) Verwaltung von Anwendungen	17
Installation von Anwendungen	17
Deinstallation von Anwendungen	17
16.) Datei Explorer	18
Durch Dateien und Ordner navigieren	18
Die Toolbar nutzen	18
Dateien und Ordner kopieren, verschieben und umbenennen	18
17.) Eingeschränkte Garantiebedingungen	19
18.) Technische Daten	19
19.) Wartung des Gerätes	20
20.) Säuberung des Gerätes	20
21.) Entsorgung von Elektro-Altgeräten	20
22.) Lizenzinformation	21
EG Konformitätserklärung	25

Dieses Handbuch enthält unter Umständen nicht alle Funktionen Ihres Gerätes. Für die Nutzung von Anwendungen die von Drittanbietern stammen, kontaktieren Sie bitte den Anbieter. Bitte beachten Sie, dass alle Angaben ohne vorherige Ankündigung geändert werden können. Aktuelle Informationen finden Sie unter www.intenso.de

Markenzeichen

Google™, das Google™-Logo und Android™ sind Marken von Google™. Alle anderen Produkt- oder Servicennamen sind Eigentum ihrer jeweiligen Inhaber.

2.) Hinweise

- Vermeiden Sie einen harten Aufprall des Gerätes. Legen Sie es nicht auf schräge Flächen, um einen Sturz des Gerätes zu vermeiden.
- Verwenden Sie das Gerät nicht in extrem kalten, heißen, feuchten oder staubigen Gebieten. Setzen Sie es ebenfalls keinen direkten Sonnenstrahlen aus.
- Vermeiden Sie die Nutzung auf sandigen Plätzen.
- Verwenden Sie das Gerät nicht in explosionsgefährdeten Umgebungen, wie zum Beispiel an den Zapfsäulen einer Tankstelle.
- Vermeiden Sie die Benutzung auf Kissen, Sofas oder anderen Gegenständen, die eine Wärmeentwicklung unterstützen, da die Gefahr einer Überhitzung des Gerätes besteht.
- Führen Sie häufiger Datensicherungen durch, um einen möglichen Datenverlust zu vermeiden. Wir sind nicht haftbar für einen eventuellen Datenverlust.
- Trennen Sie die Verbindung nicht, wenn Daten übertragen werden oder das Gerät formatiert wird. Dies kann zu Datenverlust führen.
- Bilder und Filme können durch Rechte Dritter geschützt sein. Das Abspielen ohne Lizenz kann Copyright Rechte verletzen.
- Vermeiden Sie das Benutzen in stark magnetisierten Feldern.
- Schützen Sie das Gerät vor Nässe. Wenn Feuchtigkeit in das Gerät eintritt, schalten Sie es bitte unverzüglich aus, danach säubern und trocknen Sie bitte das Gerät.
- Verwenden Sie bitte keine chemischen Lösungen, um das Gerät zu säubern. Hier bitte nur ein trockenes Tuch verwenden.
- Keine offenen Flammen, beispielsweise angezündete Kerzen, in die Nähe oder auf dem Gerät platzieren.
- Wir sind nicht haftbar für Schäden bei einer Fehlfunktion, für Datenverlust, fehlerhafter Handhabung, eigenhändiger Reparatur des Gerätes oder Wechseln des Akkus.
- Sollte das Gerät einmal nicht auf Ihre Eingaben reagieren, benutzen Sie bitte den Reset-Knopf auf der Rückseite des Gerätes, um es neu zu starten.
- Bei Nichtverwendung trennen Sie bitte das Netzteil von der Stromversorgung.
- Die Steckdose muss sich in der Nähe des Gerätes befinden und leicht zugänglich sein.
- Betreiben Sie den Netzadapter nur an geerdeten Steckdosen mit AC 100-240V~, 50/60 Hz. Wenn Sie sich der Stromversorgung am Aufstellungsort nicht sicher sind, fragen Sie beim betreffenden Energieversorger nach.
- Benutzen Sie nur das beiliegende Netzadapter- und Netzanschlusskabel.
- Um die Stromversorgung zu Ihrem Gerät zu unterbrechen, ziehen Sie das Netzteil aus der Steckdose. Halten Sie beim Abziehen immer das Netzteil selbst fest. Ziehen Sie nie an der Leitung.

- Öffnen Sie nicht das Gehäuse des Netzadapters. Bei geöffnetem Gehäuse besteht Lebensgefahr durch elektrischen Schlag. Es enthält keine zu wartenden Teile.
- Bei längerer Nichtverwendung entlädt sich der Akku des Gerätes langsam. Vor der Wiederverwendung muss dieser erneut aufgeladen werden.
- Bitte beachten Sie die umweltgerechte Entsorgung des Gerätes oder des Akkus.
- Bitte zerlegen Sie das Gerät nicht in Einzelteile, und versuchen Sie bitte nicht, es selbst zu reparieren, da die Garantie in diesem Fall erlischt.
- Nutzen Sie das Gerät nicht an Orten, wo die Nutzung von Mobilgeräten verboten ist. Nutzen Sie das Gerät nicht in der Nähe anderer elektronischer Geräte, da es durch die Hochfrequenzsignale zu Störungen kommen kann.
- Nutzen Sie das Gerät nicht in der Nähe eines Schrittmachers, in einem Krankenhaus oder in der Nähe medizinischer Geräte, da es durch die Hochfrequenzsignale zu Störungen kommen kann. Halten Sie mindestens 15cm Abstand von einem Schrittmacher. Wenden Sie sich bitte an den Hersteller dieser Geräte, um Informationen über die gemeinsame Nutzung zu erhalten.
- Bitte beachten Sie, dass eine dauerhaft hohe Lautstärke zu bleibenden Hörschäden führen kann. Um ein mögliches Gesundheitsrisiko durch zu hohe Lautstärke zu vermeiden, empfehlen wir Ihnen nur die beigefügten Kopfhörer zu verwenden.
- Aus Gründen der Verkehrssicherheit darf das Gerät während der Fahrt nicht vom Fahrzeugführer selbst bedient werden.

3.) Geräteüberblick

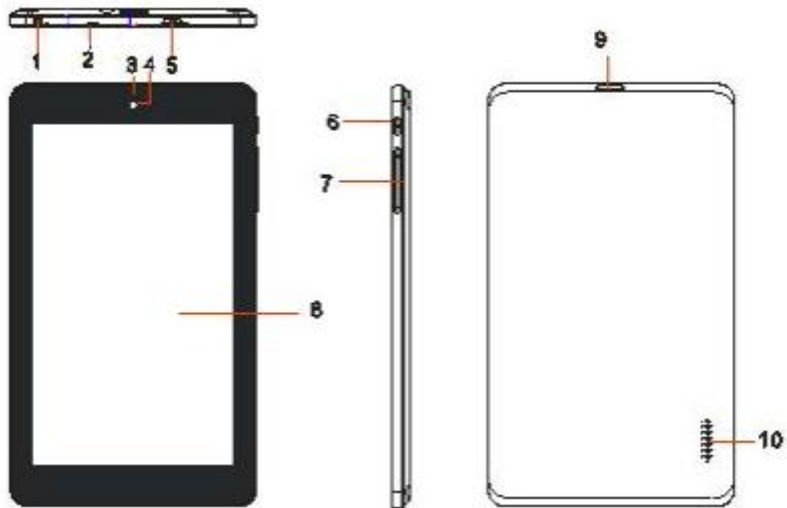

- (1) **3.5mm Kopfhörerbuchse**
- (2) **Integriertes Mikrofon**
- (3) **Ladestatus LED.** Leuchtet während des Ladens rot auf. Leuchtet gelb, sobald der Akku vollständig aufgeladen wurde.
- (4) **Front Kamera**
- (5) **Micro-USB Buchse**

- (6) **Ein / Aus Taste:** Lange drücken, um das Ausschaltmenü zu öffnen; kurz drücken, um das Display aus dem Ruhemodus zu reaktivieren.
- (7) **Lautstärke + / -**
- (8) **Touchscreen**
- (9) **Micro-SD Kartenslot**
- (10) **Lautsprecher**

4.) Packungsinhalt

Bitte **überprüfen** Sie den **Packungsinhalt** auf **Vollständigkeit**:

- TAB 734
- USB Kabel
- Netzteil 5V 1.2A
- Bedienungsanleitung

5.) Laden des Akkus

Bitte **laden** Sie den **Akku** des Gerätes **vor** der **ersten Benutzung vollständig** auf. **Verbinden** Sie dazu das beiliegende **Netzteil** mit dem **Gerät** und einer **Steckdose**. Das **vollständige Laden** dauert ca. **5 Stunden**. Der **Ladezustand** wird an der **vorderen, linken Seite** des Geräts angezeigt. Die **LED** leuchtet **während des Aufladens Rot** und **wechselt zu Gelb**, wenn der **Akku vollständig geladen ist**.

Hinweise:

- a. Bei 15% verbleibender Restleistung des Akkus erhalten Sie eine Warnmeldung auf das Display. Sie sollten das Gerät nun zum Aufladen des Akkus über das Netzteil mit einer Steckdose verbinden, um eventuellen Datenverlust zu vermeiden und die Lebensdauer des Akkus zu erhöhen.
 - b. Sie können das Gerät nutzen, während Sie die Batterie aufladen. Um eine langanhaltende Batterie-Lebensdauer zu gewährleisten, bitten wir Sie, das Gerät nicht zu nutzen.
 - c. Um eine gute Performance zu gewährleisten, muss der eingebaute Akku häufig genutzt werden. Wenn Sie das Gerät nur selten gebrauchen, laden Sie den Akku bitte mindestens einmal im Monat vollständig auf.
 - d. Stellen Sie sicher, dass Sie nur das mitgelieferte Netzteil zum Aufladen benutzen.
-

6.) Nutzung einer Micro SD/SDHC/SDXC Karte

Dieses Gerät kann Daten **direkt** von einer **Micro SD/SDHC/SDXC Karte** mit einer **maximalen Kapazität** von **64 GB** lesen. Um eine **Micro SD/SDHC Karte** zu nutzen, stecken Sie bitte die Karte in den dafür vorgesehenen Micro SD Slot auf der **linken Seite des Gerätes**. Nutzen Sie den **vorinstallierten Explorer**, um auf die auf der **Speicherkarte** vorhandenen **Daten** zuzugreifen. Bitte wählen Sie hierzu im **Explorer** das **Verzeichnis „SD Card“** aus.

7.) Übertragung von Daten zwischen dem Gerät und einem Computer

- 1.) Verbinden Sie das **Gerät** mit Hilfe des beiliegenden **USB Kabels** mit einem **Computer**.
- 2.) Auf dem Gerät wird nun der **Bildschirm** für die **USB Verbindung** angezeigt. Tippen Sie **kurz** auf „**USB-Speicher aktivieren**“. Das Gerät wird **als Wechseldatenträger** erkannt und Sie erhalten die Info „**USB-Speicher in Verwendung**“. Nach **kurzem** Tippen auf die **Home-Taste** können Sie Ihr Gerät **normal weiternutzen**. Sie haben nun **von Ihrem Computer** Zugriff auf den **internen Speicher** des **Gerätes** und können **Dateien** auf das Gerät **kopieren, löschen oder verschieben**.
- 3.) Wenn eine **USB Verbindung** mit dem Computer **besteht**, wird Ihnen in der **Statusleiste** oben links ein **USB Symbol** angezeigt. In der **erweiterten Statusleiste** (zum Öffnen bitte die Leiste mit dem Finger nach unten ziehen) bekommen Sie **zusätzliche Informationen** und können die USB Verbindung **aktivieren** bzw. **deaktivieren**.
 - Um den Speicher zu **deaktivieren**, wählen Sie **„USB-Speicher deaktivieren“** aus.
 - Wählen Sie beim Computer die **Funktion „Sicher Entfernen“**  aus, um das **Gerät vom Computer zu trennen**.

Hinweis: Die vorinstallierten Anwendungen und das Android™ Betriebssystem nehmen einen Teil des vorhandenen internen Speichers ein. Aus diesem Grunde steht Ihnen nicht der gesamte interne Speicher zur Verfügung.

8.) Touchscreen

Dieses Gerät wird über einen **Touchscreen** gesteuert. Sie können mit Ihren **Fingern** durch **leichtes Tippen** auf den **Touchscreen** ganz einfach **Anwendungen starten, Texte auf der virtuellen Tastatur eingeben** und durch **wischen in die jeweilige Richtung** zwischen den **einzelnen Startbildschirmen** wechseln.



Bitte **entfernen** Sie die **Display Schutzfolie** vor der **Verwendung** des Gerätes.

Der **Touchscreen** erkennt geringe **elektrische Ladungen**, wie sie beispielsweise vom menschlichen Finger abgegeben wird und **bestimmt** so den **Eingabepunkt**.

Nutzen Sie für die **Eingabe** also idealerweise Ihre **Fingerspitzen**. Die Bedienung mit **einem Stift oder anderen spitzen Gegenständen** ist nicht möglich.

Der **Touchscreen** sollte **nicht** mit Wasser oder anderen elektrischen Vorrichtungen **in Berührung kommen**, um **Fehlfunktionen** und **dauerhafte Defekte zu vermeiden**.

Hinweise:

- a. Wird der Touchscreen zwei Minuten lang nicht bedient, wechselt das Gerät in den Standby Modus. Drücken Sie kurz die Ein / Aus Taste, um in den aktiven Modus zu wechseln.
 - b. Um ungewünschte Eingaben zu verhindern, ist automatisch eine Tastensperre aktiviert. Entriegeln Sie bitte die Tastensperre auf dem Touchscreen. Berühren Sie das **geschlossene Schloss**  auf dem Display und **halten** Sie dieses **gedrückt**. **Ziehen** Sie nun das **Schloss** auf das soeben erscheinende **geöffnete Schloss**  und **lösen** Sie dann Ihren **Finger vom Display**. Der **Bildschirm ist nun entsperrt**.
-

Sie können das Gerät in **alle Richtungen** drehen. Es verfügt über einen **Sensor**, der das **Display automatisch ausrichtet**.

9.) WIFI

Um das Gerät **mit dem Internet** zu verbinden, benötigen Sie eine **WLAN Verbindung**. Um diese herzustellen, öffnen Sie in den **Einstellungen** die **WLAN Einstellungen**.

Hinweis: Bitte beachten Sie, dass sich ein **WLAN Netz** in **Reichweite ihrer aktuellen Position befinden muss**.

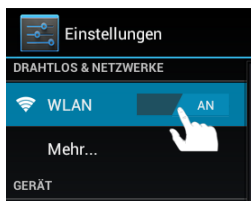

Automatische Verbindung

Öffnen Sie über die **Einstellungen** die **WLAN** Einstellungen. Hier können Sie die **WLAN Funktion** ganz einfach **aktivieren** oder **deaktivieren**. Schieben Sie den **virtuellen Schalter** einfach aus der **Position „An“** nach links, um die WLAN Funktion zu **deaktivieren**. Die Anzeige **wechselt** nun zu „Aus“.

Um die **deaktivierte WLAN Funktion** wieder zu **aktivieren**, schieben Sie den **virtuellen Schalter** einfach nach rechts.

In den **WLAN-Einstellungen** werden Ihnen auf der rechten Seite alle **verfügbaren Netzwerke** sowie **alle bereits genutzten Netzwerke** angezeigt.

Tippen Sie bitte auf das **gewünschte Netzwerk** und geben Sie gegebenenfalls den passenden **WLAN Schlüssel** (Passwort) ein, um eine **Verbindung herzustellen**.

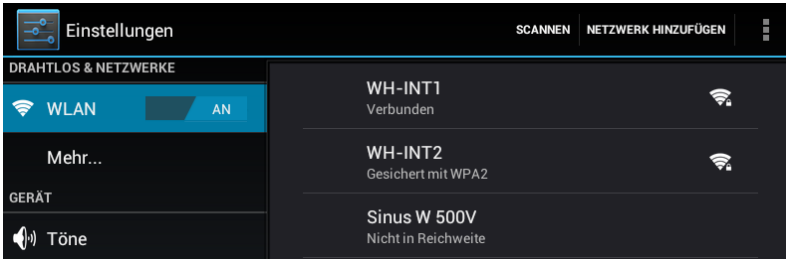

Bestätigen Sie das gegebenenfalls eingegebene Passwort durch tippen auf die **Enter Taste** und tippen Sie nun auf **Verbinden**. Nach einem **kurzen Moment** ist die **Verbindung hergestellt**.

Hinweise:

- a) Wenn das Gerät in den Standby Modus wechselt, wird WLAN automatisch deaktiviert. Dies verringert den Stromverbrauch und führt so automatisch zu einer längeren Akkulaufzeit. Wenn das Gerät wieder in den aktiven Modus wechselt, wird automatisch die WLAN Verbindung wiederhergestellt. Dies kann einige Sekunden dauern.*
 - b) Die Liste der aktuell auffindbaren WLAN Netzwerke wird automatisch aktualisiert.*
 - c) Wenn die WLAN Funktion aktiviert ist, verbindet sich das Gerät automatisch mit einem bereits konfigurierten Netzwerk, sofern es sich in Reichweite befindet.*
 - d) Wenn sich ein unbekanntes WLAN Netzwerk in Reichweite befindet, wird ein Informationsfeld eingeblendet.*
-

Manuelle Verbindung

Um manuell nach einem **erreichbaren** WLAN Netz zu **suchen**, gehen Sie bitte wie folgt vor:



- (1) Öffnen Sie die **Einstellungen**.
- (2) Öffnen Sie jetzt die **WLAN-Einstellungen** und tippen Sie auf die drei Punkte oben rechts und wählen Sie anschließend **„Scannen“**.
- (3) Sollte das WLAN Netz **nicht** in der **Liste der verfügbaren Netzwerke** erscheinen, **wählen** Sie den Punkt **„Netzwerk hinzufügen“** aus, um von Hand die **Netzwerk SSID**, das **Sicherheitsprotokoll** und das gegebenenfalls zugehörige **Passwort** einzugeben. Zur **Bestätigung** Ihrer **Eingaben** tippen Sie bitte auf **„Speichern“**.

10.) Der Startbildschirm

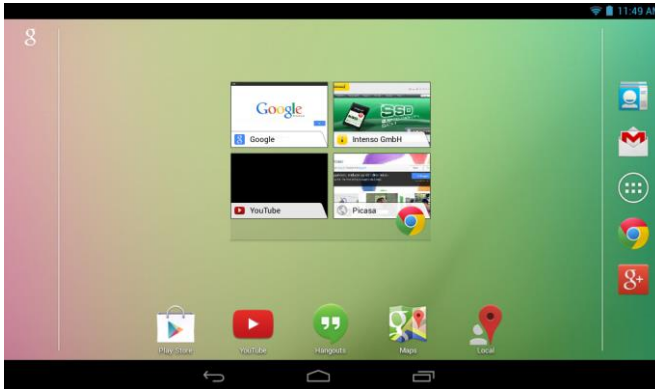
Ansicht



Entsperren des Displays

Wird der Touchscreen **zwei Minuten lang nicht bedient**, wechselt das Gerät in den **Standby Modus**. Drücken Sie **kurz die Ein / Aus Taste**, um in den **aktiven Modus** zu wechseln. Das **Display** ist zum **Schutz vor ungewünschten Eingaben** gesperrt. Berühren Sie das **geschlossene Schloss**  auf dem Display und **halten** Sie dieses **gedrückt**. Ziehen Sie nun das **Schloss** auf das soeben erscheinende **geöffnete Schloss**  und **lösen** Sie dann Ihren **Finger vom Display**. Der **Bildschirm** ist nun **entsperrt**.

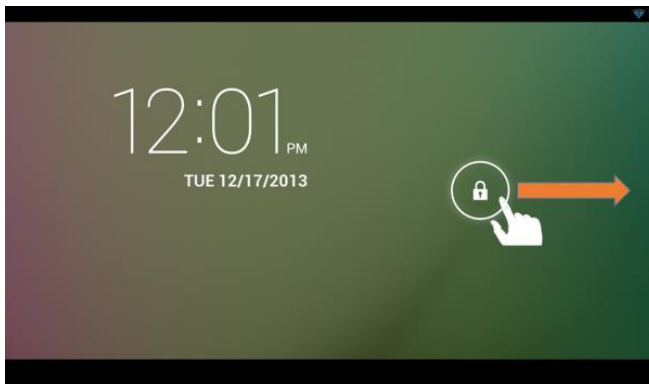

Ziehen Sie das Schloss Symbol mit Ihrem Finger in Pfeilrichtung

Hinweis: Ziehen Sie das Schloss Symbol zum erscheinenden **Kamera Symbol**, um **direkt die Kameraanwendung** zu öffnen.

Statusleisten

Die **Statusleisten** finden Sie im **oberen** und **unteren Bereich** des **Startbildschirms**.

Die **obere Statusleiste** teilt sich in **zwei Bereiche**. Ziehen Sie die Leiste auf der **linken Seite** herunter, werden Ihnen, falls vorhanden, die **aktuellen Benachrichtigungen** angezeigt.

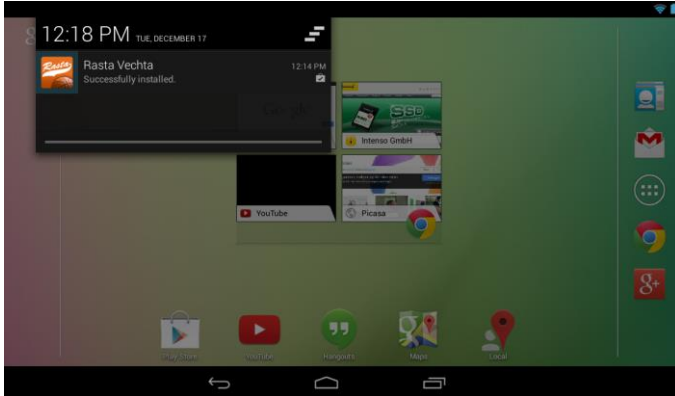

Ziehen Sie die Leiste auf der **rechten Seite** herunter, werden Ihnen die **Schnellzugriffsfelder für verschiedene Einstellungen** angezeigt.

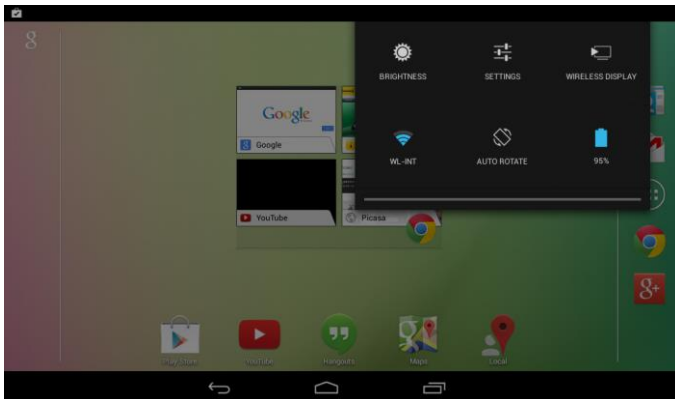

In der **unteren Statusleiste** haben Sie die Möglichkeit, zur **vorherigen Anzeige** zu wechseln, oder die gegebenenfalls eingeblendete **Tastatur auszublenden**, direkt den **Startbildschirm aufzurufen** und die **zuletzt genutzten Programme** angezeigt zu bekommen.



Anpassung des Startbildschirms

Sie können Ihren **Startbildschirm** ganz einfach an Ihre **individuellen Bedürfnisse** anpassen. Wenn Sie ein **Icon löschen** möchten, tippen Sie etwas **länger** mit Ihrem **Finger** auf das **Icon** und **schieben** Sie es dann in das eingeblendete **X-Symbol**. Nehmen Sie den **Finger nun vom Touchscreen** und das **Icon wird gelöscht**.

Wenn Sie ein **Icon aus der Anwendungsübersicht auf den Startbildschirm positionieren** wollen, tippen Sie **in der Anwendungsübersicht** etwas **länger** auf das **Icon** und der **Startbildschirm** erscheint. **Schieben** Sie das **Icon** an die **gewünschte Stelle** und **lösen Sie den Finger vom Touchscreen**. Das **Icon** wurde nun dem Startbildschirm **hinzugefügt**. Wenn Sie ein Icon auf ein anderes Icon legen, wird automatisch ein Ordner mit beiden Icons angelegt. Tippen Sie auf den Ordner, um alle darin abgelegten Icons angezeigt zu bekommen und wählen Sie dann das gewünschte Icon durch kurzes Tippen aus.

Sie können dem **Startbildschirm** außerdem **Widgets** hinzufügen. Öffnen Sie dazu bitte die **Anwendungsübersicht**. Tippen Sie als nächstes auf das Wort **Widgets**. Es werden Ihnen nun alle **auf dem Gerät verfügbaren Widgets** angezeigt. Das **Hinzufügen** eines **Widgets** auf den **Startbildschirm** funktioniert genau, wie das **Hinzufügen** eines **Icons**.

Wenn Sie das Hintergrundbild ändern möchten, tippen Sie einfach auf eine freie Stelle auf einem Startbildschirm und halten Sie den Finger solange auf das Display gedrückt, bis das Hintergrundauswahlmenü erscheint.

Verschiedene Startbildschirme nutzen

Ihnen stehen **fünf individuell einzurichtende Startbildschirme** zur Verfügung. Durch eine **leichte Wischbewegung nach links oder rechts**, können Sie ganz leicht zwischen Ihnen **wechseln**.

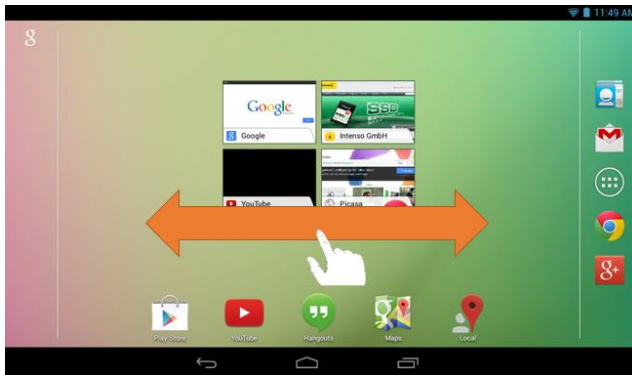

Durch Drücken der Home-Taste gelangen Sie immer automatisch zum mittleren Startbildschirm zurück.

Vorinstallierte Anwendungen auf dem Startbildschirm

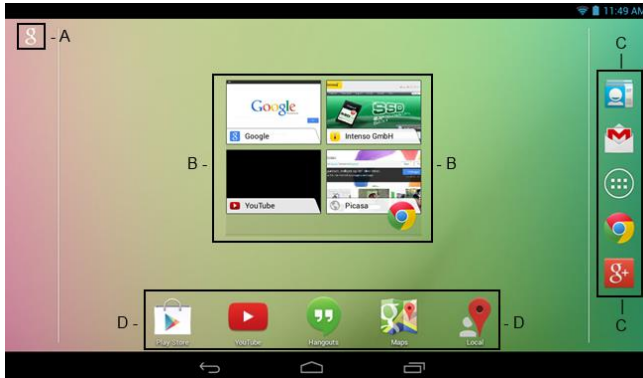

A Verknüpfung zur Google™ Suche

B Lesezeichen Übersicht für den Chrome™ Browser

C Kontakte, Gmail™, Anwendungsübersicht, Chrome™ und Google+™

D Google Playstore™ , YouTube™ , Hangouts™ , Maps™ , und Local™

11.) Anwendungsübersicht



Tippen Sie **kurz** auf das **Anwendungsübersicht Icon**, um die **Anwendungsübersicht** zu **öffnen**. Sie sehen nun eine **Übersicht** aller **vorinstallierten** und bereits von Ihnen **installierten Anwendungen**. Öffnen Sie die **gewünschte Anwendung** durch **kurzes** Tippen auf das entsprechende **Icon**.

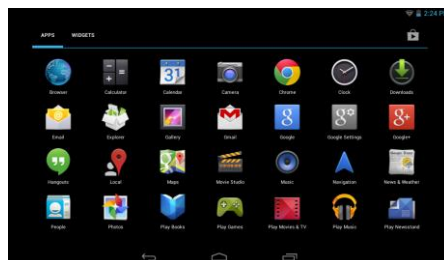

Anwendungsübersicht

12.) Versand / Empfang von E-Mails

Auf diesem Gerät ist eine **E-Mail Anwendung** vorinstalliert. Sie können damit Ihre bereits **bestehende** E-Mail Adresse **nutzen**, um E-Mails zu **versenden** und zu **empfangen**.

Hinweis: Für diese Funktion ist eine WLAN Verbindung zum Internet erforderlich.

Öffnen Sie die Anwendung über das „**E-Mail**“ Icon, welches Sie im **Anwendungsmenü** finden.

Einrichtung Ihres E-Mail Postfaches

- (1) **Starten** Sie die E-Mail Anwendung durch **Tippen** auf das **E-Mail** Symbol. Sie werden nun aufgefordert Ihr **E-Mail Postfach einzurichten**.
- (2) Geben Sie Ihre **E-Mail Adresse** sowie Ihr **zugehöriges Passwort** ein und tippen Sie dann auf „**Weiter**“. Anschließend **benennen** Sie Ihr **Konto** und **legen** Ihren **angezeigten Namen für ausgehende Nachrichten fest**. Tippen Sie auf „**Fertig**“ um die **Einrichtung abzuschließen**. Ihr **E-Mail Postfach** wird als **Standard Postfach** ausgewählt, wenn Sie die Option **“E-Mails standardmäßig von diesem Konto senden”** auswählen.
- (3) Sie können Ihr **E-Mail Postfach** auch **manuell** einrichten. Geben Sie Ihre **E-Mail Adresse** und Ihr **zugehöriges Passwort** ein und tippen Sie **anschließend** auf **“Manuelles Setup”**, um die **E-Mail Server Informationen** einzugeben.
- (4) **Wählen** Sie zwischen den **Servertypen POP3, IMAP oder Exchange** für **eingehende E-Mails** aus.

Hinweis: Wenn Sie nicht wissen, welche Einstellungen Sie vornehmen müssen, kontaktieren Sie bitte Ihren E-Mail Provider, Ihren Netzwerkadministrator oder suchen Sie mit Begriffen wie etwa „POP Adresse“ und „Namen Ihres Provider“ nach den benötigten Informationen im Internet.



- (5) Geben Sie die benötigten **Informationen** ein (Server, Port etc.).
- (6) Wählen Sie den **Servertyp** für **ausgehende E-Mails** aus und geben Sie die **benötigten Informationen** ein.
- (7) Tippen Sie **“Weiter”**, um im **Menü fortzufahren**. Die E-Mail Anwendung **überprüft** nun die getätigten **Server Einstellungen**. Nach **erfolgreichem Anlegen** sehen Sie die Meldung **“Your account is set up, and email is on its way”**. Ihr Konto ist jetzt **eingrichtet**.
- (8) Vergeben Sie einen **Namen** für Ihr **Postfach** und tippen Sie auf „**Fertig**“, um den Vorgang **abzuschließen**.

Hinweis: Sollten Sie mehr als einen Email Account besitzen, wird bei jedem Start der E-Mail Anwendung das Standard Konto aufgerufen.

Verwaltung der E-Mail Accounts

Hinzufügen eines neuen Postfaches:

- (1) Öffnen Sie die **E-Mail Anwendung** und tippen Sie auf die **Menü Taste**  zum Anzeigen der **weiteren Optionen**. Wählen Sie den Menüpunkt „**Einstellungen**“ und anschließend **“Konto hinzufügen”**, um ein neues **Postfach** anzulegen.
- (2) Folgen Sie dem **Einrichtungsassistenten**, um ein **neues Postfach** anzulegen.

Löschen eines Postfaches:

- (1) Öffnen Sie die **E-Mail Anwendung** und tippen Sie auf die **Menü Taste**  zum Anzeigen der **weiteren Optionen**. Wählen Sie den Menüpunkt „Einstellungen“ und anschließend **“Konto entfernen”**, um das gewünschte **Postfach** zu löschen.

Überprüfen der Kontoeigenschaften:

- (1) Öffnen Sie die **E-Mail Anwendung** und tippen Sie auf die **Menü Taste**  zum Anzeigen der **weiteren Optionen** und wählen Sie „**Einstellungen**“ aus. Auf der **linken Seite** des Menüs werden jetzt **alle bereits angelegten Postfächer** angezeigt.
- (2) Tippen **auf das gewünschte Postfach**, um die Kontoeinstellungen anzuzeigen.
- (3) Tippen Sie auf die zu ändernde **“Kontoeinstellung”**, um die gewünschten **Einträge vorzunehmen**.

Anzeige von E-Mail Nachrichten

Öffnen Sie die **E-Mail Anwendung** durch **kurzes Tippen** auf das **E-Mail Icon**. Ihr **bereits angelegtes Postfach** wird nun **angezeigt**.

- Durch eine **vertikale Wischbewegung** können Sie durch Ihre E-Mails **scrollen**.
- Tippen Sie **kurz** auf eine **bestimmte E-Mail**, um diese zu **öffnen**.
- Tippen und **halten** Sie den Finger **auf einer bestimmten E-Mail Nachricht**, um **weitere Optionen** angezeigt zu bekommen. Es erscheint nun ein **Infofeld**. Hier können Sie jetzt die **E-Mail öffnen**, **beantworten**, **weiterleiten** oder **löschen**.

Schreiben von E-Mail Nachrichten

- (1) Tippen Sie in der E-Mail Übersicht auf das **Email Symbol** in der **oberen Menüleiste** und es öffnet sich ein **neues Fenster**, indem Sie eine neue **Email verfassen** können.
- (2) Geben Sie nun die **E-Mail Adresse** des **Empfängers**, einen **Betreff** und den **Text** in die dafür **vorgesehenen Felder** ein. Sie können ebenfalls **„Cc/Bcc“** hinzufügen, um eine E-Mail an mehrere User zu schreiben.
- (3) Tippen Sie auf **„Senden“**, um die **E-Mail abzuschicken**. Tippen Sie auf **„Speichern“**, um die eingegebene **E-Mail als Entwurf zu speichern**. Wenn Sie auf das **„Mülleimer Symbol“** tippen, wird die **aktuell eingegebene E-Mail** wieder **entfernt**.

13.) Web Browser

Um den **Web Browser** zu starten, tippen Sie bitte auf das **Browser Icon**  in der Anwendungsübersicht.

Um eine **Internetseite** zu öffnen, tippen Sie bitte auf das **Eingabefeld** für die **Internetadresse**. Die **virtuelle Tastatur** öffnet sich nun und Sie können jetzt die **Adresse** der gewünschten **Internetseite** eingeben. Tippen Sie auf die Enter-Taste, um Ihre Eingabe zu bestätigen und die **Internetseite** zu öffnen.

Hinweis: Nicht alle Netzwerke bieten einen Internetzugriff. Einige Netzwerke bieten nur einen Zugriff auf andere verbundene lokale Rechner und keine Internetverbindung.

Nutzung der virtuellen Tastatur

Tippen Sie auf das **Eingabefeld** zum Öffnen der **virtuellen Tastatur**. Sie können nun **Texte eingeben** oder **Internetseiten aufrufen**.





- Caps Lock (Groß- und Kleinschreibung)
- Rücksprungtaste
- Aufruf des Menüs für die Nummern, Zeichen und Sonderzeichen Eingabe
- Space Taste (Leerzeicheneingabe)
- Enter Taste (Bestätigung Ihrer Eingabe)

Eingabe von Sonderzeichen

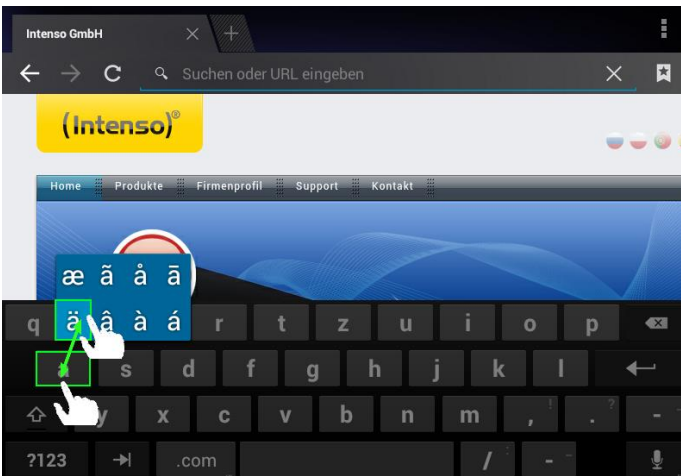
Um ein **Sonderzeichen** wie etwa „ä“ einzugeben, tippen Sie **lange** mit Ihrem **Finger** auf die Taste „a“ um das **Sonderzeichenmenü** aufzurufen. Gleiten Sie nun mit dem Finger auf das gewünschte Sonderzeichen, beispielsweise das „ä“ und lösen Sie den Finger wieder vom Display. Sie haben nun ein „ä“ eingegeben.





Nutzung des Web Browsers

- Sie können durch die **Anzeige im Display** scrollen, indem Sie eine **vertikale Wischbewegung** mit Ihrem **Finger** durchführen. Bitte **beginnen** Sie die Wischbewegung **nicht** auf einem **Menüpunkt** oder **Link**, da ansonsten die **vorhandene Verknüpfung** geöffnet werden würde.
- Um einen **Internetlink** zu öffnen, tippen Sie ganz einfach auf den **Link**. Die neue **Seite** öffnet sich **automatisch**.
- Um das **Web Browser Menü** zu öffnen, drücken Sie bitte die **Menü-Taste** . Hier stehen Ihnen verschiedene Funktionen zur Verfügung. Unter anderem können Sie hier **die geöffnete Webseite aktualisieren**, **einen neuen Tab öffnen**, **Webseiten offline lesbar machen** oder zu den **Web Browser Einstellungen** wechseln.
- Um zu der **vorherigen Seite zurückzugehen**, drücken Sie bitte die **Zurück-Taste** .
- Um **direkt zum Startbildschirm** zurückzukehren, drücken Sie bitte auf die **Home-Taste** .
- Um einen **Text** einzugeben, tippen Sie auf das **entsprechende Feld** und nutzen Sie die **virtuelle Tastatur zur Eingabe des Textes**.

Hinweis: Für diese Funktion ist eine **WLAN Verbindung** zum Internet **erforderlich**.

14.) System Einstellungen

Tippen Sie im **Anwendungsmenü** auf das **Einstellungen Icon**, um die **System Einstellungen** aufzurufen.

- Auf der **linken Seite des Menüs** finden Sie die einzelnen **Kategorien**. Durch **kurzes Drücken** auf den jeweils ausgewählten **Menüeintrag**, werden die **verfügbaren Einstellmöglichkeiten** angezeigt. Beachten Sie bitte, dass eventuell nicht alle von Android™ angebotenen Funktionen mit diesem Gerät kompatibel sind.
- Wenn Sie **alle Einstellungen** vorgenommen haben, können sie mit der **Zurück Taste**  in das **zuletzt aufgerufene Menü** zurückkehren, oder mit der **Home Taste**  direkt auf den **Startbildschirm** wechseln. Ihre **getätigten Eingaben** werden **automatisch gespeichert**.

Einstellungsübersicht der wichtigsten Einstellungen

Drahtlos & Netzwerke	WLAN	Nehmen Sie hier Ihre WLAN-Einstellungen vor.
	Mehr	Hier können Sie weitere Netzwerkeinstellungen vornehmen.
Gerät	Töne	Stellen Sie hier die gewünschte Lautstärke und den gewünschten Benachrichtigungston ein. Weiterhin können Sie einen Bestätigungston bei Berührung des Touchscreens und einen Hinweiston beim Entsperren der Displaysperre aktivieren bzw. deaktivieren.
	Display	Helligkeit – Displayhelligkeit anpassen. Hintergrund – Auswahl des gewünschten Hintergrundes. Ruhezustand – Verzögerung vor der automatischen Displayabschaltung anpassen. Schriftgröße – Einstellen der gewünschten Schriftgröße.
	Speicher	Hier bekommen Sie Informationen über den internen Speicher und - falls eingesetzt - über Ihre MicroSD-Karte. Weiterhin können Sie den Inhalt des Speichers löschen.
	Akku	Hier bekommen Sie Informationen über den Ladezustand des eingebauten Akkus.
	Apps	Hier können Sie Ihre installierten Anwendungen verwalten und Informationen über die Anwendungen erhalten.
Nutzer	Standortdienste	Hier können Sie diversen Android™ Anwendungen erlauben, Ihren aktuellen Standort über Drahtlosnetzwerke festzustellen und zu nutzen (z.B. Google Maps™). Sie können weiterhin festlegen, ob Google™ Suchergebnisse und andere Dienste an Ihren Standort anpassen darf.
	Sicherheit	Hier können Sie beispielsweise eine Bildschirmsperre einrichten und weitere sicherheitsrelevante Einstellungen vornehmen.
	Sprache & Eingabe	Hier können Sie beispielsweise Ihre bevorzugte Sprache einstellen, dem persönlichen Wörterbuch verschiedene Wörter hinzufügen und diverse Einstellungen an der Tastatur vornehmen.
	Sichern & Zurücksetzen	Hier können Sie Ihre SystemEinstellungen und Anwendungsdaten auf Google™-Servern sichern. Des Weiteren können Sie die Werkseinstellungen wiederherstellen. <u>ACHTUNG</u> : Dazu werden alle auf dem Gerät gespeicherten Daten gelöscht.
Konten	Konto hinzufügen	Hier können Sie verschiedene Konten hinzufügen.
System	Datum & Uhrzeit	Hier können Sie das Datum, die Uhrzeit, die Zeitzone und das Anzeigeformat festlegen.
	Über das Tablet	Zeigt Ihnen Informationen über das Gerät.

15.) Verwaltung von Anwendungen

Vorinstallierte Anwendungen

Dieses Gerät wird mit bereits **vorinstallierten Anwendungen** ausgeliefert. Eine **Übersicht** der bereits installierten **Anwendungen** finden Sie in der **Anwendungsübersicht** . Um eine dieser **Anwendungen** zu **öffnen**, tippen Sie **kurz** auf das **zugehörige Icon**.

Installation von Anwendungen

Um **Anwendungen** auf dem Gerät zu **installieren**, führen Sie bitte die **folgenden Schritte** aus:

- (1) Öffnen Sie die gewünschte Quelle für den Download von Anwendungen, beispielsweise den **Google Playstore™**. Hierzu müssen Sie sich zuerst mit Ihrem **bestehenden Playstore™ Konto** anmelden, oder ein **neues Playstore™ Konto** einrichten. Folgen Sie dazu einfach den **Anweisungen** auf dem Bildschirm.
- (2) Nach **erfolgreicher Anmeldung** steht Ihnen nun die große **Anwendungsauswahl** des **Google Playstore™** zur Verfügung. Wählen Sie die **gewünschte Anwendung** aus, tippen Sie auf **Installieren** und **bestätigen** Sie gegebenenfalls die **Zugriffsberechtigungen** der Anwendung. Der **Download** startet nun und der **Fortschritt** wird Ihnen in der oberen linken **Statusbar** angezeigt.
- (3) Nach dem **Download** der Anwendung wird diese nun automatisch **installiert**. Sie finden die neue **Anwendung** nach erfolgreicher Installation im **Anwendungsmenü**. Den **Installationsfortschritt** finden Sie in der oberen linken **Statusbar**.

Deinstallation von Anwendungen





- (1) Öffnen Sie bitte die **System Einstellungen** durch kurzes Tippen auf das **Einstellungen Icon** in der Anwendungsübersicht.
- (2) Tippen Sie jetzt kurz auf den Menüpunkt "**Apps**", um in die **Anwendungseinstellungen** zu gelangen.
- (3) Wählen Sie zwischen den Menüoberpunkten "**Heruntergeladen, Speicher, Aktiv und Alle**" die gewünschte Anwendungsübersicht durch kurzes **Tippen** aus.
- (4) Wählen Sie als nächstes durch **kurzes Tippen** die **Anwendung** aus, die Sie **deinstallieren** möchten.
- (5) Tippen Sie nun auf "**Deinstallieren**" und **bestätigen** Sie Ihre Eingabe mit **OK**, um die **Anwendung** vom **Gerät** zu deinstallieren.

Hinweis: Sie können vorinstallierte Software nicht löschen.

16.) Datei Explorer

Öffnen Sie die **Anwendungsübersicht** und tippen Sie anschließend kurz auf das **Explorer Icon**, um den **Datei Explorer** zu starten.

Durch Dateien und Ordner navigieren

- Ihnen stehen der **interne Speicher** (Internal Memory), die **Speicherkarte** (SD Card) und **USB** zur Auswahl. Tippen Sie auf den **gewünschten Speicherort**, um die **darauf enthaltenen Dateien** als **Liste** angezeigt zu bekommen. Sollte **keine Speicherkarte** eingesetzt, oder **kein Speichermedium** über den **USB Anschluss verbunden** sein, wird Ihnen dies mit „... **is unmounted**“ mitgeteilt.
- Mit einer **vertikalen Wischbewegung** können Sie nun durch Ihre Dateien und Ordner **scrollen**. Öffnen Sie eine **Datei** oder einen **Ordner** durch **kurzes Tippen**.
- Sie können einen **Schritt Vor-**  oder **Zurückwechseln**  indem Sie die entsprechenden **Icons** kurz antippen.
- Um in der **Dateistruktur** eine **Ebene höher** zu kommen, tippen Sie **kurz** auf das **LevelUp Icon** .
- Mit dem **Home Icon**  wechseln Sie **direkt** in das **Hauptverzeichnis**.



Die Toolbar nutzen



Tippen auf die **Menü Taste**  und dort auf „Hide Toolbar“, um die **Toolbar** aus- und einzublenden

Home	Direkt in das Hauptverzeichnis wechseln.
LevelUp	Eine Ebene höher wechseln.
Multi	Mehrere Dateien auswählen.
Editor	Kopieren, löschen, verschieben, einfügen oder umbenennen einer Datei oder eines Ordners.
New Folder	Legen Sie ein neues Verzeichnis an.
Back	Einen Schritt zurück.
Next	Einen Schritt vorwärts.

Dateien und Ordner kopieren, verschieben und umbenennen

- 1.) **Navigieren** Sie zu der **gewünschten Datei** in der **Dateiübersicht**.
- 2.) Tippen und **halten** Sie den Finger **auf der Datei**, bis ein **Infocfeld** erscheint.
- 3.) Wählen Sie nun die gewünschte **Funktion** aus. Sie haben die Wahl zwischen **Kopieren** (Copy), **Löschen** (Delete), **Verschieben** (Move), **Einfügen** (Paste) – hierfür muss sich eine Datei in der **Zwischenablage** befinden - und **Umbenennen** (Rename).
- 4.) Zum **kopieren** oder **verschieben** tippen Sie kurz auf das **entsprechende Icon** (Copy / Move) und **navigieren** Sie anschließend in das **Zielverzeichnis**. Tippen Sie **anschließend** auf das **Editor Icon**  und wählen Sie durch **kurzes Tippen** „Paste“, um die **Datei einzufügen**.
- 5.) Um eine **Datei** zu **löschen** tippen Sie auf „Delete“ und **bestätigen** Sie zur **Sicherheit** nochmals mit „Delete“. Zum **Abbrechen** tippen Sie **kurz** auf „Cancel“.
- 6.) Zum **Umbenennen** einer **Datei** tippen Sie auf „Rename“ und geben Sie **anschließend** über die **virtuelle Tastatur** den **neuen Dateinamen** ein. **Bestätigen** Sie Ihre **Eingabe** mit „OK“ oder brechen Sie den **Vorgang** mit „Cancel“ ab.
- 7.) Sie können **mehrere Dateien** und **Ordner gleichzeitig kopieren, löschen** oder **verschieben**. Tippen Sie dazu auf das **Multi Icon**  und **anschließend** auf die **gewünschten Dateien**. Die **markierten Dateien** werden nun in einer **anderen Farbe** angezeigt. Tippen Sie auf das **Editor Icon** , um die gewünschte **Aktion** durchzuführen.

17.) Eingeschränkte Garantiebedingungen

Die Garantie deckt nur den Ersatz dieses Intenso Produkts ab. Die Garantie gilt nicht für normale Verschleißerscheinungen, die sich aus fehlerhaftem, unsachgemäßem Gebrauch, Nachlässigkeit, Unfall, Inkompatibilität, oder aus mangelhafter Leistung einer bestimmten Computer Hardware oder Computer Software ergeben.

Es besteht kein Garantieanspruch bei Nichteinhaltung der Intenso Bedienungsanleitung sowie bei unsachgemäßer Montage, Gebrauch oder bei Defekten durch andere Geräte.

Wird das Produkt Erschütterungen, elektrostatischer Entladungen, Wärme- oder Feuchtigkeitseinwirkungen jenseits der Produktspezifikationen ausgesetzt, besteht kein Garantieanspruch.

Intenso haftet nicht für Datenverluste oder jegliche, auftretende Begleitschäden oder Folgeschäden, für die Verletzung der Garantiebedingungen oder für sonstige Schäden, gleich welche Ursache zugrunde liegt.

Dieses Produkt ist nicht für eine kommerzielle Nutzung oder für medizinische und spezielle Anwendungen vorgesehen, in denen der Ausfall des Produktes Verletzungen, Todesfälle oder erhebliche Sachschäden verursachen kann.

18.) Technische Daten

CPU	1.0 GHz Dualcore based on Cortex A9
Arbeitsspeicher	1 GB DDR 3
Betriebssystem	Android 4.2.2
Kompatible Betriebssysteme	Windows XP / Vista / 7 / 8 / Linux 2,4 und höher / Mac 10.6 und höher
Anschlussmöglichkeiten	Kopfhörer, Micro SD (SDHC/SDXC), micro USB
WLAN	WiFi (802.11 b/g/n)
G-Sensor	360 Grad Rotation
Photo Format	JPEG, BMP, GIF, PNG
Audio Format	MP3, WMA, WAV, OGG, FLAC, APE
Video Format	MPEG1, MPEG 4, FLV
Display	TFT LCD Display, 1024 x 600 Pixel
Kamera	0,3 MP Front Kamera
SNR	>= 80 dB
Frequenzbereich	20 Hz – 20 KHz
Netzteil	(V) AC Adapter (HUONIO HNBC050120UE): AC Input 100-240V~50/60Hz, DC Output 5V / 1.2A
Interne Batterie	Wiederaufladbarer Lithium-Ionen Polymer Akku

19.) Wartung des Gerätes

Sprühen oder Tragen Sie niemals eine Flüssigkeit direkt auf das Display oder Gehäuse auf.

20.) Säuberung des Gerätes

Wischen Sie Gehäuse, Rahmen und Display vorsichtig mit einem weichen, fusself- und chemikalienfreien Tuch ab. Verwenden Sie nur Reinigungsmittel, die speziell für Displays bestimmt sind.

21.) Entsorgung von Elektro-Altgeräten

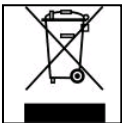

Die mit diesem Symbol gekennzeichneten Geräte unterliegen der europäischen Richtlinie 2002/96/EC. Alle Elektro- und Elektroaltgeräte müssen getrennt vom Hausmüll über die dafür vorgesehenen staatlichen Stellen entsorgt werden. Mit der ordnungsgemäßen Entsorgung von Elektro-Altgeräten vermeiden Sie Umweltschäden.

(Intenso)[®]

49377 Vechta
Germany
www.intenso.de



22.) Lizenzinformation

HINWEIS!

Sehr geehrte Kundin, sehr geehrter Kunde,
bei Interesse können Sie und jeder Dritte den Quelltext der verwendeten GPL/LGPL von der Intenso Homepage <http://www.intenso.de> herunterladen. Der Quelltext des gesuchten Produkts ist für jeden zugänglich über Auswahl der gültigen Produktkategorie und des gewünschten Gerätes. In den Produktdetails finden Sie den Menüpunkt „Treiber“. Öffnen Sie dieses Menü, um den zugehörigen GPL/LGPL Quelltext herunterzuladen. Gegen eine Kostenpauschale von 15 € ist es ebenfalls möglich diesen Quelltext per Postzustellung zu erhalten.
Gerne können Sie uns auch telefonisch zu dem Thema erreichen unter der kostenpflichtigen Rufnummer 0900-1504030 (0,39€/Minute aus dem deutschen Festnetz. Mobilfunkpreise können abweichen.) oder per Mail an support@intenso.de
Weitere Informationen über die GPL/LGPL-Lizenzen finden Sie unter www.gnu.org

GNU GENERAL PUBLIC LICENSE

Version 2, June 1991

Copyright (C) 1989, 1991 Free Software Foundation, Inc.

51 Franklin Street, Fifth Floor, Boston, MA 02110-1301, USA

Everyone is permitted to copy and distribute verbatim copies of this license document, but changing it is not allowed.

Preamble

The licenses for most software are designed to take away your freedom to share and change it. By contrast, the GNU General Public License is intended to guarantee your freedom to share and change free software--to make sure the software is free for all its users. This General Public License applies to most of the Free Software Foundation's software and to any other program whose authors commit to using it. (Some other Free Software Foundation software is covered by the GNU Lesser General Public License instead.) You can apply it to your programs, too.

When we speak of free software, we are referring to freedom, not price. Our General Public Licenses are designed to make sure that you have the freedom to distribute copies of free software (and charge for this service if you wish), that you receive source code or can get it if you want it, that you can change the software or use pieces of it in new free programs; and that you know you can do these things.

To protect your rights, we need to make restrictions that forbid anyone to deny you these rights or to ask you to surrender the rights. These restrictions translate to certain responsibilities for you if you distribute copies of the software, or if you modify it.

For example, if you distribute copies of such a program, whether gratis or for a fee, you must give the recipients all the rights that you have. You must make sure that they, too, receive or can get the source code. And you must show them these terms so they know their rights.

We protect your rights with two steps: (1) copyright the software, and (2) offer you this license which gives you legal permission to copy, distribute and/or modify the software.

Also, for each author's protection and ours, we want to make certain that everyone understands that there is no warranty for this free software. If the software is modified by someone else and passed on, we want its recipients to know that what they have is not the original, so that any problems introduced by others will not reflect on the original authors' reputations.

Finally, any free program is threatened constantly by software patents. We wish to avoid the danger that redistributors of a free program will individually obtain patent licenses, in effect making the program proprietary. To prevent this, we have made it clear that any patent must be licensed for everyone's free use or not licensed at all.

The precise terms and conditions for copying, distribution and modification follow.

TERMS AND CONDITIONS FOR COPYING, DISTRIBUTION AND MODIFICATION

0. This License applies to any program or other work which contains a notice placed by the copyright holder saying it may be distributed under the terms of this General Public License. The "Program", below, refers to any such program or work, and a "work based on the Program" means either the Program or any derivative work under copyright law: that is to say, a work containing the Program or a portion of it, either verbatim or with modifications and/or translated into another language. (Hereinafter, translation is included without limitation in the term "modification".) Each licensee is addressed as "you".

Activities other than copying, distribution and modification are not covered by this License; they are outside

its scope. The act of running the Program is not restricted, and the output from the Program is covered only if its contents constitute a work based on the Program (independent of having been made by running the Program). Whether that is true depends on what the Program does.

1. You may copy and distribute verbatim copies of the Program's source code as you receive it, in any medium, provided that you conspicuously and appropriately publish on each copy an appropriate copyright notice and disclaimer of warranty; keep intact all the notices that refer to this License and to the absence of any warranty; and give any other recipients of the Program a copy of this License along with the Program. You may charge a fee for the physical act of transferring a copy, and you may at your option offer warranty protection in exchange for a fee.

2. You may modify your copy or copies of the Program or any portion of it, thus forming a work based on the Program, and copy and distribute such modifications or work under the terms of Section 1 above, provided that you also meet all of these conditions:

a) You must cause the modified files to carry prominent notices stating that you changed the files and the date of any change.

b) You must cause any work that you distribute or publish, that in whole or in part contains or is derived from the Program or any part thereof, to be licensed as a whole at no charge to all third parties under the terms of this License.

c) If the modified program normally reads commands interactively when run, you must cause it, when started running for such interactive use in the most ordinary way, to print or display an announcement including an appropriate copyright notice and a notice that there is no warranty (or else, saying that you provide a warranty) and that users may redistribute the program under these conditions, and telling the user how to view a copy of this License. (Exception: if the Program itself is interactive but does not normally print such an announcement, your work based on the Program is not required to print an announcement.)

These requirements apply to the modified work as a whole. If identifiable sections of that work are not derived from the Program, and can be reasonably considered independent and separate works in themselves, then this License, and its terms, do not apply to those sections when you distribute them as separate works. But when you distribute the same sections as part of a whole which is a work based on the Program, the distribution of the whole must be on the terms of this License, whose permissions for other licensees extend to the entire whole, and thus to each and every part regardless of who wrote it.

Thus, it is not the intent of this section to claim rights or contest your rights to work written entirely by you; rather, the intent is to exercise the right to control the distribution of derivative or collective works based on the Program.

In addition, mere aggregation of another work not based on the Program with the Program (or with a work based on the Program) on a volume of a storage or distribution medium does not bring the other work under the scope of this License.

3. You may copy and distribute the Program (or a work based on it, under Section 2) in object code or executable form under the terms of Sections 1 and 2 above provided that you also do one of the following:

a) Accompany it with the complete corresponding machine-readable source code, which must be distributed under the terms of Sections 1 and 2 above on a medium customarily used for software interchange; or,

b) Accompany it with a written offer, valid for at least three years, to give any third party, for a charge no more than your cost of physically performing source distribution, a complete machine-readable copy of the corresponding source code, to be distributed under the terms of Sections 1 and 2 above on a medium customarily used for software interchange; or,

c) Accompany it with the information you received as to the offer to distribute corresponding source code.

(This alternative is allowed only for noncommercial distribution and only if you received the program in object code or executable form with such an offer, in accord with Subsection b above.)

The source code for a work means the preferred form of the work for making modifications to it. For an executable work, complete source code means all the source code for all modules it contains, plus any associated interface definition files, plus the scripts used to control compilation and installation of the executable. However, as a special exception, the source code distributed need not include anything that is normally distributed (in either source or binary form) with the major components (compiler, kernel, and so on) of the operating system on which the executable runs, unless that component itself accompanies the executable.

If distribution of executable or object code is made by offering access to copy from a designated place, then offering equivalent access to copy the source code from the same place counts as distribution of the source code, even though third parties are not compelled to copy the source along with the object code.

4. You may not copy, modify, sublicense, or distribute the Program except as expressly provided under this License. Any attempt otherwise to copy, modify, sublicense or distribute the Program is void, and will automatically terminate your rights under this License. However, parties who have received copies, or rights,

from you under this License will not have their licenses terminated so long as such parties remain in full compliance.

5. You are not required to accept this License, since you have not signed it. However, nothing else grants you permission to modify or distribute the Program or its derivative works. These actions are prohibited by law if you do not accept this License. Therefore, by modifying or distributing the Program (or any work based on the Program), you indicate your acceptance of this License to do so, and all its terms and conditions for copying, distributing or modifying the Program or works based on it.

6. Each time you redistribute the Program (or any work based on the Program), the recipient automatically receives a license from the original licensor to copy, distribute or modify the Program subject to these terms and conditions. You may not impose any further restrictions on the recipients' exercise of the rights granted herein. You are not responsible for enforcing compliance by third parties to this License.

7. If, as a consequence of a court judgment or allegation of patent infringement or for any other reason (not limited to patent issues), conditions are imposed on you (whether by court order, agreement or otherwise) that contradict the conditions of this License, they do not excuse you from the conditions of this License. If you cannot distribute so as to satisfy simultaneously your obligations under this License and any other pertinent obligations, then as a consequence you may not distribute the Program at all. For example, if a patent license would not permit royalty-free redistribution of the Program by all those who receive copies directly or indirectly through you, then the only way you could satisfy both it and this License would be to refrain entirely from distribution of the Program.

If any portion of this section is held invalid or unenforceable under any particular circumstance, the balance of the section is intended to apply and the section as a whole is intended to apply in other circumstances. It is not the purpose of this section to induce you to infringe any patents or other property right claims or to contest validity of any such claims; this section has the sole purpose of protecting the integrity of the free software distribution system, which is implemented by public license practices. Many people have made generous contributions to the wide range of software distributed through that system in reliance on consistent application of that system; it is up to the author/donor to decide if he or she is willing to distribute software through any other system and a licensee cannot impose that choice.

This section is intended to make thoroughly clear what is believed to be a consequence of the rest of this License.

8. If the distribution and/or use of the Program is restricted in certain countries either by patents or by copyrighted interfaces, the original copyright holder who places the Program under this License may add an explicit geographical distribution limitation excluding those countries, so that distribution is permitted only in or among countries not thus excluded. In such case, this License incorporates the limitation as if written in the body of this License.

9. The Free Software Foundation may publish revised and/or new versions of the General Public License from time to time. Such new versions will be similar in spirit to the present version, but may differ in detail to address new problems or concerns.

Each version is given a distinguishing version number. If the Program specifies a version number of this License which applies to it and "any later version", you have the option of following the terms and conditions either of that version or of any later version published by the Free Software Foundation. If the Program does not specify a version number of this License, you may choose any version ever published by the Free Software Foundation.

10. If you wish to incorporate parts of the Program into other free programs whose distribution conditions are different, write to the author to ask for permission. For software which is copyrighted by the Free Software Foundation, write to the Free Software Foundation; we sometimes make exceptions for this. Our decision will be guided by the two goals of preserving the free status of all derivatives of our free software and of promoting the sharing and reuse of software generally.

NO WARRANTY

11. BECAUSE THE PROGRAM IS LICENSED FREE OF CHARGE, THERE IS NO WARRANTY FOR THE PROGRAM, TO THE EXTENT PERMITTED BY APPLICABLE LAW. EXCEPT WHEN OTHERWISE STATED IN WRITING THE COPYRIGHT HOLDERS AND/OR OTHER PARTIES PROVIDE THE PROGRAM "AS IS" WITHOUT WARRANTY OF ANY KIND, EITHER EXPRESSED OR IMPLIED, INCLUDING, BUT NOT LIMITED TO, THE IMPLIED WARRANTIES OF MERCHANTABILITY AND FITNESS FOR A PARTICULAR PURPOSE. THE ENTIRE RISK AS TO THE QUALITY AND PERFORMANCE OF THE PROGRAM IS WITH YOU. SHOULD THE PROGRAM PROVE DEFECTIVE, YOU ASSUME THE COST OF ALL NECESSARY SERVICING, REPAIR OR CORRECTION.

12. IN NO EVENT UNLESS REQUIRED BY APPLICABLE LAW OR AGREED TO IN WRITING WILL ANY COPYRIGHT HOLDER, OR ANY OTHER PARTY WHO MAY MODIFY AND/OR REDISTRIBUTE THE PROGRAM AS PERMITTED ABOVE, BE LIABLE TO YOU FOR DAMAGES, INCLUDING ANY GENERAL,

SPECIAL, INCIDENTAL OR CONSEQUENTIAL DAMAGES ARISING OUT OF THE USE OR INABILITY TO USE THE PROGRAM (INCLUDING BUT NOT LIMITED TO LOSS OF DATA OR DATA BEING RENDERED INACCURATE OR LOSSES SUSTAINED BY YOU OR THIRD PARTIES OR A FAILURE OF THE PROGRAM TO OPERATE WITH ANY OTHER PROGRAMS), EVEN IF SUCH HOLDER OR OTHER PARTY HAS BEEN ADVISED OF THE POSSIBILITY OF SUCH DAMAGES.

END OF TERMS AND CONDITIONS

How to Apply These Terms to Your New Programs

If you develop a new program, and you want it to be of the greatest possible use to the public, the best way to achieve this is to make it free software which everyone can redistribute and change under these terms. To do so, attach the following notices to the program. It is safest to attach them to the start of each source file to most effectively convey the exclusion of warranty; and each file should have at least the "copyright" line and a pointer to where the full notice is found.

one line to give the program's name and an idea of what it does.

Copyright (C) yyyy name of author

This program is free software; you can redistribute it and/or modify it under the terms of the GNU General Public License as published by the Free Software Foundation; either version 2 of the License, or (at your option) any later version.

This program is distributed in the hope that it will be useful, but WITHOUT ANY WARRANTY; without even the implied warranty of MERCHANTABILITY or FITNESS FOR A PARTICULAR PURPOSE. See the GNU General Public License for more details.

You should have received a copy of the GNU General Public License along with this program; if not, write to the Free Software Foundation, Inc., 51 Franklin Street, Fifth Floor, Boston, MA 02110-1301, USA.

Also add information on how to contact you by electronic and paper mail.

If the program is interactive, make it output a short notice like this when it starts in an interactive mode:

*Gnomovision version 69, Copyright (C) year name of author
Gnomovision comes with ABSOLUTELY NO WARRANTY; for details
type `show w'. This is free software, and you are welcome
to redistribute it under certain conditions; type `show c'
for details.*

The hypothetical commands `show w' and `show c' should show the appropriate parts of the General Public License. Of course, the commands you use may be called something other than `show w' and `show c'; they could even be mouse-clicks or menu items--whatever suits your program.

You should also get your employer (if you work as a programmer) or your school, if any, to sign a "copyright disclaimer" for the program, if necessary. Here is a sample; alter the names:

*Yoyodyne, Inc., hereby disclaims all copyright
interest in the program `Gnomovision'
(which makes passes at compilers) written
by James Hacker.*

signature of Ty Coon, 1 April 1989

Ty Coon, President of Vice

EG Konformitätserklärung

Wir, die Intenso GmbH,
mit Sitz in der Diepholzerstr. 15 in 49377 Vechta, Deutschland

erklären auf eigene Verantwortung, dass das Produkt:

Modell: 7" Intenso TAB 734 (Artikel Nr. 5509854)
Beschreibung: Tablet-Computer

auf das sich diese Erklärung bezieht, mit den folgenden Richtlinien und Normen konform ist:

R&TTE Richtlinie 1999/5/EG

- EN 301 489-1 V1.9.2
- EN 301 489-17 V2.1.1
- EN 300 328 V1.7.1 : 2006-10
- EN 55022:2010 (Class B)
- EN 55024:2010
- EN 61000-3-2:2006+A1 :2009+A2 :2009 (Class D)
- EN 61000-3-3:2008

Niederspannungsrichtlinie 2006/95/EG

- EN 60950-1:2006+A11:2009+A1:2010+A12:2011+A12:Berichtigung 2012

Öko-Design Richtlinie 2009/125/EG

- 1275/2008
- 278/2009

ROHS Richtlinie 2011/65/EU

Die auf das oben angeführte Gerät bezogenen technischen Unterlagen sind an folgender Stelle hinterlegt:

Intenso GmbH
Diepholzerstr. 15, 49377 Vechta, Deutschland

Autorisierte Person:

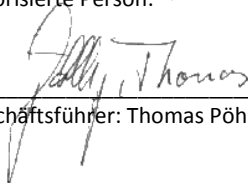

Geschäftsführer: Thomas Pöhlking

Instruction manual TAB 734

Thank you for choosing the **TAB734**. Please follow these instructions in order to be informed about the key functions of the device.



1.) Contents

1.) Contents	1
2.) Notes	2
3.) Device overview.....	4
4.) Package contents	4
5.) Charging the battery	5
6.) Using a Micro SD/SDHC/SDXC Card	5
7.) Transfer of Data between Device and Computer.....	5
8.) Touchscreen	6
9.) WIFI	6
Automatic connection.....	6
Manual connection.....	7
10.) The Home Screen.....	8
View	8
Unlocking the screen	8
Status bar	9
Adjusting the main screen.....	10
Using several home screens.....	10
Pre-installed applications and widgets on the home screen	11
11.) Applications overview	11
<i>Applications overview</i>	11
12.) Sending / Receiving E-Mails.....	12
Setting up your e-mail box	12
Managing email accounts	13
Viewing e-mail messages	13
Writing email messages.....	13
13.) Web browser	14
Using the virtual keyboard	14
Special character input	14
Using the web browser	15
14.) System settings	15
15.) Managing Applications.....	17
Installing applications.....	17
Uninstalling applications	17
16.) File Explorer	18
Navigating through files and folders.....	18
Using the toolbar.....	18
Copy, move and rename files and folders.....	18
17.) Limited Warranty Terms	19
18.) Technical Data.....	19
19.) Maintenance of the Device	20
20.) Cleaning the Device.....	20
21.) Disposal of Used Electronic Equipment.....	20
22.) Licenceinformation about GNU/LGPL.....	21
EC Declaration of Conformity.....	25

This manual may not contain all the features of your device. For the use of third-party applications, please contact the respective manufacturer. Please note that all details can be modified without previous announcement. Current information can be found at www.intenso.de.

Trademarks

Google™, the Google™ logo and Android™ are trademarks of Google Inc. All other product or service names are the property of their respective owners.

2.) Notes

- Avoid hard impacts to the device. Do not place it on inclined surfaces to prevent the device from falling down.
- Do not use the device in extremely cold, hot, humid or dusty areas; also do not expose to direct sunlight.
- Do not use it on sandy places.
- Do not use it in hazardous environments, such as fuelling pumps at petrol stations.
- Avoid using it on cushions, sofas or other objects that foster heat generation, due to the risk of overheating.
- Perform frequent data backups to avoid potential data loss. We are not liable for any loss of data.
- Do not disconnect when data is being transferred or the device formatted. This can cause data loss.
- Images and movies can be protected by third-party rights. Playing without a license can violate copyrights.
- Avoid use in highly magnetic fields.
- Protect the unit from moisture. Should moisture enter the unit, please turn it off immediately, clean it and dry the unit.
- Please do not use chemical solvents to clean the device. Use only a dry cloth.
- Do not place open flames, such as lighted candles, near or on the device.
- We are not liable for damages caused by malfunctions, data losses, incorrect handling, own repairs to the device or changing of the batteries.
- Should the device not respond to your requests, please restart the device by pressing the reset button on the back of it.
- When not in use, please disconnect the mains adaptor from the power supply.
- The outlet must be near the equipment and easily accessible.
- Only use the AC adapter with grounded outlets with AC 100-240V, 50/60 Hz. If you are not sure about the power supply at installation site, please ask the relevant energy services.
- Use only the included AC adapter and power cord.
- To interrupt the power supply to your unit, unplug the AC adapter from the outlet. Always hold the adapter firmly when disconnecting the power supply. Never pull on the line.
- Do not open the housing of the power adapter. With open housing, there is danger of electrical shock. It contains no user-serviceable parts.
- When not in use, the battery of the device discharges slowly. Prior to reuse it must be recharged.

- Please observe environmentally sound disposal of the device and the battery.
- Please do not disassemble into parts or try to repair it yourself because in these cases the warranty expires.
- Do not use the device in places where the use of mobile devices is prohibited. Do not use the device in the vicinity of other electronic devices because the high-frequency signals can cause interferences.
- Do not use it near a pacemaker, in a hospital or near medical equipment, because the high-frequency signals may cause interferences. Keep a distance of at least 15 cm from a pacemaker. Please contact the manufacturer of these devices to obtain information about joint use.
- If you use earphones or headsets on full blast you could cause a durable damage to your hearing. Please consider that a continuously high volume can cause permanent hearing damage. To avoid an eventual health risk caused by too high volume, we recommend you to use the included headsets.
- For reasons of traffic safety, the device may not be operated by the driver himself while driving.

3.) Device overview

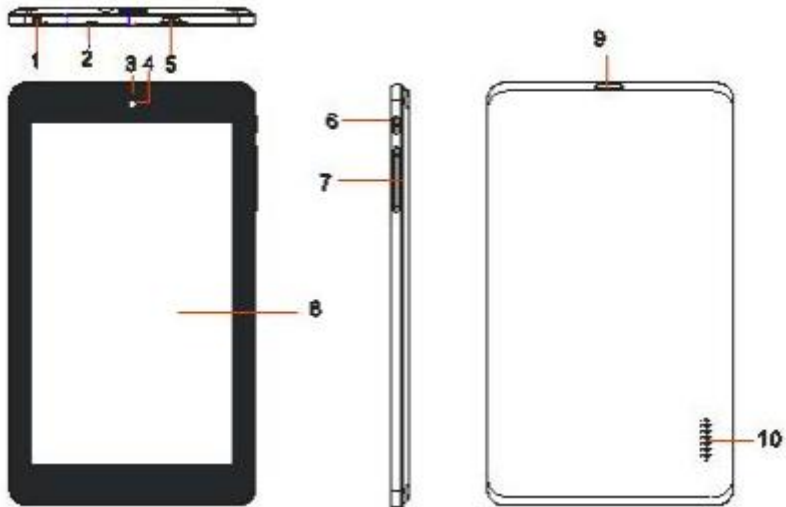

- (1) 3.5mm headphone jack
- (2) Built-in microphone
- (3) Loading Status LED. A red light flashes while loading. A yellow light flashes, as soon as the battery is completely loaded
- (4) Front Camera
- (5) Micro USB Socket

- (6) On / Off button: Press and hold to turn the unit off, press briefly to switch between standby and active mode
- (7) Volume +/-
- (8) Touchscreen
- (9) Micro SD Card slot
- (10) Integrated speaker

4.) Package contents

Please **check** if the **contents are complete**:

- TAB 734
- USB cable
- Power supply 5V 1.2A
- User Manual

5.) Charging the battery

Fully charge the battery of the device **before using it for the first time**. To this end **connect** the supplied **power cable** with the **device** and a **socket**. The **complete charging process** takes about **5 hours**. The **charging status** is displayed at the **front left side** of the device. The **LED** lights up **Red** during the **charging process**, and **changes to Yellow** as soon as the **battery is fully charged**.

Notes

- a. *With 15% remaining residual power of the battery you will get a warning message on the display. To recharge the battery, you should now connect the device using the AC adapter to an electrical outlet to avoid possible data loss and increase the battery life.*
 - b. *You can use the device while charging the battery. To ensure long-lasting battery life, we ask you not to use the device.*
 - c. *To ensure good performance, the built-in battery must be used frequently. If you use the device often, please charge the battery fully at least once a month.*
 - d. *Make sure you use only the included AC adapter for charging.*
-

6.) Using a Micro SD/SDHC/SDXC Card

This device can read data **directly** from a **Micro SD/SDHC/SDXC card** with a **maximum capacity** of **64 GB**. To use a **Micro SD/SDHC/SDXC card**, please insert the card in the designated Micro SD Slot on the **left side of the device**. Use the **pre-installed Explorer** to access the **data** on the **memory card**. To do that, please select the **directory "SD Card"** in the **Explorer**.

7.) Transfer of Data between Device and Computer

- 1.) Connect the **device** using the included **USB cable** to a **computer**.
- 2.) On the device the screen for the **USB connection** is now displayed. Tap briefly "**Turn on USB Storage**". The device is recognized **as a removable disk** and you get the info "**USB memory in use**". After **briefly** tapping the **home button** you can **continue to use** your device **normally**. You have now have access to the **internal memory** of the **device from your computer** and can copy, delete or transfer **files** to your **device**.
- 3.) If an USB connection with the computer exists, the USB icon is displayed in the status bar. You can get additional information in the extended status bar and you can activate or deactivate the USB connection.
 - Select **‘Turn off USB storage’** to **deactivate** the memory.
 - Select the function **‘Remove safely’**  on the computer to **separate the device** from the **computer**.

Note: *The pre-installed applications and the Android™ operating system take up some of the existing internal memory. For this reason, you cannot dispose of the entire internal memory.*

8.) Touchscreen

This device is operated via **touchscreen**. You can easily start **applications** by **tapping** the **touchscreen lightly** with your **fingers**, **enter texts on the virtual keyboard** and switch between **the individual main screens** by **wiping in the respective direction**.



Please **remove** the **protective film from the display** before **using** the device.

The **touchscreen** detects small **electrical charges**, as for example emitted by human fingers, and thus **determines** the **input point**.

Use for **input** ideally your **finger tips**. Operation with a **pen or other sharp objects** is not possible.

The **touchscreen** should **not be exposed** to water or other electrical devices to avoid **malfunctions** and **permanent defects**.

Notes

- a. *If the touchscreen is not operated for two minutes, the device goes into standby mode. Briefly press the on / off button to switch to active mode.*
 - b. *To prevent unwanted input, a lock mode is activated automatically. Please unlock the keypad on the touchscreen by simply dragging the lock icon from the bottom to the top of the screen. The device will now switch to the home screen. Touch the **closed lock**  on the display and keep it **pressed**. Draw the **lock** now to the **open lock**  just appearing on the display and **release** your **finger** from the **display**. The **screen** is now **unlocked**.*
-

You can rotate the device in **all directions**. It has a **sensor** that **directs** the **display automatically**.

9.) WiFi

You need a WLAN connection to connect the device to the internet. Open the WLAN settings in the settings menu to establish it.

Note: Please note that a wireless network must be located within the range of your current location.

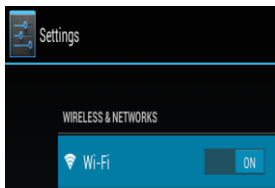

Automatic connection

Open the WLAN settings via the settings menu. Here you can quite simply activate or deactivate the WLAN function. Just slide the virtual switch from the position "On" to the left to deactivate the WLAN function. Now, the display changes to "Off". To reactivate the deactivated WLAN function, just slide the virtual switch to the right.

On the right hand side of the **WiFi settings**, **all available networks** as well as **all already used networks** are shown.

Tap on the **desired network** and, if required, enter the appropriate **WiFi key** (password) to **establish a connection**.

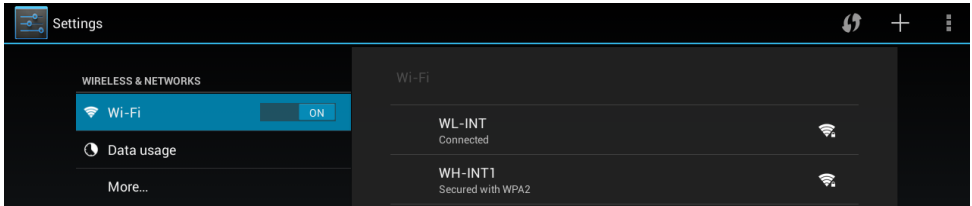

Confirm the entered password, if necessary, by touching the **enter key** and then select **Connect**. After a **short while** you are **connected**.

Notes

- a) If the device goes into standby mode, WiFi is turned off automatically. This reduces power consumption and thus automatically leads to a longer battery life. When the device returns to active mode, the WiFi will automatically re-connect. This may take a few seconds.
 - b) The list of currently searchable WiFi networks will be updated automatically.
 - c) If the WiFi function is enabled, the device automatically connects to an already configured network, provided it is within range.
 - d) If an unknown wireless network is in range, an information box will appear.
-

Manual connection

In order to **search** for an **accessible WiFi network manually**, please proceed as follows:



- (1) Open the **settings**.
- (2) Now open the WLAN settings and tap the three points in the upper right corner and then select "scanning".
- (3) Should the WiFi network **not** appear in the **list of available networks** then **select** the item `Add network` in order to enter the **network SSID**, the **security protocol** and the possibly related **password**. Tap `Save` to **confirm** your **entries**.

10.) The Home Screen

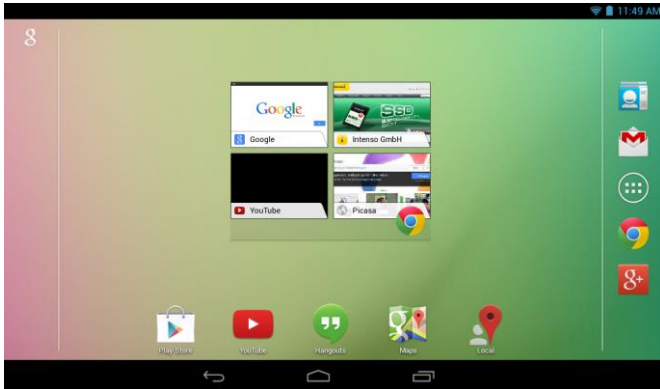
View



Unlocking the screen

If the touchscreen is **not used for two minutes**, the device changes into **standby mode**. Press the **on/off button** for a short time to return to the **active mode**. The locked display is **protecting against undesired input**. Touch the **closed lock**  on the display and keep it **pressed**. Draw the **lock** now to the **open lock**  just appearing on the display and **release** your **finger** from the **display**. The **screen** is now **unlocked**.

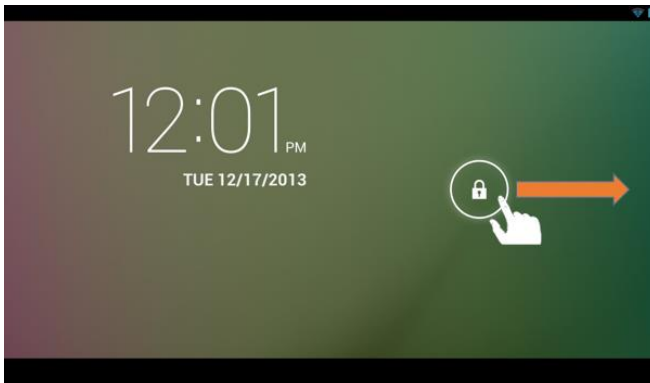

Drag the lock icon with your finger in the direction of the arrow

Advice: Draw the lock symbol to the appearing **camera symbol** to open the **camera application** directly.

Status bar

The **status bars** are located in the **top** and **bottom** area of the **start screen**.

The **top status bar** is divided into **two areas**. If you pull down the bar on the **left side**, then the **current messages** are displayed, if existing.

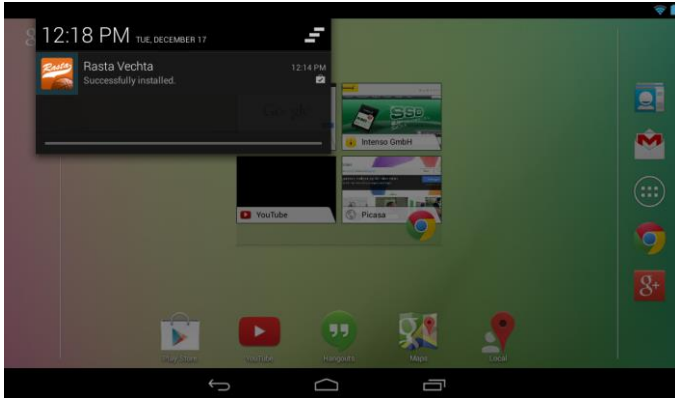

If you pull down the bar on the **right side**, the **quick access fields for various settings** are displayed.

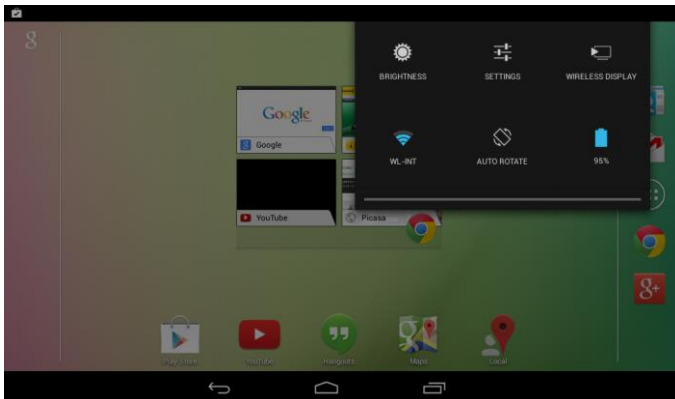

In the **bottom status bar**, you have the option to switch to the **previous display** or to fade out the possible **faded in keyboard**, directly **call up the start screen**, view the **programmes used last** and to **change the volume** of the **device**.



Adjusting the main screen

You can adjust the **main screen** easily to your **individual needs**. If you want to **delete an icon**, tap the **icon** with your **finger** for a **short while** and then **push** it into the displayed **X icon**. Now take your **finger from the touchscreen** and the **icon is deleted**.

If you want to position an **icon from the application overview on the main screen**, tap the icon in the **application overview** for a **short while** and the **main screen** appears. **Move the icon** to the **desired position** and **take your finger from the touchscreen**. The **icon** is now **added** to the main screen. If you move an icon on another icon, a folder containing both icons is automatically created. Tap the folder to view the containing icons and then select the desired icon by tapping it briefly.

You can also add **Widgets** to the **start screen**. To do that, please open the **application overview**. Then you tap the word **Widgets**. All **Widgets available on the device** will now be displayed. **Adding a Widget** to the **start screen** works in the same way as **adding an icon**.

If you want to **change your background image**, just tap a **free place** on the **main screen** and **keep pressing** the display until the **background selection menu** appears.

Using several home screens

Five **main screens that can be individually set-up** are provided. You can easily switch between them by **wiping** the screen **lightly to the left or right**.

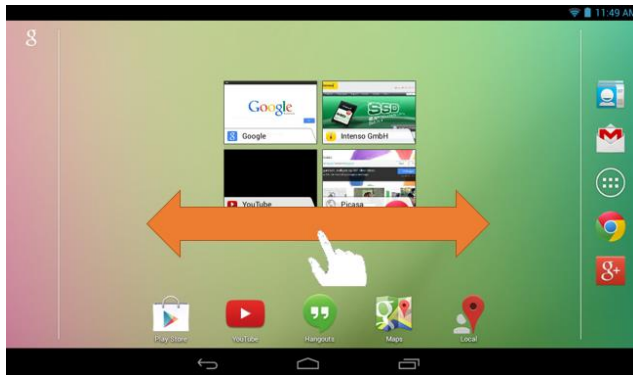

Pressing the home button will always take you automatically back to the middle home screen.

Pre-installed applications and widgets on the home screen

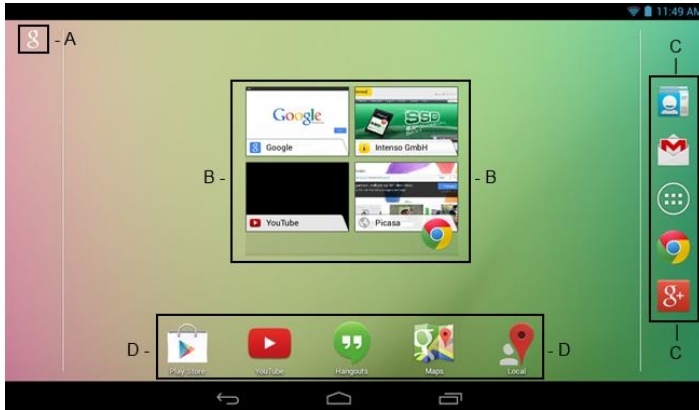

A Link to Google™ search

B Bookmark overview for Chrome™ Browser

C Contacts, Gmail™, Applications overview, Chrome™ and Google+™

D Google Play Store™, YouTube™, Hangouts™, Maps™, and Local™

11.) Applications overview



Tap **briefly** on the **applications overview icon** to **open the applications overview**. You will see a **list of all pre-installed applications** as well as those you have **already installed**. Open the **desired application** by **briefly** tapping the appropriate **icon**.

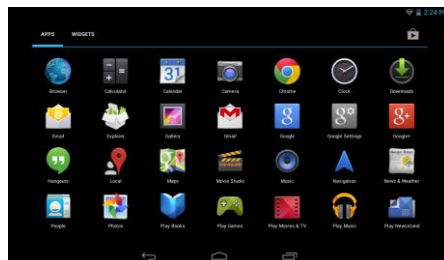

Applications overview

12.) Sending / Receiving E-Mails

An **e-mail application** is pre-installed in this device. You can use your **existing** e-mail address to **send** and **receive** e-mails.

Note: For this function, a wireless Internet connection is required.

Open the application with the **"Email" icon** which is found on the **application menu**.

Setting up your e-mail box

- (1) **Start** the e-mail application by **tapping** on the **Email** icon. You are now prompted to set-up your **e-mail account**.
- (2) Enter your **e-mail address** and the **corresponding password** and then tap **"Next"**. Then **name** your **account** and **fix** the **name** that will be **displayed** on **outgoing messages**. Tap **"Done"** to **complete the set-up**. Your **e-mail mailbox** is selected as the **default mailbox** if you select the option **"Send e-mails from this account by default"**.
- (3) You can set up your **e-mail account manually** as well. Enter your **e-mail address** and **associated password** and then tap on **"Manual Setup"** to enter the **e-mail server information**.
- (4) **Choose** from the **server types POP3, IMAP or Exchange** for **incoming** e-mails.

Note: If you do not know what settings you need to make, please contact your e-mail provider, your network administrator or search terms such as **"POP address"** and **"name of your provider"** for the required information on the Internet.



- (5) Enter the required **information** (server, port, etc.).
- (6) Select the **server type** for **outgoing e-mails** and enter the **required information**.
- (7) Tap **"Next"** to **continue** in the **menu**. The e-mail application **will check** the **server settings** made. After **successful set-up** you will see the message: **"Your account is set up, and email is on its way"**. Your account is now **set up**.
- (8) Enter a **name** for **your mailbox**, then tap **"Done"** to **complete** the process.

Note: If you have more than one email account, each time you start the e-mail application, the default account is called up.

Managing email accounts

Adding a new mailbox:

- (1) Open the **email application** and tap the **menu key**  to display **additional options**. Select the menu item **Settings** and subsequently **Add account** to create a new **mailbox**.
- (2) Follow the instructions of the **Setup Wizard** to **create a new mailbox**.

Deleting a mailbox:

- (1) Open the **email application** and tap the **menu key**  to display **additional options**. Select the menu item **Settings** and subsequently **Delete account** to delete the desired **mailbox**.

Checking the account properties:

- (1) Open the **email application** and tap the **menu key**  to display **additional options** and then select **Settings**. **All already created mailboxes** will now be displayed on the left side of the menu.
- (2) Tap **the desired mailbox** to display the account settings.
- (3) Tap the **Account setting** you wish to change in order to **make the desired entries**.

Viewing e-mail messages

Open the **e-mail application** by **briefly** tapping the **e-mail icon**. The **mailbox you already created** is **displayed**.

- You can **scroll** through your e-mail with a **vertical sweeping motion**.
- Tap **briefly** on a **particular e-mail** to **open** it.
- Tap and **hold your** finger **on a particular e-mail** in order to display **more options** – an **info box** will be displayed. You can now **open, reply, forward** or **delete** the **e-mail**.

Writing email messages

- (1) Tap the **Email icon** in the **top menu bar** of the email overview and a **new window** will open, where you can **write a new email**.
- (2) Now enter the email **address** of the **recipient**, a **subject line** and the **text** into the **designated fields**. You can also add **Cc/Bcc** to send this email to several users.
- (3) Tap **Send** to send the **email**. Tap **Save** to save the **entered email as a draft**. When you tap the **dustbin** icon, the **currently entered email** will be **deleted**.

13.) Web browser

To launch the **web browser**, tap on the **Browser icon**  on the **home screen**.

To open a website, tap on the **upper input field** for the **Internet address**. The **virtual keyboard** now opens and you can enter the **address** of the desired **website**. To open the **website**, tap **"Go"** or tap on the **arrow icon next to the input field**.

Note: Not all networks provide Internet access. Some networks offer access only to other related local computers but not Internet connection.

Using the virtual keyboard

Tap the **box** to open the **virtual keyboard**. You can now **enter text** or **websites**.





- Caps lock (case sensitive)
- Return button
- Calling up the menu for numbers, characters and special character input
- Space bar (no character input)
- Go (confirmation of your input)

Special character input

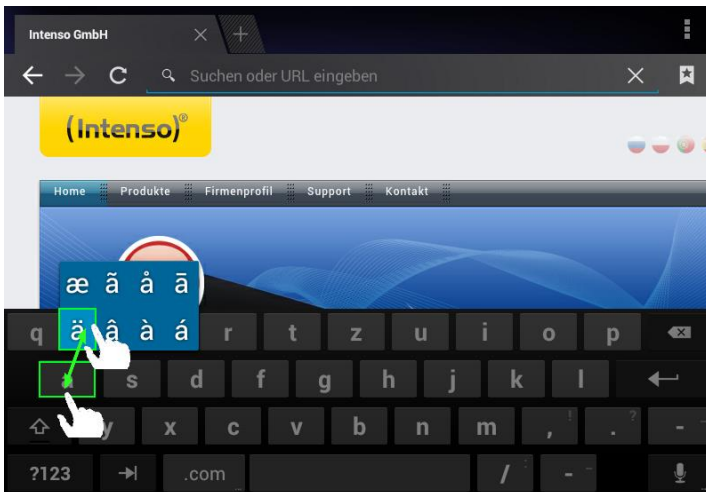
In order to enter a **special character** such as `ä`, tap the `a` **key** with your **finger** for a **long time** to call up the **special character menu**. Now glide with your finger to the desired special character, for example an `ä` and take your finger from the display. You now have entered an `ä`.



Using the web browser

- You can scroll through the **display** by performing a **vertical sweeping motion** with your **finger**. Please do not **start** the sweeping motion on a **menu item** or **link** because otherwise the **existing link** will open.
- To open an **Internet link**, simply tap on the **link**. The new **page** will open **automatically**.
- Press the **menu key**  to open the **web browser menu**. Here **multiple functions** are provided. Among other things you can **refresh the opened website here**, **open a new tab**, **make offline websites readable** or **switch** to the **web browser settings**.
- To **return** to the **previous** page, please press the **back button** .
- To go **directly back to home screen**, press the **home button** .
- To enter a **text**, tap the **appropriate field** and use the **virtual keyboard** for **entering the text**.

Note: For this function, a wireless Internet connection is required.

In **playback mode** you can further adjust your **settings**. Tap **briefly** on the **Menu button** .

Library – a list of all existing music files will be displayed.

Party shuffle – turns on/off Party Shuffle mode.



Add to playlist – adds currently playing title to a playlist.

Delete – deletes the current title.

Sound effects – sets a sound effect to the music playback.

14.) System settings

Tap the **settings icon** in the **application menu** to call up the **system settings**.

- You can find the **individual categories** on the **left side of the menu**. The **available setting options** are displayed by briefly pressing each **selected menu item**. Please note that possibly not all **functions offered** by Android™ are compatible with the device.
- When you have adjusted all **settings** you can return to the **previous menu** with the **Return key** , or switch to the main screen directly with the **Home key** . Your **entries** will be **saved automatically**.

Setting overview of key settings

WiFi & Networks	WiFi	Here you can adjust the WiFi settings.
	More	Here you can adjust additional network settings.
Device	Sounds	Specify the desired volume and sound for messages here. Also you can activate or deactivate a confirmation sound when touching the screen and an indication sound when unlocking the display lock.
	Display	Brightness – Adjust display brightness. Background – Selection of the background. Idle state – Adjust the delay before automatic display deactivation. Font size – set-up of the desired font size.
	Memory	Here you can get information about the internal memory and – if inserted – about your MicroSD card. Also you can delete the memory content.
	Battery	Here you can get information about the state of charge of the integrated batteries.
	Apps	Here you can manage installed applications and get information about them.
User	Location services	Here you can allow multiple Android™ applications to determine and use your current position via WiFi networks (e.g. Google Maps™). You can also determine, if Google™ may adapt search results and other services to your location.
	Security	Here you can set-up a screen lock, for example, or implement other security-relevant settings.
	Language & input	Here you can set your preferred language, for example, or add various words to your personal dictionary or adjust.
	Save & reset	Here you can save your system settings and application data on Google™ servers. Furthermore you can reset the factory settings. CAUTION: In doing so, all data saved on the device will be deleted.
Accounts	Add account	Here you can add different accounts.
System	Date & time	Here you can set the date, time, time zone, and the display format.
	About the Tablet	Shows additional information about the device.

15.) Managing Applications

Pre-installed applications

This device is delivered with **pre-installed applications**. You will find an **overview** of the **applications** already installed in the **application overview** . To **open** one of these **applications**, **tap** on the **corresponding icon**.

Installing applications

To **install applications** on the device, perform the **following steps**:

- (1) Open the **desired source** for **downloading applications**, for example the pre-installed **Google Playstore™**. To do that, you first have to login with your **existing Playstore™ account** or create a **new Playstore™ account**. Just follow the **instructions** on the **screen**.
- (2) After the **successful login**, a large **selection of applications** of the **Google Playstore™** is available to you. Select the **desired application**, tap on **install** and possibly **confirm** the **access authorisation** for this application. The **download** will start now and the **progress** is displayed in the upper left corner of the advanced **status bar**.
- (3) After **downloading** the application, it is automatically **installed**. You can find the new **application** in the **applications menu** after installation was successful. You can see the **installation progress** in the upper left corner of the advanced **status bar**.

Uninstalling applications





- (1) Open the **system settings** by briefly tapping the **settings icon** in the application overview.
- (2) Now tap the menu item **`Apps`** briefly to get to the **application settings**.
- (3) Choose the desired application overview in the menu items **`Download, memory, active and all`** by **tapping it briefly**.
- (4) Now select the **application** you want to deinstall by **tapping it briefly**.
- (5) Now tap **`Deinstall`** and **confirm** your entry with **OK** to deinstall the **application** from the **device**.

Note: You cannot delete pre-installed software.

16.) File Explorer

Open the **applications overview** and then tap briefly on the **Explorer icon** to start the **file explorer**.

Navigating through files and folders

- The **internal memory, memory card (SD Card)** and **USB** are available. Tap the **desired storage location** in order to display the **files contained on** a **list**. If **no memory card** is inserted, or **no storage device is mounted over** the **USB connection**, you will be informed with **"... is unmounted."**
- With a **vertical sweeping motion**, you can now **scroll** through your files and **folders**. Open a **file** or **folder** by **tapping briefly**.
- You can **jump backwards**  or **forwards**  by briefly tapping the **respective icons**.
- To go one **level higher** in the **file structure**, tap on the **LevelUp icon** .
- With the **Home icon**  you can go **directly** to the **main directory**.



Using the toolbar



Tap the **menu key**  and then 'Hide Toolbar' in order to fade the **toolbar** in or out.

Home	Go directly to the main directory.
LevelUp	Go one level higher.
Multi	Select multiple files.
Editor	Copy, move, delete, paste, or rename a file or folder.
New Folder	Create a new folder.
Back	One step back.
Next	One step forward.

Copy, move and rename files and folders

- 1.) **Navigate** to the **desired file** in the **file browser**.
- 2.) Tap and **hold your finger on the file** until an **info box** appears.
- 3.) Now select the desired **function**. You can choose between **Copy, Delete, Move, Paste** – to do so, a file must be in the **clipboard** – and **Rename**.
- 4.) To **copy** or **move**, tap briefly on the **appropriate icon** (Copy/Move) and then **navigate** to the **target directory**. Then tap on the **editor icon**  and select by **briefly tapping "Paste"** to insert the **file**.
- 5.) To **delete** a file, tap **"Delete"** and **confirm** for **safety** again with **"Delete"**. To **cancel**, tap **briefly** the **"Cancel"**.
- 6.) To **rename** a file, tap on **"Rename"** and then enter the **new file name** over the **virtual keyboard**. **Confirm** your **entry** with **"OK"** or cancel the **process** with **"Cancel"**.
- 7.) You can simultaneously **copy, delete** or **move several files** and **folders**. Tap on the **multi icon**  and then tap the **desired files**. The **marked files** are now displayed in a **different colour**. Tap the **editor icon**  to perform the desired **action**.

17.) Limited Warranty Terms

The warranty covers only the replacement of this Intenso product. The warranty does not cover normal wear and tear resulting from faulty, improper use, negligence, accident, incompatibility, or poor performance of specific computer hardware or computer software.

There is no warranty in the case of non-compliance with the Intenso user manual, improper installation, use, or defects caused by other equipment.

Warranty is also excluded if the product is subjected to the effects of vibration, electrostatic discharge, heat or moisture beyond the product specifications.

Intenso is not liable for data loss or any collateral damage, or consequential damages, for breach of warranty or for any other damage, whatever the underlying cause.

This product is not intended for commercial use or for medical and special applications in which the failure of the product may cause injury, death or substantial property damage.

18.) Technical Data

CPU	1.0 GHz Dualcore based on Cortex A9
Main memory	1 GB DDR 3
Operating system	Android 4.2.2
Compatible operating systems	Windows XP / Vista / 7 / 8 / Linux 2.4 and higher / Mac 10.6 and higher
Connection options	Headphone, Micro SD (SDHC/SDHX), micro USB
Wireless	WiFi (802.11 b/g/n)
G-Sensor	360 degree rotation
Photo format	JPEG, BMP, GIF, PNG
Audio format	MP3, WMA, WAV, OGG, FLAC, APE
Video format	MPEG1, MPEG 4, FLV
Display	TFT LCD Display, 1024 x 600 Pixel
Camera	0,3 MP front camera
SNR	>= 80 dB
Frequency range	20 Hz – 20 KHz
Power Supply	(V) AC Adapter (HUONIO HNBC050120UE): AC Input 100-240V~50/60Hz, DC Output 5V / 1.2A
Internal Battery	Rechargeable lithium-ion polymer battery

19.) Maintenance of the Device

Never spray or apply a liquid directly onto the screen or casing.

20.) Cleaning the Device

Wipe the casing, frame and screen gently with a soft, lint-free cloth.
Use only detergents specifically designed for displays.

21.) Disposal of Used Electronic Equipment

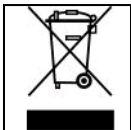

Equipment marked with this symbol is subject to the European Directive 2002/96/EC.

All electrical devices and used electrical equipment must be disposed of separately from household waste over the appropriate government agencies.

Proper disposal of old electronic equipment helps avoid environmental damage.

(Intenso)[®]

49377 Vechta
Germany
www.intenso.de



22.) Licence information about GNU/LGPL

Notice of GNU GENERAL PUBLIC LICENSE and LESSER GENERAL PUBLIC LICENCE

Dear Customer,

If interested, you and any third party can download the source code of used GPL / LGPL from Intenso Webpage <http://www.intenso.de> . The source code of the desired product is available to anyone on the selection of valid product category and the desired device. In the product details you will find the entry "drivers". Open this menu to download the corresponding GPL / LGPL code. For a fee of 35 € (delivery to another country as Germany), it is also possible to obtain this code by postal delivery. More information about the GPL/LGPL-Licence can you find on following website www.gnu.org

GNU GENERAL PUBLIC LICENSE

Version 2, June 1991

Copyright (C) 1989, 1991 Free Software Foundation, Inc.

51 Franklin Street, Fifth Floor, Boston, MA 02110-1301, USA

Everyone is permitted to copy and distribute verbatim copies of this license document, but changing it is not allowed.

Preamble

The licenses for most software are designed to take away your freedom to share and change it. By contrast, the GNU General Public License is intended to guarantee your freedom to share and change free software--to make sure the software is free for all its users. This General Public License applies to most of the Free Software Foundation's software and to any other program whose authors commit to using it. (Some other Free Software Foundation software is covered by the GNU Lesser General Public License instead.) You can apply it to your programs, too.

When we speak of free software, we are referring to freedom, not price. Our General Public Licenses are designed to make sure that you have the freedom to distribute copies of free software (and charge for this service if you wish), that you receive source code or can get it if you want it, that you can change the software or use pieces of it in new free programs; and that you know you can do these things.

To protect your rights, we need to make restrictions that forbid anyone to deny you these rights or to ask you to surrender the rights. These restrictions translate to certain responsibilities for you if you distribute copies of the software, or if you modify it.

For example, if you distribute copies of such a program, whether gratis or for a fee, you must give the recipients all the rights that you have. You must make sure that they, too, receive or can get the source code. And you must show them these terms so they know their rights.

We protect your rights with two steps: (1) copyright the software, and (2) offer you this license which gives you legal permission to copy, distribute and/or modify the software.

Also, for each author's protection and ours, we want to make certain that everyone understands that there is no warranty for this free software. If the software is modified by someone else and passed on, we want its recipients to know that what they have is not the original, so that any problems introduced by others will not reflect on the original authors' reputations.

Finally, any free program is threatened constantly by software patents. We wish to avoid the danger that redistributors of a free program will individually obtain patent licenses, in effect making the program proprietary. To prevent this, we have made it clear that any patent must be licensed for everyone's free use or not licensed at all.

The precise terms and conditions for copying, distribution and modification follow.

TERMS AND CONDITIONS FOR COPYING, DISTRIBUTION AND MODIFICATION

0. This License applies to any program or other work which contains a notice placed by the copyright holder saying it may be distributed under the terms of this General Public License. The "Program", below, refers to any such program or work, and a "work based on the Program" means either the Program or any derivative work under copyright law: that is to say, a work containing the Program or a portion of it, either verbatim or with modifications and/or translated into another language. (Hereinafter, translation is included without limitation in the term "modification".) Each licensee is addressed as "you".

Activities other than copying, distribution and modification are not covered by this License; they are outside its scope. The act of running the Program is not restricted, and the output from the Program is covered only if its contents constitute a work based on the Program (independent of having been made by running the Program). Whether that is true depends on what the Program does.

1. You may copy and distribute verbatim copies of the Program's source code as you receive it, in any

medium, provided that you conspicuously and appropriately publish on each copy an appropriate copyright notice and disclaimer of warranty; keep intact all the notices that refer to this License and to the absence of any warranty; and give any other recipients of the Program a copy of this License along with the Program. You may charge a fee for the physical act of transferring a copy, and you may at your option offer warranty protection in exchange for a fee.

2. You may modify your copy or copies of the Program or any portion of it, thus forming a work based on the Program, and copy and distribute such modifications or work under the terms of Section 1 above, provided that you also meet all of these conditions:

- a) You must cause the modified files to carry prominent notices stating that you changed the files and the date of any change.
 - b) You must cause any work that you distribute or publish, that in whole or in part contains or is derived from the Program or any part thereof, to be licensed as a whole at no charge to all third parties under the terms of this License.
 - c) If the modified program normally reads commands interactively when run, you must cause it, when started running for such interactive use in the most ordinary way, to print or display an announcement including an appropriate copyright notice and a notice that there is no warranty (or else, saying that you provide a warranty) and that users may redistribute the program under these conditions, and telling the user how to view a copy of this License. (Exception: if the Program itself is interactive but does not normally print such an announcement, your work based on the Program is not required to print an announcement.)
- These requirements apply to the modified work as a whole. If identifiable sections of that work are not derived from the Program, and can be reasonably considered independent and separate works in themselves, then this License, and its terms, do not apply to those sections when you distribute them as separate works. But when you distribute the same sections as part of a whole which is a work based on the Program, the distribution of the whole must be on the terms of this License, whose permissions for other licensees extend to the entire whole, and thus to each and every part regardless of who wrote it. Thus, it is not the intent of this section to claim rights or contest your rights to work written entirely by you; rather, the intent is to exercise the right to control the distribution of derivative or collective works based on the Program.

In addition, mere aggregation of another work not based on the Program with the Program (or with a work based on the Program) on a volume of a storage or distribution medium does not bring the other work under the scope of this License.

3. You may copy and distribute the Program (or a work based on it, under Section 2) in object code or executable form under the terms of Sections 1 and 2 above provided that you also do one of the following:

- a) Accompany it with the complete corresponding machine-readable source code, which must be distributed under the terms of Sections 1 and 2 above on a medium customarily used for software interchange; or,
- b) Accompany it with a written offer, valid for at least three years, to give any third party, for a charge no more than your cost of physically performing source distribution, a complete machine-readable copy of the corresponding source code, to be distributed under the terms of Sections 1 and 2 above on a medium customarily used for software interchange; or,
- c) Accompany it with the information you received as to the offer to distribute corresponding source code. (This alternative is allowed only for noncommercial distribution and only if you received the program in object code or executable form with such an offer, in accord with Subsection b above.)

The source code for a work means the preferred form of the work for making modifications to it. For an executable work, complete source code means all the source code for all modules it contains, plus any associated interface definition files, plus the scripts used to control compilation and installation of the executable. However, as a special exception, the source code distributed need not include anything that is normally distributed (in either source or binary form) with the major components (compiler, kernel, and so on) of the operating system on which the executable runs, unless that component itself accompanies the executable.

If distribution of executable or object code is made by offering access to copy from a designated place, then offering equivalent access to copy the source code from the same place counts as distribution of the source code, even though third parties are not compelled to copy the source along with the object code.

4. You may not copy, modify, sublicense, or distribute the Program except as expressly provided under this License. Any attempt otherwise to copy, modify, sublicense or distribute the Program is void, and will automatically terminate your rights under this License. However, parties who have received copies, or rights, from you under this License will not have their licenses terminated so long as such parties remain in full compliance.

5. You are not required to accept this License, since you have not signed it. However, nothing else grants you permission to modify or distribute the Program or its derivative works. These actions are prohibited by

law if you do not accept this License. Therefore, by modifying or distributing the Program (or any work based on the Program), you indicate your acceptance of this License to do so, and all its terms and conditions for copying, distributing or modifying the Program or works based on it.

6. Each time you redistribute the Program (or any work based on the Program), the recipient automatically receives a license from the original licensor to copy, distribute or modify the Program subject to these terms and conditions. You may not impose any further restrictions on the recipients' exercise of the rights granted herein. You are not responsible for enforcing compliance by third parties to this License.

7. If, as a consequence of a court judgment or allegation of patent infringement or for any other reason (not limited to patent issues), conditions are imposed on you (whether by court order, agreement or otherwise) that contradict the conditions of this License, they do not excuse you from the conditions of this License. If you cannot distribute so as to satisfy simultaneously your obligations under this License and any other pertinent obligations, then as a consequence you may not distribute the Program at all. For example, if a patent license would not permit royalty-free redistribution of the Program by all those who receive copies directly or indirectly through you, then the only way you could satisfy both it and this License would be to refrain entirely from distribution of the Program.

If any portion of this section is held invalid or unenforceable under any particular circumstance, the balance of the section is intended to apply and the section as a whole is intended to apply in other circumstances. It is not the purpose of this section to induce you to infringe any patents or other property right claims or to contest validity of any such claims; this section has the sole purpose of protecting the integrity of the free software distribution system, which is implemented by public license practices. Many people have made generous contributions to the wide range of software distributed through that system in reliance on consistent application of that system; it is up to the author/donor to decide if he or she is willing to distribute software through any other system and a licensee cannot impose that choice. This section is intended to make thoroughly clear what is believed to be a consequence of the rest of this License.

8. If the distribution and/or use of the Program is restricted in certain countries either by patents or by copyrighted interfaces, the original copyright holder who places the Program under this License may add an explicit geographical distribution limitation excluding those countries, so that distribution is permitted only in or among countries not thus excluded. In such case, this License incorporates the limitation as if written in the body of this License.

9. The Free Software Foundation may publish revised and/or new versions of the General Public License from time to time. Such new versions will be similar in spirit to the present version, but may differ in detail to address new problems or concerns.

Each version is given a distinguishing version number. If the Program specifies a version number of this License which applies to it and "any later version", you have the option of following the terms and conditions either of that version or of any later version published by the Free Software Foundation. If the Program does not specify a version number of this License, you may choose any version ever published by the Free Software Foundation.

10. If you wish to incorporate parts of the Program into other free programs whose distribution conditions are different, write to the author to ask for permission. For software which is copyrighted by the Free Software Foundation, write to the Free Software Foundation; we sometimes make exceptions for this. Our decision will be guided by the two goals of preserving the free status of all derivatives of our free software and of promoting the sharing and reuse of software generally.

NO WARRANTY

11. BECAUSE THE PROGRAM IS LICENSED FREE OF CHARGE, THERE IS NO WARRANTY FOR THE PROGRAM, TO THE EXTENT PERMITTED BY APPLICABLE LAW. EXCEPT WHEN OTHERWISE STATED IN WRITING THE COPYRIGHT HOLDERS AND/OR OTHER PARTIES PROVIDE THE PROGRAM "AS IS" WITHOUT WARRANTY OF ANY KIND, EITHER EXPRESSED OR IMPLIED, INCLUDING, BUT NOT LIMITED TO, THE IMPLIED WARRANTIES OF MERCHANTABILITY AND FITNESS FOR A PARTICULAR PURPOSE. THE ENTIRE RISK AS TO THE QUALITY AND PERFORMANCE OF THE PROGRAM IS WITH YOU. SHOULD THE PROGRAM PROVE DEFECTIVE, YOU ASSUME THE COST OF ALL NECESSARY SERVICING, REPAIR OR CORRECTION.

12. IN NO EVENT UNLESS REQUIRED BY APPLICABLE LAW OR AGREED TO IN WRITING WILL ANY COPYRIGHT HOLDER, OR ANY OTHER PARTY WHO MAY MODIFY AND/OR REDISTRIBUTE THE PROGRAM AS PERMITTED ABOVE, BE LIABLE TO YOU FOR DAMAGES, INCLUDING ANY GENERAL, SPECIAL, INCIDENTAL OR CONSEQUENTIAL DAMAGES ARISING OUT OF THE USE OR INABILITY TO USE THE PROGRAM (INCLUDING BUT NOT LIMITED TO LOSS OF DATA OR DATA BEING RENDERED INACCURATE OR LOSSES SUSTAINED BY YOU OR THIRD PARTIES OR A FAILURE OF THE PROGRAM TO OPERATE WITH ANY OTHER PROGRAMS), EVEN IF SUCH HOLDER OR OTHER

PARTY HAS BEEN ADVISED OF THE POSSIBILITY OF SUCH DAMAGES.

END OF TERMS AND CONDITIONS

How to Apply These Terms to Your New Programs

If you develop a new program, and you want it to be of the greatest possible use to the public, the best way to achieve this is to make it free software which everyone can redistribute and change under these terms.

To do so, attach the following notices to the program. It is safest to attach them to the start of each source file to most effectively convey the exclusion of warranty; and each file should have at least the "copyright" line and a pointer to where the full notice is found.

one line to give the program's name and an idea of what it does.

Copyright (C) yyyy name of author

This program is free software; you can redistribute it and/or modify it under the terms of the GNU General Public License as published by the Free Software Foundation; either version 2 of the License, or (at your option) any later version.

This program is distributed in the hope that it will be useful, but WITHOUT ANY WARRANTY; without even the implied warranty of MERCHANTABILITY or FITNESS FOR A PARTICULAR PURPOSE. See the GNU General Public License for more details.

You should have received a copy of the GNU General Public License along with this program; if not, write to the Free Software

Foundation, Inc., 51 Franklin Street, Fifth Floor, Boston, MA 02110-1301, USA.

Also add information on how to contact you by electronic and paper mail.

If the program is interactive, make it output a short notice like this when it starts in an interactive mode:

Gnomovision version 69, Copyright (C) year name of author

Gnomovision comes with ABSOLUTELY NO WARRANTY; for details

type `show w'. This is free software, and you are welcome

to redistribute it under certain conditions; type `show c'

for details.

The hypothetical commands `show w' and `show c' should show the appropriate parts of the General Public License. Of course, the commands you use may be called something other than `show w' and `show c'; they could even be mouse-clicks or menu items--whatever suits your program.

You should also get your employer (if you work as a programmer) or your school, if any, to sign a "copyright disclaimer" for the program, if necessary. Here is a sample; alter the names:

Yoyodyne, Inc., hereby disclaims all copyright interest in the program `Gnomovision'

(which makes passes at compilers) written

by James Hacker.

signature of Ty Coon, 1 April 1989

Ty Coon, President of Vice

EC Declaration of Conformity

We, the company Intenso GmbH,
with headquarters located at:
Diepholzerstr. 15 in 49377 Vechta, Germany

Declare under our sole responsibility that the product:

Model: 7" Intenso TAB 734 (item no. 5509854)
Description: Tablet computer

is in conformity with the provisions of the following Council Directives:

Directive R&TTE 1999/5/CE

- EN 301 489-1 V1.9.2
- EN 301 489-17 V2.1.1
- EN 300 328 V1.7.1 : 2006-10
- EN 55022:2010 (Class B)
- EN 55024:2010
- EN 61000-3-2:2006+A1 :2009+A2 :2009 (Class D)
- EN 61000-3-3:2008

Low Voltage Directive 2006/95/EC

- EN 60950-1:2006+A11:2009+A1:2010+A12:2011+A12: correction 2012

Ecodesign Directive 2009/125/EC

- 1275/2008
- 278/2009

ROHS Directive 2011/65/EU

The technical documents related to the device mentioned above have been deposited at:

Intenso GmbH
Diepholzerstr. 15, 49377 Vechta, Germany

Authorized Representative:

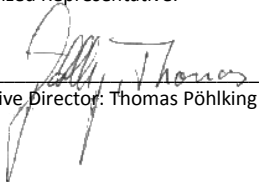
Executive Director: Thomas Pöhlking

Istruzioni per l'uso di TAB 734

Molte grazie per aver scelto il **TAB 734**. La invitiamo a leggere e seguire le presenti istruzioni, che Le forniranno informazioni relativamente alle più importanti funzioni dell'apparecchio.



1.) Indice

1.) Indice	1
2.) Note	2
3.) Quadro generale dell'apparecchio	4
4.) Contenuto della confezione	4
5.) Caricamento della batteria	5
6.) Utilizzo di una scheda Micro SD/SDHC/SDXC	5
7.) Trasmissione di dati tra l'apparecchio e un computer	5
8.) Touchscreen	6
9.) WIFI	6
Connessione automatica	6
Collegamento manuale	7
10.) La schermata iniziale	8
Visualizzazione	8
Sblocco del display	8
Barra dello status	9
Adattamento della schermata di avvio	10
Utilizzare diverse schermate iniziali	10
Applicazioni già installate sulla schermata iniziale	11
11.) Menu principale applicazioni	11
12.) Invio / ricezione di e-mails	12
Configurazione della Sua casella di posta elettronica	12
Gestione degli account e-mail	13
Visualizzazione delle e-mails	13
Scrivere messaggi e-mail	13
13.) Browser internet	14
Utilizzo della tastiera virtuale	14
Inserimento di caratteri speciali	14
Utilizzo del browser internet	15
14.) Impostazioni sistema	15
Panoramica delle impostazioni principali	16
15.) Gestione di applicazioni	17
Installazione di applicazioni	17
Disinstallazione di applicazioni	17
16.) File Explorer	18
Navigare attraverso files e cartelle	18
Utilizzare la barra degli strumenti	18
Copiare, spostare e rinominare files e cartelle	18
17.) Condizioni di garanzia limitate	19
18.) Dati tecnici	19
19.) Manutenzione dell'apparecchio	20
20.) Pulizia dell'apparecchio	20
21.) Smaltimento di vecchi apparecchi elettrici	20
22.) Licenza informazione	21
Dichiarazione di conformità	25

Questo manuale non contiene eventualmente tutte le funzioni del Suo apparecchio. Per l'utilizzo di applicazioni derivanti da fornitori terzi, contatti il rispettivo fornitore. Consideri che tutte le informazioni possono essere modificate senza preavviso. Può trovare informazioni attuali su www.intenso.de.

Marchio di fabbrica

Google™, il logo Google™ e Android™ sono marchi di Google Inc. Tutti gli altri nomi di prodotti e servizi sono proprietà del rispettivo possessore.

2.) Note

- Evitare forti impatti sull'apparecchio. Non depositarlo su superfici oblique al fine di evitare una caduta.
- Non utilizzare l'apparecchio in zone estremamente fredde, calde, umide o polverose. Non esporlo alla luce solare diretta.
- Evitare l'utilizzo in posti sabbiosi.
- Non utilizzare l'apparecchio in zone a rischio d'esplosione, come ad esempio distributori di carburante presso una stazione di servizio.
- Evitare l'utilizzo su cuscini, divani o altri oggetti che supportano una potenziale fonte di calore, in quanto si creerebbe pericolo di surriscaldamento dell'apparecchio.
- Esegua spesso il backup dei dati per evitare una loro possibile perdita. Non siamo responsabili per eventuali perdite di dati.
- Non interrompere la connessione mentre i dati vengono trasmessi o l'apparecchio viene formattato. Potrebbe verificarsi la perdita dei dati.
- Immagini e video possono essere protetti da diritti di terzi. La loro esecuzione senza licenza può violare diritti di copyright.
- Evitare l'utilizzo in presenza di forti campi magnetici.
- Proteggere l'apparecchio dall'acqua. Se dell'umidità penetrasse nell'apparecchio, spegnerlo immediatamente, quindi pulirlo e asciugarlo.
- Non utilizzare soluzioni chimiche per pulire l'apparecchio. Utilizzare solo un panno asciutto.
- Non collocare in prossimità dell'apparecchio fiamme aperte, ad esempio candele accese.
- Non siamo responsabili per danni causati da un malfunzionamento per perdita di dati, utilizzo improprio, riparazione per conto proprio dell'apparecchio o sostituzione della batteria.
- Se l'apparecchio non dovesse reagire ai comandi, utilizzare il pulsante reset sul retro dell'apparecchio per riavviarlo.
- Se l'apparecchio non viene utilizzato, staccare l'alimentatore della corrente.
- La presa deve trovarsi nei pressi dell'apparecchio ed essere facilmente accessibile.
- Utilizzare l'adattatore solo con prese con messa a terra da AC 100-240V~, 50/60 Hz. In caso d'insicurezza riguardo l'alimentazione di corrente presso la collocazione dell'apparecchio, informarsi presso il fornitore d'energia in questione.
- Utilizzare solo il cavo dell'adattatore e di rete in fornitura.
- Per interrompere l'alimentazione di corrente all'apparecchio, estrarre l'alimentatore dalla presa. Tenere sempre ben fermo il trasformatore mentre lo si estrae. Non tirare mai il filo.
- Non aprire l'alloggiamento dell'adattatore. Aprendo l'alloggiamento sussiste pericolo di morte per scossa elettrica. Non contiene componenti che possono essere riparate.

- Se non si utilizza l'apparecchio per lungo tempo, la batteria si scarica lentamente. Prima del riutilizzo, quest'ultima dev'essere quindi ricaricata.
- Smaltire l'apparecchio o la batteria nel rispetto dell'ambiente.
- Non scomporre l'apparecchio in pezzi singoli e non cercare di ripararlo per conto proprio, in quanto la garanzia in questo caso decadrebbe.
- Non utilizzare l'apparecchio in posti dove l'utilizzo di apparecchi mobili è vietato. Non utilizzare l'apparecchio in prossimità di altri apparecchi elettronici, in quanto potrebbe verificarsi un'interferenza col segnale d'alta frequenza.
- Non utilizzare l'apparecchio nei pressi di pacemaker, in un ospedale o nei pressi di apparecchi medici, in quanto potrebbe verificarsi un'interferenza col segnale d'alta frequenza. Rivolgersi al produttore di questo apparecchio per ricevere informazioni su un utilizzo in concomitanza con altri dispositivi.
- Quando si utilizzano degli auricolari o delle cuffie ad un volume troppo elevato si possono verificare dei danni duraturi all'udito. La preghiamo di considerare che il volume costantemente elevato potrebbe causare danni permanenti all'udito. Al fine di evitare un possibile rischio alla salute causato da un volume troppo elevato, Le consigliamo di utilizzare le cuffie contenute nel volume di consegna.
- Per motivi di sicurezza nel traffico, l'apparecchio non può essere utilizzato durante la guida dal conducente stesso.

3.) Quadro generale dell'apparecchio

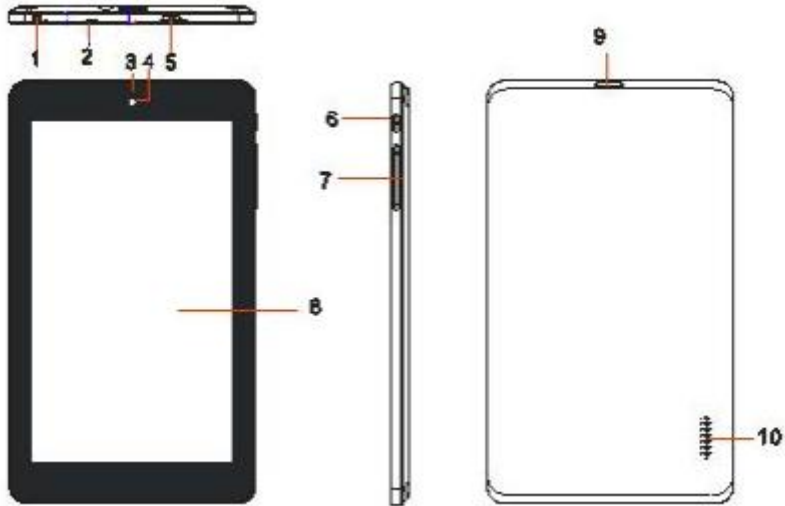

- (1) Porta 3.5mm per cuffie
- (2) Microfono integrato
- (3) Indicatore di ricarica: rosso durante il procedimento di ricarica – giallo a ricarica completa.
- (4) Fotocamera frontale
- (5) Porta micro USB

- (6) Tasto On / Off: premere a lungo per spegnere l'apparecchio; premere brevemente per passare dalla modalità standby alla modalità attiva
- (7) Volume + / -
- (8) Touchscreen
- (9) Slot per micro scheda SD
- (10) Altoparlanti integrati

4.) Contenuto della confezione

Verificare la completezza del contenuto del pacchetto:

- TAB 734
- Cavo USB
- Trasformatore 5V 1.2A
- Istruzioni

5.) Caricamento della batteria

Ricaricare completamente la batteria **prima** del primo utilizzo. Collegare l'alimentatore in dotazione all'apparecchio e a una presa. La ricarica completa dura circa **5 ore**. Lo stato della ricarica viene visualizzato sul lato **anteriore sinistro** dell'apparecchio. Il **LED** s'illumina di **rosso** durante la ricarica e diventa **giallo** quando la batteria è **completamente carica**.

Nota:

- a. Quando la carica rimasta della batteria raggiunge il 15%, riceverà un avviso sul display. Dovrebbe quindi ricaricare la batteria tramite il trasformatore inserito in una presa, al fine di evitare la perdita di dati e aumentare la durata della batteria.
 - b. Può utilizzare l'apparecchio mentre la batteria viene ricaricata. Per garantire una lunga durata della batteria, è opportuno non utilizzare l'apparecchio nel frattempo.
 - c. Per garantire una buona performance, la batteria incorporata dev'essere utilizzata spesso. Se utilizza solo raramente l'apparecchio, carichi completamente la batteria minimo una volta al mese.
 - d. Si assicuri di utilizzare solo il trasformatore dotato in fornitura per il caricamento.
-

6.) Utilizzo di una scheda Micro SD/SDHC/SDXC

Questo dispositivo può leggere dati **direttamente** da una **scheda micro SD/SDHC/SDXC** con una **capacità massima di 64 GB**. Per utilizzare una **scheda micro SD/SDHC/SDXC**, inserire la scheda nello slot apposto sul **lato sinistro del dispositivo**. Utilizzare l'**Explorer preinstallato** per accedere ai **dati** presenti sulla **scheda di memoria**. Selezionare quindi nell'**Explorer** la **cartella "SD Card"**.

7.) Trasmissione di dati tra l'apparecchio e un computer

- 1.) Collegare l'**apparecchio** con l'aiuto del **cavo USB** allegato con un **computer**.
- 2.) Sull'apparecchio comparirà quindi la **schermata** per il **collegamento USB**. Toccare **brevemente "Attivare memoria USB"**. L'apparecchio verrà riconosciuto come **supporto di memoria rimovibile** e riceverà il messaggio **"Memoria USB in utilizzo"**. Dopo aver toccato **brevemente** il **tasto Home**, si potrà **continuare ad utilizzare normalmente** l'apparecchio. Avrà ora accesso **dal Suo computer** alla **memoria interna dell'apparecchio** e potrà **copiare, cancellare o spostare** files sull'apparecchio.
- 3.) Se vi è una connessione USB con il computer, nella barra di stato si vedrà il simbolo USB. Nella barra di stato ampliata sono disponibili maggiori informazioni ed è possibile attivare o disattivare la connessione USB.
 - Per **disattivare** la memoria, selezionare **"Disattiva memoria USB"**.
 - Sul computer selezionare la **funzione „Rimozione sicura"**  per **staccare il dispositivo dal computer**.

Nota: Le applicazioni già installate e il sistema operativo Android™ occupano una parte della memoria interna. Per questo motivo non è a Sua disposizione l'intera memoria interna.

8.) Touchscreen

Questo dispositivo viene comandato mediante un **touch screen**. **Toccando lievemente** con le **dita** il **touch screen** si possono **avviare** in modo molto semplice **le applicazioni**, **inserire testi sulla tastiera virtuale** e **scorrendo nella relativa direzione**, si può navigare tra le **diverse schermate**.



Rimuova la **pellicola di protezione** dal **display** prima di **utilizzare** l'apparecchio.

Il **touchscreen** riconosce **cariche elettriche** minime, come ad esempio quella trasmessa dal dito umano e **stabilisce** così il **punto d'inserimento**.

Si consiglia quindi di utilizzare la **punta delle dita** per l'**inserimento**. L'utilizzo con un **pennino o un altro oggetto appuntito** non è possibile.

Il touchscreen non dovrebbe **entrare in contatto** con l'acqua o altri dispositivi elettrici, al fine di evitare **malfunzionamenti** e **difetti permanenti**.

Nota:

- Se il touchscreen non viene utilizzato per due minuti, l'apparecchio passa nella modalità standby. Premere brevemente il tasto On / Off per passare alla modalità attiva.
 - Per evitare inserimenti involontari, il blocco tasti si attiva automaticamente. Sbloccare i tasti dal touchscreen. Trascinare a questo scopo il simbolo del lucchetto dal basso verso l'altro sul display. L'apparecchio passerà ora alla schermata iniziale. Toccare il lucchetto chiuso  sul display e tenerlo premuto. Trascinare quindi il lucchetto sul lucchetto aperto  appena comparso e rilasciare il dito dal display. Lo schermo è ora sbloccato.
-

Può girare l'apparecchio in **tutte le direzioni**. Dispone di un **sensore** che orienta automaticamente il **display**.

9.) WIFI

Per collegare il dispositivo a **Internet**, è necessaria una **connessione WLAN**. Per configurarla, aprire le **impostazioni WLAN** nelle **impostazioni**.

Nota: Consideri che una rete WLAN deve trovarsi nel raggio della Sua posizione attuale.

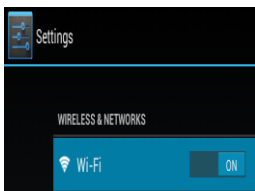

Connessione automatica

Aprire le impostazioni **WLAN** tramite le **impostazioni**. Qui è possibile **attivare** o **disattivare** la funzione WLAN in tutta semplicità. Spingere semplicemente l'**interruttore virtuale** dalla **posizione "ON"** verso sinistra per **disattivare** la funzione WLAN. La visualizzazione **passerà** su "OFF".

Per **riattivare** la **funzione WLAN disattivata**, spingere semplicemente l'**interruttore virtuale** verso destra.

Nelle **impostazioni WIFI** vengono visualizzate a destra tutte le **reti disponibili** e **tutte le reti già utilizzate**.

Tocchi la **rete desiderata** e inserisca eventualmente la **chiave WLAN** (password) corretta per **stabilire una connessione**.

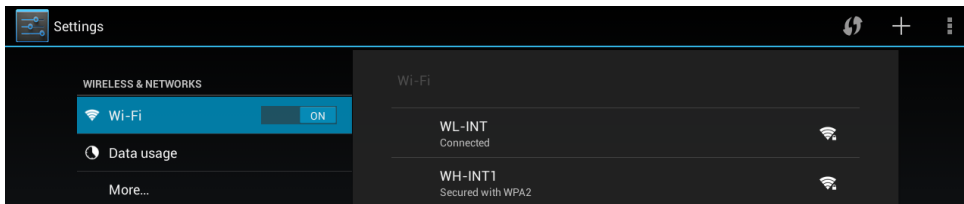

Confermate l'eventuale password inserita premendo il **tasto Enter** e premete **Collega**. Dopo **breve tempo la connessione è stabilita**.

Nota:

- a) Se l'apparecchio passa nella modalità standby, la WLAN viene disattivata automaticamente. Questo riduce il consumo di corrente e contribuisce così ad una durata maggiore della batteria. Se l'apparecchio passa di nuovo nella modalità attiva, il collegamento WLAN verrà ripristinato automaticamente. Questo può durare qualche secondo.
 - b) La lista attuale delle reti WLAN trovate viene aggiornata automaticamente.
 - c) Se la funzione WLAN è attiva, l'apparecchio si collegherà automaticamente con una rete già configurata, se si trova nel suo raggio.
 - d) Se una rete WLAN sconosciuta si trova nei paraggi, viene visualizzato un campo con le relative informazioni.
-

Collegamento manuale

Per **cercare** manualmente una rete Wifi **raggiungibile**, procedere come segue:



- (1) Aprire le **Impostazioni**.
- (2) Aprire ora le **impostazioni WLAN**, premere i tre punti in alto a destra e selezionare infine **“Cerca”**.
- (3) Se la rete Wifi non compare nell'elenco delle reti disponibili, selezionare la voce **“Aggiungi rete”** per inserire manualmente la rete SSID, il protocollo di sicurezza ed eventualmente la relativa password. Per confermare i dati inseriti, toccare **“Salva”**.

10.) La schermata iniziale

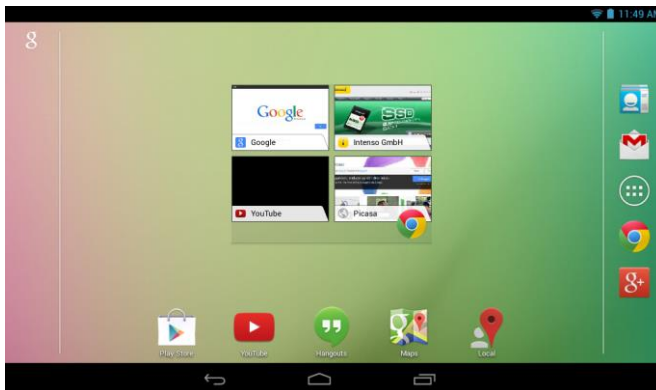
Visualizzazione



Sblocco del display

Se il touchscreen **non viene utilizzato per due minuti**, l'apparecchio passa automaticamente alla **modalità standby**. Premere **brevemente il tasto on / off** per passare alla **modalità attiva**. Il **display** è bloccato **per impedire digitazioni involontarie**. Toccare il **lucchetto chiuso**  sul display e **tenerlo premuto**. **Trascinare** quindi il **lucchetto** sul **lucchetto aperto**  appena comparso e **rilasciare il dito dal display**. Lo **schermo** è ora **sbloccato**.

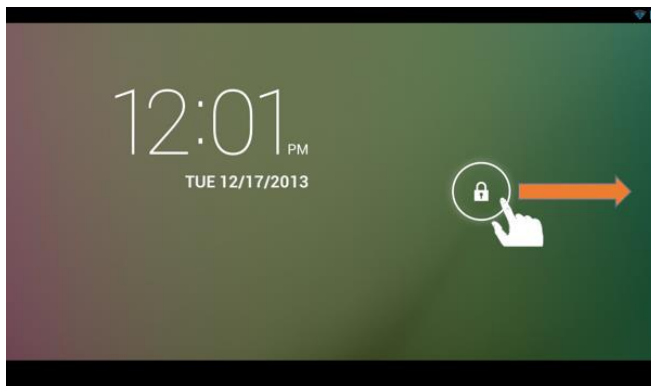

Trascini il simbolo del lucchetto con le dita nella direzione della freccia.

Nota: Trascinare il simbolo del lucchetto sul **simbolo** comparso della **fotocamera** per aprire direttamente l'**applicazione della fotocamera**.

Barra dello status

La **barra dello status** si trova nella parte **superiore** e **inferiore** della **schermata iniziale**.

La **barra superiore** si suddivide in **due ambiti**. Se si trascina la barra verso il basso **a sinistra**, verranno visualizzate, se presenti, le **notifiche attuali**.

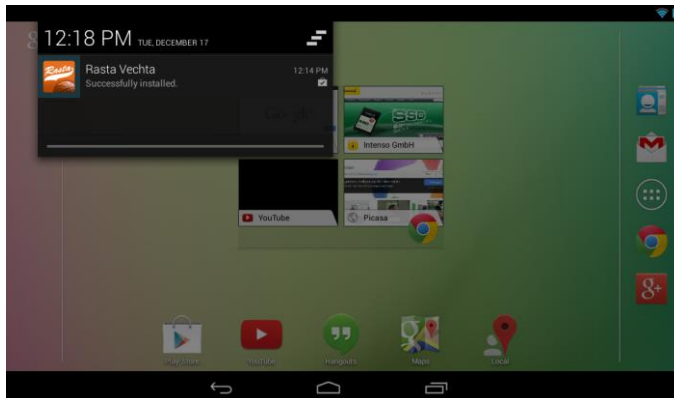

Se si trascina la barra verso il basso **a destra**, verranno visualizzati i **campi di accesso rapido** per **diverse impostazioni**.

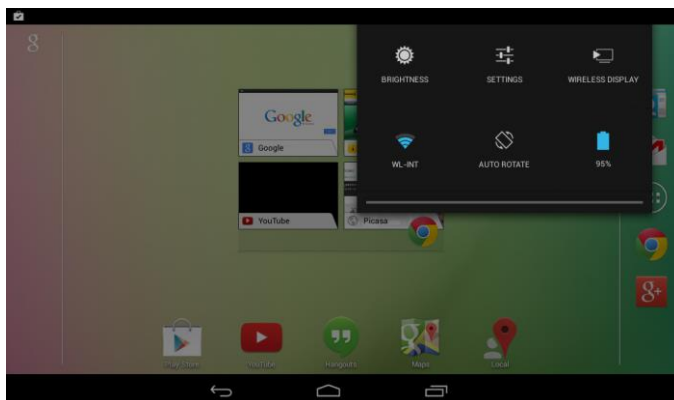

La **barra inferiore** offre la possibilità di: passare alla **schermata precedente** o **nascondere la tastiera**, se visualizzata, **aprire** direttamente la **schermata iniziale**, visualizzare i **programmi utilizzati di recente** e **regolare il volume** del dispositivo.



Adattamento della schermata di avvio

È possibile adattare la **schermata di avvio** alle proprie **esigenze individuali** in modo molto semplice. Se si vuole cancellare un'icona, toccare un **po' più a lungo** con il dito l'icona e spollarla sul **simbolo X** scoperto. **Togliere ora il dito dal touch screen** e l'icona viene cancellata.

Se si desidera spostare un'icona dalla **panoramica delle applicazioni** alla **schermata iniziale**, premere un **pò più a lungo** sull'icona nella **panoramica delle applicazioni**: comparirà la **schermata iniziale**. **Spostare l'icona nel punto desiderato e togliere il dito dal touch screen**. L'**icona** è stata **aggiunta** alla schermata iniziale. Se si posiziona un'icona su un'altra icona, viene creata automaticamente una cartella che contiene le due icone. Toccare la cartella per visualizzare le icone in essa contenute e selezionare poi toccandola brevemente l'icona desiderata.

Inoltre, è possibile aggiungere **widget** alla **schermata iniziale**. Per farlo, aprire la **panoramica delle applicazioni** e premere la parola **Widget**: verranno visualizzati tutti i **widget disponibili sul dispositivo**. L'**aggiunta** di un **widget** sulla **schermata iniziale** funziona esattamente come l'**aggiunta** di un'icona.

Se si desidera cambiare l'immagine dello sfondo, toccare semplicemente un punto libero della schermata iniziale e tenere premuto il dito sul display fino a che compare il menu di selezione dello sfondo.

Utilizzare diverse schermate iniziali

Sono a Sua disposizione **cinque schermate individuali impostabili in modo personale**. Con un **leggero sfioramento** verso **sinistra o destra**, può **passare** facilmente da una all'altra.

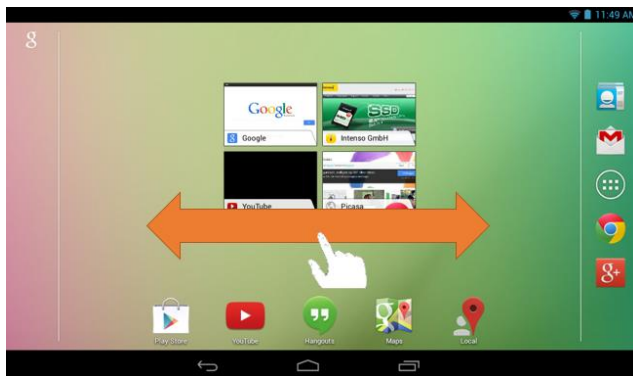

Premendo il tasto Home tornerà sempre automaticamente alla fermata iniziale nel mezzo.

Applicazioni già installate sulla schermata iniziale

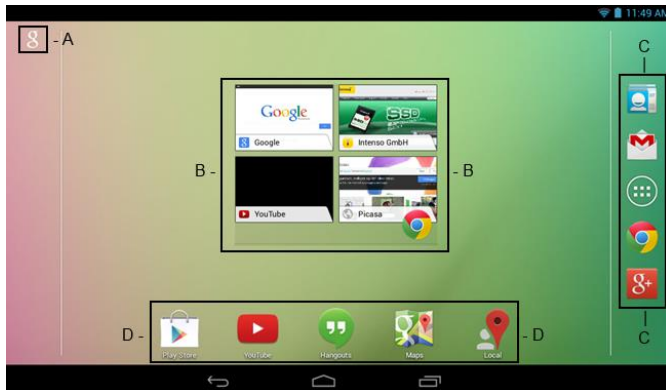

A Collegamento alla ricerca Google™

B Bookmark Panoramica per il browser Chrome™

C Contatti, Gmail™, Menù principale applicazioni, Chrome™ e Google+™

D Google Play Store™, YouTube™, Hangouts™, Maps™ e Local™

11.) Menù principale applicazioni



Tocchi **brevemente** l'icona del **Menù principale applicazioni** per **aprire** il **menù principale delle applicazioni**. Visualizzerà quindi un **quadro d'insieme** di tutte le **applicazioni predefinite** e da Lei già **installate**. Apra l'**applicazione desiderata** toccando **brevemente** la relativa **icona**.

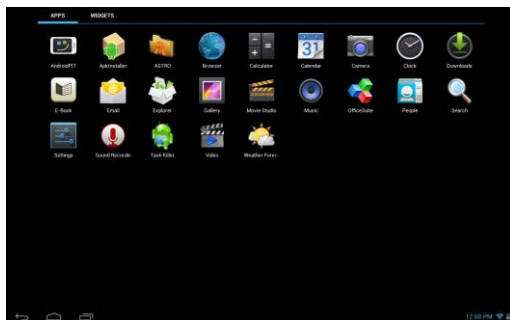

Menù principale applicazioni

12.) Invio / ricezione di e-mails

Su questo apparecchio è già installata un'**applicazione per le e-mails**. Può in questo modo **utilizzare** i Suoi account già **esistenti** per **inviare** e **ricevere** e-mails.

Nota: Per questa funzione è necessario un **collegamento WLAN** ad internet.

Apra l'applicazione tramite l'icona „E-Mail“ che si trova nel **menù delle applicazioni**.

Configurazione della Sua casella di posta elettronica

- (1) **Avvii** l'applicazione dell'e-mail **toccando** il simbolo **E-Mail**. Le verrà quindi richiesto di **configurare** la Sua **casella di posta elettronica**.
- (2) Inserisca il Suo **indirizzo e-mail** e la relativa **password**, quindi tocchi **“Avanti”**. Infine **dia un nome** al Suo **account** e **stabilisca** il Suo **nome** che deve essere **visualizzato** per la **posta in uscita**. Tocchi **“Finito”** per **concludere** la **configurazione**. La Sua **casella di posta elettronica** viene selezionata come **casella standard** se seleziona l'opzione **“Inviare e-mails sempre da questo account”**.
- (3) Può configurare la Sua **casella di posta elettronica** anche **manualmente**. Inserisca il Suo **indirizzo e-mail** e la **relativa password**, quindi tocchi **infine “Setup manuale”** per registrare le informazioni sul **server dell'account**.
- (4) **Selezioni** il tipo di server **POP3, IMAP o Exchange** per **ricevere** le e-mails.

Nota: Se non sa come configurare le impostazioni, contatti il gestore del Suo account, il Suo amministratore di rete oppure cerchi in internet le relative informazioni necessarie indicando termini come „Indirizzo POP“ e „Nome del mio provider“.



- (5) Inserisca le **informazioni** necessarie (server, porta ecc.).
- (6) Selezioni il **tipo di server** per **inviare** le **e-mails** e inserisca le **informazioni necessarie**.
- (7) Tocchi **“Avanti”** per **procedere** nel **menù**. L'applicazione dell'e-mail **verificherà** le **impostazioni del server dell'account**. Dopo aver **portato a buon fine la configurazione**, visualizzerete il messaggio **“Your account is set up, and email is on its way”**. Il Suo account è ora **configurato**.
- (8) Dia un **nome** alla Sua **casella di posta** e tocchi **„Finito“** per **concludere** la procedura.

Nota: Se dovesse possedere più di un account, ad ogni avvio dell'applicazione dell'e-mail verrà aperto l'account predefinito.

Gestione degli account e-mail

Aggiungere una nuova casella di posta:

- (1) Aprire l'**applicazione E-mail** e toccare il **tasto di menu**  per visualizzare le **altre opzioni**. Selezionare la voce di menu **"Impostazioni"** e poi **"Aggiungi account"**, per creare una nuova **casella di posta**.
- (2) Seguire i **tutorial di configurazione per creare una nuova casella di posta**.

Cancellare una casella di posta:

- (1) Aprire l'**applicazione E-mail** e toccare il **tasto di menu**  per visualizzare le **altre opzioni**. Selezionare la voce di menu **"Impostazioni"** e poi **"Elimina account"**, per cancellare la **casella di posta** desiderata.

Controllo delle caratteristiche dell'account:

- (1) Aprire l'**applicazione E-mail** e toccare il **tasto di menu**  per visualizzare le **altre opzioni** e selezionare **"Impostazioni"**. Sul **lato sinistro** del menu vengono ora visualizzate **tutte le caselle di posta già create**.
- (2) Toccare la **casella di posta desiderata** per visualizzare le impostazioni dell'account.
- (3) Toccare l'**"Impostazione account"** da cambiare, per eseguire le **modifiche desiderate**.

Visualizzazione delle e-mails

Apra l'**applicazione dell'e-mail** con un **breve tocco sull'icona E-mail**. Visualizzerà la **casella di posta già impostata**.

- Con un **movimento di sfioramento in verticale** può **far scorrere** le e-mails.
- Tocchi **brevemente** una **certa e-mail** per **aprirla**.
- Tocchi e **mantenga** il dito **su una certa e-mail** per visualizzare le **impostazioni avanzate**. Apparirà quindi un **campo informativo**. Qui può ora **aprire l'e-mail, rispondere, inoltrarla o cancellarla**.

Scrivere messaggi e-mail

- (1) Nella schermata della e-mail, toccare il **simbolo E-mail** nella **barra di menu superiore**; si apre una **nuova finestra** nella quale si può **scrivere una nuova e-mail**.
- (2) Inserire ora l'**indirizzo e-mail del destinatario**, un **oggetto** e il **testo** negli **appositi campi**. Si può aggiungere anche **„Cc/Bcc“** per inviare una e-mail a più destinatari.
- (3) Toccare la voce **"Invia"**, per **inviare l'e-mail**. Toccare **"Salva"**, per **salvare come bozza l'e-mail creata**. Toccando il **"Simbolo cestino"** l'**attuale e-mail** viene **eliminata**.

Nota: Per questa funzione è necessario un **collegamento WLAN** ad internet.

13.) Browser internet

Per avviare il **browser internet**, tocchi l'**icona del Browser**  nella **schermata iniziale**. Per aprire un **sito internet**, tocchi il **campo superiore** per inserire l'**indirizzo internet**. La **tastiera virtuale** si aprirà e poi potrai inserire l'**indirizzo del sito internet** desiderato. Clicchi su "**Vai**" o sul **simbolo della freccia di fianco** al **campo d'inserimento** per aprire il **sito internet**.

Nota: Non tutte le reti offrono un accesso a internet. Alcune reti offrono un accesso ad altri computer collegati localmente e non un collegamento a internet.

Utilizzo della tastiera virtuale

Tocchi il **campo d'inserimento** per aprire la **tastiera virtuale**. Può quindi **inserire testi** o **aprire siti internet**.





- Blocco maiuscole (caratteri minuscoli o maiuscoli)
- Tasto per cancellare
- Apertura del menù per inserire numeri, lettere e caratteri speciali
- Barra spaziatrice (inserimento di uno spazio)
- Vai (Conferma dell'inserimento)

Inserimento di caratteri speciali

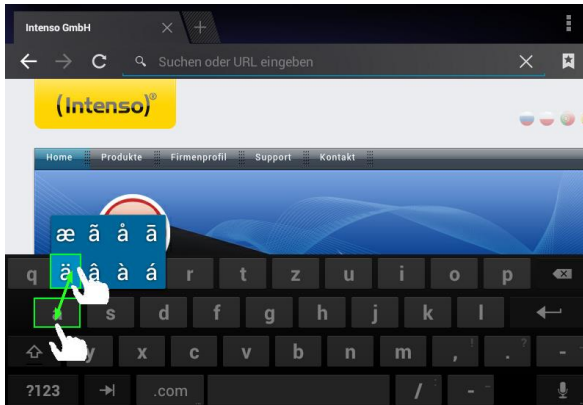
Per inserire un carattere speciale, come per esempio "ä", toccare **a lungo** col **dito** il tasto "a" per richiamare il **menu dei segni speciali**. Ora col dito trascinare il segno speciale che si desidera, per esempio "ä" e staccare di nuovo il dito dal display. È stata inserita una "ä".



Utilizzo del browser internet

- Può far scorrere la **visualizzazione sul display** eseguendo un **movimento di sfioramento in verticale** con il **dito**. Non inizi il movimento da un punto del menù o da un link, altrimenti verrà aperto il **collegamento presente**.
- Per aprire un **link**, tocchi semplicemente il **link**. La nuova **pagina** si aprirà **automaticamente**.
- Per aprire il menu **Web Browser**, premere il tasto menu . Qui sono disponibili diverse funzioni. Fra le altre cose, qui si **può aggiornare il sito web aperto, aprire un nuovo tab, rendere leggibili i siti web offline** oppure passare alle **Impostazioni del Web Browser**.
- Per **tornare indietro** alla pagina **precedente**, prema il **tasto Indietro** .
- Per tornare indietro **direttamente** alla **schermata iniziale**, prema il **tasto Home** .
- Per inserire un **testo**, tocchi il **campo corrispondente** e utilizzi la **tastiera virtuale** per **inserire il testo**.

Nota: Per questa funzione è necessario un collegamento WLAN ad internet.

14.) Impostazioni sistema

Toccare nel **menu Applicazioni** l'**icona Impostazioni** per richiamare le **impostazioni di sistema**.

- Sul **lato sinistro del menu** si trovano le singole **categorie**. **Premendo brevemente** sulla **voce di menu** che interessa, vengono visualizzate le **possibilità di configurazione disponibili**. Si prega di notare che eventualmente alcune funzioni offerte da Android™ potrebbero non essere compatibili con questo dispositivo.
- Una volta eseguite **tutte le impostazioni**, con il **tasto Indietro**  si può tornare al **menu richiamato per ultimo**, oppure con il **tasto Home**  si può passare direttamente alla **schermata di avvio**. Gli **inserimenti eseguiti** saranno **salvati automaticamente**.

Panoramica delle impostazioni principali

Wireless & reti	Wifi	Eseguire qui le proprie impostazioni Wifi.
	Altro	Qui si possono eseguire altre impostazioni di rete.
Dispositivo	Suoni	Qui si imposta il volume desiderato e il tono di avviso desiderato. È inoltre possibile attivare o disattivare un tono di conferma quando si tocca il touch-screen e un tono di avviso quando si sblocca il blocco del display.
	Display	Luminosità – adattamento della luminosità del display. Sfondo – selezione dello sfondo preferito. Riposo – adattamento del ritardo prima dello spegnimento automatico del display. Dimensione caratteri – impostazione della dimensione carattere desiderata.
	Memoria	Qui si trovano informazioni sulla memoria interna e – se utilizzata – su una scheda Micro SD. È inoltre possibile cancellare il contenuto della memoria.
	Batteria	Qui si trovano informazioni sullo stato di carica della batteria integrata.
	Apps	Qui si possono gestire le applicazioni installate e ricevere informazioni sulle applicazioni.
	Utente	Servizi sede
Sicurezza		Qui si può configurare ad esempio il blocco dello schermo ed eseguire altre impostazioni importanti per la sicurezza.
Lingua & inserimento		Qui si può impostare per esempio la propria lingua preferita, aggiungere diverse voci al proprio vocabolario personale ed eseguire diverse impostazioni per la tastiera.
Salvare & resettare		Qui si possono salvare le proprie impostazioni di sistema e i dati delle applicazioni su server Google™. Inoltre si possono ripristinare le impostazioni iniziali di fabbrica. ATTENZIONE: per farlo, vengono cancellati tutti i dati salvati sul dispositivo.
Conti	Aggiungere un conto	Qui può aggiungere diversi conti.
Sistema	Data & ora	Qui si possono definire data, ora, fuso orario e formato della visualizzazione.
	Info sul tablet	Mostra informazioni sul dispositivo.

15.) Gestione di applicazioni

Applicazioni già installate

Questo apparecchio viene fornito con delle **applicazioni già installate**. Può trovare una **panoramica delle applicazioni** già installate nel **menù principale delle applicazioni** . Per **aprire** una di queste **applicazioni**, tocchi **brevemente** la **rispettiva icona**.

Installazione di applicazioni

Per **installare applicazioni** sull'apparecchio, esegua i **seguenti passi**:

- (1) Aprire la **sorgente desiderata** per il **download di applicazioni**, ad esempio il **Google Playstore™** già installato. A tale scopo è necessario prima accedere al **Playstore™ con il proprio account esistente** oppure crearne **uno nuovo**. Seguire semplicemente le **istruzioni** sulla **schermata**.
- (2) Dopo aver effettuato l'**accesso** avrete a disposizione una vasta **scelta di applicazioni** del **Google Playstore™**. Selezionare l'**applicazione desiderata**, premere **installare** e **confermare** eventualmente i **diritti di accesso** dell'applicazione. Inizierà quindi il **download** e il suo **avanzamento** verrà indicato sulla **barra di status** estesa in alto a sinistra.
- (3) Dopo il **download** dell'applicazione, quest'ultima verrà automaticamente installata. Dopo essere stata installata, la nuova **applicazione** si troverà nel **menù delle applicazioni**. L'**avanzamento dell'installazione** si trova sulla **barra di status** estesa in alto a sinistra.

Disinstallazione di applicazioni





- (1) Aprire le **Impostazioni di sistema** toccando brevemente l'**icona Impostazioni** nella panoramica delle applicazioni.
- (2) Toccare ora la voce di menu "**Apps**", per accedere alle **Impostazioni delle applicazioni**.
- (3) Scegliere tra le voci principali di menu "**Scaricato, memoria USB, attivo e**" la panoramica applicazioni desiderata **toccandola** brevemente.
- (4) Poi, **toccandola**, selezionare l'**applicazione** che si vuole **disinstallare**.
- (5) Toccare ora "**Disinstalla**" e **confermare** la scelta con **OK**, per disinstallare l'**applicazione** dal **dispositivo**.

Nota: Non può eliminare software già installati in dotazione.

16.) File Explorer

Apra il **menù principale delle applicazioni** e tocchi infine brevemente l'**icona Explorer** per avviare il **File Explorer**.

Navigare attraverso files e cartelle

- Può scegliere la **memoria interna** (internal memory), la **scheda di memoria** (SD Card) e l'**USB**. Tocchi la **destinazione desiderata** per visualizzare i **files contenuti** come **lista**. Se **non** è stata inserita una **scheda di memoria** o un **supporto di memoria connesso** tramite il **collegamento**, Le sarà comunicato che il dispositivo in questione „... **non è installato**“.
- Con un **movimento di sfioramento in verticale** può far scorrere quindi i Suoi **files** e le Sue **cartelle**.
- Può effettuare un **passo avanti**  o **indietro**  cliccando brevemente sulla rispettiva **icona**.
- Per raggiungere all'interno della **struttura di una cartella** un **livello superiore**, tocchi brevemente l'**icona LevelUp** .
- Con l'**icona Home**  può passare **direttamente all'indice principale**.



Utilizzare la barra degli strumenti



Toccare il **tasto menu**  e su di esso “Hide Toolbar”, per visualizzare e nascondere la **barra degli strumenti**

Home	Passa direttamente all'indice principale.
LevelUp	Passa a un livello superiore.
Multi	Seleziona più files.
Editor	Copia, cancella, sposta, incolla o rinomina un file o una cartella.
New Folder	Creare una nuova cartella.
Back	Un passo indietro.
Next	Un passo avanti.

Copiare, spostare e rinominare files e cartelle

- 1.) **Navighi** fino a raggiungere il **file desiderato** nella **panoramica dei files**.
- 2.) Tocchi e **mantenga** il dito **sul file** fino a quando compare un **campo informativo**.
- 3.) Selezioni la **funzione desiderata**. Può scegliere tra **copiare** (copy), **eliminare** (delete), **spostare** (move), **incollare** (paste) – per questo il files deve trovarsi copiato negli **appunti** - e **rinominare** (rinomina).
- 4.) Per **copiare** o **spostare**, tocchi brevemente l'**icona corrispondente** (copy / move) e **navighi** infine fino all'**indice**. Tocchi infine l'**icona Editor**  e selzioni con un **breve tocco „Incolla“**, per **incollare un file**.
- 5.) Per **cancellare** un **file**, tocchi „**Elimina**“ e **confermi** ancora per **sicurezza** con „**Elimina**“.
Per **annullare**, tocchi brevemente „**Annulla**“.
- 6.) Per **rinominare** un **file**, tocchi „**Rinomina**“ e inserisca infine attraverso la **tastiera virtuale** il **nuovo nome del file**. **Confermi** il Suo **inserimento** con „**OK**“ annulli il **processo** con „**Annulla**“.
- 7.) Può **copiare, eliminare** o **spostare contemporaneamente più files** e **cartelle**. Tocchi a questo scopo l'**icona Multi**  e infine i files desiderati. I **files marcati** verranno quindi visualizzati in un **altro colore**. Tocchi l'**icona Editor**  per eseguire l'**azione desiderata**.

17.) Condizioni di garanzia limitate

La garanzia copre solo la sostituzione di questo prodotto Intenso. La garanzia non vale per normale usura derivante da uso errato o improprio, trascuratezza, incidente, incompatibilità o da altre prestazioni manchevoli di un certo hardware o software.

Non sussiste garanzia col mancato rispetto delle istruzioni Intenso, così come col montaggio e uso improprio o con difetti causati da altri apparecchi.

Se il prodotto viene esposto a scosse, scariche elettrostatiche, calore o umidità non in conformità alle specifiche del prodotto, non sussiste alcuna garanzia.

Intenso non è responsabile per perdite di dati o per danni concomitanti e conseguenti, per la violazione delle condizioni di garanzia o per altri danni indipendentemente dalla loro causa.

Questo prodotto non è previsto per un uso commerciale o per applicazioni mediche o di altro genere dove il mancato funzionamento del prodotto possa causare ferimenti, morte o notevoli danni materiali.

18.) Dati tecnici

CPU	1.0 GHz Dualcore based on Cortex A9
Memoria	1 GB DDR 3
Sistema operativo	Android 4.2.2
Sistemi operativi compatibili	Windows XP / Vista / 7 / 8 / Linux 2,4 e più recenti / Mac 10.6 e più recenti
Possibilità di collegamento	Cuffie, Micro SD (SDHC/SDXC), micro USB
WLAN	WiFi (802.11 b/g/n)
Sensore G	360 Grad Rotation
Formato foto	JPEG, BMP, GIF, PNG
Formato audio	MP3, WMA, WAV, OGG, FLAC, APE
Formato video	MPEG1, MPEG 4, FLV
Display	TFT LCD Display, 1024 x 600 Pixel
Fotocamera	Fotocamera frontale 0,3 MP
SNR	>= 80 dB
Campo di frequenza	20 Hz – 20 KHz
Trasformatore	(V) AC Adapter (HUONIO HNBC050120UE): AC Input 100-240V~50/60Hz, DC Output 5V / 1.2A
Batteria interna	Batteria ricaricabile agli ioni di litio-polimero

19.) Manutenzione dell'apparecchio

Non spruzzare o applicare mai un liquido direttamente sul display o sull'alloggiamento.

20.) Pulizia dell'apparecchio

Pulisca l'alloggiamento, il telaio e il display con attenzione tramite un panno morbido, non sfilacciato e privo di sostanze chimiche. Utilizzi detergenti solo se sono previsti per displays.

21.) Smaltimento di vecchi apparecchi elettrici

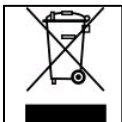

Gli apparecchi contrassegnati da questo simbolo sono soggetti alla direttiva europea 2002/96/EC. Tutti gli apparecchi elettrici vecchi e non devono essere smaltiti separatamente dai rifiuti domestici presso i luoghi previsti dallo stato. Con uno smaltimento corretto dei vecchi apparecchi elettrici evita danni all'ambiente.

(Intenso)[®]

49377 Vechta
Germany
www.intenso.de



22.) Licenza informazione

Notice of GNU GENERAL PUBLIC LICENSE and LESSER GENERAL PUBLIC LICENCE

Dear Customer,

If interested, you and any third party can download the source code of used GPL / LGPL from Intenso Webpage <http://www.intenso.de>. The source code of the desired product is available to anyone on the selection of valid product category and the desired device. In the product details you will find the entry "drivers". Open this menu to download the corresponding GPL / LGPL code. For a fee of 35 € (delivery to another country as Germany), it is also possible to obtain this code by postal delivery. More information about the GPL/LGPL-Licence can you find on following website www.gnu.org

GNU GENERAL PUBLIC LICENSE

Version 2, June 1991

Copyright (C) 1989, 1991 Free Software Foundation, Inc.

51 Franklin Street, Fifth Floor, Boston, MA 02110-1301, USA

Everyone is permitted to copy and distribute verbatim copies of this license document, but changing it is not allowed.

Preamble

The licenses for most software are designed to take away your freedom to share and change it. By contrast, the GNU General Public License is intended to guarantee your freedom to share and change free software--to make sure the software is free for all its users. This General Public License applies to most of the Free Software Foundation's software and to any other program whose authors commit to using it. (Some other Free Software Foundation software is covered by the GNU Lesser General Public License instead.) You can apply it to your programs, too.

When we speak of free software, we are referring to freedom, not price. Our General Public Licenses are designed to make sure that you have the freedom to distribute copies of free software (and charge for this service if you wish), that you receive source code or can get it if you want it, that you can change the software or use pieces of it in new free programs; and that you know you can do these things.

To protect your rights, we need to make restrictions that forbid anyone to deny you these rights or to ask you to surrender the rights. These restrictions translate to certain responsibilities for you if you distribute copies of the software, or if you modify it.

For example, if you distribute copies of such a program, whether gratis or for a fee, you must give the recipients all the rights that you have. You must make sure that they, too, receive or can get the source code. And you must show them these terms so they know their rights.

We protect your rights with two steps: (1) copyright the software, and (2) offer you this license which gives you legal permission to copy, distribute and/or modify the software.

Also, for each author's protection and ours, we want to make certain that everyone understands that there is no warranty for this free software. If the software is modified by someone else and passed on, we want its recipients to know that what they have is not the original, so that any problems introduced by others will not reflect on the original authors' reputations.

Finally, any free program is threatened constantly by software patents. We wish to avoid the danger that redistributors of a free program will individually obtain patent licenses, in effect making the program proprietary. To prevent this, we have made it clear that any patent must be licensed for everyone's free use or not licensed at all.

The precise terms and conditions for copying, distribution and modification follow.

TERMS AND CONDITIONS FOR COPYING, DISTRIBUTION AND MODIFICATION

0. This License applies to any program or other work which contains a notice placed by the copyright holder saying it may be distributed under the terms of this General Public License. The "Program", below, refers to any such program or work, and a "work based on the Program" means either the Program or any derivative work under copyright law: that is to say, a work containing the Program or a portion of it, either verbatim or with modifications and/or translated into another language. (Hereinafter, translation is included without limitation in the term "modification".) Each licensee is addressed as "you".

Activities other than copying, distribution and modification are not covered by this License; they are outside its scope. The act of running the Program is not restricted, and the output from the Program is covered only if its contents constitute a work based on the Program (independent of having been made by running the Program). Whether that is true depends on what the Program does.

1. You may copy and distribute verbatim copies of the Program's source code as you receive it, in any

medium, provided that you conspicuously and appropriately publish on each copy an appropriate copyright notice and disclaimer of warranty; keep intact all the notices that refer to this License and to the absence of any warranty; and give any other recipients of the Program a copy of this License along with the Program. You may charge a fee for the physical act of transferring a copy, and you may at your option offer warranty protection in exchange for a fee.

2. You may modify your copy or copies of the Program or any portion of it, thus forming a work based on the Program, and copy and distribute such modifications or work under the terms of Section 1 above, provided that you also meet all of these conditions:

- a) You must cause the modified files to carry prominent notices stating that you changed the files and the date of any change.
 - b) You must cause any work that you distribute or publish, that in whole or in part contains or is derived from the Program or any part thereof, to be licensed as a whole at no charge to all third parties under the terms of this License.
 - c) If the modified program normally reads commands interactively when run, you must cause it, when started running for such interactive use in the most ordinary way, to print or display an announcement including an appropriate copyright notice and a notice that there is no warranty (or else, saying that you provide a warranty) and that users may redistribute the program under these conditions, and telling the user how to view a copy of this License. (Exception: if the Program itself is interactive but does not normally print such an announcement, your work based on the Program is not required to print an announcement.)
- These requirements apply to the modified work as a whole. If identifiable sections of that work are not derived from the Program, and can be reasonably considered independent and separate works in themselves, then this License, and its terms, do not apply to those sections when you distribute them as separate works. But when you distribute the same sections as part of a whole which is a work based on the Program, the distribution of the whole must be on the terms of this License, whose permissions for other licensees extend to the entire whole, and thus to each and every part regardless of who wrote it. Thus, it is not the intent of this section to claim rights or contest your rights to work written entirely by you; rather, the intent is to exercise the right to control the distribution of derivative or collective works based on the Program.

In addition, mere aggregation of another work not based on the Program with the Program (or with a work based on the Program) on a volume of a storage or distribution medium does not bring the other work under the scope of this License.

3. You may copy and distribute the Program (or a work based on it, under Section 2) in object code or executable form under the terms of Sections 1 and 2 above provided that you also do one of the following:

- a) Accompany it with the complete corresponding machine-readable source code, which must be distributed under the terms of Sections 1 and 2 above on a medium customarily used for software interchange; or,
- b) Accompany it with a written offer, valid for at least three years, to give any third party, for a charge no more than your cost of physically performing source distribution, a complete machine-readable copy of the corresponding source code, to be distributed under the terms of Sections 1 and 2 above on a medium customarily used for software interchange; or,
- c) Accompany it with the information you received as to the offer to distribute corresponding source code. (This alternative is allowed only for noncommercial distribution and only if you received the program in object code or executable form with such an offer, in accord with Subsection b above.)

The source code for a work means the preferred form of the work for making modifications to it. For an executable work, complete source code means all the source code for all modules it contains, plus any associated interface definition files, plus the scripts used to control compilation and installation of the executable. However, as a special exception, the source code distributed need not include anything that is normally distributed (in either source or binary form) with the major components (compiler, kernel, and so on) of the operating system on which the executable runs, unless that component itself accompanies the executable.

If distribution of executable or object code is made by offering access to copy from a designated place, then offering equivalent access to copy the source code from the same place counts as distribution of the source code, even though third parties are not compelled to copy the source along with the object code.

4. You may not copy, modify, sublicense, or distribute the Program except as expressly provided under this License. Any attempt otherwise to copy, modify, sublicense or distribute the Program is void, and will automatically terminate your rights under this License. However, parties who have received copies, or rights, from you under this License will not have their licenses terminated so long as such parties remain in full compliance.

5. You are not required to accept this License, since you have not signed it. However, nothing else grants you permission to modify or distribute the Program or its derivative works. These actions are prohibited by

law if you do not accept this License. Therefore, by modifying or distributing the Program (or any work based on the Program), you indicate your acceptance of this License to do so, and all its terms and conditions for copying, distributing or modifying the Program or works based on it.

6. Each time you redistribute the Program (or any work based on the Program), the recipient automatically receives a license from the original licensor to copy, distribute or modify the Program subject to these terms and conditions. You may not impose any further restrictions on the recipients' exercise of the rights granted herein. You are not responsible for enforcing compliance by third parties to this License.

7. If, as a consequence of a court judgment or allegation of patent infringement or for any other reason (not limited to patent issues), conditions are imposed on you (whether by court order, agreement or otherwise) that contradict the conditions of this License, they do not excuse you from the conditions of this License. If you cannot distribute so as to satisfy simultaneously your obligations under this License and any other pertinent obligations, then as a consequence you may not distribute the Program at all. For example, if a patent license would not permit royalty-free redistribution of the Program by all those who receive copies directly or indirectly through you, then the only way you could satisfy both it and this License would be to refrain entirely from distribution of the Program.

If any portion of this section is held invalid or unenforceable under any particular circumstance, the balance of the section is intended to apply and the section as a whole is intended to apply in other circumstances. It is not the purpose of this section to induce you to infringe any patents or other property right claims or to contest validity of any such claims; this section has the sole purpose of protecting the integrity of the free software distribution system, which is implemented by public license practices. Many people have made generous contributions to the wide range of software distributed through that system in reliance on consistent application of that system; it is up to the author/donor to decide if he or she is willing to distribute software through any other system and a licensee cannot impose that choice. This section is intended to make thoroughly clear what is believed to be a consequence of the rest of this License.

8. If the distribution and/or use of the Program is restricted in certain countries either by patents or by copyrighted interfaces, the original copyright holder who places the Program under this License may add an explicit geographical distribution limitation excluding those countries, so that distribution is permitted only in or among countries not thus excluded. In such case, this License incorporates the limitation as if written in the body of this License.

9. The Free Software Foundation may publish revised and/or new versions of the General Public License from time to time. Such new versions will be similar in spirit to the present version, but may differ in detail to address new problems or concerns.

Each version is given a distinguishing version number. If the Program specifies a version number of this License which applies to it and "any later version", you have the option of following the terms and conditions either of that version or of any later version published by the Free Software Foundation. If the Program does not specify a version number of this License, you may choose any version ever published by the Free Software Foundation.

10. If you wish to incorporate parts of the Program into other free programs whose distribution conditions are different, write to the author to ask for permission. For software which is copyrighted by the Free Software Foundation, write to the Free Software Foundation; we sometimes make exceptions for this. Our decision will be guided by the two goals of preserving the free status of all derivatives of our free software and of promoting the sharing and reuse of software generally.

NO WARRANTY

11. BECAUSE THE PROGRAM IS LICENSED FREE OF CHARGE, THERE IS NO WARRANTY FOR THE PROGRAM, TO THE EXTENT PERMITTED BY APPLICABLE LAW. EXCEPT WHEN OTHERWISE STATED IN WRITING THE COPYRIGHT HOLDERS AND/OR OTHER PARTIES PROVIDE THE PROGRAM "AS IS" WITHOUT WARRANTY OF ANY KIND, EITHER EXPRESSED OR IMPLIED, INCLUDING, BUT NOT LIMITED TO, THE IMPLIED WARRANTIES OF MERCHANTABILITY AND FITNESS FOR A PARTICULAR PURPOSE. THE ENTIRE RISK AS TO THE QUALITY AND PERFORMANCE OF THE PROGRAM IS WITH YOU. SHOULD THE PROGRAM PROVE DEFECTIVE, YOU ASSUME THE COST OF ALL NECESSARY SERVICING, REPAIR OR CORRECTION.

12. IN NO EVENT UNLESS REQUIRED BY APPLICABLE LAW OR AGREED TO IN WRITING WILL ANY COPYRIGHT HOLDER, OR ANY OTHER PARTY WHO MAY MODIFY AND/OR REDISTRIBUTE THE PROGRAM AS PERMITTED ABOVE, BE LIABLE TO YOU FOR DAMAGES, INCLUDING ANY GENERAL, SPECIAL, INCIDENTAL OR CONSEQUENTIAL DAMAGES ARISING OUT OF THE USE OR INABILITY TO USE THE PROGRAM (INCLUDING BUT NOT LIMITED TO LOSS OF DATA OR DATA BEING RENDERED INACCURATE OR LOSSES SUSTAINED BY YOU OR THIRD PARTIES OR A FAILURE OF THE PROGRAM TO OPERATE WITH ANY OTHER PROGRAMS), EVEN IF SUCH HOLDER OR OTHER

PARTY HAS BEEN ADVISED OF THE POSSIBILITY OF SUCH DAMAGES.

END OF TERMS AND CONDITIONS

How to Apply These Terms to Your New Programs

If you develop a new program, and you want it to be of the greatest possible use to the public, the best way to achieve this is to make it free software which everyone can redistribute and change under these terms.

To do so, attach the following notices to the program. It is safest to attach them to the start of each source file to most effectively convey the exclusion of warranty; and each file should have at least the "copyright" line and a pointer to where the full notice is found.

one line to give the program's name and an idea of what it does.

Copyright (C) yyyy name of author

This program is free software; you can redistribute it and/or modify it under the terms of the GNU General Public License as published by the Free Software Foundation; either version 2 of the License, or (at your option) any later version.

This program is distributed in the hope that it will be useful, but WITHOUT ANY WARRANTY; without even the implied warranty of MERCHANTABILITY or FITNESS FOR A PARTICULAR PURPOSE. See the GNU General Public License for more details.

You should have received a copy of the GNU General Public License along with this program; if not, write to the Free Software

Foundation, Inc., 51 Franklin Street, Fifth Floor, Boston, MA 02110-1301, USA.

Also add information on how to contact you by electronic and paper mail.

If the program is interactive, make it output a short notice like this when it starts in an interactive mode:

Gnomovision version 69, Copyright (C) year name of author

Gnomovision comes with ABSOLUTELY NO WARRANTY; for details

type `show w'. This is free software, and you are welcome

to redistribute it under certain conditions; type `show c'

for details.

The hypothetical commands `show w' and `show c' should show the appropriate parts of the General Public License. Of course, the commands you use may be called something other than `show w' and `show c'; they could even be mouse-clicks or menu items--whatever suits your program.

You should also get your employer (if you work as a programmer) or your school, if any, to sign a "copyright disclaimer" for the program, if necessary. Here is a sample; alter the names:

Yoyodyne, Inc., hereby disclaims all copyright interest in the program `Gnomovision'

(which makes passes at compilers) written

by James Hacker.

signature of Ty Coon, 1 April 1989

Ty Coon, President of Vice

Dichiarazione di conformità

Noi, la Intenso GmbH,
con sede in Diepholzer Str. 15 a 49377 Vechta, Deutschland

dichiariamo su nostra responsabilità che il prodotto:

Modello: 7" Intenso TAB 734 (articolo n° 5509854)
Descrizione: Tablet computer

è conforme alle seguenti direttive e norme:

Direttiva R&TTE 1999/5/EG

- EN 301 489-1 V1.9.2
- EN 301 489-17 V2.1.1
- EN 300 328 V1.7.1 : 2006-10
- EN 55022:2010 (Class B)
- EN 55024:2010
- EN 61000-3-2:2006+A1 :2009+A2 :2009 (Class D)
- EN 61000-3-3:2008

Direttiva Bassa Tensione 2006/95/EG

- EN 60950-1:2006+A11:2009+A1:2010+A12:2011+A12:correzione 2012

Direttiva Ecodesign 2009/125/EG

- 1275/2008
- 278/2009

Direttiva ROHS 2011/65/EU

La documentazione tecnica riferita all'apparecchio sopra citato è stata depositata presso il seguente luogo:

Intenso GmbH
Diepholzer Str. 15, 49377 Vechta, Deutschland

Persona autorizzata:

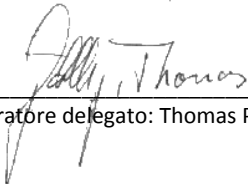

Amministratore delegato: Thomas Pöhlking

Mode d'emploi TAB 734

Merci d'avoir choisi **TAB734**. Suivez ces instructions pour connaître les fonctions clés de l'appareil.



1.) Contenu

1.) Contenu	1
2.) Remarques	2
3.) Aperçu de l'appareil	4
4.) Contenu de l'emballage	4
5.) Chargement de la batterie	5
6.) Utilisation d'une carte Micro SD / SDHC / SDXC	5
7.) Transmission de données entre l'appareil et un ordinateur	5
8.) Écran tactile	6
9.) WIFI	6
Connexion automatique	6
Connexion manuelle	7
10.) L'écran d'accueil	8
Affichage	8
Déverrouillage de l'écran	8
Barre d'état	9
Réglage de l'écran principal	10
Utiliser différents écrans d'accueil	10
Applications préinstallées sur l'écran d'accueil	11
11.) Aperçu des applications	11
12.) Expédition / réception des e-mails	12
Configuration de votre boîte aux lettres électronique	12
Gérer les comptes d'emails	13
Affichage des e-mails	13
Écrire des messages d'email	13
13.) Navigateur Web	14
Utilisation du clavier virtuel	14
Saisie de caractères spéciaux	14
Utilisation du navigateur Web	15
14.) Paramètres système	15
15.) Gestion des applications	17
Installation des applications	17
Désinstallation des applications	17
16.) Explorateur de fichiers	18
Naviguer à travers les fichiers et les dossiers	18
Utilisez la barre d'outils	18
Copier, déplacer et renommer des fichiers et dossiers	18
17.) Conditions de garantie limitée	19
18.) Données techniques	20
19.) Entretien de l'appareil	20
20.) Entretien de l'appareil	20
21.) Élimination des vieux équipements électroniques	20
20.) Licence information	21
Déclaration de conformité CE	25

Ce manuel ne contient peut-être pas toutes les fonctions de votre appareil. Pour utilisation des applications de fournisseurs tiers, veuillez contacter le fabricant. Veuillez noter que toutes les instructions peuvent être modifiées sans préavis. Vous trouverez des informations actuelles à l'adresse www.intenso.de

Marques

Google TM, le logo Google TM et Android TM sont des marques commerciales de Google Inc. Tous les autres noms de produits ou de services sont la propriété de leurs propriétaires respectifs.

2.) Remarques

- Éviter les chocs violents sur l'appareil. Ne pas le poser sur des surfaces inclinées afin d'éviter que l'appareil ne chute.
- Ne pas utiliser l'appareil dans des conditions extrêmement froides, chaudes, humides ou poussiéreuses. Ne pas exposer non-plus au rayonnement solaire direct.
- Éviter d'utiliser sur des endroits sablonneux.
- Ne pas utiliser dans des environnements présentant un risque d'explosion, comme par exemple aux pompes d'une station essence.
- Éviter l'utilisation de coussins, canapés ou autres objets qui favorisent un développement de la chaleur, car il y a un risque de surchauffe de l'appareil.
- Effectuer de fréquentes sauvegardes de données, pour éviter d'éventuelles pertes de données. Nous ne sommes pas responsables d'une perte de données éventuelle.
- Ne pas débrancher la connexion quand les données sont encours de transfert ou l'appareil en cours de formatage. Ceci peut entraîner la perte de données.
- Les images et les films peuvent être protégés des tiers par des droits. Écouter sans licence peut violer les droits d'auteur.
- Éviter l'utilisation dans des champs hautement magnétiques.
- Protéger l'appareil de l'humidité. Si l'humidité pénètre dans l'appareil, veuillez immédiatement l'éteindre, puis veuillez nettoyer et sécher l'appareil.
- Veuillez ne pas utiliser de solvants chimiques pour nettoyer l'appareil. Veuillez n'utilisez ici qu'un chiffon sec.
- Ne pas placer de flammes nues, telles que des bougies allumées, à proximité de l'appareil ou sur celui-ci.
- Nous ne sommes pas responsables des dommages en cas de fonctionnement défectueux, ni des pertes de données dues à une mauvaise manipulation, une réparation de l'appareil par vos propres moyens ou un changement de batterie.
- Si pour une fois l'appareil venait à ne pas répondre à vos entrées, veuillez utiliser le bouton de réinitialisation à l'arrière de l'appareil pour le faire redémarrer.
- Lorsqu'il n'est pas utilisé, veuillez débrancher l'adaptateur secteur de l'alimentation électrique.
- La prise doit se trouver dans les environs de l'appareil et être facilement accessible.
- N'utiliser l'adaptateur de courant que pour les prises reliées à la terre avec AC 100-240V~, 50/60 Hz Si vous n'êtes pas sûr de l'alimentation sur le lieu de montage, veuillez vous adresser à votre fournisseur d'énergie concerné.
- Veuillez utiliser uniquement l'adaptateur de courant et le câble de raccordement au réseau fournis.
- Pour interrompre l'alimentation de votre appareil, débranchez l'adaptateur secteur de la prise. Tenir fermement l'adaptateur secteur en vous déconnectant. Ne tirez jamais sur le câble

- Ne pas ouvrir le boîtier de l'adaptateur de courant. Lorsque le boîtier est ouvert, il existe un danger de mort par électrocution. Il ne contient aucune pièce réparable.
- Si elle n'est pas utilisée de façon prolongée, la batterie de l'appareil se décharge lentement. Avant d'être réutilisée, celle-ci doit à nouveau rechargée.
- Veuillez respecter l'élimination écologique de l'appareil ou de la batterie.
- Veuillez ne pas démonter l'appareil en pièces détachées et veuillez ne pas tenter de le réparer vous-même, la garantie expirant dans ce cas.
- Ne pas utiliser l'appareil dans des endroits où l'utilisation d'appareils mobiles est interdite. Ne pas utiliser l'appareil à proximité d'autres appareils électroniques, car cela peut entraîner des troubles dus aux signaux à haute fréquence.
- Ne pas utiliser l'appareil à proximité d'un stimulateur cardiaque, dans un hôpital ou à proximité d'équipement médical, car cela peut entraîner des troubles dus aux signaux à haute fréquence. Garder au moins 15cm de distance avec un stimulateur cardiaque. Veuillez contacter le fabricant de ces appareils pour recevoir des informations concernant l'utilisation commune.
- Lors de l'utilisation d'écouteurs ou de casque avec volume trop fort, l'ouïe peut être durablement endommagée. Nous vous prions de considérer qu'un volume constamment élevé peut causer des dommages auditifs permanents. Pour éviter un risque potentiel pour la santé causé par le volume trop élevé, nous vous recommandons d'utiliser les écouteurs inclus.
- Pour des raisons de sécurité routière, l'appareil ne peut pas être utilisé pendant la conduite par le conducteur lui-même.

3.) Aperçu de l'appareil

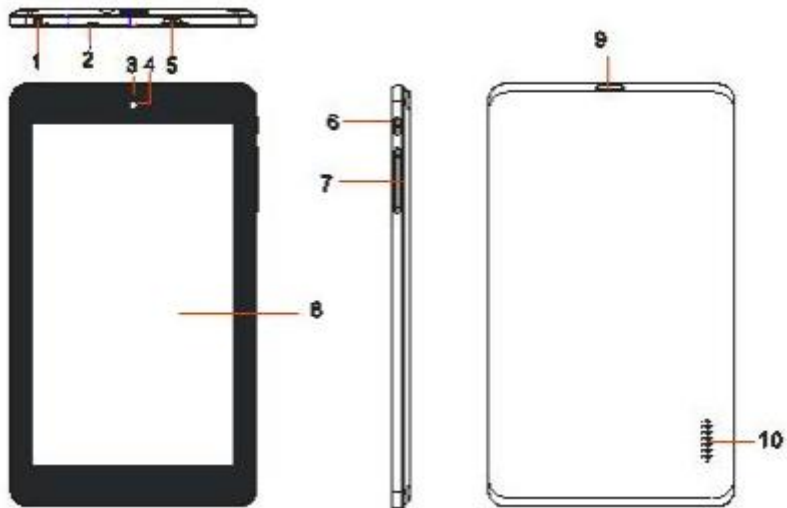

- (1) Prise casque de 3,5 mm
- (2) Microphone intégré
- (3) **Témoin de charge** : rouge lorsque le chargement est en cours – jaune lorsque le chargement est complet.
- (4) **Caméra frontale**
- (5) **Emplacement Micro USB**

- (6) **Touche On / Off** : Appuyez longuement pour mettre l'appareil hors tension, appuyez brièvement pour alterner entre le mode veille et actif.
- (7) **Volume + / -**
- (8) **Touchscreen**
- (9) **Emplacement carte Micro SD**
- (10) **Haut-parleur intégré**

4.) Contenu de l'emballage

Veillez **vérifier** l'intégralité du **contenu de l'emballage** :

- TAB 734
- Câble USB
- Adaptateur secteur 5V 1.2A
- Manuel d'utilisation

5.) Chargement de la batterie

Veillez **charger** la **batterie complètement avant la première utilisation** de l'appareil. **Pour cela, connectez l'adaptateur secteur fourni à l'appareil** et à une **prise de courant**. La **charge complète** prend environ **5 heures**. L'**état de charge** est affiché sur le **côté avant droit** de l'appareil. La **LED est rouge pendant la charge** et **passse au jaune** lorsque la **batterie est complètement chargée**.

Remarques :

- a. A 15% de la puissance résiduelle de la batterie, vous obtenez un message d'avertissement sur l'écran. Vous devriez maintenant connecter l'appareil au secteur avec une prise pour charger la batterie afin d'éviter d'éventuelles pertes de données et augmenter la durée de vie de la batterie.
 - b. Vous pouvez utiliser l'appareil pendant le chargement de la batterie. Pour garantir à la batterie une longue durée de vie, nous vous demandons de ne pas utiliser l'appareil.
 - c. Pour assurer une bonne performance, la batterie intégrée doit être utilisée fréquemment. Si vous n'utilisez l'appareil que rarement, veuillez recharger la batterie complètement au moins une fois par mois.
 - d. Assurez-vous de n'utiliser que l'adaptateur secteur fourni pour le chargement.
-

6.) Utilisation d'une carte Micro SD / SDHC / SDXC

Cet appareil peut lire des données **directement** à partir d'une carte **micro SD/SDHC/SDXC** d'une **capacité maximale de 64 GB**. Pour utiliser une carte **micro SD/SDHC/SDXC**, veuillez insérer la carte dans le port micro SD prévu à cet effet situé sur le **côté gauche de l'appareil**. Utilisez l'**explorateur préinstallé** pour accéder aux **données** se trouvant sur la **carte mémoire**. Pour ce faire, veuillez sélectionner le **dossier « Carte SD »** dans l'**explorateur**.

7.) Transmission de données entre l'appareil et un ordinateur

- 1.) Branchez l'**appareil** à un ordinateur en utilisant le **câble USB** ci-joint.
- 2.) L'**écran** pour la **connexion USB** s'affiche à présent sur l'appareil. Tapez **brèvement** sur **«Activer la mémoire USB»**. L'appareil est reconnu **comme support de données amovible** et vous obtenez l'information **«mémoire USB en utilisation»**. Après avoir **brèvement** tapé sur la **touche Accueil**, vous pouvez **continuer à utiliser** votre appareil **normalement**. Vous avez maintenant accès **aux données internes de votre appareil depuis votre ordinateur** et vous pouvez copier, supprimer ou déplacer des données sur l'appareil.
- 3.) Si une connexion USB avec l'ordinateur existe, l'icône USB s'affiche dans la barre d'état. Vous pouvez obtenir des informations supplémentaires dans la barre d'état élargie et vous pouvez activer ou désactiver la connexion USB.
 - Sélectionnez **« Désactiver le disque USB »** pour **désactiver** le disque.
 - Sélectionnez la **fonction « Retirer en toute sécurité »**  sur l'ordinateur pour **retirer le périphérique de l'ordinateur**.

Note : Les applications préinstallées et le système d'exploitation Android™ prennent une partie de la mémoire interne existante..Pour cette raison, toute la mémoire interne n'est pas disponible.

8.) Écran tactile



Ce périphérique est actionné via l'**écran tactile**. Vous pouvez facilement lancer des **applications** en **appuyant** sur l'**écran tactile** avec vos **doigts**, **saisir des textes sur le clavier virtuel** et basculer entre les **différents écrans principaux** en **faisant glisser le doigt dans la direction respective**.

Veuillez **retirer le film de protection de l'écran** avant **d'utiliser** l'appareil.

L'écran **tactile** détecte de petites **charges électriques**, comme celles émises par les doigts humains et **détermine** ainsi le **point d'entrée**. Utilisez alors idéalement le **bout de vos doigts** pour l'**entrée**. L'opération avec **un stylo ou d'autres objets pointus** n'est pas possible.

L'**écran tactile** ne doit **pas entrer en contact** avec l'eau ou d'autres appareils électriques afin d'éviter des **dysfonctionnements** et des **défauts durables**.

Remarques :

- a. Si l'écran tactile n'est pas exploité pendant deux minutes, l'appareil passe en mode veille. Appuyez brièvement sur la touche ON / OFF pour passer en mode actif.
 - b. Pour empêcher des entrées non autorisées, un mode verrouillage est activé automatiquement. Veuillez déverrouiller le mode verrouillage sur l'écran tactile. Touchez le verrou fermé  sur l'écran et maintenez appuyé. Maintenant faites glissez le verrou vers le verrou ouvert  qui apparaît sur l'écran et retirez votre doigt de l'écran. L'écran est maintenant déverrouillé.
-

Vous pouvez faire pivoter l'appareil dans **toutes les directions**. Il possède un **capteur** qui **dirige l'écran automatiquement**.

9.) WIFI

Vous avez besoin d'une **connexion WLAN** pour connecter l'appareil à **Internet**. Ouvrez les **paramètres WLAN** dans le **menu des réglages** activez-la.

Note : Veuillez noter qu'un réseau sans fil doit se trouver à portée de votre emplacement actuel.

Connexion automatique

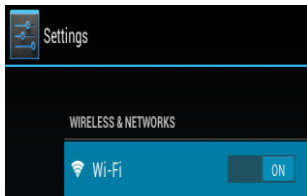

Ouvrez les paramètres **WLAN** via le **menu des paramètres**. Ici, vous pouvez tout simplement **activer** ou **désactiver** la **fonction WLAN**. Il suffit de faire glisser le **commutateur virtuel** de la **position «On»** vers la gauche pour **désactiver** la fonction WLAN. Maintenant, l'affichage **change** sur "OFF". Pour **réactiver la fonction WLAN désactivée**, faites glisser le **commutateur virtuel** vers la droite.

Sur le côté droit des paramètres **WIFI**, **tous les réseaux disponibles** ainsi que **tous les réseaux déjà utilisés** sont affichés.

Veuillez taper sur le **réseau désiré** et si nécessaire, entrez la **clé sans fil** appropriée (mot de passe) pour **établir une connexion**.

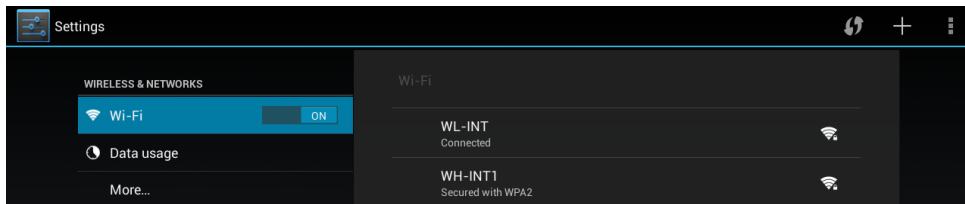

Confirmez le mot de passe saisi, au besoin, en touchant la **touche entrer** et ensuite sélectionnez **Connexion**. Après un **bref instant** la **connexion sera établie**.

Remarques :

- a) Si l'appareil passe en mode veille, la Wi-Fi est automatiquement désactivée. Cela réduit la consommation d'énergie et entraîne donc automatiquement une plus grande autonomie de la batterie. Lorsque l'appareil revient au mode actif, la connexion sans fil est à nouveau établie automatiquement. Cela peut prendre quelques secondes.
 - b) La liste des réseaux sans fil repérables est automatiquement mise à jour.
 - c) Si la fonction sans fil est activée, l'appareil se connecte automatiquement à un réseau déjà configuré, à condition qu'il soit à portée.
 - d) Si un réseau sans fil inconnu se trouve à portée, une boîte d'information apparaît.
-

Connexion manuelle

Afin de rechercher un **réseau WiFi accessible manuellement**, procédez comme suit :



- (1) Ouvrez les **paramètres**.
- (2) Maintenant, ouvrez les **paramètres WLAN** et appuyez sur les trois points dans le coin supérieur droit, puis sélectionnez "**Analyse**".
- (3) Si le réseau WiFi ne figure **pas** dans la **liste des réseaux disponibles** alors sélectionnez l'option « **Ajouter un réseau** » afin de saisir le **SSID du réseau**, le **protocole de sécurité** et le **mot de passe** possiblement lié. Appuyez sur « **Enregistrer** » pour **confirmer** votre **saisie**.

10.) L'écran d'accueil

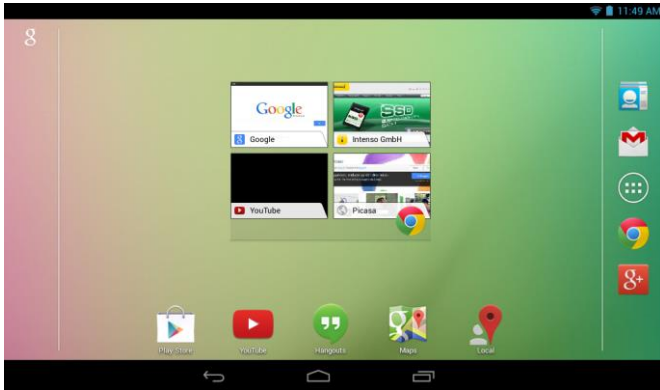
Affichage



Déverrouillage de l'écran

Si l'écran tactile **n'est pas utilisé pendant deux minutes**, l'appareil se met en mode **Standby**. Appuyez sur le **bouton « Marche/Arrêt »** pendant une courte période pour revenir en **mode actif**. L'**affichage verrouillé empêche les saisies involontaires**. Touchez le **verrou fermé**  sur l'écran et maintenez **appuyé**. **Maintenant faites glisser le verrou vers le verrou ouvert**  qui apparaît sur l'écran et **retirez votre doigt de l'écran**. L'écran est maintenant **déverrouillé**.

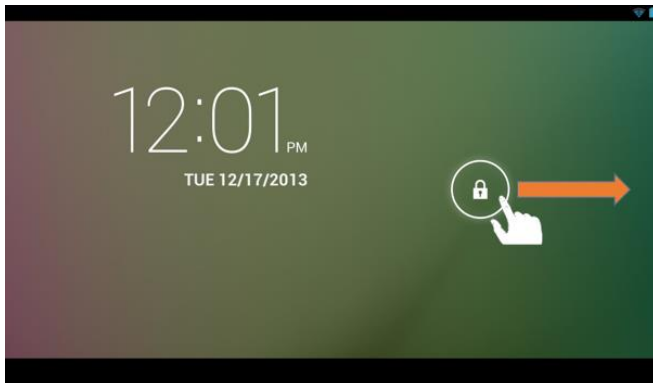

Déplacer l'icône de verrouillage avec votre doigt dans le sens de la flèche.

Conseil : Faites glisser le symbole du verrou vers le **symbole d'appareil photo** qui apparaît pour ouvrir **l'application appareil-photo directement**.

Barre d'état

Vous trouverez la **barre d'état** dans les parties **supérieure** et **inférieure** de l'écran de départ.

La **barre d'état supérieure** est divisée en **deux sections**. Tirez la barre de **gauche** vers le bas pour faire apparaître, si disponibles, les **notifications actuelles**.

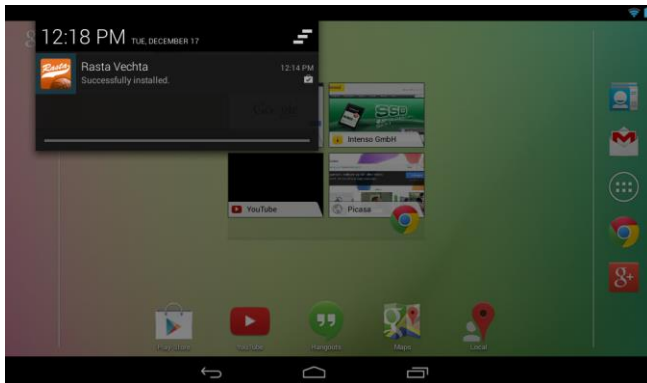

Tirez la barre de **droite** vers le bas pour faire apparaître le **champ d'accès rapide** pour **différents paramètres**.

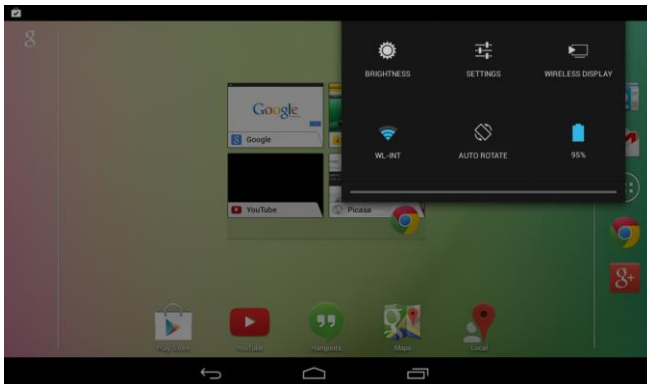

La **barre d'état inférieure** vous offre la possibilité de passer à l'écran précédent, de **cacher** le **clavier** qui apparaît à l'écran, d'**atteindre** directement l'écran de départ, d'obtenir une liste des **programmes récemment utilisés** et d'**ajuster** le **volume**.



Réglage de l'écran principal

Vous pouvez régler l'**écran principal** facilement selon vos **besoins particuliers**. Si vous souhaitez **supprimer une icône**, appuyez sur l'**icône** avec le **doigt** pendant une **courte période**, puis **poussez-la** dans l'**icône X** affichée. Maintenant, retirez votre **doigt de l'écran tactile** et l'**icône est supprimée**.

Si vous souhaitez déplacer une **icône de l'aperçu des applications vers l'écran principal**, appuyez sur l'**icône** dans l'**aperçu des applications** pendant une **courte période** et l'**écran principal** s'affiche. **Déplacez l'icône** vers la **position désirée** et retirez votre **doigt de l'écran tactile**. L'**icône** est désormais **ajoutée** à l'écran principal. Si vous déplacez une icône sur une autre icône, un dossier contenant les deux icônes est automatiquement créé. Appuyez sur le dossier pour afficher les icônes contenues puis sélectionnez l'icône souhaitée en tapant brièvement dessus.

Vous pouvez également ajouter **des widgets à l'écran de démarrage**. Pour ce faire, ouvrez la **présentation de l'application**. Ensuite, vous tapez le mot **Widgets**. Tous les **widgets disponibles sur l'appareil** s'afficheront. **Vous ajoutez un widget à l'écran de démarrage** de la même manière que vous ajoutez une icône.

Si vous voulez changer votre image de fond, appuyez simplement sur une place libre dans l'écran principal et continuez à appuyer sur l'écran jusqu'à ce que le menu de sélection d'arrière plan apparaisse.

Utiliser différents écrans d'accueil

Cinq **écrans principaux peuvent être individuellement configurés**. Vous pouvez facilement passer de l'un à l'autre en **faisant glisser** le doigt **légèrement** sur l'écran vers la **gauche ou la droite**.

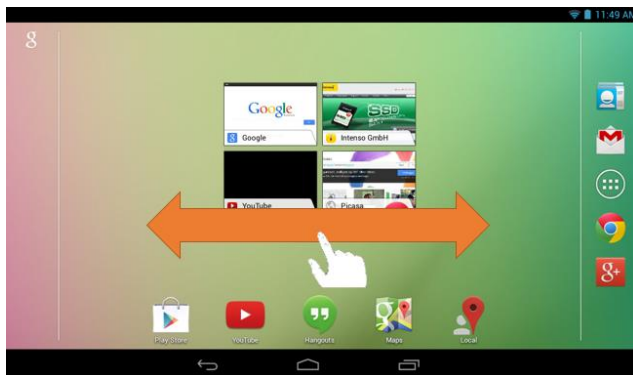

En appuyant sur la touche accueil, vous arrivez toujours à revenir à l'écran d'accueil central.

Applications préinstallées sur l'écran d'accueil

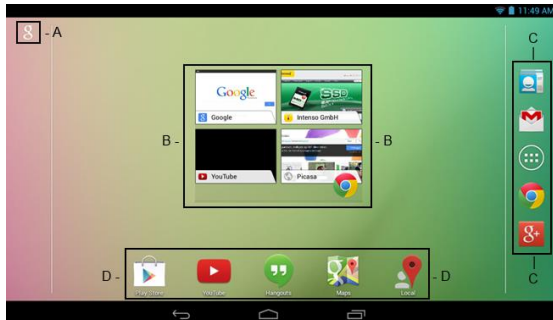

- A Lien vers Google™ search
- B Bookmark Aperçu pour le navigateur Chrome™
- C Contacts, Gmail™, Aperçu des applications, Chrome™ et Google+™
- D Google Play Store™, YouTube™, Hangouts™, Maps™ et Local™

11.) Aperçu des applications



Tapez **brèvement** sur l'**icône Aperçu des applications** pour ouvrir l'**aperçu des applications**. Vous voyez maintenant un **aperçu** de toutes les **applications pré-installées** et des **applications** que vous avez déjà **installées**. Ouvrez l'**application souhaitée** en tapant **brèvement** sur l'**icône** correspondante.

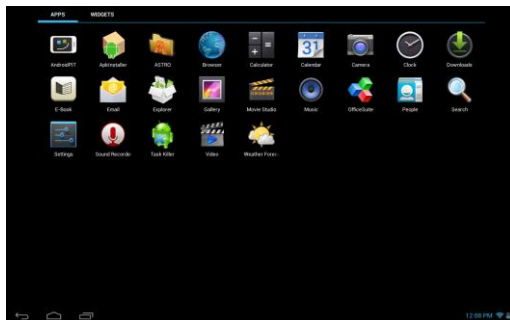

Aperçu des applications

12.) Expédition / réception des e-mails

Une **application de messagerie électronique** est préinstallée sur cet appareil. Vous pouvez ainsi utiliser **votre** adresse e-mail **existante pour envoyer et recevoir des e-mails**.

Note : Pour cette fonction, une connexion internet sans fil est nécessaire.

Ouvrez l'application par l'intermédiaire de l'icône «**E-mail**» que vous trouvez dans le **menu des applications**.

Configuration de votre boîte aux lettres électronique

- (1) **Démarrez** l'application e-mail en **tapant** sur l'icône **e-mail**. Vous êtes maintenant invité à mettre en place votre **boîte aux lettres électroniques**.
- (2) Entrez votre adresse e-mail et votre mot de passe associé, puis tapez sur «**Suivant**». Ensuite, renommez votre compte et définissez votre nom affiché pour les messages sortants. Tapez sur «**Terminé**» pour terminer l'installation. Votre boîte aux lettres électronique est sélectionnée comme boîte par défaut si vous sélectionnez l'option «**Envoyer des e-mails de ce compte par défaut**».
- (3) Vous pouvez également configurer votre **boîte aux lettres électronique manuellement**. Entrez votre **adresse e-mail** et **votre mot de passe associé**, puis tapez sur «**Configuration manuelle**» pour saisir les **informations du serveur e-mail**.
- (4) **Choisissez** parmi les **types de serveurs POP3, IMAP ou Exchange** pour e-mails entrants.

Note : Si vous ne savez pas quels paramètres que vous devez effectuer, veuillez contacter votre fournisseur de messagerie électronique, votre administrateur réseau ou recherchez sur internet des termes tels que «**adresse POP**» et «**nom de votre fournisseur**» selon les informations requises.



- (5) Entrez les **informations** requises (serveur, port, etc.)
- (6) Sélectionnez le **type de serveur** pour les **e-mails sortants** et entrez les **informations requises**.
- (7) Tapez sur «**Suivant**» pour **poursuivre** dans le **menu**. L'application e-mail **vérifie à présent les modifications apportées à la configuration du serveur**. Après avoir réussi à créer un dossier, vous voyez le message «**Votre compte est créé, et l'e-mail est en cours de création**». Votre compte est maintenant **mis en place**.
- (8) Entrez un **nom** pour **votre** boîte aux lettres, puis tapez sur «**Terminé**» pour **terminer** le processus.

Note : Si vous deviez posséder plus d'un compte e-mail, le compte par défaut est appelé lors de chaque démarrage de l'application e-mail.

Gérer les comptes d'emails

Ajouter une nouvelle boîte de réception:

- (1) Ouvrez l'**application email** et appuyez sur la **touche menu** **E** pour afficher des **options supplémentaires**. Sélectionnez l'option de menu « **Paramètres** » puis « **Ajouter un compte** » pour créer une nouvelle **boîte aux lettres**.
- (2) Suivez les instructions de l'**Assistant Installation** pour **créer** une **nouvelle boîte aux lettres**

Supprimer une boîte de réception:

- (1) Ouvrez l'**application email** et appuyez sur la **touche menu** **E** pour afficher des **options supplémentaires**. Sélectionnez l'option de menu « **Paramètres** » puis « **Supprimer un compte** » pour supprimer une la **boîte aux lettres** désirée.

Vérifier les propriétés du compte:

- (1) Ouvrez l'**application email** et appuyez sur la **touche menu** **E** pour afficher des **options supplémentaires**, puis sélectionnez « **Paramètres** ». **Toutes les boîtes aux lettres déjà créées** s'affichent alors sur le côté gauche du menu.
- (2) Appuyez sur la **boîte aux lettres souhaitée** pour afficher les paramètres du compte
- (3) Appuyez sur « **Paramètres du Compte** » que vous souhaitez modifier dans le but de **faire les saisies souhaitées**.

Affichage des e-mails

Ouvrez l'application e-mail en **tapant brièvement** sur l'icône e-mail. Votre **boîte aux lettres déjà créée s'affiche à présent**.

- Par un **mouvement de balayage vertical**, vous pouvez faire **défiler** vos e-mails.
- **Tapez** brièvement sur un **e-mail spécifique** pour **ouvrir celui-ci**.
- Tapez et **maintenez votre** doigt **sur un e-mail particulier afin** d'afficher **plus d'options**. Un **champ d'information** apparaît à présent. Vous pouvez maintenant **ouvrir l'e-mail, y répondre, le transférer** ou le **supprimer**.

Ecrire des messages d'email

- (1) Appuyez sur l'**icône email** dans la **barre de menu** en haut de l'aperçu email et une **nouvelle fenêtre** s'ouvre, où vous pouvez **écrire un nouveau message**.
- (2) Saisissez l'**adresse électronique du destinataire**, une **ligne d'objet** et le **texte** dans les **champs désignés**. Vous pouvez également ajouter « **Cc / Cci** » pour envoyer cet e-mail à plusieurs utilisateurs.
- (3) Appuyez sur **Envoyer** pour envoyer l'**email**. Appuyez sur « **Enregistrer** » pour sauvegarder l'**email saisi en tant que brouillon**. Lorsque vous appuyez sur l'**icône « pouvelle »**, l'**email actuellement saisi sera supprimé**.

13.) Navigateur Web

Pour lancer le **navigateur Web**, veuillez taper sur l'icône **navigateur**  **de l'écran d'accueil**. Pour ouvrir **une** page Web, veuillez taper sur le champ de saisie **supérieur** pour l'adresse internet. Le **clavier virtuel** s'ouvre à présent et vous pouvez entrer l'**adresse** du **site web désiré**. Tapez sur **«Go»** ou sur l'**icône de flèche** **près du champ de saisie** pour ouvrir la page web.

Note : *Tous les réseaux ne fournissent pas un accès Internet. Certains réseaux offrent un accès uniquement à d'autres ordinateurs connectés localement et aucune connexion Internet.*

Utilisation du clavier virtuel

Tapez sur le **champ de saisie** pour ouvrir le **clavier virtuel**. Vous pouvez maintenant **saisir du texte** ou **appeler des pages Internet**.



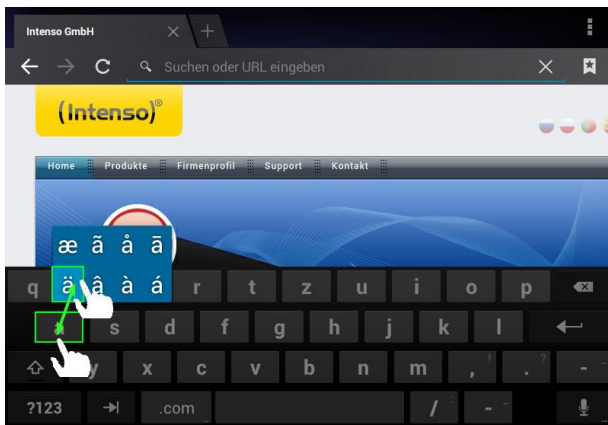

- Caps Lock (Écriture en majuscule et en minuscule)
- Touche de retour en arrière
- Appel du menu pour entrer les nombres, caractères et caractères spéciaux
- Barre d'espace (Entrée d'espace)
- Entrée (confirmation de votre entrée)

Pour saisir un **caractère spécial** tel que « ä », appuyez sur la touche « a » avec votre **doigt** pendant **une longue période** pour appeler le menu des **caractères spéciaux**. Maintenant glisser avec votre doigt sur le caractère spécial souhaité, par exemple un « ä » et retirez votre doigt de l'écran. Vous avez maintenant saisi un « ä ».





Utilisation du navigateur Web

- Vous pouvez faire défiler **l'affichage à l'écran** en effectuant un **mouvement de balayage vertical** avec vos **doigts**. Veuillez ne pas **amorcer** le mouvement de balayage sur un **élément de menu** ou un **lien**, sinon **l'opération existante** serait ouverte.
- Pour ouvrir un **lien Internet**, tapez simplement sur le **lien**. La nouvelle **page** s'ouvre **automatiquement**.
- Appuyez sur la **touche menu**  pour ouvrir le **menu du navigateur Web**. Là, de **multiples fonctions** sont fournies. Parmi d'autres choses pouvez **actualiser le site Web ouvert ici**, multiples **Webs**.
- Pour **revenir** à la page **précédente**, veuillez appuyer sur la **touche retour** .
- Pour aller **directement à l'écran d'accueil**, veuillez appuyer sur la **touche Accueil** .
- Pour entrer du **texte**, tapez sur le **champ approprié** et utilisez le **clavier virtuel pour saisir du texte**.

Note : Pour cette fonction, une connexion Internet sans fil est nécessaire.

14.) Paramètres système

Appuyez sur l'**icône** des **paramètres** dans le **menu des applications** pour appeler les **paramètres système**.

- Vous pouvez trouver les **différentes catégories** sur le **côté gauche du menu**. Les **options de configuration disponibles** sont affichées en **appuyant brièvement** sur chaque **option de menu sélectionnée**. Notez que toutes les **fonctions offertes** par Android™ ne sont peut-être pas compatibles avec l'appareil.
- Lorsque vous avez réglé **tous les paramètres** vous pouvez revenir au **menu précédent** avec la **touche Retour** , ou passer à l'**écran principal** directement avec la **touche Accueil** . Vos **saisies** seront **automatiquement enregistrées**.

Présentation de la configuration des réglages principaux

WiFi & Réseaux	WiFi	Ici vous pouvez régler les paramètres WiFi.
	Plus	Ici vous pouvez régler des paramètres réseau supplémentaires.
Périphérique	Sons	Spécifiez le volume désiré et le son pour les messages ici. Vous pouvez aussi activer ou désactiver un son de confirmation lorsque vous touchez l'écran et un son indicatif lors du déverrouillage de la serrure d'affichage.
	Affchage	Luminosité – Régler la luminosité de l'écran. Fond d'écran – Sélection du fond d'écran. Mode veille state – Réglez le délai avant la désactivation automatique de l'affichage. Taille de la police – configuration de la taille de police souhaitée.
	Mémoire	Ici, vous pouvez obtenir des informations sur la mémoire interne et - si elle est insérée - sur votre carte MicroSD. Vous pouvez aussi supprimer le contenu de la mémoire.
	Batterie	Ici, vous pouvez obtenir des informations sur l'état de charge des batteries intégrées..
	Apps	ci vous pouvez gérer les applications installées et d'obtenir des renseignements à leur sujet.
	Utilisateur	Localisation de services
	Sécurité	Ici vous pouvez mettre en place un verrouillage de l'écran, par exemple, ou la mise en œuvre d'autres paramètres de sécurité.
	Langue & Clavier	Ici vous pouvez définir votre langue préférée, par exemple, ou ajouter des mots différents à votre dictionnaire personnel ou régler le clavier.
	Enregistrer & réinitialiser	Ici, vous pouvez enregistrer vos paramètres système et données d'application sur les serveurs Google™. De plus vous pouvez réinitialiser les réglages par défaut. ATTENTION : Ce faisant, toutes les données sauvegardées sur le périphérique seront supprimées.
Comptes	Ajouter un compte	Permet l'ajout de différents comptes.
Système	Date & heure	Ici vous pouvez définir la date, l'heure, le fuseau horaire et le format d'affichage.
	A propos de la tablette	Affiche des informations supplémentaires sur le périphérique.

15.) Gestion des applications

Applications préinstallées

Cet appareil est livré avec des **applications** déjà préinstallées. Vous trouverez un **aperçu** des **applications** déjà installées dans l'**aperçu des applications** . Pour **ouvrir** une de ces **applications**, tapez brièvement sur l'**icône** correspondante.

Installation des applications

Pour **installer des applications** sur l'appareil, veuillez effectuer les opérations **suyvantes** :

- (1) Ouvrez la source **désirée pour le téléchargement des applications**, par exemple **Google Playstore** TM préinstallée. Pour ce faire, vous devez d'abord vous connecter avec votre compte **Playstore** TM **existant** ou créer un **nouveau compte Playstore** TM. Il suffit de suivre les **instructions à l'écran**.
- (2) Après **vous être connecté**, un grand **choix d'applications Google Playstore** TM vous sera disponible. Sélectionnez **l'application souhaitée**, appuyez sur **installer** et éventuellement **confirmer l'autorisation d'accès** pour cette application. Le **téléchargement** va commencer maintenant et la **progression** s'affiche dans le coin supérieur gauche de la **barre d'état** avancée.
- (3) Après avoir **téléchargé** l'application, elle est automatiquement **installée**. Vous trouverez la nouvelle **application** dans le **menu des applications** après sont installation. Vous pouvez voir la **progression de l'installation** dans le coin supérieur gauche de la **barre d'état** avancée.

Désinstallation des applications





- (1) Ouvrez les **paramètres système** en appuyant sur **l'icône des paramètres** dans l'aperçu d'application.
- (2) Maintenant, appuyez sur l'option de menu « **Apps** » brièvement pour accéder aux **paramètres d'applications**.
- (3) Choisissez l'aperçu d'applications souhaité dans les options de menu « **Télécharger, mémoire, active et tous** » en **tapant brièvement dessus**.
- (4) Maintenant, sélectionnez **l'application** que vous souhaitez désinstaller en **tapant brièvement dessus**.
- (5) Maintenant, appuyez sur « **Désinstallez** » et **validez** votre entrée avec **OK** pour désinstaller **l'application du périphérique**.

Note : Vous ne pouvez pas supprimer les logiciels préinstallés.

16.) Explorateur de fichiers

Ouvrez l'**aperçu des applications**, puis tapez brièvement sur l'**icône Explorateur** pour démarrer le **fichier Explorateur**.

Naviguer à travers les fichiers et les dossiers

- Vous pouvez choisir entre la **mémoire interne** (internal Memory), la **carte mémoire** (SD Card) et **USB**. Tapez sur l'**emplacement d'enregistrement voulu** afin d'afficher les **fichiers qu'il contient** sous forme de **liste**. Si **aucune carte mémoire** n'était insérée ou qu'**aucun dispositif de stockage n'était connecté via la connexion USB**, vous en êtes informé par «... **est démonté**».
- Avec un **mouvement vertical de balayage**, vous pouvez maintenant **faire défiler** vos fichiers et **dossiers**. Ouvrez un **fichier** ou un **dossier** en tapant **brièvement**.
- Vous pouvez faire basculer en avant  **ou en arrière**  en tapant brièvement sur les **icônes** correspondantes.
- Pour parvenir à un **niveau plus haut** dans la **structure** du **fichier**, tapez brièvement sur l'**icône LevelUp** .
- Avec l'**icône Accueil**,  aller **directement** dans le **répertoire principal**.

Utilisez la barre d'outils





Appuyez sur la **touche Menu** , puis « Masquer la barre d'outils » afin de faire apparaître ou disparaître la barre d'outils.

Accueil	Aller directement dans le répertoire principal.
LevelUp	Aller à un niveau supérieur.
Multi	Sélectionner plusieurs fichiers.
Editeur	Copier, déplacer, supprimer, insérer ou renommer un fichier ou un dossier.
Nouveau dossier	Créer un nouveau dossier.
Retour	Une étape en arrière.
Suivant	Une étape en avant.

Copier, déplacer et renommer des fichiers et dossiers

- 1.) **Accédez** au **fichier souhaité** dans l'**aperçu des fichiers**.
- 2.) Tapez et maintenez votre doigt sur le fichier jusqu'à ce qu'un champ d'information apparaisse.
- 3.) Maintenant, sélectionnez la **fonction désirée**. Vous avez le choix entre **Copier** (Copy), **Supprimer** (Delete), **Déplacer** (Move), **Coller** (Paste) - pour cela, un fichier doit se trouver dans le **presse-papiers** - et **Renommer** (Rename).
- 4.) Pour **copier** ou **Déplacer**, tapez brièvement sur l'**icône appropriée** **icône** (Copy / Move) et **navigatez** ensuite dans le **répertoire de destination**. Tapez ensuite sur l'**icône Editeur**  et sélectionnez «**Coller**» en tapant **brièvement** pour **insérer le fichier**.

- 5.) Pour **supprimer** un **fichier**, tapez sur «**Supprimer**» et **confirmez** à nouveau avec «**Supprimer**» **pour la sécurité**. Pour **annuler**, tapez **brèvement** sur «**Annuler**».
- 6.) Pour **renommer** un **fichier**, tapez sur «**Renommer**», puis entrez le **nouveau nom de fichier sur le clavier virtuel**. **Confirmez** votre **entrée** avec «**OK**» ou annuler la **procédure** avec «**Annuler**».
- 7.) Vous pouvez **copier, supprimer ou déplacer simultanément plusieurs fichiers et dossiers**. Pour cela, tapez sur l'**icône Multi**  puis sur les **fichiers souhaités**. Les **fichiers marqués** s'affichent maintenant dans une **autre couleur**. Tapez sur l'icône **Editeur**  pour effectuer **l'action souhaitée**.

17.) Conditions de garantie limitée

La garantie couvre uniquement le remplacement de ce produit Intenso. La garantie ne couvre pas l'usure normale résultant d'une mauvaise, d'une inappropriée, d'une négligence, d'un accident, d'une incompatibilité ou d'une mauvaise performance d'un matériel informatique ou de logiciels informatiques définis.

Il n'y a aucun bénéfice de la garantie en cas de non-respect du manuel utilisateur Intenso ainsi qu'en cas de mauvaise installation, utilisation, ou en cas de défauts causés par d'autres équipements.

Si l'appareil est exposé à des vibrations, des décharges électrostatiques, aux effets de la chaleur ou de l'humidité au-delà des spécifications du produit, il n'est plus garanti.

Intenso n'est pas responsable des pertes de données ou de la survenue de tout autre dommage collatéral ou dommage consécutif, de la violation des conditions de garantie ou de tout autre dommage, quelle qu'en soit la cause sous-jacente.

Ce produit n'est pas destiné à un usage commercial ni à des applications médicales et spéciales dans laquelle la défaillance du produit peut entraîner des blessures, la mort ou des dommages matériels considérables.

18.) Données techniques

CPU	1.0 GHz Dualcore based on Cortex A9
Mémoire principale	1 Go de DDR 3
Système d'exploitation	Android 4.2.2
Systèmes d'exploitation compatibles	Windows XP / Vista / 7 / 8 / Linux 2.4 et ultérieur / Mac 10.6 et supérieur
Options de connexion	Casque, Micro SD (SDHC/SDXC), micro USB
Sans fil	WiFi (802.11 b / g / n)
Gyroscope 3 axes	Rotation de 360 degrés
Format photo	JPEG, BMP, GIF, PNG
Format audio	MP3, WMA, WAV, OGG, FLAC, APE
Format vidéo	MPEG1, MPEG 4, FLV
Affichage	Écran TFT LCD, 1024 x 600 pixels
Caméra	Caméra frontale 0,3 MP
SNR	> = 80 dB
Gamme de fréquence	20 Hz - 20 KHz
Alimentation	(V) AC Adapter (HUONIO HNBC050120UE): AC Input 100-240V~50/60Hz, DC Output 5V / 1.2A
Batterie interne	Batterie lithium ion et polymère rechargeable

19.) Entretien de l'appareil

Ne pulvérisez ou n'appliquez jamais un liquide directement sur l'écran ou le boîtier.

20.) Entretien de l'appareil

Essayez délicatement le boîtier, le cadre et l'écran avec un chiffon doux, non pelucheux et sans produit chimique. N'utiliser que des détergents spécialement conçus pour les écrans.

21.) Élimination des vieux équipements électroniques

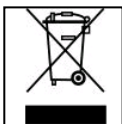

Les équipements marqués avec ce symbole sont soumis à la directive européenne 2002/96/EC.

Tous les appareils électriques et les déchets d'équipement électroniques et électriques doivent être éliminés séparément des ordures ménagères en utilisant les lieux prévus par l'état à cet effet. Éviter d'endommager l'environnement en éliminant les vieux équipements électroniques.

(Intenso)[®]

49377 Vechta
Germany
www.intenso.de



20.) Licence information

Notice of GNU GENERAL PUBLIC LICENSE and LESSER GENERAL PUBLIC LICENCE

Dear Customer,

If interested, you and any third party can download the source code of used GPL / LGPL from Intenso Webpage <http://www.intenso.de> . The source code of the desired product is available to anyone on the selection of valid product category and the desired device. In the product details you will find the entry "drivers". Open this menu to download the corresponding GPL / LGPL code. For a fee of 35 € (delivery to another country as Germany), it is also possible to obtain this code by postal delivery. More information about the GPL/LGPL-Licence can you find on following website www.gnu.org

GNU GENERAL PUBLIC LICENSE

Version 2, June 1991

Copyright (C) 1989, 1991 Free Software Foundation, Inc.

51 Franklin Street, Fifth Floor, Boston, MA 02110-1301, USA

Everyone is permitted to copy and distribute verbatim copies of this license document, but changing it is not allowed.

Preamble

The licenses for most software are designed to take away your freedom to share and change it. By contrast, the GNU General Public License is intended to guarantee your freedom to share and change free software--to make sure the software is free for all its users. This General Public License applies to most of the Free Software Foundation's software and to any other program whose authors commit to using it. (Some other Free Software Foundation software is covered by the GNU Lesser General Public License instead.) You can apply it to your programs, too.

When we speak of free software, we are referring to freedom, not price. Our General Public Licenses are designed to make sure that you have the freedom to distribute copies of free software (and charge for this service if you wish), that you receive source code or can get it if you want it, that you can change the software or use pieces of it in new free programs; and that you know you can do these things.

To protect your rights, we need to make restrictions that forbid anyone to deny you these rights or to ask you to surrender the rights. These restrictions translate to certain responsibilities for you if you distribute copies of the software, or if you modify it.

For example, if you distribute copies of such a program, whether gratis or for a fee, you must give the recipients all the rights that you have. You must make sure that they, too, receive or can get the source code. And you must show them these terms so they know their rights.

We protect your rights with two steps: (1) copyright the software, and (2) offer you this license which gives you legal permission to copy, distribute and/or modify the software.

Also, for each author's protection and ours, we want to make certain that everyone understands that there is no warranty for this free software. If the software is modified by someone else and passed on, we want its recipients to know that what they have is not the original, so that any problems introduced by others will not reflect on the original authors' reputations.

Finally, any free program is threatened constantly by software patents. We wish to avoid the danger that redistributors of a free program will individually obtain patent licenses, in effect making the program proprietary. To prevent this, we have made it clear that any patent must be licensed for everyone's free use or not licensed at all.

The precise terms and conditions for copying, distribution and modification follow.

TERMS AND CONDITIONS FOR COPYING, DISTRIBUTION AND MODIFICATION

0. This License applies to any program or other work which contains a notice placed by the copyright holder saying it may be distributed under the terms of this General Public License. The "Program", below, refers to any such program or work, and a "work based on the Program" means either the Program or any derivative work under copyright law: that is to say, a work containing the Program or a portion of it, either verbatim or with modifications and/or translated into another language. (Hereinafter, translation is included without limitation in the term "modification".) Each licensee is addressed as "you".

Activities other than copying, distribution and modification are not covered by this License; they are outside its scope. The act of running the Program is not restricted, and the output from the Program is covered only if its contents constitute a work based on the Program (independent of having been made by running the Program). Whether that is true depends on what the Program does.

1. You may copy and distribute verbatim copies of the Program's source code as you receive it, in any

medium, provided that you conspicuously and appropriately publish on each copy an appropriate copyright notice and disclaimer of warranty; keep intact all the notices that refer to this License and to the absence of any warranty; and give any other recipients of the Program a copy of this License along with the Program. You may charge a fee for the physical act of transferring a copy, and you may at your option offer warranty protection in exchange for a fee.

2. You may modify your copy or copies of the Program or any portion of it, thus forming a work based on the Program, and copy and distribute such modifications or work under the terms of Section 1 above, provided that you also meet all of these conditions:

- a) You must cause the modified files to carry prominent notices stating that you changed the files and the date of any change.
 - b) You must cause any work that you distribute or publish, that in whole or in part contains or is derived from the Program or any part thereof, to be licensed as a whole at no charge to all third parties under the terms of this License.
 - c) If the modified program normally reads commands interactively when run, you must cause it, when started running for such interactive use in the most ordinary way, to print or display an announcement including an appropriate copyright notice and a notice that there is no warranty (or else, saying that you provide a warranty) and that users may redistribute the program under these conditions, and telling the user how to view a copy of this License. (Exception: if the Program itself is interactive but does not normally print such an announcement, your work based on the Program is not required to print an announcement.)
- These requirements apply to the modified work as a whole. If identifiable sections of that work are not derived from the Program, and can be reasonably considered independent and separate works in themselves, then this License, and its terms, do not apply to those sections when you distribute them as separate works. But when you distribute the same sections as part of a whole which is a work based on the Program, the distribution of the whole must be on the terms of this License, whose permissions for other licensees extend to the entire whole, and thus to each and every part regardless of who wrote it. Thus, it is not the intent of this section to claim rights or contest your rights to work written entirely by you; rather, the intent is to exercise the right to control the distribution of derivative or collective works based on the Program.

In addition, mere aggregation of another work not based on the Program with the Program (or with a work based on the Program) on a volume of a storage or distribution medium does not bring the other work under the scope of this License.

3. You may copy and distribute the Program (or a work based on it, under Section 2) in object code or executable form under the terms of Sections 1 and 2 above provided that you also do one of the following:

- a) Accompany it with the complete corresponding machine-readable source code, which must be distributed under the terms of Sections 1 and 2 above on a medium customarily used for software interchange; or,
- b) Accompany it with a written offer, valid for at least three years, to give any third party, for a charge no more than your cost of physically performing source distribution, a complete machine-readable copy of the corresponding source code, to be distributed under the terms of Sections 1 and 2 above on a medium customarily used for software interchange; or,
- c) Accompany it with the information you received as to the offer to distribute corresponding source code. (This alternative is allowed only for noncommercial distribution and only if you received the program in object code or executable form with such an offer, in accord with Subsection b above.)

The source code for a work means the preferred form of the work for making modifications to it. For an executable work, complete source code means all the source code for all modules it contains, plus any associated interface definition files, plus the scripts used to control compilation and installation of the executable. However, as a special exception, the source code distributed need not include anything that is normally distributed (in either source or binary form) with the major components (compiler, kernel, and so on) of the operating system on which the executable runs, unless that component itself accompanies the executable.

If distribution of executable or object code is made by offering access to copy from a designated place, then offering equivalent access to copy the source code from the same place counts as distribution of the source code, even though third parties are not compelled to copy the source along with the object code.

4. You may not copy, modify, sublicense, or distribute the Program except as expressly provided under this License. Any attempt otherwise to copy, modify, sublicense or distribute the Program is void, and will automatically terminate your rights under this License. However, parties who have received copies, or rights, from you under this License will not have their licenses terminated so long as such parties remain in full compliance.

5. You are not required to accept this License, since you have not signed it. However, nothing else grants you permission to modify or distribute the Program or its derivative works. These actions are prohibited by

law if you do not accept this License. Therefore, by modifying or distributing the Program (or any work based on the Program), you indicate your acceptance of this License to do so, and all its terms and conditions for copying, distributing or modifying the Program or works based on it.

6. Each time you redistribute the Program (or any work based on the Program), the recipient automatically receives a license from the original licensor to copy, distribute or modify the Program subject to these terms and conditions. You may not impose any further restrictions on the recipients' exercise of the rights granted herein. You are not responsible for enforcing compliance by third parties to this License.

7. If, as a consequence of a court judgment or allegation of patent infringement or for any other reason (not limited to patent issues), conditions are imposed on you (whether by court order, agreement or otherwise) that contradict the conditions of this License, they do not excuse you from the conditions of this License. If you cannot distribute so as to satisfy simultaneously your obligations under this License and any other pertinent obligations, then as a consequence you may not distribute the Program at all. For example, if a patent license would not permit royalty-free redistribution of the Program by all those who receive copies directly or indirectly through you, then the only way you could satisfy both it and this License would be to refrain entirely from distribution of the Program.

If any portion of this section is held invalid or unenforceable under any particular circumstance, the balance of the section is intended to apply and the section as a whole is intended to apply in other circumstances. It is not the purpose of this section to induce you to infringe any patents or other property right claims or to contest validity of any such claims; this section has the sole purpose of protecting the integrity of the free software distribution system, which is implemented by public license practices. Many people have made generous contributions to the wide range of software distributed through that system in reliance on consistent application of that system; it is up to the author/donor to decide if he or she is willing to distribute software through any other system and a licensee cannot impose that choice. This section is intended to make thoroughly clear what is believed to be a consequence of the rest of this License.

8. If the distribution and/or use of the Program is restricted in certain countries either by patents or by copyrighted interfaces, the original copyright holder who places the Program under this License may add an explicit geographical distribution limitation excluding those countries, so that distribution is permitted only in or among countries not thus excluded. In such case, this License incorporates the limitation as if written in the body of this License.

9. The Free Software Foundation may publish revised and/or new versions of the General Public License from time to time. Such new versions will be similar in spirit to the present version, but may differ in detail to address new problems or concerns.

Each version is given a distinguishing version number. If the Program specifies a version number of this License which applies to it and "any later version", you have the option of following the terms and conditions either of that version or of any later version published by the Free Software Foundation. If the Program does not specify a version number of this License, you may choose any version ever published by the Free Software Foundation.

10. If you wish to incorporate parts of the Program into other free programs whose distribution conditions are different, write to the author to ask for permission. For software which is copyrighted by the Free Software Foundation, write to the Free Software Foundation; we sometimes make exceptions for this. Our decision will be guided by the two goals of preserving the free status of all derivatives of our free software and of promoting the sharing and reuse of software generally.

NO WARRANTY

11. BECAUSE THE PROGRAM IS LICENSED FREE OF CHARGE, THERE IS NO WARRANTY FOR THE PROGRAM, TO THE EXTENT PERMITTED BY APPLICABLE LAW. EXCEPT WHEN OTHERWISE STATED IN WRITING THE COPYRIGHT HOLDERS AND/OR OTHER PARTIES PROVIDE THE PROGRAM "AS IS" WITHOUT WARRANTY OF ANY KIND, EITHER EXPRESSED OR IMPLIED, INCLUDING, BUT NOT LIMITED TO, THE IMPLIED WARRANTIES OF MERCHANTABILITY AND FITNESS FOR A PARTICULAR PURPOSE. THE ENTIRE RISK AS TO THE QUALITY AND PERFORMANCE OF THE PROGRAM IS WITH YOU. SHOULD THE PROGRAM PROVE DEFECTIVE, YOU ASSUME THE COST OF ALL NECESSARY SERVICING, REPAIR OR CORRECTION.

12. IN NO EVENT UNLESS REQUIRED BY APPLICABLE LAW OR AGREED TO IN WRITING WILL ANY COPYRIGHT HOLDER, OR ANY OTHER PARTY WHO MAY MODIFY AND/OR REDISTRIBUTE THE PROGRAM AS PERMITTED ABOVE, BE LIABLE TO YOU FOR DAMAGES, INCLUDING ANY GENERAL, SPECIAL, INCIDENTAL OR CONSEQUENTIAL DAMAGES ARISING OUT OF THE USE OR INABILITY TO USE THE PROGRAM (INCLUDING BUT NOT LIMITED TO LOSS OF DATA OR DATA BEING RENDERED INACCURATE OR LOSSES SUSTAINED BY YOU OR THIRD PARTIES OR A FAILURE OF THE PROGRAM TO OPERATE WITH ANY OTHER PROGRAMS), EVEN IF SUCH HOLDER OR OTHER

PARTY HAS BEEN ADVISED OF THE POSSIBILITY OF SUCH DAMAGES.

END OF TERMS AND CONDITIONS

How to Apply These Terms to Your New Programs

If you develop a new program, and you want it to be of the greatest possible use to the public, the best way to achieve this is to make it free software which everyone can redistribute and change under these terms. To do so, attach the following notices to the program. It is safest to attach them to the start of each source file to most effectively convey the exclusion of warranty; and each file should have at least the "copyright" line and a pointer to where the full notice is found.

one line to give the program's name and an idea of what it does.

Copyright (C) yyyy name of author

This program is free software; you can redistribute it and/or modify it under the terms of the GNU General Public License as published by the Free Software Foundation; either version 2 of the License, or (at your option) any later version.

This program is distributed in the hope that it will be useful, but WITHOUT ANY WARRANTY; without even the implied warranty of MERCHANTABILITY or FITNESS FOR A PARTICULAR PURPOSE. See the GNU General Public License for more details.

You should have received a copy of the GNU General Public License along with this program; if not, write to the Free Software Foundation, Inc., 51 Franklin Street, Fifth Floor, Boston, MA 02110-1301, USA.

Also add information on how to contact you by electronic and paper mail.

If the program is interactive, make it output a short notice like this when it starts in an interactive mode:

Gnomovision version 69, Copyright (C) year name of author

Gnomovision comes with ABSOLUTELY NO WARRANTY; for details

type `show w'. This is free software, and you are welcome

to redistribute it under certain conditions; type `show c' for details.

The hypothetical commands `show w' and `show c' should show the appropriate parts of the General Public License. Of course, the commands you use may be called something other than `show w' and `show c'; they could even be mouse-clicks or menu items--whatever suits your program.

You should also get your employer (if you work as a programmer) or your school, if any, to sign a "copyright disclaimer" for the program, if necessary. Here is a sample; alter the names:

Yoyodyne, Inc., hereby disclaims all copyright interest in the program `Gnomovision' (which makes passes at compilers) written by James Hacker.

signature of Ty Coon, 1 April 1989

Ty Coon, President of Vice

Déclaration de conformité CE

Nous, Intenso GmbH,
avec siège à Diepholzer Str. 15 à 49377 Vechta, Allemagne

déclarons sous notre responsabilité que le produit :

Modèle : 7" Intenso TAB 734 (n° article 5509854)
Description : ordinateur tablette

est conforme aux directives et normes suivantes :

directive R&TTE 1999/5/CE

- EN 301 489-1 V1.9.2
- EN 301 489-17 V2.1.1
- EN 300 328 V1.7.1 : 2006-10
- EN 55022:2010 (Class B)
- EN 55024:2010
- EN 61000-3-2:2006+A1 :2009+A2 :2009 (Class D)
- EN 61000-3-3:2008

directive basse tension 2006/95/CE

- EN 60950-1:2006+A11:2009+A1:2010+A12:2011+A12:correction 2012

directive conception écologique 2009/125/CE

- 1275/2008
- 278/2009

directive ROHS 2011/65/EU

Les documents techniques faisant référence à l'appareil cité en haut sont déposés à l'endroit suivant :

Intenso GmbH
Diepholzer Str. 15, 49377 Vechta, Allemagne

Personne autorisée :

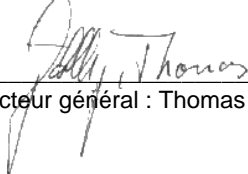

Directeur général : Thomas Pöhlking

Manual de instrucciones TAB 734

Muchas gracias por haberse decidido por el **TAB734**. Por favor siga las instrucciones de este manual para estar informado sobre las funciones más importantes de este dispositivo.



1.) Índice

1.) Índice	1
2.) Avisos	2
3.) Vista general del aparato	4
4.) Contenido del paquete	4
5.) Carga de la batería	5
6.) Empleo de la tarjeta Micro SD/SDHC/SDXC	5
7.) Transferencia de datos entre el aparato y un ordenador	5
8.) Pantalla táctil	6
9.) WIFI	6
Conexión automática	6
Conexión manual	7
10.) Pantalla inicial	8
Visualización	8
Desbloqueo de la pantalla	8
Barra de estado	9
Adaptación de la pantalla de inicio	10
Empleo de diversas pantallas iniciales	10
Aplicaciones preinstaladas en la pantalla inicial	11
11.) Resumen de las aplicaciones	11
<i>Resumen de aplicaciones</i>	11
12.) Enviar / recibir e-mails	12
Instalar su cuenta de email	12
Administración de una cuenta de correo electrónico	13
Agregar un buzón de correo nuevo:	13
Borrar un buzón de correo:	13
Comprobación de las propiedades de las cuentas:	13
Ver mensajes de email	13
Escribir mensajes de correo electrónico	13
13.) Web Browser	14
Utilización del teclado virtual	14
Inserción de símbolos	14
Empleo del Web Browsers	15
14.) Configuraciones del sistema	15
Resumen de las configuraciones mas importantes	16
15.) Gestión de aplicaciones	17
Instalación de las aplicaciones	17
Desinstalación de aplicaciones	17
16.) Fichero Explorer	18
Navegar entre ficheros y carpetas	18
Utilizar la barra de herramientas	18
Copiar, mover y renombrar ficheros y carpetas	18
17.) Condiciones de garantía limitada	19
18.) Datos técnicos	20
19.) Mantenimiento del aparato	20
20.) Limpieza del aparato	20
21.) Eliminación de aparatos electrónicos fuera de uso	20
22.) La licencia información	21
Declaración de conformidad CE	25

Es posible que este manual no contenga todas las funciones de su aparato. Para hacer uso de aplicaciones que provienen de operadores terceros, le rogamos que contacte a su operador. Tenga en cuenta que cualquier especificación puede ser modificada sin previo aviso. Si desea conocer informaciones actuales, consulte la página www.intenso.de

Marca

Google™, Google™-Logo and Android™ son marcas de Google Inc.. Todos los demás nombres de productos o servicios son propiedad de sus dueños respectivos.

2.) Avisos

- Evite un impacto brusco del aparato. No coloque el aparato en superficies inclinadas para evitar su caída.
- No haga uso del aparato en lugares extremadamente fríos, calientes, húmedos o repletos de polvo. Evite también la exposición directa al sol del aparato.
- Evite su utilización en lugares arenosos.
- No emplee el aparato en las proximidades de lugares con riesgo de explosión, como puede ser el surtidor de una gasolinera.
- Evite su empleo en cojines, sofás u otros objetos que fomenten la creación de calor, pues existe el riesgo de sobrecalentamiento del aparato.
- Guarde sus datos de forma regular para evitar una posible pérdida de datos. No nos hacemos responsables en el caso de una eventual pérdida de datos.
- No separe la conexión mientras transfiere datos o cuando se va a formatear el aparato. Esta separación puede conllevar una pérdida de datos.
- Imágenes y videos pueden estar protegidos por los derechos de terceras personas. La reproducción sin licencia puede violar los derechos de autor.
- Evite el empleo del aparato en campos altamente magnetizados.
- Proteja a su aparato de la humedad. Si entra humedad en el aparato, apáguelo inmediatamente y dispóngase a limpiarlo y secarlo.
- No emplee soluciones químicas a la hora de limpiar el aparato. Utilice simplemente un paño seco para limpiarlo.
- No coloque llamas abiertas, como pueden ser velas encendidas, cerca o sobre el aparato.
- No nos hacemos responsables de daños producidos a causa de un funcionamiento incorrecto, pérdida de datos, manejo incorrecto, y propia reparación del aparato o cambio de batería.
- En el caso de que el aparato no reaccione a sus entradas, le rogamos que emplee el botón de reset que se encuentra en el reverso del aparato para que pueda reiniciarse.
- Cuando no lo vaya a utilizar, retire el transformador de la fuente de energía.
- El enchufe ha de encontrarse cerca del aparato y ser de fácil acceso
- Haga uso del transformador solo en tomas de tierra con AC 100-240V~, 50/60 Hz. En caso de no tener la certeza de que la fuente de energía local sea segura, consulte al distribuidor de energía respectivo.
- Emplee únicamente el transformador y el cable de conexión a la red ha recibido con este aparato.
- Para interrumpir el abastecimiento de energía de su aparato, retire la fuente de alimentación de la corriente. Sujete con cuidado el transformador en el momento de retirarlo del enchufe. No apriete nunca el cable.

- Nunca abra la caja del adaptador de red. En caso de apertura de la caja se corre peligro de vida debido al choque eléctrico. No contiene piezas que requieran mantenimiento.
- En caso de no utilizar el aparato durante un periodo prolongado, la batería comienza a descargarse lentamente. Antes de volver a utilizar el aparato, debe recargarla.
- Le rogamos que elimine el aparato o la batería de manera ecológica.
- Por favor no desmonte los componentes del aparato ni intente repararlo por sí mismo, pues en ese caso la garantía expira.
- No emplee el aparato en lugares en que la utilización de aparatos móviles se encuentre prohibida. No utilice el aparato cerca de otros aparatos eléctricos, ya que puede ocasionar interferencias debido a las señales de alta frecuencia.
- No utilice el aparato cerca de un marcapasos, en un hospital o próximo a aparatos médicos, pues puede causar interferencias debido a las señales de alta frecuencia. Mantenga una distancia mínima de 15 cm respecto a la posición de un marcapasos. Consulte al productor de ese aparato en concreto para obtener información sobre su empleo común.
- El uso de auriculares a un volumen demasiado alto puede causar daños irreparables en el oído. Tenga en cuenta que el constante volumen alto puede ocasionar una pérdida permanente del oído. Para evitar posibles riesgos de salud causados por un volumen demasiado alto le recomendamos la utilización del auricular incluido en la entrega.
- Por motivos de seguridad vial, este aparato no debe ser usado por el conductor durante cualquier trayecto.

3.) Vista general del aparato

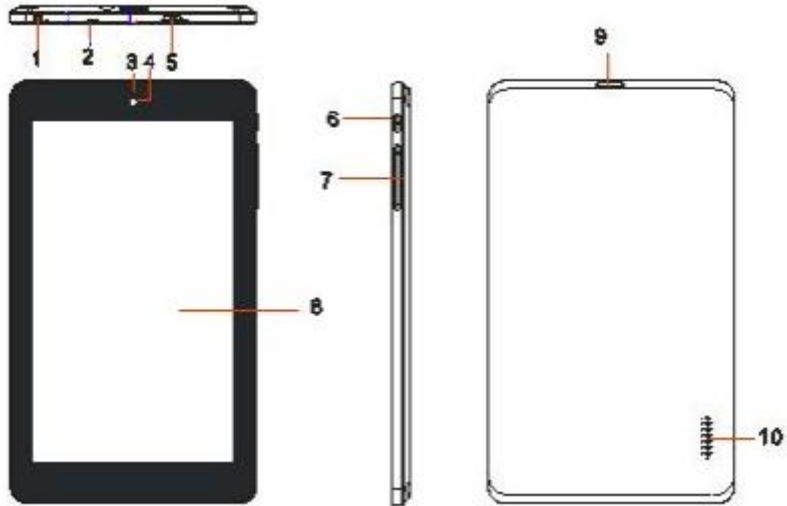

- (1) Conector de auricular de 3.5mm
- (2) Micrófono integrado
- (3) Indicador de carga: Rojo durante la carga - amarillo cuando está completamente cargado.
- (4) Cámara frontal
- (5) Casquillo micro USB

- (6) Botón on / off: mantenga el botón pulsado para apagar el aparato; apriete el botón brevemente para cambiar de Standby o "botón de guardia" a Modo Activo
- (7) Volumen + / -
- (8) Touchscreen
- (9) Ranura para la tarjeta micro SD
- (10) Altavoz integrado

4.) Contenido del paquete

Por favor verifique que el contenido del paquete está completo:

- TAB 734
- Auricular estéreo
- Cable de USB
- Transformador 5V 1.2A
- Manual de instrucciones

5.) Carga de la batería

Por favor, **cargue la batería por completo antes** del primer uso del dispositivo. **Conecte el adaptador de corriente** incluido con el dispositivo a una **toma de corriente**. La **carga completa dura unas 5 horas**. El **estado de carga** se muestra en el **lado delantero izquierdo** del dispositivo. La luz del **LED** se ilumina en **rojo durante la carga** y **cambia a amarillo** cuando la **batería está totalmente cargada**.

Indicaciones:

- a. Cuando a la batería le quede menos del 15% de carga, aparecerá en la pantalla un mensaje de advertencia. Entonces debe conectar el aparato a un enchufe empleando el transformador para proceder a la recarga de la batería, con el fin de evitar la pérdida de datos y aumentar la duración de la batería.
 - b. Puede utilizar el aparato mientras la batería se recarga. Sin embargo, para asegurar la larga duración de la batería, le rogamos que no haga uso del aparato mientras la batería está cargando.
 - c. Para asegurar el buen funcionamiento del aparato, la batería integrada debe ser utilizada de forma habitual. Si no emplea el aparato habitualmente, recargue la batería completamente al menos una vez al mes.
 - d. Asegúrese de que solo emplea el transformador incluido en el paquete para recargar la batería.
-

6.) Empleo de la tarjeta Micro SD/SDHC/SDXC

Este dispositivo puede leer datos **directamente** desde una tarjeta **Micro SD/SDHC/SDXC con una capacidad máxima de 64 GB**. Para poder usar una tarjeta **Micro SD/SDHC/SDXC** introdúzcala en la ranura Micro SD Slot prevista en la **parte izquierda del dispositivo**. Use el **explorador preinstalado** para poder acceder a **los datos** en la **tarjeta de memoria**. escoja en el **explorador** el índice **“SD Card”**.

7.) Transferencia de datos entre el aparato y un ordenador

- 1.) Conecte el **aparato** al **ordenador** con ayuda del **cable de USB** que se le proporciona.
- 2.) En el aparato se muestra ahora la **pantalla** con la **conexión USB**. Pulse **brevemente** la tecla de **activación de la memoria de USB**. El aparato se reconocerá **como soporte de datos móviles** y usted recibirá la información de la **memoria de USB en funcionamiento**. Tras pulsar **brevemente** la tecla **Home**, puede volver a utilizar el aparato de forma normal. **Desde su ordenador** tiene ahora acceso a la **memoria interna del aparato** y puede **copiar, eliminar o mover datos** del aparato.
- 3.) Si existe una **conexión USB** con el ordenador, le aparecerá un **símbolo de USB** en la barra de estado. En la barra de estado ampliada obtendrá **información adicional** y podrá **activar o desactivar** la conexión USB.
 - Para **desactivar** la memoria, elija **“desactivar memoria USB”**.
 - Elija en el ordenador la **función “Retirar de forma segura”**  para separar **el dispositivo del ordenador**.

Nota: las aplicaciones instaladas en el sistema operativo Android™ ocupan una parte de la memoria interna dada. Por este motivo no se encuentra la totalidad de la memoria interna a su disposición.

8.) Pantalla táctil



Este dispositivo se maneja mediante una **pantalla táctil**. Puede **iniciar aplicaciones, introducir textos con el teclado virtual, pulsando brevemente** en la **pantalla táctil** y cambiar entre las **diversas pantallas de inicio deslizándolas hacia la dirección deseada**.

Por favor **retire la película protectora de la pantalla** antes de **utilizar** el aparato.

La pantalla táctil identifica pequeñas **cargas eléctricas**, tales como las emitidas por los dedos de la mano, **definiéndose así como punto de entrada**. Por consiguiente, es preferible que utilice las **puntas de sus dedos** para efectuar las **entradas**. Su empleo por medio de un **bolígrafo o de otro objeto agudo** no es posible.

La **pantalla táctil no** ha de **entrar en contacto** con agua u otros equipamientos eléctricos para evitar un **mal funcionamiento del aparato o defectos permanentes**.

Advertencias:

- a. *Si la pantalla táctil no se usa durante dos minutos, el aparato pasa a encontrarse en modo Standby. Pulsen brevemente la tecla On/Off para cambiar al modo activo.*
 - b. *El bloqueo del teclado se encuentra activado automáticamente con el fin de evitar entradas no deseadas. Por favor desbloquee el teclado de la pantalla táctil. Toque el candado cerrado  en la pantalla y manténgalo presionado. A continuación presione sobre el candado para que aparezca un candado abierto  y quite el dedo de la pantalla. La pantalla está desbloqueada ahora.*
-

El aparato puede girar **en todas las direcciones**, pues dispone de un **sensor que ajusta la pantalla automáticamente**.

9.) WIFI

Para conectar el aparato con su Internet necesita una conexión WIFI. Para activarla, abra los ajustes en los ajustes WIFI.

Advertencia: *tenga en cuenta que necesita tener una red de WLAN al alcance desde su posición actual.*

Conexión automática

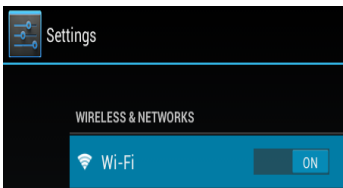

Sitúese en Ajustes y abra los ajustes WIFI. Aquí puede activar o desactivar de forma fácil la función WIFI. Simplemente desplace el interruptor virtual desde la posición "Encendido" hacia la izquierda para desactivar la función WIFI. La pantalla cambia ahora a "Apagado".

Para volver a activar la función WIFI desactivada, desplace el interruptor virtual hacia la derecha.

En la **configuración inalámbrica** aparecen en el lado derecho todas las **redes disponibles** y **todas las redes ya utilizadas**.

Por favor escoja la **red deseada** y escriba la **contraseña** (password) para esa **red WLAN**, de modo que se pueda **establecer una conexión**.

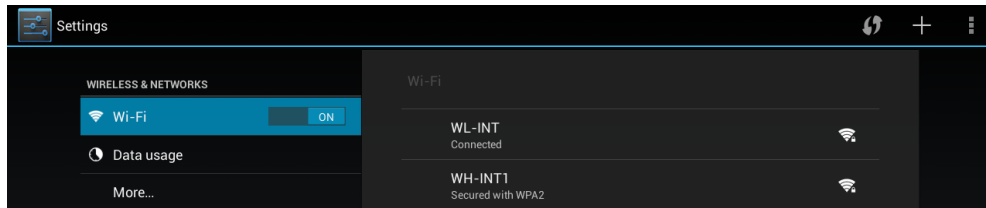

Dado el caso, **confirme** la contraseña introducida, tecleándolo, luego pulse **Enter** y, por último, haga clic en **Conectar**. Después de un **momento se establece la conexión**.

Notas:

- a) Si se cambia al aparato al modo Standby, la WLAN se desactivará automáticamente. Esto reduce el consumo de energía y conduce automáticamente al aumento de la duración de la batería. Cuando el aparato vuelve a pasar al modo activo, la conexión WLAN se restaura automáticamente. Esta operación puede durar unos segundos.
 - b) La lista de las redes WLAN que se encuentran actualmente disponibles se actualiza automáticamente.
 - c) Cuando la función WLAN se encuentra activada, el aparato se conecta automáticamente a una red anteriormente configurada, siempre que se encuentre al alcance.
 - d) Cuando una red WLAN desconocida se encuentra al alcance, aparece un panel informativo en la pantalla.
-

Conexión manual

Para **buscar** de forma manual una red WLAN **accesible**, proceda como sigue:



- (1) Abra los **Ajustes**.
- (2) Ahora abra los **Ajustes Wi-Fi** y pulse en “**Escanear**”.
- (3) En el caso de que la red Wi-Fi **no** aparezca en la **lista de redes disponibles**, seleccione el punto “**Añadir red**” para introducir manualmente la **red SSID**, el **protocolo de seguridad** y, en caso de ser necesario, la **contraseña** correspondiente. Para **confirmar** su **entrada de datos**, pulse “**Guardar**”.

10.) Pantalla inicial

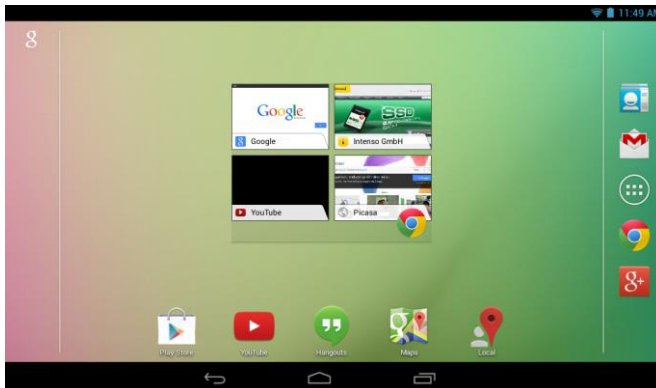
Visualización



Desbloqueo de la pantalla

Si **no** utiliza la pantalla táctil durante **más de dos minutos**, el dispositivo cambia a **modo Standby**. Presione **brevemente** el botón **On/Off** para **activarlo**. La **pantalla** está **protegida** para evitar **entradas no deseadas**. Toque el **candado cerrado**  en la pantalla y **manténgalo presionado**. A continuación **presione sobre** el **candado** para que aparezca un **candado abierto**  y quite el dedo de la **pantalla**. La **pantalla** está **desbloqueada** ahora

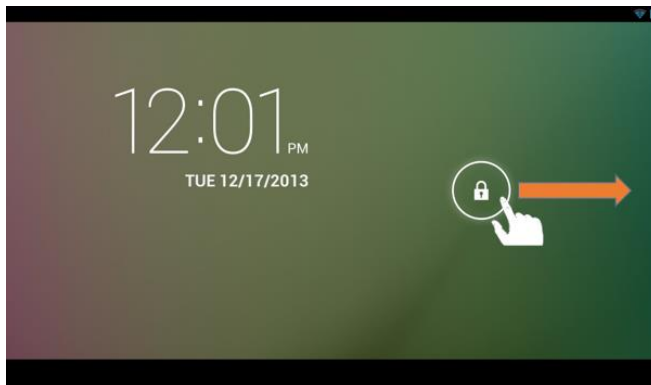

Mueva el símbolo de cerradura con sus dedos en la dirección que indica la flecha

Nota: *apriete el icono del candado para que aparezca el icono de la cámara para ir directamente a la aplicación.*

Barra de estado

Las **barras de estado** se encuentran en **la parte superior e inferior** de la **pantalla estándar**.

La **barra de estado superior** se divide en **dos partes**. Si arrastra la barra del **lado izquierdo** hacia abajo, se mostrarán **las notificaciones actuales**, en caso de que existan.

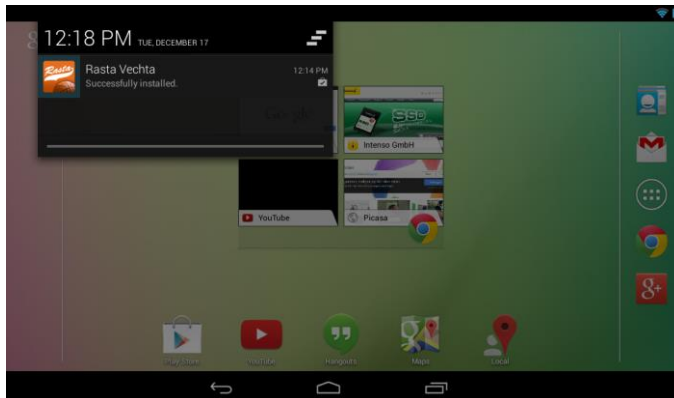

Si arrastra la barra del **lado derecho** hacia abajo, se muestran los **campos de acceso rápido** para **diversos ajustes**.

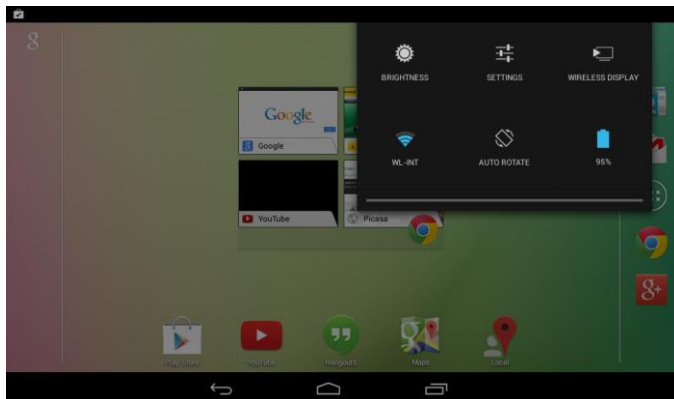

En la **barra de estado inferior** tiene la posibilidad de cambiar a **la pantalla anterior** o bien de **ocultar el teclado virtual**, acceder directamente a la **pantalla de inicio**, visualizar **los últimos programas utilizados** y **ajustar el volumen** del aparato.



Adaptación de la pantalla de inicio

Puede adaptar su **pantalla de inicio** de forma muy simple a sus **necesidades individuales**. Si desea **borrar un icono, mantenga pulsado con el dedo el icono y arrástrelo** hacia símbolo X que se muestra. Ahora **retire el dedo de la pantalla táctil y el icono será borrado**.

Si desea posicionar un **icono de la vista general de aplicaciones en la pantalla de inicio, mantenga pulsado el icono en la vista general de aplicaciones** y aparecerá la **pantalla de inicio**. **Arrastre el icono** hacia el **lugar deseado** y **retire el dedo de la pantalla táctil**. El **icono** le ha sido **añadido** de esta forma a la pantalla de inicio. Si posiciona un icono encima del otro, automáticamente se crea una carpeta con ambos iconos. Pulse en la carpeta para ver todos los iconos guardados en ella y elija el icono deseado pulsando brevemente sobre él.

Puede añadir además Widgets a la pantalla de inicio. Para ello, abra el resumen de aplicaciones. Pulse primero en la palabra Widgets. Ahora se muestran todos los Widgets disponibles en su aparato. El añadido de un Widget a la pantalla de inicio funciona exactamente como el añadido de un Icono.

Si desea cambiar el fondo de pantalla, pulse en un lugar libre en una pantalla de inicio y mantenga el dedo en la pantalla hasta que aparezca el menú de selección de fondos de pantalla.

Empleo de diversas pantallas iniciales

Tiene a su disposición **cinco pantallas de inicio configurables individualmente**. **Arrastrando ligeramente** hacia la **izquierda o la derecha**, se puede **cambiar** fácilmente entre las unas y las otras.

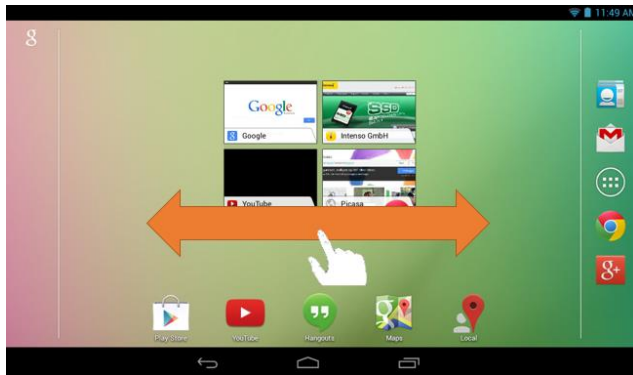

Pulsando la tecla "Home" se vuelve siempre automáticamente hasta la pantalla de inicio central.

Aplicaciones preinstaladas en la pantalla inicial



A Enlace a la búsqueda con Google™

B Descripción general de marcadores para el navegador Chrome™

C Contactos, Gmail™, Anwendungsübersicht, Chrome™ y Google+™

D Google Play Store™ , YouTube™ , Hangouts™ , Maps™ y Local™

11.) Resumen de las aplicaciones



Pulse **con brevedad** el **icono del resumen de aplicaciones**, con el fin de **abrir el resumen de aplicaciones** dado. Ahora visualiza **un resumen** de todas las **aplicaciones preinstaladas e instaladas** por su cuenta. Abra la **aplicación deseada** con un **breve clic** en el **icono** correspondiente.

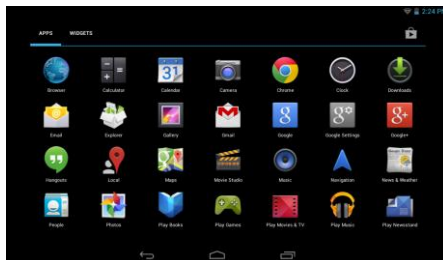

Resumen de aplicaciones

12.) Enviar / recibir e-mails

Este aparato cuenta con una **aplicación de email** preinstalada. Se le permite utilizar su cuenta de **email** para **enviar y recibir** emails.

Advertencia: esta función requiere una **conexión a Internet WLAN**.

Abra esta aplicación a través del **icono “E-Mail”**, que se encuentra en el **menú de aplicaciones**.

Instalar su cuenta de email

- (1) **Inicie** la aplicación de email **pinchando** en el símbolo de **e-mail**. Ahora se le invita a **instalar su cuenta de e-mail**.
- (2) Inserte su **dirección de e-mail** así como su **respectiva contraseña** y pulse **“siguiente”**. **Ponga un nombre a su cuenta y establezca** su nombre para los **mensajes enviados**. Pulse la tecla **“terminar”** para **concluir la configuración**. Su **cuenta de e-mail** pasará a ser la **cuenta general** en caso de que tenga la opción de **“enviar emails por defecto desde esa cuenta”**.
- (3) También puede instalar **su cuenta de email manualmente**. Introduzca su **dirección de e-mail** y la **contraseña correspondiente**, y pulse el **“setup manual”** para insertar las **informaciones del servidor de e-mail**.
- (4) **Seleccione** entre tipos de servidores (**Servertypen POP3, IMAP o Exchange**) para la **recepción de emails**.

Advertencia: si desconoce qué configuraciones ha de efectuar, consulte por favor a su **proveedores por e-mail, su administrador de red, o busque las informaciones requeridas en Internet** partiendo de los términos **“Dirección POP”** y **“nombre de su proveedor”**.



- (5) Introduzca la siguiente **información** (Servicio, Puerto etc.).
- (6) Elija el **tipo de servidor** para los **e-mails** a enviar e inserte las **informaciones necesarias**.
- (7) Pulse **“continuar”** para **continuar con el menú**. La aplicación de e-mail **verifica** ahora las **configuraciones del servicio efectuadas**. Una vez **concluida la instalación de manera satisfactoria** aparece el siguiente aviso: **“tu cuenta está instalada y los emails están de camino”**. Su cuenta está ahora **configurada**.
- (8) Proporcione un nombre a su **cuenta** y pulse **terminar** para concluir el **proceso**.

Nota: si posee más de una dirección de correo electrónico, tendrá acceso a la **cuenta general siempre que se inicie la aplicación de e-mail**.

Administración de una cuenta de correo electrónico

Agregar un buzón de correo nuevo:

- (1) Abra la **aplicación de correo electrónico** y pulse en la **tecla Menu**  para mostrar las **opciones adicionales**. Seleccione el punto de menú **“Ajustes”** y después **“Añadir cuenta”**, para crear un nuevo buzón de correo.
- (2) Siga el **asistente de configuración** para **crear un nuevo buzón de correo**.

Borrar un buzón de correo:

- (1) Abra la **aplicación de correo electrónico** y pulse en la **tecla Menu**  para mostrar las **opciones adicionales**. Seleccione el punto de menú **“Ajustes”** y después **“Eliminar cuenta”**, para borrar la cuenta deseada

Comprobación de las propiedades de las cuentas:

- (1) Abra la **aplicación de correo electrónico** y pulse en la **tecla Menu**  para mostrar las **opciones adicionales** y seleccione **“Ajustes”**. En el **lado izquierdo** del menú aparecerán **todos los buzones de correo** creados.
- (2) Pulse **en el buzón de correo deseado** para mostrar los ajustes de la cuenta.
- (3) Pulse en las **“propiedades de cuenta”** a ser cambiadas para **efectuar los cambios** deseados

Ver mensajes de email

Abra la **aplicación de e-mail** haciendo un **breve click** sobre el **icono del e-mail**. Su **buzón** se puede ahora **visualizar**.

- A través de **movimientos verticales** puede desplazar sus **e-mails**.
- Haga click en un **e-mail determinado** con el fin de **abrirlo**.
- Mantenga el **dedo pulsado** en un **e-mail determinado**, para poder visualizar **otras opciones**. Ahora aparece un **panel de información**. Usted puede aquí **abrir el e-mail, contestarlo, reenviarlo o eliminarlo**.

Escribir mensajes de correo electrónico

- (1) Pulse en la vista general del correo electrónico en el **símbolo Email** en la **barra de menú superior** y se abrirá **una ventana nueva**, en el cual puede **escribir un nuevo correo electrónico**.
- (2) Ahora introduzca la **dirección de correo electrónico** del destinatario, un **asunto** y el **texto** en los campos previstos para ello. También puede añadir **„CC/CCO“** para enviar un correo electrónico a varios destinatarios.
- (3) Pulse en **“Enviar”**, para enviar el correo electrónico. Pulse en **“Guardar”** para guardar **el correo electrónico introducido como borrador**. Si pulsa en el **“Símbolo de la papelerá”**, se borrará el correo electrónico introducido actualmente.

13.) Web Browser

Para iniciar el **Web Browser**, pinche en el **icono Browser**  que se encuentra en la pantalla inicial. Para abrir una **página de Internet**, pulse en la **parte superior de las entradas** para visualizar la **dirección de Internet**. El teclado virtual se abre ahora y usted puede elegir la **dirección de la página de Internet** deseada. Pinche en **“comenzar”** o en el **símbolo** al lado del **campo de entradas** para abrir la página web.

Advertencia: no todas las redes ofrecen acceso a la red. Algunas redes ofrecen solo acceso a otros ordenadores locales conectados y no conexión a Internet.

Utilización del teclado virtual

Pinche en el **campo de entradas** para abrir el **teclado virtual**. Puede **componer un texto** o **acceder a páginas de Internet**.





- Caps Lock (letras mayúsculas o minúsculas)
- Tecla para “volver”
- Acceso al menú de números, símbolos y caracteres especiales
- Space Taste (espacio o entrada en blanco)
- Comenzar (confirmación de su entrada)

Inserción de símbolos

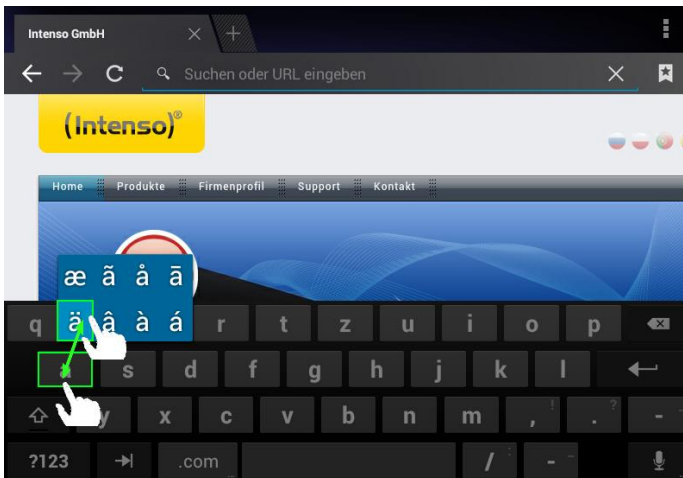
Para insertar un **carácter especial** como por ejemplo “ä”, **mantenga pulsado con su dedo** la tecla “a” para acceder al **menú de caracteres especiales**. Deslice su dedo ahora al carácter especial deseado, por ejemplo la “ä” y despegue el dedo de la pantalla. De esta forma habrá introducido una “ä”.





Empleo del Web Browsers

- Puede desplazarse por la **pantalla** efectuando un movimiento de **desplazamiento vertical con sus dedos**. Por favor no comience el movimiento en un **punto del menú o link**, pues en ese caso podrían abrirse **otras aplicaciones existentes**.
- Para abrir un **link de Internet**, pinche suavemente sobre el **link**. La nueva **página** se abrirá de forma **automática**.
- Para abrir el **Menu del navegador web** pulse la **tecla de menú** . Aquí tiene a su disposición distintas funciones. Entre otras, puede **actualizar la página web abierta**, **abrir una pestaña nueva**, **configurar una página para que se pueda leer sin conexión** o bien **cambiar a los ajustes del navegador web**.
- Para **volver** a una página **ya visitada**, pulse la tecla **“volver”** .
- Para regresar **directamente** a la **pantalla de inicio**, pulse la tecla **“Home”** .
- Para insertar un **texto**, pinche en el **campo correspondiente** y emplee el **teclado virtual para insertar el texto**.

*Advertencia: esta función requiere una **conexión a Internet WLAN**.*

14.) Configuraciones del sistema

Pulse en el **menú de aplicaciones** en el icono de **Ajustes** para acceder a los **ajustes de sistema**.

- En la **parte izquierda del menú** podrá encontrar distintas **categorías**. **Pulsando brevemente** en la **entrada del menú** elegido anteriormente se muestran las **posibilidades de ajuste disponibles**. Por favor tenga en cuenta que no todas las funciones ofrecidas por Android™ son compatibles con este dispositivo.
- Una vez haya efectuado **todos los ajustes** podrá volver al menú anterior con la **tecla Volver**  o bien cambiar directamente a la **pantalla de inicio** con la **tecla Inicio** . Los **datos introducidos se guardan automáticamente**.

Resumen de las configuraciones mas importantes

Redes y redes inalámbricas	Wi-Fi	Efectúe aquí sus ajustes para Wi-Fi.
	Más	Aquí puede efectuar más ajustes de red.
Dispositivo	Sonidos	Ajuste aquí el volumen deseado y el sonido deseado para las notificaciones.. Además puede activar o desactivar un tono de confirmación al tocar la pantalla táctil y un tono de advertencia al desbloquear el bloqueo de pantalla.
	Pantalla	Brillo – Ajustar brillo de la pantalla. Fondo – Selección del fondo deseado. Estado de reposo – Ajuste el retardo en apagar la pantalla automáticamente. Tamaño de letra – Ajuste del tamaño de letra deseado.
	Memoria	Aquí obtendrá información sobre la memoria interna y, en el caso de ser utilizada, de su tarjeta MicroSD. Además puede eliminar el contenido de la memoria.
	Batería	Aquí obtendrá información sobre el estado de carga de la batería integrada.
	Aplicaciones	Aquí podrá administrar las aplicaciones instaladas y obtener información sobre las aplicaciones.
Usuario	Servicios de ubicación	Aquí podrá permitir a las distintas aplicaciones Android™ reconocer su ubicación mediante redes inalámbricas y utilizar esta información (p.ej. Google Maps™). Además podrá establecer si desea que Google™ pueda adaptar los resultados de búsqueda a su ubicación.
	Seguridad	Aquí podrá, por ejemplo, establecer un bloqueo de pantalla y efectuar otros ajustes relevantes en cuanto a seguridad.
	Idioma e introducción	Aquí podrá ajustar, por ejemplo, su idioma preferido, añadir palabras diversas al diccionario personalizado y efectuar ajustes en el teclado..
	Guardar y restablecer	Aquí podrá guardar sus ajustes de sistema y sus datos de aplicación en servidores de Google™. Además, también puede restablecer los ajustes de fábrica. ATENCIÓN: En ese caso se borrarán todos los datos guardados en el dispositivo.
Cuentas	Añadir cuentas	Aquí puede añadir diferentes cuentas.
Sistema	Hora y fecha	Aquí podrá ajustar la fecha, la hora, la zona horaria el formato de visualización.
	Sobre la tableta	Le muestra información sobre el dispositivo.

15.) Gestión de aplicaciones

Aplicaciones pre-instaladas

Este aparato se entrega con **aplicaciones preinstaladas**. La **idea** de estas aplicaciones se encuentra en el **resumen de aplicaciones** . Para proceder a la **apertura de estas aplicaciones** ha de pulsar **brevemente el botón correspondiente**.

Instalación de las aplicaciones

Para **instalar aplicaciones** en el aparato, rogamos que siga los **pasos siguientes**:

- (1) Abra la **fuente deseada** para la **descarga de aplicaciones**, por ejemplo el preinstalado **Google Playstore™**. Para ello debe iniciar sesión primero con su **cuenta existente de Playstore™** o crear una **cuenta nueva de Playstore™**. Para ello, siga simplemente las **instrucciones** en la **pantalla**.
- (2) Después de **iniciar sesión con éxito** tiene a su disposición la amplia **elección de aplicaciones** del **Google Playstore™**. Seleccione la **aplicación deseada**, pulse en **instalar** y **confirme** en caso necesario la **autorización de acceso** de la aplicación. La **descarga** comienza ahora y el **progreso** se muestra en la **barra de estado** ampliada de arriba a la izquierda.
- (3) Después de la **descarga** de la aplicación, ésta se instala automáticamente. Podrá encontrar la **aplicación** nueva en el **menú de aplicaciones** una vez instalada con éxito. Puede ver el **progreso de la instalación** en la **barra de estado ampliada** de arriba a la izquierda.

Desinstalación de aplicaciones





- (1) Por favor abra los **ajustes de sistema** pulsando brevemente el icono **Ajustes** en la vista general de las aplicaciones.
- (2) Pulse ahora brevemente en el punto de menú "**Aplicaciones**", para llegar a los **Ajustes de Aplicación**.
- (3) Seleccione entre los puntos primarios "**bajados, memoria USB, activo y todos**" la vista general deseada, **pulsando brevemente**.
- (4) Ahora elige la **aplicación** que desea **desinstalar**, **pulsando brevemente**.
- (5) Ahora pulse en "**Desinstalar**" y **confirme** con **OK**, para desinstalar la **aplicación** del **dispositivo**.

Advertencia: no se puede eliminar Software que ya haya sido preinstalado

16.) Fichero Explorer

Abra el **resumen de aplicaciones** y seleccione rápidamente el **icono Explorer** para iniciar los ficheros Explorer.

Navegar entre ficheros y carpetas

- Tiene a su disposición una **memoria interna**, una **tarjeta de memoria** (tarjeta SD) y un **USB**. Seleccione su lugar de almacenamiento preferido para visualizar una **lista de los ficheros contenidos**. Si no se ha insertado ninguna **tarjeta de memoria** o ningún **dispositivo de memoria** conectado a la **conexión de USB**, se recibirá la información “desmontada”.
- A través de un **movimiento vertical** puede **desplazar** ficheros y carpetas. Abra un **fichero** o una **carpeta** pulsando dos veces brevemente.
- Puede seleccionar un **icono de “paso adelante”**  y “**paso hacia atrás**” .
- Para subir el nivel de la **estructura de los ficheros**, pulse brevemente el **icono LevelUp**. .
- Con el **icono de Home**  se puede ir **directamente** al **directorio principal**.

Utilizar la barra de herramientas





Pulse en la **tecla Menu**  y luego en “Ocultar barra de herramientas”, para mostrar u ocultar la **barra de herramientas**.

Home	Ir directamente al directorio principal.
LevelUp	Subir un nivel.
Multi	Seleccionar varios ficheros.
Editor	Copiar, apagar, mover, insertar o cambiar el nombre de un fichero o carpeta.
Carpeta nueva	Crea una carpeta nueva.
Back	Dar un paso atrás.
Next	Dar un paso hacia delante.

Copiar, mover y renombrar ficheros y carpetas

- 1.) **Navegue** por el **fichero deseado** dentro de la **lista de los ficheros**.
- 2.) Haga clic y mantenga el dedo **en el fichero** hasta que el **panel de información** aparezca.
- 3.) Ahora escoja la **función** que desee. Puede elegir entre **copiar, eliminar, mover y pegar** -se requiere la existencia de un fichero de **memoria temporal**- y renombrar.
- 4.) Para **copiar** o **mover** presione el icono correspondiente (copy/move) y **navegue** hasta el **directorio de destino**. **A continuación** marque el **icono de editor**  y escoja mediante un clic **breve** la opción “**paste**” para insertar el **fichero**.
- 5.) Para **apagar** el **fichero** pulse brevemente la opción “**delete**” y confírmelo **de nuevo** por razones de seguridad con la misma opción “**delete**”. Para **cancelar** pulse **brevemente** la opción “**cancelar**”.

- 6.) Para **renombrar** un **fichero** haga clic en la opción “**rename**” y, a continuación, escriba el nuevo **nombre del fichero** en el **teclado virtual**. **Confirme** con “**OK**” o interrumpa presionando la opción “**cancel**”.
- 7.) Puede copiar, eliminar o mover **varios ficheros y carpetas simultáneamente**. Para ello pulse el **Multi icono**  y, a continuación, seleccione los **ficheros que desee**. Los **ficheros seleccionados** aparecerán en **otro color**. Pulse el botón de **editar icono**  para efectuar la **acción** deseada.

17.) Condiciones de garantía limitada

La garantía cubre solamente la sustitución de este producto de Intenso. La garantía no es válida en el caso de desgastes resultantes de un uso inadecuado, negligencia, accidentes, incompatibilidad, o rendimiento insuficiente por parte de un cierto Hardware o Software de ordenador.

El derecho a la garantía expira en caso de incumplimiento de las instrucciones elaboradas por Intenso así como en caso de montaje o uso indebido o defectos causados por otros aparatos.

En caso de que el producto esté expuesto a vibraciones, descargas electroestáticas, influencia del calor o de la humedad, o en cualquier otro caso en que se exponga al producto más allá de sus especificaciones, no existe derecho a garantía.

Intenso no se responsabiliza por la pérdida de datos o por daños colaterales o subsecuentes, por la violación de las condiciones de garantía y por otros daños, independientemente de cuáles sean sus causas.

Este producto no se debe destinar a un uso comercial o a niveles medicinales o especiales, en los que una avería del producto pueda causar lesiones, fallecimiento o elevados daños materiales.

18.) Datos técnicos

CPU	1.0 GHz Dualcore based on Cortex A9
Memoria	1 GB DDR 3
Sistema operativo	Android 4.2.2
Sistemas operativos compatibles	Windows XP / Vista / 7 / 8 / Linux 2,4 y superior / Mac 10.6 y superior
Posibilidades de conectar	Auriculares, Micro SD (SDHC/SDXC), micro USB
WLAN	WiFi (802.11 b/g/n)
G-Sensor	Rotación de 360 grados
Formato de fotografía	JPEG, BMP, GIF, PNG
Formato de audio	MP3, WMA, WAV, OGG, FLAC, APE
Formato de vídeo	MPEG1, MPEG 4, FLV
Pantalla	TFT LCD pantalla, 1024 x 600 Pixels
Cámara	0,3 MP cámara frontal
SNR	>= 80 dB
Área de frecuencia	20 Hz – 20 KHz
Transformador	(V) AC Adapter (HUONIU HNBC050120UE): AC Input 100-240V~50/60Hz, DC Output 5V / 1.2A
Batería integrada	Batería recargable de iones de litio y polímero

19.) Mantenimiento del aparato

Nunca rocíe o acerque un aerosol o un líquido directamente a la pantalla o cubierta del aparato

20.) Limpieza del aparato

Limpie la caja, el armazón y la pantalla con un paño reblandecido, libre de pelusa y de químicos. Utilice únicamente detergentes que son exclusivos para limpiar pantallas.

21.) Eliminación de aparatos electrónicos fuera de uso

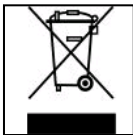

Los aparatos identificados con este símbolo están sujetos a la Directiva Europea 2002/96/EC.

Todos los equipamientos eléctricos y electrónicos han de separarse de la basura doméstica y deben ser eliminados por las respectivas instituciones públicas.

La eliminación debida de equipamientos electrónicos evita la contaminación del medio ambiente.

(Intenso)®

49377 Vechta
Germany
www.intenso.de



22.) La licencia información

Notice of GNU GENERAL PUBLIC LICENSE and LESSER GENERAL PUBLIC LICENCE

Dear Customer,

If interested, you and any third party can download the source code of used GPL / LGPL from Intenso Webpage <http://www.intenso.de>. The source code of the desired product is available to anyone on the selection of valid product category and the desired device. In the product details you will find the entry "drivers". Open this menu to download the corresponding GPL / LGPL code. For a fee of 35 € (delivery to another country as Germany), it is also possible to obtain this code by postal delivery. More information about the GPL/LGPL-Licence can you find on following website www.gnu.org

GNU GENERAL PUBLIC LICENSE

Version 2, June 1991

Copyright (C) 1989, 1991 Free Software Foundation, Inc.

51 Franklin Street, Fifth Floor, Boston, MA 02110-1301, USA

Everyone is permitted to copy and distribute verbatim copies of this license document, but changing it is not allowed.

Preamble

The licenses for most software are designed to take away your freedom to share and change it. By contrast, the GNU General Public License is intended to guarantee your freedom to share and change free software--to make sure the software is free for all its users. This General Public License applies to most of the Free Software Foundation's software and to any other program whose authors commit to using it. (Some other Free Software Foundation software is covered by the GNU Lesser General Public License instead.) You can apply it to your programs, too.

When we speak of free software, we are referring to freedom, not price. Our General Public Licenses are designed to make sure that you have the freedom to distribute copies of free software (and charge for this service if you wish), that you receive source code or can get it if you want it, that you can change the software or use pieces of it in new free programs; and that you know you can do these things.

To protect your rights, we need to make restrictions that forbid anyone to deny you these rights or to ask you to surrender the rights. These restrictions translate to certain responsibilities for you if you distribute copies of the software, or if you modify it.

For example, if you distribute copies of such a program, whether gratis or for a fee, you must give the recipients all the rights that you have. You must make sure that they, too, receive or can get the source code. And you must show them these terms so they know their rights.

We protect your rights with two steps: (1) copyright the software, and (2) offer you this license which gives you legal permission to copy, distribute and/or modify the software.

Also, for each author's protection and ours, we want to make certain that everyone understands that there is no warranty for this free software. If the software is modified by someone else and passed on, we want its recipients to know that what they have is not the original, so that any problems introduced by others will not reflect on the original authors' reputations.

Finally, any free program is threatened constantly by software patents. We wish to avoid the danger that redistributors of a free program will individually obtain patent licenses, in effect making the program proprietary. To prevent this, we have made it clear that any patent must be licensed for everyone's free use or not licensed at all.

The precise terms and conditions for copying, distribution and modification follow.

TERMS AND CONDITIONS FOR COPYING, DISTRIBUTION AND MODIFICATION

0. This License applies to any program or other work which contains a notice placed by the copyright holder saying it may be distributed under the terms of this General Public License. The "Program", below, refers to any such program or work, and a "work based on the Program" means either the Program or any derivative work under copyright law: that is to say, a work containing the Program or a portion of it, either verbatim or with modifications and/or translated into another language. (Hereinafter, translation is included without limitation in the term "modification".) Each licensee is addressed as "you".

Activities other than copying, distribution and modification are not covered by this License; they are outside its scope. The act of running the Program is not restricted, and the output from the Program is covered only if its contents constitute a work based on the Program (independent of having been made by running the Program). Whether that is true depends on what the Program does.

1. You may copy and distribute verbatim copies of the Program's source code as you receive it, in any

medium, provided that you conspicuously and appropriately publish on each copy an appropriate copyright notice and disclaimer of warranty; keep intact all the notices that refer to this License and to the absence of any warranty; and give any other recipients of the Program a copy of this License along with the Program. You may charge a fee for the physical act of transferring a copy, and you may at your option offer warranty protection in exchange for a fee.

2. You may modify your copy or copies of the Program or any portion of it, thus forming a work based on the Program, and copy and distribute such modifications or work under the terms of Section 1 above, provided that you also meet all of these conditions:

- a) You must cause the modified files to carry prominent notices stating that you changed the files and the date of any change.
 - b) You must cause any work that you distribute or publish, that in whole or in part contains or is derived from the Program or any part thereof, to be licensed as a whole at no charge to all third parties under the terms of this License.
 - c) If the modified program normally reads commands interactively when run, you must cause it, when started running for such interactive use in the most ordinary way, to print or display an announcement including an appropriate copyright notice and a notice that there is no warranty (or else, saying that you provide a warranty) and that users may redistribute the program under these conditions, and telling the user how to view a copy of this License. (Exception: if the Program itself is interactive but does not normally print such an announcement, your work based on the Program is not required to print an announcement.)
- These requirements apply to the modified work as a whole. If identifiable sections of that work are not derived from the Program, and can be reasonably considered independent and separate works in themselves, then this License, and its terms, do not apply to those sections when you distribute them as separate works. But when you distribute the same sections as part of a whole which is a work based on the Program, the distribution of the whole must be on the terms of this License, whose permissions for other licensees extend to the entire whole, and thus to each and every part regardless of who wrote it. Thus, it is not the intent of this section to claim rights or contest your rights to work written entirely by you; rather, the intent is to exercise the right to control the distribution of derivative or collective works based on the Program.

In addition, mere aggregation of another work not based on the Program with the Program (or with a work based on the Program) on a volume of a storage or distribution medium does not bring the other work under the scope of this License.

3. You may copy and distribute the Program (or a work based on it, under Section 2) in object code or executable form under the terms of Sections 1 and 2 above provided that you also do one of the following:

- a) Accompany it with the complete corresponding machine-readable source code, which must be distributed under the terms of Sections 1 and 2 above on a medium customarily used for software interchange; or,
- b) Accompany it with a written offer, valid for at least three years, to give any third party, for a charge no more than your cost of physically performing source distribution, a complete machine-readable copy of the corresponding source code, to be distributed under the terms of Sections 1 and 2 above on a medium customarily used for software interchange; or,
- c) Accompany it with the information you received as to the offer to distribute corresponding source code. (This alternative is allowed only for noncommercial distribution and only if you received the program in object code or executable form with such an offer, in accord with Subsection b above.)

The source code for a work means the preferred form of the work for making modifications to it. For an executable work, complete source code means all the source code for all modules it contains, plus any associated interface definition files, plus the scripts used to control compilation and installation of the executable. However, as a special exception, the source code distributed need not include anything that is normally distributed (in either source or binary form) with the major components (compiler, kernel, and so on) of the operating system on which the executable runs, unless that component itself accompanies the executable.

If distribution of executable or object code is made by offering access to copy from a designated place, then offering equivalent access to copy the source code from the same place counts as distribution of the source code, even though third parties are not compelled to copy the source along with the object code.

4. You may not copy, modify, sublicense, or distribute the Program except as expressly provided under this License. Any attempt otherwise to copy, modify, sublicense or distribute the Program is void, and will automatically terminate your rights under this License. However, parties who have received copies, or rights, from you under this License will not have their licenses terminated so long as such parties remain in full compliance.

5. You are not required to accept this License, since you have not signed it. However, nothing else grants you permission to modify or distribute the Program or its derivative works. These actions are prohibited by

law if you do not accept this License. Therefore, by modifying or distributing the Program (or any work based on the Program), you indicate your acceptance of this License to do so, and all its terms and conditions for copying, distributing or modifying the Program or works based on it.

6. Each time you redistribute the Program (or any work based on the Program), the recipient automatically receives a license from the original licensor to copy, distribute or modify the Program subject to these terms and conditions. You may not impose any further restrictions on the recipients' exercise of the rights granted herein. You are not responsible for enforcing compliance by third parties to this License.

7. If, as a consequence of a court judgment or allegation of patent infringement or for any other reason (not limited to patent issues), conditions are imposed on you (whether by court order, agreement or otherwise) that contradict the conditions of this License, they do not excuse you from the conditions of this License. If you cannot distribute so as to satisfy simultaneously your obligations under this License and any other pertinent obligations, then as a consequence you may not distribute the Program at all. For example, if a patent license would not permit royalty-free redistribution of the Program by all those who receive copies directly or indirectly through you, then the only way you could satisfy both it and this License would be to refrain entirely from distribution of the Program.

If any portion of this section is held invalid or unenforceable under any particular circumstance, the balance of the section is intended to apply and the section as a whole is intended to apply in other circumstances. It is not the purpose of this section to induce you to infringe any patents or other property right claims or to contest validity of any such claims; this section has the sole purpose of protecting the integrity of the free software distribution system, which is implemented by public license practices. Many people have made generous contributions to the wide range of software distributed through that system in reliance on consistent application of that system; it is up to the author/donor to decide if he or she is willing to distribute software through any other system and a licensee cannot impose that choice. This section is intended to make thoroughly clear what is believed to be a consequence of the rest of this License.

8. If the distribution and/or use of the Program is restricted in certain countries either by patents or by copyrighted interfaces, the original copyright holder who places the Program under this License may add an explicit geographical distribution limitation excluding those countries, so that distribution is permitted only in or among countries not thus excluded. In such case, this License incorporates the limitation as if written in the body of this License.

9. The Free Software Foundation may publish revised and/or new versions of the General Public License from time to time. Such new versions will be similar in spirit to the present version, but may differ in detail to address new problems or concerns.

Each version is given a distinguishing version number. If the Program specifies a version number of this License which applies to it and "any later version", you have the option of following the terms and conditions either of that version or of any later version published by the Free Software Foundation. If the Program does not specify a version number of this License, you may choose any version ever published by the Free Software Foundation.

10. If you wish to incorporate parts of the Program into other free programs whose distribution conditions are different, write to the author to ask for permission. For software which is copyrighted by the Free Software Foundation, write to the Free Software Foundation; we sometimes make exceptions for this. Our decision will be guided by the two goals of preserving the free status of all derivatives of our free software and of promoting the sharing and reuse of software generally.

NO WARRANTY

11. BECAUSE THE PROGRAM IS LICENSED FREE OF CHARGE, THERE IS NO WARRANTY FOR THE PROGRAM, TO THE EXTENT PERMITTED BY APPLICABLE LAW. EXCEPT WHEN OTHERWISE STATED IN WRITING THE COPYRIGHT HOLDERS AND/OR OTHER PARTIES PROVIDE THE PROGRAM "AS IS" WITHOUT WARRANTY OF ANY KIND, EITHER EXPRESSED OR IMPLIED, INCLUDING, BUT NOT LIMITED TO, THE IMPLIED WARRANTIES OF MERCHANTABILITY AND FITNESS FOR A PARTICULAR PURPOSE. THE ENTIRE RISK AS TO THE QUALITY AND PERFORMANCE OF THE PROGRAM IS WITH YOU. SHOULD THE PROGRAM PROVE DEFECTIVE, YOU ASSUME THE COST OF ALL NECESSARY SERVICING, REPAIR OR CORRECTION.

12. IN NO EVENT UNLESS REQUIRED BY APPLICABLE LAW OR AGREED TO IN WRITING WILL ANY COPYRIGHT HOLDER, OR ANY OTHER PARTY WHO MAY MODIFY AND/OR REDISTRIBUTE THE PROGRAM AS PERMITTED ABOVE, BE LIABLE TO YOU FOR DAMAGES, INCLUDING ANY GENERAL, SPECIAL, INCIDENTAL OR CONSEQUENTIAL DAMAGES ARISING OUT OF THE USE OR INABILITY TO USE THE PROGRAM (INCLUDING BUT NOT LIMITED TO LOSS OF DATA OR DATA BEING RENDERED INACCURATE OR LOSSES SUSTAINED BY YOU OR THIRD PARTIES OR A FAILURE OF THE PROGRAM TO OPERATE WITH ANY OTHER PROGRAMS), EVEN IF SUCH HOLDER OR OTHER

PARTY HAS BEEN ADVISED OF THE POSSIBILITY OF SUCH DAMAGES.

END OF TERMS AND CONDITIONS

How to Apply These Terms to Your New Programs

If you develop a new program, and you want it to be of the greatest possible use to the public, the best way to achieve this is to make it free software which everyone can redistribute and change under these terms.

To do so, attach the following notices to the program. It is safest to attach them to the start of each source file to most effectively convey the exclusion of warranty; and each file should have at least the "copyright" line and a pointer to where the full notice is found.

one line to give the program's name and an idea of what it does.

Copyright (C) yyyy name of author

This program is free software; you can redistribute it and/or modify it under the terms of the GNU General Public License as published by the Free Software Foundation; either version 2 of the License, or (at your option) any later version.

This program is distributed in the hope that it will be useful, but WITHOUT ANY WARRANTY; without even the implied warranty of MERCHANTABILITY or FITNESS FOR A PARTICULAR PURPOSE. See the GNU General Public License for more details.

You should have received a copy of the GNU General Public License along with this program; if not, write to the Free Software

Foundation, Inc., 51 Franklin Street, Fifth Floor, Boston, MA 02110-1301, USA.

Also add information on how to contact you by electronic and paper mail.

If the program is interactive, make it output a short notice like this when it starts in an interactive mode:

Gnomovision version 69, Copyright (C) year name of author

Gnomovision comes with ABSOLUTELY NO WARRANTY; for details

type `show w'. This is free software, and you are welcome

to redistribute it under certain conditions; type `show c'

for details.

The hypothetical commands `show w' and `show c' should show the appropriate parts of the General Public License. Of course, the commands you use may be called something other than `show w' and `show c'; they could even be mouse-clicks or menu items--whatever suits your program.

You should also get your employer (if you work as a programmer) or your school, if any, to sign a "copyright disclaimer" for the program, if necessary. Here is a sample; alter the names:

Yoyodyne, Inc., hereby disclaims all copyright interest in the program `Gnomovision'

(which makes passes at compilers) written

by James Hacker.

signature of Ty Coon, 1 April 1989

Ty Coon, President of Vice

Declaración de conformidad CE

Nosotros, la empresa Intenso GmbH,
con sede social en la Diepholzer Str. 15 en 49377 Vechta, Alemania

declaramos bajo nuestra responsabilidad que el producto:

Modelo: 7" Intenso TAB 734 (Artículo N° 5509854)
Descripción: Ordenador-tableta

cumple con las siguientes directrices y normativas:

Normativa R&TTE 1999/5/CE

- EN 301 489-1 V1.9.2
- EN 301 489-17 V2.1.1
- EN 300 328 V1.7.1 : 2006-10
- EN 55022:2010 (Class B)
- EN 55024:2010
- EN 61000-3-2:2006+A1 :2009+A2 :2009 (Class D)
- EN 61000-3-3:2008

Normativa de baja tensión 2006/95/CE

- EN 60950-1:2006+A11:2009+A1:2010+A12:2011+A12: corrección 2012

Normativa de diseño ecológico 2009/125/CE

- 1275/2008
- 278/2009

Normativa de ROHS 2011/65/EU

Los documentos técnicos relaciones con el dispositivo arriba mencionado han sido depositados en:

Intenso GmbH
Diepholzer Str. 15, 49377 Vechta. Alemania

Persona autorizada:

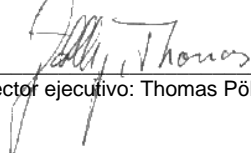

Director ejecutivo: Thomas Pöhking

Manual de instruções TAB 734

Obrigado por ter escolhido o nosso produto **TAB734**. Siga as seguintes orientações, para obter maiores informações sobre este aparelho.



1.) Índice

1.) Índice.....	1
2.) Avisos.....	2
3.) Resumo do aparelho.....	4
4.) Conteúdo da embalagem.....	4
5.) Carregar a bateria.....	5
6.) Utilizar um cartão micro SD/SDHC/SDXC.....	5
7.) Transferência de dados entre o aparelho e o computador.....	5
8.) Ecrã táctil.....	6
9.) WIFI.....	6
Ligação automática.....	6
Conexão manual.....	7
10.) O ecrã inicial.....	8
Visualização.....	8
Desbloquear o ecrã.....	8
Barras de status.....	9
Ajustando a tela principal.....	10
Utilizar diversos ecrãs iniciais.....	10
Aplicações pré-instaladas no ecrã inicial.....	11
11.) Resumo das aplicações.....	11
12.) Enviar / receber emails.....	12
Instalar a conta de e-mail.....	12
Gerenciando uma conta E-mail.....	13
Ver mensagens de e-mail.....	13
Escrever mensagens via e-mail.....	13
13.) Web Browser.....	13
Utilização do teclado virtual.....	14
Inserir símbolos.....	14
Utilização do Web Browser.....	14
14.) Configurações do sistema.....	15
Resumo das principais definições.....	15
15.) Gerir aplicações.....	16
Instalar aplicações.....	16
Desinstalar aplicações.....	16
16.) Ficheiro Explorer.....	17
Navegar por ficheiros e pastas.....	17
Utilizar a barra de ferramentas.....	17
Copiar, mover e renomear ficheiros e pastas.....	17
17.) Condições de garantia limitada.....	18
18.) Dados técnicos.....	18
19.) Manutenção do aparelho.....	19
20.) Limpeza do aparelho.....	19
21.) Eliminação de aparelhos electrónicos fora de uso.....	19
22.) Licença informação.....	20
Declaração de conformidade CE.....	24

Este manual pode eventualmente não conter todas as funções do seu aparelho. Para utilizar aplicações de operadores terceiros, contacte o operador. Por favor note que todas as especificações podem ser alteradas sem pré-aviso. Para informações actuais consulte www.intenso.de

Marca

Google™, e Google™-Logo e Android™ são marcas da Google Inc. Todos os outros nomes de produtos ou serviços pertencem aos respectivos proprietários.

2.) Avisos

- Evite um embate duro do aparelho. Não o coloque em superfícies inclinadas para assim evitar uma queda do aparelho.
- Não utilize o aparelho em zonas extremamente frias, quentes, húmidas ou cheias de pó. Evite também a exposição directa ao sol.
- Evite a utilização em lugares arenosos.
- Não utilize o aparelho em proximidades com risco a explosões, tais como bombas de gasolina.
- Evite a utilização sob almofadas, sofás ou outros objectos que apoiem a criação de calor, pois existe risco de sobre-aquecimento do aparelho.
- Guarde regularmente os seus dados para evitar uma eventual perda de dados. Não somos responsáveis por uma eventual perda de dados.
- Não separe a ligação no momento de transferência de dados ou formatação do aparelho, pois pode causar uma perda de dados.
- Imagens e filmes podem estar protegidos por direitos de terceiros. A reprodução sem licença pode violar direitos de autor.
- Evite a utilização em campos altamente magnetizados.
- Proteja o seu aparelho de humidade. Se entrar humidade no aparelho, desligue-o imediatamente, limpe e seque-o.
- Não utilize soluções químicas para limpar o aparelho. Utilize apenas um pano seco.
- Não posicione chamas abertas, tais como velas acesas, perto ou em cima do aparelho.
- Não somos responsáveis por danos em caso de funcionamento incorrecto, por perda de dados, manuseamento incorrecto, reparações do aparelho ou troca de bateria feitas por mão própria.
- Caso o aparelho não reaja às suas entradas, utilize o botão de repôr no verso do aparelho para o voltar a iniciar.
- Quando não o utilizar, retire o transformador da fonte de energia.
- A tomada deve se encontrar perto do aparelho e ser de fácil acesso.
- Utilize o transformador apenas em tomadas ligadas à terra com AC 100-240V~, 50/60 Hz. Caso não tenha certeza da fonte de energia no local de colocação, consulte o respectivo distribuidor de energia.
- Utilize apenas o transformador e o cabo de ligação à rede fornecidos.
- Para interromper o abastecimento de energia para o seu aparelho, retire o transformador da tomada. Segure o transformador sempre quando o retirar da tomada. Nunca puxe pelo fio.
- Não abra a caixa do adaptador de rede. Em caso de caixa aberta existe perigo de vida devido a choque eléctrico. Não contém peças que requeiram manutenção.
- Em caso de não-utilização durante um longo período, a bateria do aparelho descarrega-se lentamente. Antes de a voltar a utilizar, deve recarregá-la.

- Por favor elimine o aparelho ou a bateria de forma ecológica.
- Por favor não desmonte o aparelho em componentes e não tente repará-lo por si mesmo, pois a garantia expira nesse caso.
- Não utilize o aparelho em locais, onde a utilização de aparelhos móveis seja proibido. Não use o aparelho perto de outros aparelhos eléctricos, pois pode causar interferências devido aos sinais de alta frequência.
- Não utilize o aparelho perto de marca-passos, em hospitais ou perto de aparelhos médicos, pois pode causar interferências devido aos sinais de alta frequência. Mantenha uma distância mínima de 15cm de um marca-passos. Consulte o produtor desses aparelhos para obter informações sobre a utilização comum.
- A utilização de auriculares e auscultadores num volume demasiado alto pode causar danos permanentes no aparelho auditivo. Tenha em conta que um volume constantemente alto pode causar danos auditivos permanentes. Para evitar possíveis riscos para a saúde devido a um volume demasiadamente alto, recomendamos utilizar apenas os auriculares fornecidos.
- Por motivos de segurança no trânsito, o aparelho não deve ser utilizado pelo condutor durante a condução.

3.) Resumo do aparelho

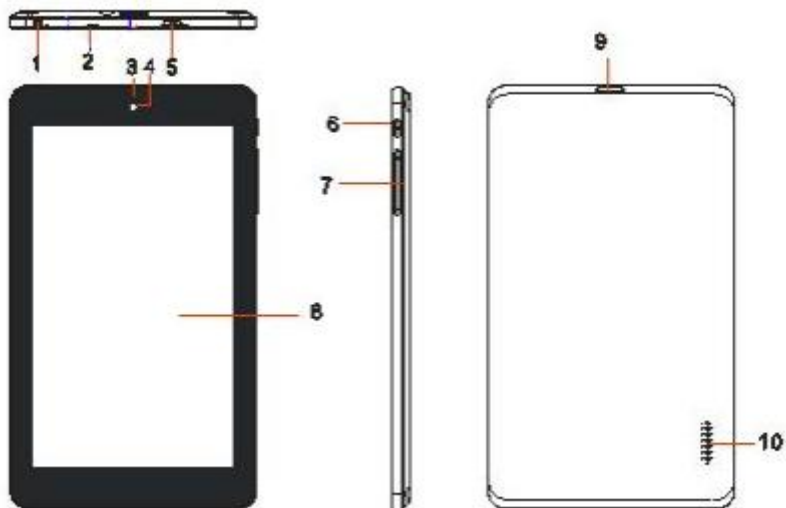

- (1) Conector de auricular 3.5mm
- (2) Microfone integrado
- (3) Indicador de carga: vermelho durante o processo de carga – amarelo se estiver completamente carregada.
- (4) Câmara na frente
- (5) Tomada micro USB

- (6) Botão de ligar / desligar: mantenha premido para desligar o aparelho; premir brevemente para mudar entre standby e modo activo. Tomada micro USB
- (7) Volume + / -
- (8) Touchscreen
- (9) Leitor de cartões micro SD
- (10) Altifalante integrado

4.) Conteúdo da embalagem

Por favor **verifique** se o **conteúdo da embalagem** está **completo**:

- TAB 734
- Auricular Stereo
- Cabo USB
- Transformador 5V 1.2A
- Manual de instruções

5.) Carregar a bateria

Carregue **completamente** a **bateria** do aparelho **antes** da **primeira utilização**. Para tal, **conecte** o **adaptador** com o aparelho e uma **tomada**. O **carregamento completo** demora cerca de **5 horas**. O **estado de carregamento** é indicado na parte da frente do **lado esquerdo** do aparelho. O **LED** fica **vermelho durante o carregamento** e **muda para amarelo** quando a **bateria estiver completamente carregada**.

Notas:

- a. Ao atingir 15% do rendimento restante da bateria, receberá um aviso no ecrã. Deve agora ligar o transformador a uma tomada para carregar a bateria, evitar uma eventual perda de dados e aumentar a duração do transformador.
 - b. Pode utilizar o aparelho enquanto carregar a bateria. No entanto e para garantir uma duração duradoura da bateria, pedimos que não utilize o aparelho.
 - c. Para assegurar um bom rendimento deve utilizar regularmente a bateria integrada. Caso utilizar raramente o aparelho, carregue a bateria pelo menos uma vez por mês completamente.
 - d. Assegure-se que utilize apenas o transformador fornecido para carregar a bateria.
-

6.) Utilizar um cartão micro SD/SDHC/SDXC

Este dispositivo pode ler dados **diretamente** desde um cartão **Micro SD/ SDHC/ SDXC** com uma **capacidade máxima de 64GB**. Para utilizar o cartão **Micro SD/ SDHC/ SDXC**, insira o cartão na respetiva ranhura Micro SD no **lado esquerdo do dispositivo**. Utilize o **explorador pré-instalado** para aceder aos **dados no cartão de memória**. Selecione assim no **explorador** a diretoria „SD Card“.

7.) Transferência de dados entre o aparelho e o computador

Ligue o **aparelho** através do **cabo USB** fornecido a um **computador**

- 1.) No aparelho visualiza-se então o **ecrã** para a **ligação com USB**.
- 2.) Toque **brevemente** em „**activar memória USB**“. O aparelho é reconhecido como **suporte de dados móvel** e recebe a informação „**memória USB em utilização**“. Tocando **brevemente** no botão **Home** permite-lhe **continuar a utilizar** o aparelho **de forma normal**. Desde o **seu computador** tem agora acesso à **memória interna do aparelho** permitindo-lhe **copiar, apagar ou mover** dados no aparelho.
- 3.) Quando houver uma conexão USB no seu computador, aparecerá na barra de tarefas um símbolo USB. A barra de tarefas avançada mostra informações adicionais para ativar e desativar a conexão USB.
 - Para **desativar** o dispositivo de memória, clique sobre “**desativar dispositivo USB**”.
 - Clique sobre a **função “remover hardware com segurança”** , para **remover o dispositivo USB do seu computador**.

Nota: As aplicações pré-instaladas e o sistema operativo Android™ ocupam uma parte da memória. Por essa razão não tem a memória inteira à sua disposição.

8.) Ecrã táctil

Este aparelho é comandado por um **Touchscreen**. Com seus **dedos** poderá **clicar suavemente** no **Touchscreen** para facilmente **iniciar a aplicação, digitar textos em teclado virtual** e **arrastando na respectiva direcção** modificar as **telas principais**.



Por favor **retire a película protectora** do ecrã antes de **utilizar** o aparelho.

O ecrã táctil identifica pequenas **cargas eléctricas**, tais como as emitidas pelo dedo humano e define assim o **ponto de entrada**.

Portanto é preferível utilizar as **pontas dos dedos** para fazer **entradas**. A utilização através de um **lápiz ou outro objecto pontiagudo** não é possível.

O **ecrã táctil não deve entrar em contacto** com água ou outros equipamentos eléctricos para assim evitar um **mau funcionamento e avarias permanentes**.

Nota:

- Caso o ecrã táctil não é utilizado durante dois minutos, o aparelho passa para standby. Prima brevemente na tecla para ligar / desligar para ir para o modo activo.
 - O bloqueio do teclado encontra-se activado automaticamente para evitar entradas indesejadas. Desbloqueie o teclado no ecrã táctil. Toque no cadeado fechado  no mostrador e mantenha-o pressionado. Arraste agora o cadeado para o cadeado aberto  que apareceu agora no mostrador e solte o seu dedo do mostrador. O ecrã está agora desbloqueado.
-

Pode rodar o aparelho para todas as **direcções**, pois possui um **sensor** que **ajusta o ecrã automaticamente**.

9.) WIFI

Necessita de uma ligação **WLAN** para ligar o dispositivo **à internet**. Abra as **definições WLAN**, no **menu definições**, para a configurar.

Nota: Por favor considere que necessita de uma rede de WLAN no alcance da sua posição actual.

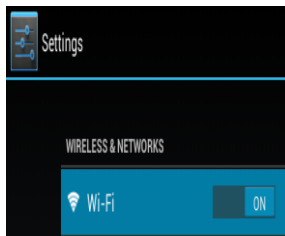

Ligação automática

Abra as definições **WLAN** através do **menu de definições**. Aqui, basta **ativar** ou **desativar** a **função WLAN**. Deslize apenas o botão virtual da **posição "Ligado"** para a esquerda, para **desativar** a função WLAN. Neste momento, o visor **altera-se** para "Desligado". Para voltar a **ativar** ou **desativar** a **função WLAN**, basta deslizar o **botão virtual** para a direita.

Nas **configurações WLAN** são-lhe mostradas, do lado direito, todas as **redes disponíveis**, assim como **todas as redes anteriormente utilizadas**.

Toque na **rede pretendida** e insira caso necessário a **chave de WLAN** (palavra-passe) adequada para **estabelecer uma ligação**.

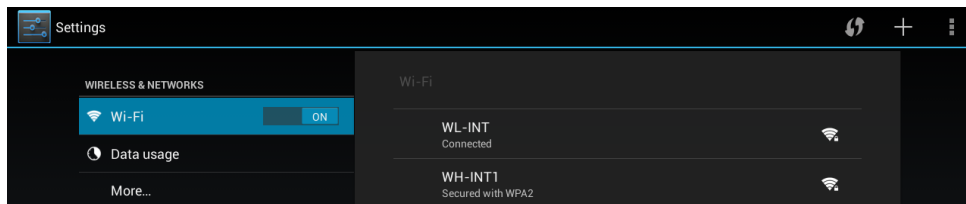

Confirme eventualmente a palavra-passe tocando na **tecla Enter** e toque agora em **conectar**. Após um **breve momento**, a ligação é **estabelecida**.

Notas:

- a) Se o aparelho entrar em standby, o WLAN é automaticamente desactivado, reduzindo assim o consumo de energia e aumentando a duração da bateria. Quando o aparelho voltar para o modo activo, a conexão com o WLAN é reestabelecida automaticamente. Isso pode demorar uns segundos.
 - b) A lista das redes WLAN actualmente disponíveis é actualizada automaticamente.
 - c) Com a função de WLAN activada, o aparelho conecta-se automaticamente a uma rede anteriormente configurada, caso esteja no alcance.
 - d) Caso se encontrar uma rede de WLAN desconhecida no alcance, surge uma informação.
-

Conexão manual

Siga as instruções abaixo para **procurar** uma rede Wi-Fi **acessível**:



- (1) Clique em **configurações**.
- (2) Clique **“configurações Wi-Fi”** e depois clique sobre **“transferir dados”**.
- (3) Se a rede Wi-Fi **não** aparecer na **lista das redes disponíveis**, clique sobre o ponto **“adicionar rede”** e digite manualmente a **rede SSID**, o **protocolo de segurança** e também a sua respectiva **senha**. Para **confirmar** os **dados**, clique sobre **“Salvar”**.

10.) O ecrã inicial

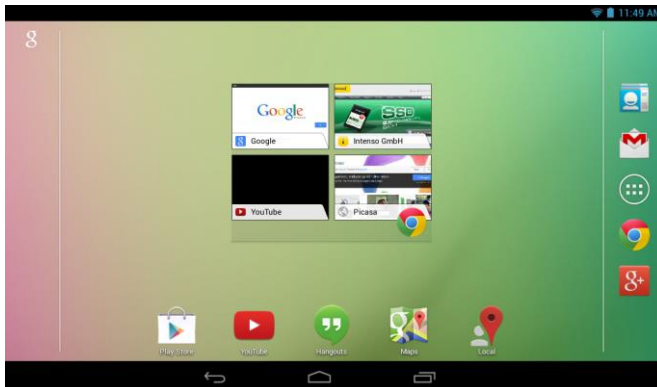
Visualização



Desbloquear o ecrã

Se o ecrã tátil **não for utilizado durante dois minutos**, o aparelho muda para o **modo de espera**. Pressione **brevemente a tecla Ligar / Desligar** para mudar para o **modo ativo**. O **mostrador** está bloqueado para **proteger** de uma **utilização acidental**. Toque no **cadeado fechado**  no mostrador e **mantenha-o pressionado**. Arraste agora o **cadeado aberto**  que apareceu agora no mostrador e **solte** o seu **dedo do mostrador**. O ecrã está agora **desbloqueado**.

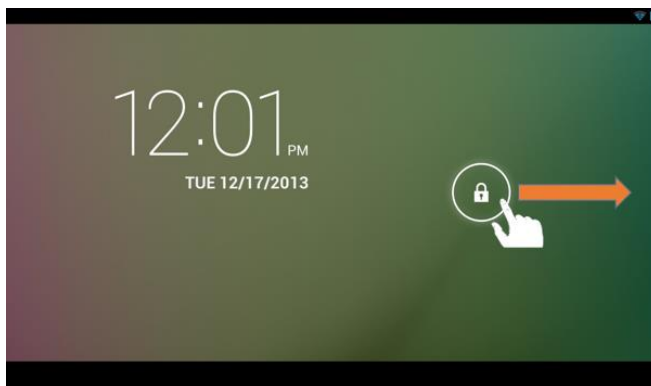

Puxe o símbolo da fechadura com o seu dedo na direcção da seta

Aviso: Arraste o símbolo do cadeado para o símbolo da câmara que apareceu para abrir diretamente a aplicação da câmara.

Barras de status

As **barras de status** encontram-se na parte **superior e inferior do ecrã inicial**.

A **barra superior de status** divide-se em **duas áreas**. Ao puxar a barra no **lado esquerdo** para baixo pode visualizar, caso disponível, os **aviso atuais**.

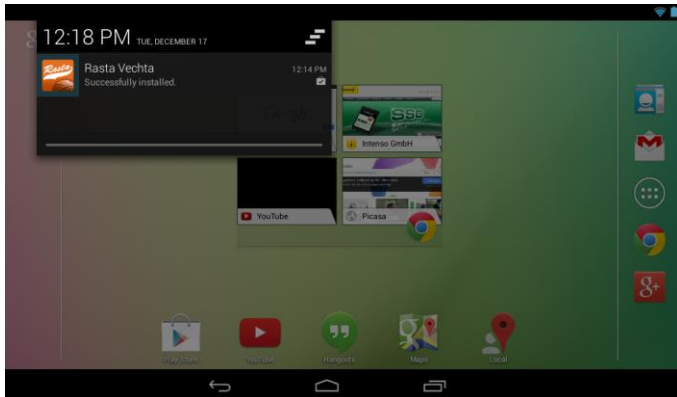

Ao puxar a barra no **lado direito** para baixo, pode visualizar os **campos de acesso rápido** para as **diversas configurações**.

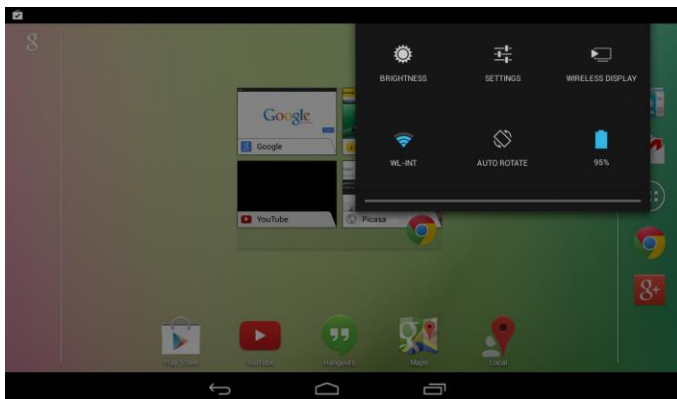

Na **barra de status inferior** tem a possibilidade de voltar para o **ecrã anterior** ou ocultar o teclado eventualmente visualizado, **aceder** diretamente ao **ecrã inicial**, visualizar os **últimos programas utilizados** e **ajustar o volume** do aparelho.



Ajustando a tela principal

É possível ajustar facilmente a **tela principal** de acordo com as **necessidades individuais**. Para **cancelar um ícone**, toque com seus **dedos** por alguns segundos sobre o **ícone** e **arraste-o** até **símbolo X** visualizado. Tire o **dedo do Touchscreen** e o **ícone será cancelado**.

Para **posicionar um ícone da lista de aplicações na tela principal** clique por alguns segundos com o **dedo** sobre o **ícone da aplicação desejada**, que este aparecerá na **tela principal**. **Arraste** o **ícone** para a **posição desejada** e **tire o dedo do Touchscreen**. O **ícone** foi **posicionado** na tela principal. Se um ícone for posicionado sobre outro ícone, automaticamente se abrirá uma pasta com ambos os ícones. Toque a pasta para visualizar os ícones registrados e toque suavemente sobre um ícone para escolher o desejado.

Pode ainda acrescentar **Widgets** ao **menu inicial**. Para fazê-lo, queira abrir a **visão geral da aplicação**. De seguida, toque na palavra **Widgets**. Todos os **Widgets disponíveis no dispositivo** são agora exibidos. **Adicionar um Widget ao menu inicial** é feito da mesma forma que **acrescentar um ícone**.

Para modificar a imagem de fundo, toque sobre um espaço livre da tela inicial e segure com o dedo até aparecer sobre o display o menu de imagens de fundo para escolher uma nova imagem.

Utilizar diversos ecrãs iniciais

É possível **adaptar individualmente**, escolhendo entre as **cinco telas principais** disponíveis. Um simples **movimento de arrastar** com o dedo para a **esquerda ou direita**, poderá **mudar** de uma para a outra.

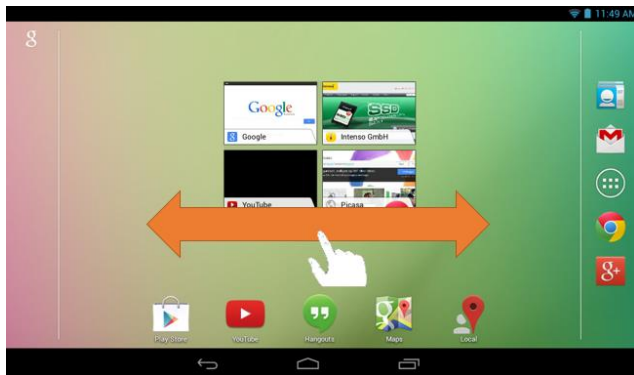

Prima a tecla Home para voltar automaticamente ao ecrã inicial central.

Aplicações pré-instaladas no ecrã inicial

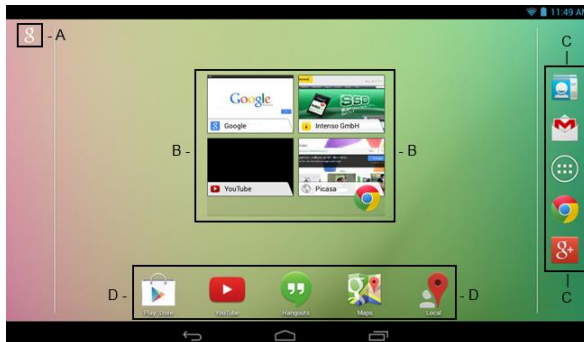

A Atalho para Pesquisa Google™

B Visão geral do marcadores para o navegador Chrome™

C Contactos, Gmail™, Anwendungsübersicht, Chrome™ e Google+™

D Google Playstore™, YouTube™, Hangouts™, Maps™ e Local™

11.) Resumo das aplicações



Toque **brevemente** no **ícone do resumo das aplicações** para abrir o **resumo das aplicações**. Visualiza então um resumo de todas as **aplicações pré-instaladas** e anteriormente **instaladas** por si. Abra a **aplicação pretendida** tocando brevemente no **ícone** correspondente.

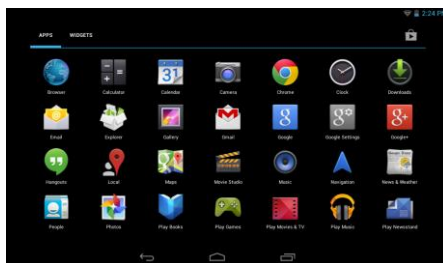

Resumo das aplicações

12.) Enviar / receber emails

A aplicação de **email** está pré-instalada neste aparelho. Esta aplicação permite-lhe utilizar o seu **actual** endereço para **enviar** e **receber** emails.

Nota: Esta função **requer uma ligação WLAN à Internet.**

Abra a aplicação através do ícone „**email** “ no **menu das aplicações.**

Instalar a conta de e-mail

- (1) **Inicie** a aplicação de email tocando no símbolo de **email**. Será convidado/a a instalar a **sua conta de email**.
- (2) Insira o seu **endereço de email** e a **respectiva palavra-passe** e toque em „**continuar**“. A seguir **insira um nome** para a sua **conta** e **defina o nome apresentado para as mensagens enviadas**. Toque em „**terminar**“ para **concluir a configuração**. A sua **conta de email** será seleccionada como **conta geral** se seleccionar a opção **“enviar emails por defeito desde esta conta”**.
- (3) Também pode instalar a sua **conta de email manualmente**. Insira o seu endereço de email e a **respectiva palavra-passe** e toque em **“Configuração manual”** para inserir as **informações do servidor de email**.
- (4) **Selecione** um dos **tipos de servidores POP3, IMAP ou Exchange** para a **recepção** de emails.

Nota: Se não tiver a certeza quais as configurações a efectuar, contacte os fornecedores de serviços de email, o seu administrador de rede ou pesquise na internet por palavras-chave, tais como „**endereço POP**“ e „**nome do seu fornecedor de serviços**“ para obter as **informações requeridas**.



- (5) Insira as **informações** requeridas (servidor, porta, etc.).
- (6) Selecione o tipo de **servidor para emails a enviar** e insira as **informações** requeridas.
- (7) Toque em **“continuar”** para continuar com o **menu**. A aplicação de email verifica então as **configurações do servidor** efectuadas. Concluída **com sucesso a instalação** visualiza-se a mensagem **“Your account is set up, and email is on its way”**. A sua conta está **configurada**.
- (8) Insira um **nome** para a sua **conta** e toque em „**terminar**“ para **concluir** o processo.

Nota: Caso possua mais de uma conta de email, terá acesso à conta geral sempre que iniciar a aplicação de email

Gerenciando uma conta E-mail

Adicionando uma nova conta:

- (1) Abra a **aplicação de E-Mail** e clique sobre a **tecla menu**  para mostrar **outras opções**. Escolha „**configuração**“ e depois **“acrescentar conta”**, para adicionar um novo **endereço**.
- (2) Siga as **instruções de configuração**, para **adicionar um novo endereço**.

Cancelar um endereço:

- (1) Abra a **aplicação de E-Mail** e clique sobre a **tecla menu**  para mostrar **outras opções**. Selecione o ponto "configuração" e depois **“cancelar conta”**, para cancelar o **endereço** desejado.

Verificando as propriedades da conta:

- (1) Abra a **aplicação de E-Mail** e clique sobre a **tecla menu**  para mostrar **outras opções** e selecione „**configuração**“. No **lado esquerdo** do menu irá aparecer, então, **todos os endereços ativados**.
- (2) Clique **sobre o endereço desejado**, para visualizar as propriedades da conta.
- (3) Clique sobre **“propriedades da conta”**, para **completar os registros**.

Ver mensagens de e-mail

Abra a **aplicação de email** tocando brevemente no **ícone de email** para ver a **conta de email criada**.

- Um **movimento vertical** permite-lhe **deslocar-se** pelos seus emails.
- Toque **brevemente** num **email** que pretende abrir.
- **Mantenha** o dedo numa **mensagem de email** para ver **mais opções**. Surge uma **mensagem de informações**. Então pode **abrir, responder, reencaminhar ou apagar emails**.

Escrever mensagens via e-mail

- (1) Clique no **símbolo de E-mail** na **barra superior do menu** e se abrirá uma **nova janela**, onde poderá **escrever um e-mail**.
- (2) Escreva o **endereço de e-mail do destinatário**, um **objeto** e o **texto** nas **respectivas lacunas**. É também possível adicionar **“Cc/Bcc”**, para escrever um e-mail a mais de um destinatário.
- (3) Clique sobre **“enviar”**, para **enviar o e-mail**. Clique sobre **“salvar”**, para **salvar o e-mail digitado como rascunho**. Se clicar sobre o **“símbolo lixeira”**, o **e-mail apenas digitado** será **cancelado**.

13.) Web Browser

Para iniciar o **Web Browser** toque no ícone do **browser**  no ecrã principal.

Insira o **endereço de internet** no **campo superior de entradas** para abrir uma **página da internet**. Surge então o **teclado virtual** para assim poder inserir o **endereço** da **página** pretendida **na internet**. Toque em „**começar**“ ou no **símbolo da seta ao lado do campo de entradas** para abrir a **página da internet**.

Nota: Nem todas as redes fornecem o acesso à internet. Algumas redes oferecem apenas o acesso a outros computadores conectados a nível local, mas não uma ligação à internet.

Utilização do teclado virtual

Toque no **campo de entradas** para aceder ao **teclado virtual**. Pode então **inserir textos** ou **aceder a páginas da internet**.





- Caps Lock (letras maiúsculas ou minúsculas)
- Tecla para voltar
- Aceder ao menu para os números, sinais e entradas de símbolos
- Space Taste (espaço)
- começar (confirmar a sua entrada)

Inserir símbolos

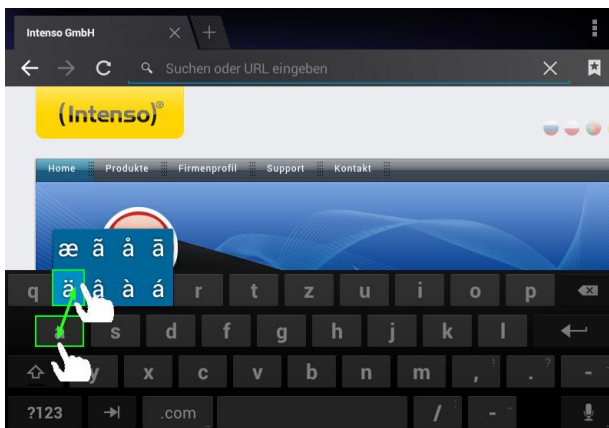
Para digitar símbolos especiais, como por exemplo “ä”, toque por alguns segundos com seus dedos sobre a letra “a”, que aparecerá o **menu dos símbolos especiais**. Deslize o dedo sobre o símbolo desejado, por exemplo, o “ä” e leve-o novamente do display, Assim, o “ä” foi introduzido.





Utilização do Web Browser

- Pode deslocar-se pela **visualização no ecrã** se efectuar um **movimento vertical** com o seu **dedo**. Por favor **não inicie** o movimento num **ponto no menu** ou num **link**, pois pode abrir o **atalho existente**.
- Para abrir um **link na internet** toque simplesmente no **link**. A **página** nova abre **automaticamente**.
- Para abrir o **menu do Web Browser**, clique sobre o **teclado menu** . Serão visualizadas várias funções. Entre elas, é possível **atualizar páginas Web abertas**, **abrir um novo Tab**, **ler as páginas Web off-line** ou mudar as **configurações do Web Browser**.
- Para **voltar** à página **anterior** prima em **voltar** .
- Para voltar **directamente** ao **ecrã inicial** prima em **Home** .
- Para inserir um **texto** toque no **campo correspondente** e utilize o **teclado virtual** para **inserir o texto**.

Nota: Esta função requer uma ligação WLAN à Internet.

14.) Configurações do sistema

Clique no **menu das aplicações** sobre o **ícone de configuração**, para ativar a **configuração do sistema**.

- No **lado esquerdo do menu** estão as localizadas as **categorias**. Clicando **levemente** no respectivo **menu**, irá apareceras **possibilidades de configuração disponíveis**. Considere que, eventualmente, nem todas as funções do Android™ são compatíveis com este aparelho.
- Quando **todas as configurações** tiverem sido completadas, com a **tecla Voltar**  é possível tornar ao **último menu executado**, ou com a **tecla Home**  voltar diretamente **para a tela principal**. As **alterações feitas** serão **salvadas automaticamente**.

Resumo das principais definições

Sem fios & redes	Wi-Fi	Para configurar sua rede Wi-Fi.
	Outros	Outras possibilidades de configuração de rede.
Aparelho	Som	Ajustar o volume desejado e o tom de comunicação desejado. Também é possível ativar e desativar um toque de confirmação tocando o Touchscreen e um toque de notificação para bloquear e desbloquear o display.
	Display	Brilho – Ajustar o nível do brilho da tela. Imagem de fundo – Lista de possíveis imagens de fundo. Stand-by – Ajustar o retardamento para desligar o display automaticamente. Tamanho dos caracteres – Ajustar o tamanho dos caracteres.
	Memória	Informações sobre a memória interna e -caso esteja disponível- do cartão de memória Micro SD. É sempre possível cancelar o conteúdo da memória.
	Bateria	Informações sobre o atual nível da bateria interna.
	Aplicações	Possibilidades de administrar as aplicações instaladas e obter informações sobre as aplicações.
Usuário	Serviço local	Possibilidade de aceitar diversos aplicativos Android, verificar o nível atual de sinal de rede e utilizar a rede (p.ex. Google Maps™). É possível estabelecer se os resultados de busca do Google e outros serviços se adaptam nesta localização.
	Segurança	Ativar e desativar o bloqueio e da tela e outras configurações relevantes à segurança.
	Idioma & Teclado	Seleciona o idioma preferido, adiciona ou edita novas palavras no dicionário pessoal e configura as opções do teclado na tela.
	Salvar & Reposição	Salvar as configurações do sistema e os dados de aplicações em servidores Google. É possível estabelecer a reposição dos dados de fábrica. ATENÇÃO: Todos os dados salvos no aparelho serão perdidos.
Contas	Adicionar conta	Aqui, poderá encontrar diferentes contas.
Sistema	Data & Hora	Ajusta a data, o relógio interno, o fuso horário e seleciona o formato de apresentação.
	Sobre o Tablet	Informações sobre o aparelho.

15.) Gerir aplicações

Aplicações pré-instaladas

Este aparelho é fornecido com **aplicações pré-instaladas**. O **resumo das aplicações**  mostra um **resumo** sobre as **aplicações anteriormente instaladas**. Para **abrir** uma dessas **aplicações** toque **brevemente** no **respectivo ícone**.

Instalar aplicações

Para **instalar aplicações** no aparelho siga os **seguintes passos**:

- (1) Abra o **ficheiro desejado** para fazer **transferência** de **aplicações**. Por exemplo, o **Google Playstore™** previamente instalado. Para fazê-lo, deve iniciar sessão com a sua **conta Playstore™ pré-existente** ou criar uma **nova conta Playstore™**. Basta seguir as **instruções** no ecrã.
- (2) Após o **início de sessão bem-sucedido**, uma grande **seleção de aplicações** do **Google Playstore™** está agora disponível. Selecione a **aplicação desejada**, toque em **instalar** e possivelmente **confirmar** o **acesso autorizado** para esta aplicação. A **transferência** irá agora iniciar e o **progresso** será exibido no canto superior esquerdo da **barra de estado** avançada.
- (3) Após **transferir** a aplicação, esta é automaticamente **instalada**. Pode encontrar a nova **aplicação** no **menu de aplicações**, após a instalação ter sido bem-sucedida. Pode visualizar o **progresso da instalação** no canto superior esquerdo da **barra de estado** avançada.

Desinstalar aplicações





- (1) Abra **configuração do sistema** clicando rápido sobre o **ícone de configuração** na lista de aplicações.
- (2) Clique rapidamente no menu “**Apps**”, para entrar na **configuração das aplicações**.
- (3) Selecione entre um dos pontos “**fazer um download, dispositivo de memória, ativo e todos**” com um leve **toque** a aplicação desejada.
- (4) Então, selecione clicando **rapidamente** sobre a **aplicação** que deve ser **desinstalada**.
- (5) Clique sobre “**desinstalar**” e **confirme** com um **OK**, para que a **aplicação** seja desinstalada do **aparelho**.

Nota: Não é possível de apagar software pré-instalada.

16.) Ficheiro Explorer

Abra o **resumo das aplicações** e toque a seguir brevemente no **ícone do Explorer** para iniciar o **ficheiro Explorer**.

Navegar por ficheiros e pastas

- Tem a **memória interna** (internal Memory), o **cartão de memória** (SD Card) e o **USB** à escolha. Toque no **local de armazenamento pretendido** para visualizar uma lista dos **ficheiros** nele contidos. Caso **não esteja inserido nenhum cartão de memória** ou **nenhum dispositivo de memória** esteja **ligado à conexão de USB** receberá a informação „... is unmounted“.
- Um **movimento vertical** permite-lhe **deslocar-se** entre os ficheiros e as pastas. Abra um **ficheiro** ou uma **pasta** tocando **brevemente**.
- Toque brevemente no respectivo **ícone** para **avançar**  ou **voltar um passo atrás** .
- Para **subir um nível na estrutura dos ficheiros** toque **brevemente** no ícone **LevelUp** .
- O ícone **Home**  permite-lhe ir **directamente** para a **directoria principal**.



Utilizar a barra de ferramentas



Clique sobre a **tecla menu**  e depois sobre „barra de instrumentos escondida“, para visualizar ou não a **barra de instrumentos**

Home	Ir directamente para a directoria principal.
LevelUp	Subir um nível.
Multi	Seleccionar vários ficheiros.
Editor	Copiar, apagar, mover, inserir ou renomear um ficheiro ou uma pasta.
New Folder	Abra um novo directório.
Back	Voltar um passo atrás.
Next	Avançar um passo.

Copiar, mover e renomear ficheiros e pastas

- 1.) **Navegar** para o **ficheiro pretendido** na **listagem dos ficheiros**
- 2.) **Mantenha o dedo** no **ficheiro** até surgir uma **informação**.
- 3.) Selecciona a **função** pretendida. Pode então seleccionar entre **copiar** (Copy), **apagar** (Delete), **mover** (Move), **inserir** (Paste) – o que requer que exista um ficheiro na **memória temporária** - e **renomear** (Rename).
- 4.) Para **copiar** ou **mover** toque brevemente no **ícone correspondente** (Copy / Move) e **navegue** para a **directoria de destino**. Toque a seguir no **ícone do editor**  e seleccione „**colar**“ tocando brevemente para assim **inserir o ficheiro**.
- 5.) Para apagar um **ficheiro** toque brevemente em „**apagar**“ e volte a **confirmar** para a sua segurança com „**apagar**“. Para **cancelar** toque brevemente em „**cancelar**“.
- 6.) Para **renomear** um **ficheiro** toque brevemente em „**renomear**“ e insira a seguir o **novo nome do ficheiro** através do **teclado virtual**. **Confirme** com „**OK**“ ou cancele o processo com „**cancelar**“.
- 7.) **Pode copiar, apagar ou mover vários ficheiros ou pastas simultaneamente**. Toque no ícone **Multi**  e a seguir no **ficheiro pretendido**. Os ficheiros seleccionados são apresentados numa outra cor. Toque no **ícone do Editor**  para efectuar a **acção** pretendida.

17.) Condições de garantia limitada

A garantia cobre apenas a substituição deste produto da Intenso. A garantia não é válida em caso de desgastes normais resultantes de uso inadequado, negligência, acidentes, incompatibilidade ou rendimento insuficiente de um certa hardware ou software de computador.

O direito a garantia expira em caso de não-cumprimento com o manual de instruções da Intenso, bem como em caso de montagem e uso indevido ou defeitos causados por outros aparelhos.

Caso o produto esteja sujeito a vibrações, descargas electrostáticas, influências de calor ou humidade que não estejam incluídas nas especificações do produto, não tem direito a garantia.

A Intenso não se responsabiliza por perda de dados ou danos colaterais ou subsequentes, pela violação das condições de garantia ou outros danos independente das suas causas.

Este produto não se destina ao uso comercial ou a nível medicinal ou especial, nos quais uma falha do produto pode causar lesões, mortes ou elevados danos materiais.

18.) Dados técnicos

CPU	1.0 GHz Dualcore based on Cortex A9
Memória	1 GB DDR 3
Sistema operativo	Android 4.2.2
Sistemas operativos compatíveis	Windows XP / Vista / 7 / 8 / Linux 2,4 e superior / Mac 10.6 e superior
Possibilidades de conectar	Auriculares, Micro SD (SDHC/SDXC), micro USB
WLAN	WiFi (802.11 b/g/n)
G-Sensor	Rotação em 360 graus
Formato de fotografia	JPEG, BMP, GIF, PNG
Formato de audio	MP3, WMA, WAV, OGG, FLAC, APE
Formato de vídeo	MPEG1, MPEG 4, FLV
Ecrã	TFT LCD Display, 1024 x 600 Pixel
Câmara	0,3 MP câmara na frente
SNR	>= 80 dB
Area de frequência	20 Hz – 20 KHz
Transformador	(V) AC Adapter (HUONIO HNBC050120UE): AC Input 100-240V~50/60Hz, DC Output 5V / 1.2A
Bateria integrada	Bateria recarregável de iões-lítio de polímero

19.) Manutenção do aparelho

Nunca borrife ou aplique no ecrã ou na caixa do aparelho algum líquido.

20.) Limpeza do aparelho

Limpe a caixa, a armação e o ecrã com um pano macio que não largue pêlos e que não contenha produtos químicos. Utilize apenas detergentes especiais para o ecrã.

21.) Eliminação de aparelhos electrónicos fora de uso

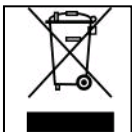

Aparelhos identificados com este símbolo estão sujeitos à Directiva Europeia 2002/96/EC.

Todos os equipamentos eléctricos e electrónicos devem ser separados do lixo doméstico e eliminados pelas respectivas instituições públicas.

A eliminação devida de equipamentos electrónicos evita a poluição do ambiente.

(Intenso)[®]

49377 Vechta
Germany
www.intenso.de



22.) Licença informação

Notice of GNU GENERAL PUBLIC LICENSE and LESSER GENERAL PUBLIC LICENCE

Dear Customer,

If interested, you and any third party can download the source code of used GPL / LGPL from Intenso Webpage <http://www.intenso.de> . The source code of the desired product is available to anyone on the selection of valid product category and the desired device. In the product details you will find the entry "drivers". Open this menu to download the corresponding GPL / LGPL code. For a fee of 35 € (delivery to another country as Germany), it is also possible to obtain this code by postal delivery. More information about the GPL/LGPL-Licence can you find on following website www.gnu.org

GNU GENERAL PUBLIC LICENSE

Version 2, June 1991

Copyright (C) 1989, 1991 Free Software Foundation, Inc.

51 Franklin Street, Fifth Floor, Boston, MA 02110-1301, USA

Everyone is permitted to copy and distribute verbatim copies of this license document, but changing it is not allowed.

Preamble

The licenses for most software are designed to take away your freedom to share and change it. By contrast, the GNU General Public License is intended to guarantee your freedom to share and change free software--to make sure the software is free for all its users. This General Public License applies to most of the Free Software Foundation's software and to any other program whose authors commit to using it. (Some other Free Software Foundation software is covered by the GNU Lesser General Public License instead.) You can apply it to your programs, too.

When we speak of free software, we are referring to freedom, not price. Our General Public Licenses are designed to make sure that you have the freedom to distribute copies of free software (and charge for this service if you wish), that you receive source code or can get it if you want it, that you can change the software or use pieces of it in new free programs; and that you know you can do these things.

To protect your rights, we need to make restrictions that forbid anyone to deny you these rights or to ask you to surrender the rights. These restrictions translate to certain responsibilities for you if you distribute copies of the software, or if you modify it.

For example, if you distribute copies of such a program, whether gratis or for a fee, you must give the recipients all the rights that you have. You must make sure that they, too, receive or can get the source code. And you must show them these terms so they know their rights.

We protect your rights with two steps: (1) copyright the software, and (2) offer you this license which gives you legal permission to copy, distribute and/or modify the software.

Also, for each author's protection and ours, we want to make certain that everyone understands that there is no warranty for this free software. If the software is modified by someone else and passed on, we want its recipients to know that what they have is not the original, so that any problems introduced by others will not reflect on the original authors' reputations.

Finally, any free program is threatened constantly by software patents. We wish to avoid the danger that redistributors of a free program will individually obtain patent licenses, in effect making the program proprietary. To prevent this, we have made it clear that any patent must be licensed for everyone's free use or not licensed at all.

The precise terms and conditions for copying, distribution and modification follow.

TERMS AND CONDITIONS FOR COPYING, DISTRIBUTION AND MODIFICATION

0. This License applies to any program or other work which contains a notice placed by the copyright holder saying it may be distributed under the terms of this General Public License. The "Program", below, refers to any such program or work, and a "work based on the Program" means either the Program or any derivative work under copyright law: that is to say, a work containing the Program or a portion of it, either verbatim or with modifications and/or translated into another language. (Hereinafter, translation is included without limitation in the term "modification".) Each licensee is addressed as "you".

Activities other than copying, distribution and modification are not covered by this License; they are outside its scope. The act of running the Program is not restricted, and the output from the Program is covered only if its contents constitute a work based on the Program (independent of having been made by running the Program). Whether that is true depends on what the Program does.

1. You may copy and distribute verbatim copies of the Program's source code as you receive it, in any

medium, provided that you conspicuously and appropriately publish on each copy an appropriate copyright notice and disclaimer of warranty; keep intact all the notices that refer to this License and to the absence of any warranty; and give any other recipients of the Program a copy of this License along with the Program. You may charge a fee for the physical act of transferring a copy, and you may at your option offer warranty protection in exchange for a fee.

2. You may modify your copy or copies of the Program or any portion of it, thus forming a work based on the Program, and copy and distribute such modifications or work under the terms of Section 1 above, provided that you also meet all of these conditions:

- a) You must cause the modified files to carry prominent notices stating that you changed the files and the date of any change.
 - b) You must cause any work that you distribute or publish, that in whole or in part contains or is derived from the Program or any part thereof, to be licensed as a whole at no charge to all third parties under the terms of this License.
 - c) If the modified program normally reads commands interactively when run, you must cause it, when started running for such interactive use in the most ordinary way, to print or display an announcement including an appropriate copyright notice and a notice that there is no warranty (or else, saying that you provide a warranty) and that users may redistribute the program under these conditions, and telling the user how to view a copy of this License. (Exception: if the Program itself is interactive but does not normally print such an announcement, your work based on the Program is not required to print an announcement.)
- These requirements apply to the modified work as a whole. If identifiable sections of that work are not derived from the Program, and can be reasonably considered independent and separate works in themselves, then this License, and its terms, do not apply to those sections when you distribute them as separate works. But when you distribute the same sections as part of a whole which is a work based on the Program, the distribution of the whole must be on the terms of this License, whose permissions for other licensees extend to the entire whole, and thus to each and every part regardless of who wrote it. Thus, it is not the intent of this section to claim rights or contest your rights to work written entirely by you; rather, the intent is to exercise the right to control the distribution of derivative or collective works based on the Program.

In addition, mere aggregation of another work not based on the Program with the Program (or with a work based on the Program) on a volume of a storage or distribution medium does not bring the other work under the scope of this License.

3. You may copy and distribute the Program (or a work based on it, under Section 2) in object code or executable form under the terms of Sections 1 and 2 above provided that you also do one of the following:

- a) Accompany it with the complete corresponding machine-readable source code, which must be distributed under the terms of Sections 1 and 2 above on a medium customarily used for software interchange; or,
- b) Accompany it with a written offer, valid for at least three years, to give any third party, for a charge no more than your cost of physically performing source distribution, a complete machine-readable copy of the corresponding source code, to be distributed under the terms of Sections 1 and 2 above on a medium customarily used for software interchange; or,
- c) Accompany it with the information you received as to the offer to distribute corresponding source code. (This alternative is allowed only for noncommercial distribution and only if you received the program in object code or executable form with such an offer, in accord with Subsection b above.)

The source code for a work means the preferred form of the work for making modifications to it. For an executable work, complete source code means all the source code for all modules it contains, plus any associated interface definition files, plus the scripts used to control compilation and installation of the executable. However, as a special exception, the source code distributed need not include anything that is normally distributed (in either source or binary form) with the major components (compiler, kernel, and so on) of the operating system on which the executable runs, unless that component itself accompanies the executable.

If distribution of executable or object code is made by offering access to copy from a designated place, then offering equivalent access to copy the source code from the same place counts as distribution of the source code, even though third parties are not compelled to copy the source along with the object code.

4. You may not copy, modify, sublicense, or distribute the Program except as expressly provided under this License. Any attempt otherwise to copy, modify, sublicense or distribute the Program is void, and will automatically terminate your rights under this License. However, parties who have received copies, or rights, from you under this License will not have their licenses terminated so long as such parties remain in full compliance.

5. You are not required to accept this License, since you have not signed it. However, nothing else grants you permission to modify or distribute the Program or its derivative works. These actions are prohibited by

law if you do not accept this License. Therefore, by modifying or distributing the Program (or any work based on the Program), you indicate your acceptance of this License to do so, and all its terms and conditions for copying, distributing or modifying the Program or works based on it.

6. Each time you redistribute the Program (or any work based on the Program), the recipient automatically receives a license from the original licensor to copy, distribute or modify the Program subject to these terms and conditions. You may not impose any further restrictions on the recipients' exercise of the rights granted herein. You are not responsible for enforcing compliance by third parties to this License.

7. If, as a consequence of a court judgment or allegation of patent infringement or for any other reason (not limited to patent issues), conditions are imposed on you (whether by court order, agreement or otherwise) that contradict the conditions of this License, they do not excuse you from the conditions of this License. If you cannot distribute so as to satisfy simultaneously your obligations under this License and any other pertinent obligations, then as a consequence you may not distribute the Program at all. For example, if a patent license would not permit royalty-free redistribution of the Program by all those who receive copies directly or indirectly through you, then the only way you could satisfy both it and this License would be to refrain entirely from distribution of the Program.

If any portion of this section is held invalid or unenforceable under any particular circumstance, the balance of the section is intended to apply and the section as a whole is intended to apply in other circumstances. It is not the purpose of this section to induce you to infringe any patents or other property right claims or to contest validity of any such claims; this section has the sole purpose of protecting the integrity of the free software distribution system, which is implemented by public license practices. Many people have made generous contributions to the wide range of software distributed through that system in reliance on consistent application of that system; it is up to the author/donor to decide if he or she is willing to distribute software through any other system and a licensee cannot impose that choice. This section is intended to make thoroughly clear what is believed to be a consequence of the rest of this License.

8. If the distribution and/or use of the Program is restricted in certain countries either by patents or by copyrighted interfaces, the original copyright holder who places the Program under this License may add an explicit geographical distribution limitation excluding those countries, so that distribution is permitted only in or among countries not thus excluded. In such case, this License incorporates the limitation as if written in the body of this License.

9. The Free Software Foundation may publish revised and/or new versions of the General Public License from time to time. Such new versions will be similar in spirit to the present version, but may differ in detail to address new problems or concerns.

Each version is given a distinguishing version number. If the Program specifies a version number of this License which applies to it and "any later version", you have the option of following the terms and conditions either of that version or of any later version published by the Free Software Foundation. If the Program does not specify a version number of this License, you may choose any version ever published by the Free Software Foundation.

10. If you wish to incorporate parts of the Program into other free programs whose distribution conditions are different, write to the author to ask for permission. For software which is copyrighted by the Free Software Foundation, write to the Free Software Foundation; we sometimes make exceptions for this. Our decision will be guided by the two goals of preserving the free status of all derivatives of our free software and of promoting the sharing and reuse of software generally.

NO WARRANTY

11. BECAUSE THE PROGRAM IS LICENSED FREE OF CHARGE, THERE IS NO WARRANTY FOR THE PROGRAM, TO THE EXTENT PERMITTED BY APPLICABLE LAW. EXCEPT WHEN OTHERWISE STATED IN WRITING THE COPYRIGHT HOLDERS AND/OR OTHER PARTIES PROVIDE THE PROGRAM "AS IS" WITHOUT WARRANTY OF ANY KIND, EITHER EXPRESSED OR IMPLIED, INCLUDING, BUT NOT LIMITED TO, THE IMPLIED WARRANTIES OF MERCHANTABILITY AND FITNESS FOR A PARTICULAR PURPOSE. THE ENTIRE RISK AS TO THE QUALITY AND PERFORMANCE OF THE PROGRAM IS WITH YOU. SHOULD THE PROGRAM PROVE DEFECTIVE, YOU ASSUME THE COST OF ALL NECESSARY SERVICING, REPAIR OR CORRECTION.

12. IN NO EVENT UNLESS REQUIRED BY APPLICABLE LAW OR AGREED TO IN WRITING WILL ANY COPYRIGHT HOLDER, OR ANY OTHER PARTY WHO MAY MODIFY AND/OR REDISTRIBUTE THE PROGRAM AS PERMITTED ABOVE, BE LIABLE TO YOU FOR DAMAGES, INCLUDING ANY GENERAL, SPECIAL, INCIDENTAL OR CONSEQUENTIAL DAMAGES ARISING OUT OF THE USE OR INABILITY TO USE THE PROGRAM (INCLUDING BUT NOT LIMITED TO LOSS OF DATA OR DATA BEING RENDERED INACCURATE OR LOSSES SUSTAINED BY YOU OR THIRD PARTIES OR A FAILURE OF THE PROGRAM TO OPERATE WITH ANY OTHER PROGRAMS), EVEN IF SUCH HOLDER OR OTHER

PARTY HAS BEEN ADVISED OF THE POSSIBILITY OF SUCH DAMAGES.

END OF TERMS AND CONDITIONS

How to Apply These Terms to Your New Programs

If you develop a new program, and you want it to be of the greatest possible use to the public, the best way to achieve this is to make it free software which everyone can redistribute and change under these terms.

To do so, attach the following notices to the program. It is safest to attach them to the start of each source file to most effectively convey the exclusion of warranty; and each file should have at least the "copyright" line and a pointer to where the full notice is found.

one line to give the program's name and an idea of what it does.

Copyright (C) yyyy name of author

This program is free software; you can redistribute it and/or modify it under the terms of the GNU General Public License as published by the Free Software Foundation; either version 2 of the License, or (at your option) any later version.

This program is distributed in the hope that it will be useful, but WITHOUT ANY WARRANTY; without even the implied warranty of MERCHANTABILITY or FITNESS FOR A PARTICULAR PURPOSE. See the GNU General Public License for more details.

You should have received a copy of the GNU General Public License along with this program; if not, write to the Free Software

Foundation, Inc., 51 Franklin Street, Fifth Floor, Boston, MA 02110-1301, USA.

Also add information on how to contact you by electronic and paper mail.

If the program is interactive, make it output a short notice like this when it starts in an interactive mode:

Gnomovision version 69, Copyright (C) year name of author

Gnomovision comes with ABSOLUTELY NO WARRANTY; for details

type `show w'. This is free software, and you are welcome

to redistribute it under certain conditions; type `show c'

for details.

The hypothetical commands `show w' and `show c' should show the appropriate parts of the General Public License. Of course, the commands you use may be called something other than `show w' and `show c'; they could even be mouse-clicks or menu items--whatever suits your program.

You should also get your employer (if you work as a programmer) or your school, if any, to sign a "copyright disclaimer" for the program, if necessary. Here is a sample; alter the names:

Yoyodyne, Inc., hereby disclaims all copyright interest in the program `Gnomovision'

(which makes passes at compilers) written

by James Hacker.

signature of Ty Coon, 1 April 1989

Ty Coon, President of Vice

Declaração de conformidade CE

Nós, a Intenso GmbH,
com sede em Diepholzer Str. 15, 49377 Vechta, Alemanha

declaramos sob a nossa responsabilidade que o produto:

Modelo: 7" TAB 734 (Nº de artigo 5509854)
Descrição: Tablet PC

se encontra em conformidade com as seguintes diretivas e normas:

Diretiva R&TTE 1999/5/EG

- EN 301 489-1 V1.9.2
- EN 301 489-17 V2.1.1
- EN 300 328 V1.7.1 : 2006-10
- EN 55022:2010 (Class B)
- EN 55024:2010
- EN 61000-3-2:2006+A1 :2009+A2 :2009 (Class D)
- EN 61000-3-3:2008

Diretiva de baixa tensão 2006/95/EG

- EN 60950-1:2006+A11:2009+A1:2010+A12:2011+A12: correção 2012

Diretiva de Eco-Design 2009/125/EG

- 1275/2008
- 278/2009

Diretiva de ROHS 2011/65/EU

Os documentos técnicos relativos ao aparelho acima especificado, estão arquivados no seguinte local:

Intenso GmbH
Diepholzer Str. 15, 49377 Vechta, Alemanha

Pessoa autorizada:

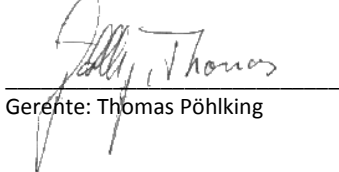

Gerente: Thomas Pöhlking

Instrukcja obsługi TAB 734

Serdecznie dziękujemy za decyzję o korzystaniu z **TAB 734** firmy Intenso. Prosimy o zapoznanie się z tą instrukcją, aby uzyskać informacje o najważniejszych funkcjach tego urządzenia.



1.) Spis treści

1.) Spis treści	1
2.) Ostrzeżenia	2
3.) Widok ogólny urządzenia	4
4.) Zawartość opakowania	4
5.) Ładowanie akumulatora	5
6.) Korzystanie z karty micro SD/SDHC/SDCX	5
7.) Przenoszenie danych pomiędzy urządzeniem a komputerem	5
8.) Ekran dotykowy	6
9.) WIFI	6
Połączenie automatyczne	6
Połączenie ręczne	7
10.) Ekran startowy	8
Widok	8
Odblokowywanie wyświetlacza	8
Listwy stanu	9
Dopasowanie ekranu startowego	10
Używanie różnych ekranów startowych	10
Zainstalowane fabrycznie aplikacje na ekranie startowym	11
11.) Przegląd aplikacji	11
12.) Wysyłanie / odbieranie wiadomości e-mail	12
Konfigurowanie skrzynki e-mail	12
Zarządzanie kontami e-mail	13
Wyświetlanie wiadomości e-mail	13
Pisanie wiadomości e-mail	13
13.) Przeglądarka internetowa	14
Korzystanie z wirtualnej klawiatury	14
Wprowadzanie znaków specjalnych	14
Korzystanie z przeglądarki internetowej	15
14.) Ustawienia systemowe	15
Przegląd ustawień – najważniejsze ustawienia	16
15.) Zarządzanie aplikacjami	17
Instalacja aplikacji	17
Odeinstalowywanie aplikacji	17
16.) Eksplorator plików	18
Nawigacja pomiędzy plikami i folderami	18
Używanie paska narzędzi	18
Kopiowanie, przenoszenie i zmiana nazwy pliku i folderu	18
17.) Warunki ograniczonej gwarancji	19
18.) Dane techniczne	19
19.) Konserwacja urządzenia	20
20.) Czyszczenie urządzenia	20
21.) Utylizacja zużytych urządzeń elektrycznych	20
22.) Licencja informacja	21
Deklaracja zgodności UE	25

Niniejsza instrukcja może nie zawierać opisu wszystkich funkcji Twojego urządzenia. W przypadku korzystania z aplikacji zewnętrznych dostawców, w celu uzyskania informacji prosimy o kontakt z danym dostawcą. Prosimy pamiętać, że wszystkie dane mogą zostać zmienione bez wcześniejszego powiadomienia. Aktualne informacje można znaleźć na stronie www.intenso.de

Znaki firmowe

Google™, logo Google™ i Android™ są markami firmy Google Inc.: Wszystkie inne nazwy produktów i usług są własnością swoich właścicieli.

2.) Ostrzeżenia

- Należy unikać mocnego uderzania urządzenia. Nie należy kłaść urządzenia na pochyłych powierzchniach, aby uniknąć upadku urządzenia.
- Nie należy używać urządzenia w warunkach bardzo niskich lub wysokich temperatur, wysokiej wilgotności lub zapylenia. Nie należy również narażać urządzenia na bezpośrednie promieniowanie słoneczne.
- Należy unikać używania w zapaszczonej miejscach.
- Nie używać urządzenia w miejscach zagrożenia wybuchowego, np. przy dystrybutorach paliwa na stacjach paliw.
- Należy unikać używania na poduszkach, sofach i innych przedmiotach, które wspomagają wytwarzanie ciepła, ponieważ istnieje wtedy niebezpieczeństwo przegrzania urządzenia.
- Należy często przeprowadzać zabezpieczanie danych, aby uniknąć możliwej utraty danych. Nie odpowiadamy za ewentualną utratę danych.
- Nie przerywać połączenia podczas przesyłania danych lub formatowania urządzenia. Może to prowadzić do utraty danych.
- Zdjęcia i filmy mogą być chronione prawami autorskimi osób trzecich. Odtwarzanie bez posiadania licencji może być naruszeniem praw autorskich.
- Należy unikać używania w mocnym polu magnetycznym.
- Należy chronić urządzenie przed wilgocią. Jeśli wilgoć przedostanie się do urządzenia, należy je bezzwłocznie wyłączyć, następnie oczyścić i wysuszyć.
- Do czyszczenia urządzenia nie używać roztworów chemicznych. Proszę używać wyłącznie suchej szmatki.
- W pobliżu lub na urządzeniu nie umieszczać otwartego ognia, np. świec.
- Nie odpowiadamy za szkody powstałe w wyniku wadliwego działania, utraty danych, nieprawidłowej obsługi, samodzielnych napraw urządzenia lub wymiany akumulatora.
- Jeśli urządzenie przestało reagować na próby wprowadzania poleceń, należy użyć znajdujący się z tyłu urządzenia przycisk Reset, aby je ponownie uruchomić.
- W przypadku nieużywania proszę odłączyć zasilacz od źródła zasilania.
- Gniazdko sieciowe musi znajdować się w pobliżu urządzenia i być łatwo dostępne.
- Zasilacz należy podłączać wyłącznie do uziemionych gniazdek sieciowych o napięciu AC 100-240V~, 50/60 Hz. Jeśli nie jesteś pewny parametrów prądu w miejscu, w których korzystasz z urządzenia, to skontaktuj się z odpowiednim dostawcą prądu.
- Należy korzystać wyłącznie z załączonego zasilacza i przewodu sieciowego.
- Aby przerwać zasilanie urządzenia, należy wyjąć zasilacz z gniazdka sieciowego. Podczas wyciągania należy zawsze chwytać bezpośrednio zasilacz. Nigdy nie ciągnąć za przewód.
- Nie otwierać obudowy zasilacza. Otwarta obudowa stwarza zagrożenie dla życia spowodowane porażeniem elektrycznym. Zasilacz nie zawiera części podlegających konserwacji.

- Podczas dłuższe nieużywania akumulator urządzenia powoli się rozładowuje. Przed ponownym użyciem konieczne jest jego ponowne naładowanie.
- Proszę zwrócić uwagę na niestanowiącą zagrożenia dla środowiska utylizację urządzenia lub akumulatora.
- Proszę nie rozbierać urządzenia na podzespoły, ani nie próbować go samodzielnie naprawiać, gdyż w takim przypadku wygasa gwarancja.
- Nie używać urządzenia w miejscach, w których obowiązuje zakaz używania urządzeń przenośnych. Nie używać urządzenia w pobliżu innych urządzeń elektronicznych, gdyż w wyniku sygnałów wysokiej częstotliwości może dojść do zakłóceń.
- Nie używać urządzenia w pobliżu rozruszników serca, w szpitalach lub w pobliżu urządzeń medycznych, ponieważ w wyniku sygnałów wysokiej częstotliwości może dojść do zakłóceń. Należy utrzymywać odstęp min. 15 cm od rozruszników serca. Proszę zwrócić się do producentów tych urządzeń, aby uzyskać informacje dotyczące jednoczesnego ich używania.
- Korzystanie ze słuchawek nausznych lub dousznych przy zbyt dużej głośności może doprowadzić do stałego uszkodzenia organów słuchu. Prosimy zwrócić uwagę, że długotrwałe oddziaływanie wysokiej głośności może prowadzić do trwałego uszkodzenia słuchu. Aby uniknąć możliwego ryzyka zdrowotnego spowodowanego przez wysoką głośność, zalecamy używanie wyłącznie zawartych w zestawie słuchawek.
- Ze względu na bezpieczeństwo ruchu podczas jazdy urządzenie nie może być obsługiwane przez osobę prowadzącą pojazd.

3.) Widok ogólny urządzenia

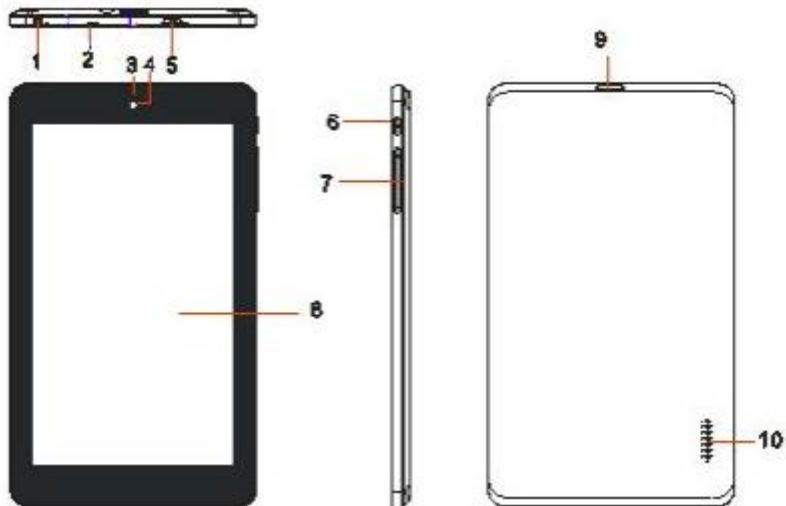

- (1) Gniazdo słuchawek 3,5mm
- (2) Zintegrowany mikrofon
- (3) Kontrolka ładowania: czerwona podczas ładowania, żółta kiedy całkowicie naładowana.
- (4) Kamera przednia
- (5) Gniazdo micro USB

- (6) Przycisk WŁ./WYŁ.: Przcisnąć długo, aby wyłączyć urządzenie, przycisnąć krótko, aby zmieniać pomiędzy trybami czuwania i pracy. Gniazdo micro USB
- (7) Głośność + / -
- (8) Ekran dotykowy
- (9) Gniazdo karty Micro SD
- (10) Zintegrowane głośniki

4.) Zawartość opakowania

Proszę **sprawdzić kompletność zawartości opakowania:**

- TAB 734
- słuchawki stereo
- przewód USB
- zasilacz 5V 1.2A
- Instrukcja obsługi

5.) Ładowanie akumulatora

Proszę **przed** pierwszym użyciem całkowicie naładować akumulator urządzenia. W tym celu należy połączyć załączony zasilacz z urządzeniem i gniazdem sieciowym. Pełne ładowanie trwa ok. 5 godzin. Stan naładowania wyświetlany jest z przodu, po lewej stronie urządzenia. Dioda LED świeci się podczas ładowania na czerwono i świeci na żółto, kiedy kiedy akumulator jest w pełni naładowany.

Wskazówki:

- a. Przy 15% pozostającej mocy akumulatora na wyświetlaczu pojawi się ostrzeżenie. W takiej sytuacji powinno się podłączyć urządzenie poprzez zasilacz z gniazdkiem sieciowym w celu naładowania akumulatora, aby uniknąć ewentualnej utraty danych i podnieść żywotność akumulatora.
 - b. Z urządzenia można korzystać podczas ładowania akumulatora. Aby zachować jak najdłuższą żywotność akumulatora, prosimy o nie korzystanie z urządzenia.
 - c. Aby zapewnić jak najlepszą wydajność, konieczne jest częste korzystanie z wbudowanego akumulatora. Jeśli urządzenie jest rzadko używane, to proszę przynajmniej raz w miesiącu w pełni naładować akumulator.
 - d. Należy zapewnić, że używany jest wyłącznie dostarczony z urządzeniem zasilacz.
-

6.) Korzystanie z karty micro SD/SDHC/SDXC

Urządzenie to może odczytywać dane bezpośrednio z karty Micro SD/SDHC/SDXC Karte o maksymalnej pojemności 64 GB. Aby używać karty Micro SD/SDHC/SDXC, należy włożyć tę kartę do przeznaczonego do tego dnia Micro SD po lewej stronie urządzenia.

Aby uzyskać dostęp do danych zapisanych na karcie pamięci należy skorzystać z zainstalowanego fabrycznie Eksploratora. Należy w tym celu wybrać w Eksploratorze folder „SD Card”.

7.) Przenoszenie danych pomiędzy urządzeniem a komputerem

- 1.) Urządzenie połączyć za pomocą załączonego przewodu USB z komputerem
- 2.) Na urządzeniu wyświetlony zostanie ekran połączenia USB. Należy krótko nacisnąć na „Aktywowanie pamięci USB”. Urządzenie zostanie rozpoznane jako wymienny nośnik pamięci i wyświetlona zostanie informacja „Pamięć USB w użyciu”. Po krótkim naciśnięciu na przycisk Home można normalnie korzystać z urządzenia. Teraz posiadasz dostęp ze swojego komputera do wewnętrznej pamięci urządzenia i możesz kopiować, usuwać lub przenosić pliki na urządzenie.
- 3.) Jeśli istnieje połączenie USB z komputerem, to w pasku stanu wyświetla się symbol USB. W rozszerzonym pasku stanu wyświetlane są dodatkowe informacje oraz można aktywować wzgl. deaktywować połączenie USB.
 - Aby deaktywować nośnik danych, należy wybrać opcję „Deaktywuj pamięć USB”.
 - Na komputerze należy wybrać funkcję „Bezpieczne usuwanie” , aby odłączyć urządzenie od komputera.

Wskazówka: Fabrycznie zainstalowane aplikacje oraz system operacyjny Android™ zajmują część zainstalowanej pamięci wewnętrznej. Z tego powodu do dyspozycji nie jest dostępna całość wewnętrznej pamięci.

8.) Ekran dotykowy



Urządzenie jest sterowane za pomocą **ekranu dotykowego**. **Delikatnie naciskając palcem na ekran dotykowy** można bardzo łatwo **uruchamiać aplikacje, wpisywać teksty za pomocą wirtualnej klawiatury** i przez **przesuwanie palcem w odpowiednim kierunku** przełączać pomiędzy **pojedynczymi ekranami startowymi**.

Proszę **usunąć folię ochronną wyświetlacza** przed **użyciem** urządzenia.

Ekran dotykowy rozpoznaje drobne **ładunki elektryczne**, jak na przykład te przekazywane przez ludzki palec i **ustala** w ten sposób **punkt wprowadzania**. Do **wprowadzania** najlepiej więc używać **opuszków palców**. Obsługa za pomocą **pisaka lub innego ostro zakończonego przedmiotu** jest niemożliwa.

Ekran dotykowy nie powinien mieć kontaktu z wodą lub innymi urządzeniami elektrycznymi, aby **uniknąć błędnego działania i trwałych uszkodzeń**.

Wskazówki:

- Jeśli ekran dotykowy nie jest obsługiwany przez dwie minuty, to urządzenie przechodzi w tryb czuwania. Aby przejść w tryb aktywny, należy krótko nacisnąć przycisk WŁ./WYŁ.
 - Aby uniemożliwić niezamierzone wprowadzanie, aktywowana jest automatyczny blokada przycisków. Blokadę proszę odblokować na ekranie dotykowym. Dotknij na wyświetlaczu zamkniętej kłódki  i przytrzymaj ją naciśniętą. Przeciągnij teraz tę kłódkę na właśnie wyświetloną otwartą kłódkę  i następnie cofnij swój palec z wyświetlacza. Ekran jest teraz odblokowany.
-

Urządzenie można obracać we **wszystkie strony**. Jest ono wyposażono w **czujnik**, który **automatycznie dostosowuje wyświetlacz**.

9.) WIFI

Aby połączyć urządzenie z **Internetem**, konieczne jest połączenie z **siecią bezprzewodową**.

Wskazówka: Należy zwrócić uwagę, że w bieżącej pozycji konieczny jest zasięg sieci bezprzewodowej.

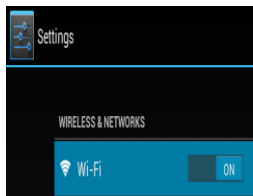

Połączenie automatyczne

W opcji **Einstellungen (Ustawienia)** proszę wybrać opcję **WLAN Einstellungen (Ustawienia sieci bezprzewodowej)**. W tym miejscu można w prosty sposób **włączyć** lub **wyłączyć funkcję sieci bezprzewodowej**. Aby **wyłączyć** sieć bezprzewodową należy przesunąć **wirtualny przełącznik** z pozycji „An“ („sieć włączona”) w lewo. Teraz wskazanie na wyświetlaczu **zmeni się** na „Aus“ („sieć wyłączona”). Aby ponownie **włączyć wyłączoną funkcję sieci bezprzewodowej** wystarczy przesunąć **wirtualny przełącznik** w prawo.

W **ustawieniach Wi-Fi** po prawej stronie wyświetlane są wszystkie **dostępne sieci** oraz **wszystkie sieci, z których dotąd korzystano**.

Teraz należy nacisnąć na **wybraną sieć** i wprowadzić odpowiednie **hasło sieciowe**, aby **ustanowić połączenie**.

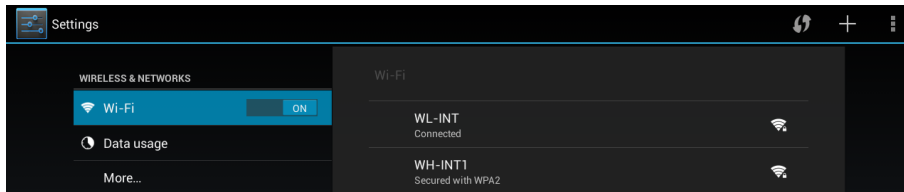

Potwierdź ewentualnie wprowadzone hasło naciskając **przycisk Enter** i naciśnij krótko na **Połącz**. Po **krótkiej chwili połączenie zostanie ustanowione**.

Wskazówki:

- a) Kiedy urządzenie przechodzi w tryb czuwania, to połączenie z siecią bezprzewodową jest automatycznie deaktywowane. Ogranicza to zużycie prądu i prowadzi w ten sposób automatycznie do dłuższej pracy akumulatora. Kiedy urządzenie ponownie przelączy się w tryb aktywny, to połączenie z siecią bezprzewodową zostaje automatycznie odnowione. Może to trwać kilka sekund.
 - b) Lista aktualnie dostępnych sieci bezprzewodowych jest automatycznie aktualizowana.
 - c) Kiedy aktywna jest funkcja sieci bezprzewodowej, to urządzenie automatycznie łączy się z już skonfigurowaną siecią, jeśli znajduje się w jej zasięgu.
 - d) Jeśli w zasięgu znajduje się nieznana sieć bezprzewodowa, to wyświetlane jest pole informacyjne.
-

Połączenie ręczne

Aby ręcznie **wyszukać dostępną** sieć bezprzewodową, należy postępować następująco:



- (1) Należy nacisnąć na **ikonę WiFi** na **stronie startowej** albo w **przeglądzie aplikacji**.
- (2) Następnie należy otworzyć **ustawienia sieci bezprzewodowej** oraz **podmenu**. W tym celu należy nacisnąć na **symbol menu**  i wybrać w **wyświetlonym menu punkt „Scan”**.
- (3) Jeśli sieć bezprzewodowa **nie** została wyświetlona na **liście dostępnych sieci**, należy przewinąć w dół i **wybrać punkt „Dodaj sieć bezprzewodową”**, aby ręcznie wprowadzić **SSID sieci, protokół zabezpieczeń i przynależne hasło**. Aby **potwierdzić wprowadzone dane** należy nacisnąć na **„Zapisz”**.

10.) Ekran startowy

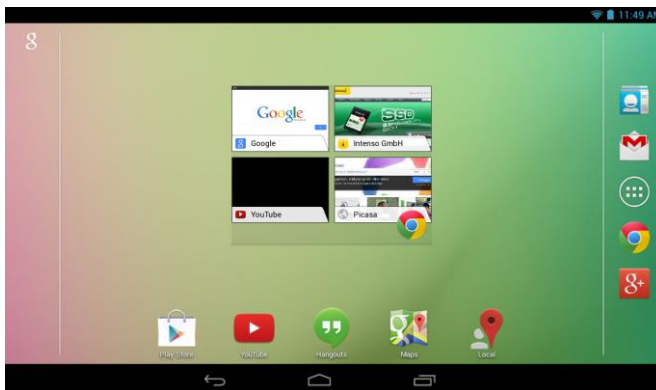
Widok



Odblokowywanie wyświetlacza

Jeśli ekran dotykowy **nie jest obsługiwany przez dwie minuty**, to urządzenie przechodzi w **tryb czuwania**. Aby przejść w **tryb aktywny**, należy **krótko nacisnąć przycisk WŁ./WYŁ.** Wyświetlacz jest zablokowany w celu **ochrony przed niezamierzonym wprowadzaniem**. Dotknij na wyświetlaczu **zamkniętej kłódki**  i **przytrzymaj ją naciśniętą. Przeciągnij** teraz tę **klódkę** na właśnie wyświetloną **otwartą kłódkę**  i następnie **cofnij** swój **palec** z **wyświetlacza**. Ekran jest teraz **odblokowany**.

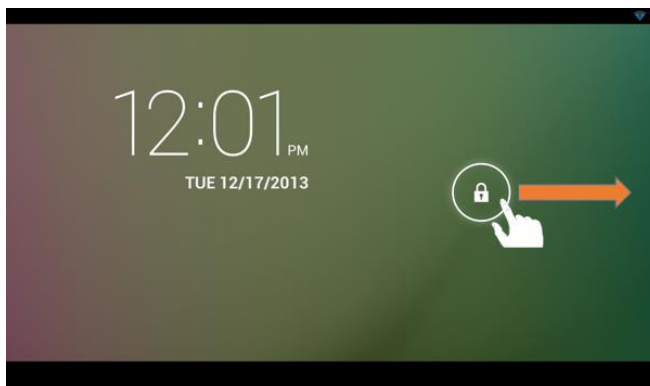

Pociągnij palcem symbol kłódki zgodnie z kierunkiem strzałki.

Wskazówka: Przeciągnij symbol kłódki na wyświetlony symbol kamery, aby bezpośrednio otworzyć aplikację aparatu fotograficznego.

Listwy stanu

Listwy stanu znajdują się w **górnym** i **dolnym** obszarze ekranu startowego.

Górna lista stanu podzielona jest na **dwa obszary**. Pociągnięcie w dół **lewej strony** powoduje wyświetlenie, jeśli występują, **aktualnych powiadomień**.

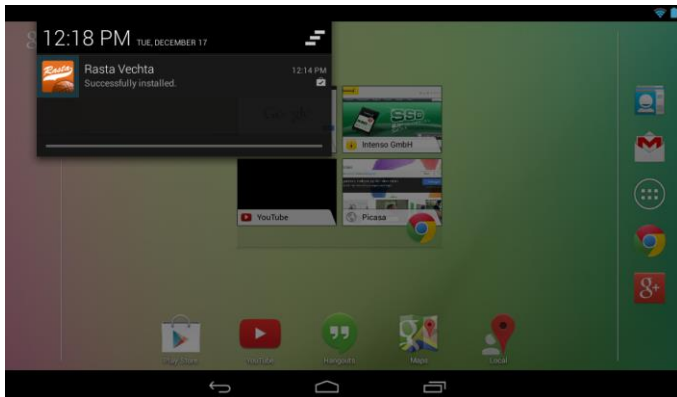

Pociągnięcie **prawej strony** powoduje wyświetlenie **pól szybkiego dostępu** różnych ustawień.

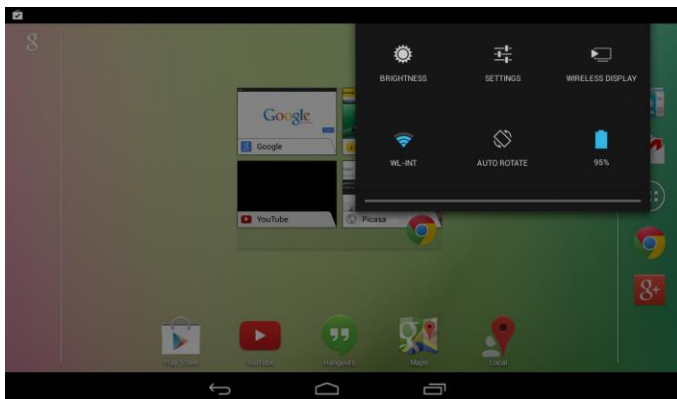

W **dolnej liście stanu** istnieje możliwość powrotu do **poprzedniego ekranu**, lub **wyłączenia** ewentualnie wyświetlanej **klawiatury**, bezpośredniego przejścia do **ekranu startowego**, wyświetlenia **ostatnio używanych programów** oraz **regulacji głośności** urządzenia.



Dopasowanie ekranu startowego

Ekran startowy można bardzo łatwo dopasować do swoich **indywidualnych potrzeb**. Aby **usunąć ikonę**, należy trochę **dłużej nacisnąć palcem** na tę **ikonę** i **przeciagnać** ją do wyświetlonego **symbol X**. Teraz należy puścić **palec z ekranu dotykowego** i **ikona zostanie usunięta**.

Aby **umieścić ikonę z przeglądu aplikacji na ekranie startowym**, należy nacisnąć w **przeglądzie aplikacji** trochę **dłużej** na wybraną **ikonę** i wyświetli się **ekran startowy**. Należy teraz **przesunąć tę ikonę** na **wybrane miejsce** i **puścić palec z ekranu dotykowego**. **Ikona została dodana** do ekranu startowego. Jeśli na ikonę położy się inną ikonę, to automatycznie założony zostanie folder zawierający obie ikony. Naciśnięcie na folder powoduje wyświetlenie wszystkich zawartych w nim ikon i umożliwia po przez krótkie naciśnięcie wybór dowolnej ikony.

Ponadto na **ekranie powitalnym** można dodawać różne widżety. W tym celu należy wywołać opcję **Anwendungsübersicht („Przegląd aplikacji”)**, a następnie kliknąć na słowo **Widgets (widżety)**. Teraz zostaną wyświetlone wszystkie **widżety dostępne na urządzeniu**. Aby dodać nowy **widżet** do ekranu powitalnego należy postępować w taki sam sposób, jak w przypadku **dodawania ikony**.

Aby zmienić tło pulpitu, należy po prostu nacisnąć na wolne miejsce na ekranie startowym i przytrzymać palec tak długo na wyświetlaczu, aż wyświetli się menu wyboru tła pulpitu.

Używanie różnych ekranów startowych

Dostępnych jest **pięć ekranów startowych do indywidualnego skonfigurowania**. Poprzez **lekki ruch przesunięcia w lewo lub prawo** można bardzo łatwo pomiędzy nimi **przełączać**.

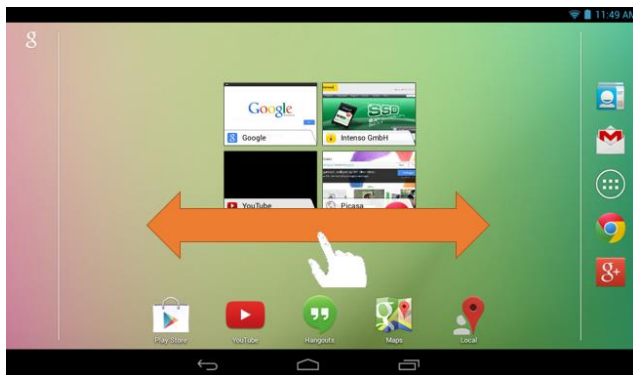

Naciśnięcie przycisku Home powoduje automatyczny powrót do środkowego ekranu startowego.

Zainstalowane fabrycznie aplikacje na ekranie startowym

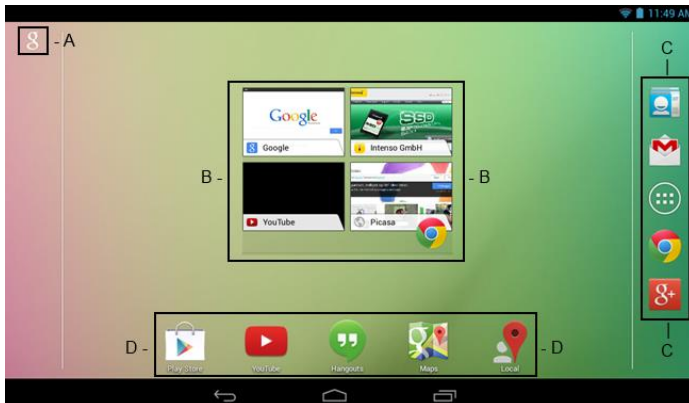

- A Skrót klawiszowy wyszukiwania Google™
- B Zakładka Informacje dla przeglądarki Chrome™
- C Kontakty, Gmail™, Przegląd aplikacji, Chrome™ i Google+™
- D Google Playstore™ , YouTube™ , Hangouts™ , Maps™ i Local™

11.) Przegląd aplikacji



Naciskając krótko na ikonę przeglądu aplikacji otwiera się przegląd aplikacji. Wyświetlony zostanie przegląd wszystkich aplikacji zainstalowanych fabrycznie i przez użytkownika. Wybraną aplikację otwiera się po przez krótkie naciśnięcie odpowiedniej ikony.



Przegląd aplikacji

12.) Wysyłanie / odbieranie wiadomości e-mail

Na tym urządzeniu zainstalowana jest fabrycznie **aplikacja e-mail**. Używając jej można **korzystać** z już istniejącego **adresu e-mail**, aby **wysyłać** i **odbierać** wiadomości e-mail.

Wskazówka: Ta funkcja wymaga połączenia poprzez sieć bezprzewodową z Internetem.

Aplikację tę otwiera się używając **ikony „e-mail”**, która znajduje się w **menu aplikacji**.

Konfigurowanie skrzynki e-mail

- (1) **Naciskając** na symbol **e-mail** należy **uruchomić** aplikację e-mail. Wyświetlona zostanie prośba o **skonfigurowanie skrzynki e-mail**.
- (2) Należy wpisać swój **adres e-mail** oraz **odpowiednie hasło** i następnie nacisnąć **„Dalej”**. Następnie należy **nazwać** swoje **konto** i **ustawić nazwę wyświetlaną dla wiadomości wychodzących**. Aby **zakończyć konfigurację** należy nacisnąć **„Gotowe”**. **Skrzynka e-mail** zostaje wybrana jako **skrzynka standardowa**, jeśli wybrana została opcja **„Wiadomości e-mail wysyłaj standardowo z tego konta”**.
- (3) **Skrzynka e-mail** może być również konfigurowana **ręcznie**. W tym celu należy wprowadzić **adres e-mail** i **odpowiednie hasło** i nacisnąć **następnie** na **„Ręczna konfiguracja”**, aby wprowadzić **dane serwerów e-mail**.
- (4) Należy **wybrać** spośród **serwerów typu POP3, IMAP lub Exchange** dla poczty **przychodzącej**.

Wskazówka: Jeśli nie wiesz, jakie masz wybrać ustawienia, to skontaktuj się z Twoim dostawcą usługi e-mail, Twoim administratorem sieci lub wyszukaj niezbędne informacje w Internecie używając np. pojęć „adres POP” i „nazwa Twojego dostawcy”.



- (5) Wprowadź **dane** (serwer, port itd.).
- (6) Teraz należy wybrać **typ serwera dla poczty wychodzącej** i wprowadzić **niezbędne dane**.
- (7) Aby **przejsć dalej w menu**, należy nacisnąć **„Dalej”**. Aplikacja e-mail **sprawdzić** teraz wprowadzone **ustawienia serwerów**. Po **udanej konfiguracji** wyświetlony zostanie komunikat **„Your account is set up, and email is on its way”**. Konto jest teraz **skonfigurowane**.
- (8) Teraz należy **nazwać skrzynkę pocztową** i nacisnąć na **„Gotowe”**, aby **zakończyć** proces.

Wskazówka: Jeśli posiadasz więcej kont e-mail, to przy każdym uruchomieniu aplikacji e-mail wywoływane będzie konto standardowe.

Zarządzanie kontami e-mail

Dodawanie nowej skrzynki pocztowej:

- (1) Należy otworzyć **aplikację e-mail** i nacisnąć **przycisk Menu**  aby wyświetlić **dalsze opcje**. Aby założyć nową **skrzynkę pocztową**, należy wybrać punkt menu „**Ustawienia**” i następnie „**Dodaj konto**”.
- (2) Następnie należy postępować zgodnie z poleceniami **kreatora**, aby **założyć nową skrzynkę pocztową**.

Usuwanie skrzynki pocztowej:

- (1) Należy otworzyć **aplikację e-mail** i nacisnąć **przycisk Menu**  aby wyświetlić **dalsze opcje**. Aby założyć usunąć **skrzynkę pocztową**, należy wybrać punkt menu „**Ustawienia**” i następnie „**Usuń konto**”.

Sprawdzanie właściwości konta:

- (1) Należy otworzyć **aplikację e-mail** i nacisnąć **przycisk Menu**  aby wyświetlić **dalsze opcje** oraz należy wybrać opcję „**Ustawienia**”. Po **lewej stronie** menu wyświetlone teraz zostaną **wszystkie** już **założone skrzynki pocztowe**.
- (2) Aby wyświetlić ustawienia konta, należy nacisnąć **na wybraną skrzynkę pocztową**.
- (3) Aby wprowadzić zmiany, należy nacisnąć „**Ustawienia konta**”.

Wyświetlanie wiadomości e-mail

Przez **krótkie** naciśnięcie na **ikonę e-mail** otwiera się **aplikację e-mail**. Wyświetlona zostanie **już założona skrzynka pocztowa**.

- **Pionowym ruchem przesunięcia** można **przewijać** wiadomości e-mail.
- Aby **otworzyć konkretną wiadomość e-mail**, należy **krótko** na nią nacisnąć.
- Aby wyświetlić **dotatkowe opcje** należy nacisnąć i **przytrzymać konkretną wiadomość e-mail**. Wyświetlone zostanie **pole informacyjne**. Tutaj można teraz **otworzyć, odpowiedź na, przesłać dalej** lub **usunąć wiadomość e-mail**.

Pisanie wiadomości e-mail

- (1) W widoku ogólnym e-maili należy nacisnąć **symbol e-mail** w **górnym pasku menu** i otwarte zostanie **nowe okno**, w którym można **utworzyć nową wiadomość e-mail**.
- (2) Teraz należy wpisać **adres e-mail odbiorcy, temat** i **tekst** w **przeznaczonych do tego polach**. Można również dodać odbiorców „**DW/UDW**”, aby wysłać wiadomość do kilku użytkowników.
- (3) Aby **wysłać wiadomość e-mail**, należy nacisnąć na „**Wyślij**”. Naciskając na „**Zapisz**”, zapisuje się **wiadomość e-mail jako wersję roboczą**. Jeśli naciśnie się na **symbol kosza**, to **wprowadzana właśnie wiadomość e-mail** zostanie **usunięta**.

13.) Przeglądarka internetowa

Aby uruchomić **przeglądarkę internetową** należy nacisnąć na **ikonę Przeglądarka**  na **ekranie startowym**.

Aby otworzyć **stronę internetową**, należy nacisnąć na **górną pole wprowadzania adresu internetowego**. **Wirtualna klawiatura** otworzy się i można wpisać **adres wybranej strony internetowej**. Następnie należy nacisnąć przycisk „**Przejdź**” lub **symbol strzałki obok pola wprowadzania**, aby otworzyć tę **stronę internetową**.

***Wskazówka:** Nie wszystkie sieci zapewniają dostęp do Internetu. Niektóre sieci zapewniają jedynie dostęp do podłączonych serwerów lokalnych, a nie połączenie z Internetem.*

Korzystanie z wirtualnej klawiatury

Aby otworzyć **wirtualną klawiaturę** należy nacisnąć na **pole wprowadzania**. Teraz można **wprowadzać tekst** lub **wywołać strony internetowe**.





- Caps Lock (pisanie dużych i małych liter)
- Backspace (cofnięcie o jedną pozycję)
- Wywołanie menu do wprowadzania cyfr, znaków i znaków specjalnych
- Spacja
- Przejdź (potwierdzenie wprowadzonych danych)

Wprowadzanie znaków specjalnych

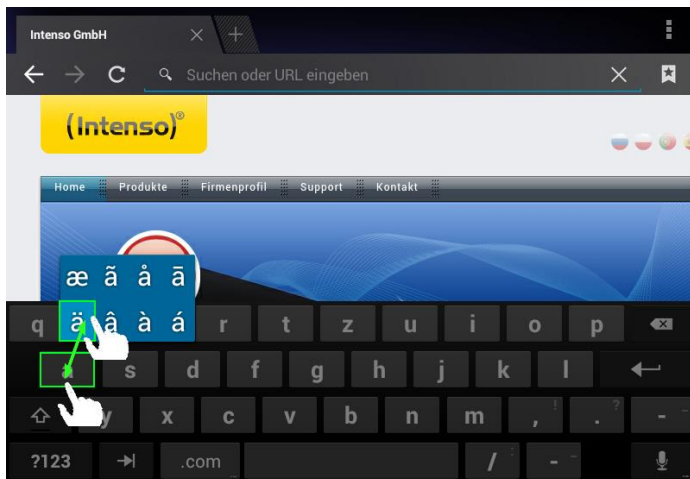
Aby wprowadzić **znak specjalny**, np. „ą”, należy **długo nacisnąć palcem** na klawisz „a”, aby wywołać **menu znaków specjalnych**. Następnie należy przesunąć palec na wybrany znak specjalny, na przykład „ą” i **zdzjąć palec** z wyświetlacza. Wprowadzona została litera „ą”.





Korzystanie z przeglądarki internetowej

- **Obraz wyświetlany na ekranie** można przewijać wykonując **palcami pionowy ruch przesunięcia**. Proszę **nie rozpoczynać** ruchu na **puncie menu** lub **linku**, gdyż otworzy się wtedy **odpowiednie łącze**.
- Aby otworzyć **link internetowy** należy po prostu nacisnąć na ten **link**. Nowa **strona** otworzy się **automatycznie**.
- Aby otworzyć **menu przeglądarki internetowej** należy nacisnąć **przycisk Menu** . Tutaj do dostępne są różne funkcje. Między innymi można tutaj **aktualizować otwartą stronę internetową**, **otworzyć nową kartę**, **zachować stronę do odczytu offline** albo przejść do **ustawień przeglądarki internetowej**.
- Aby **cofnąć się do poprzedniej strony**, należy nacisnąć **przycisk Wstecz** .
- Aby cofnąć się **bezpośrednio do ekranu startowego**, należy nacisnąć **przycisk Home** .
- Aby wprowadzić **tekst**, należy nacisnąć na **odpowiednie pole** i skorzystać z **wirtualnej klawiatury** do **wprowadzania tekstu**.

***Wskazówka:** Ta funkcja wymaga połączenia poprzez sieć bezprzewodową z Internetem.*

14.) Ustawienia systemowe

Naciskając w menu aplikacji na **ikonę ustawień**, wywołuje się **ustawienia systemowe**.

- Po **lewej stronie menu** znajdują się pojedyncze **kategorie**. **Krótkie naciśnięcie** wybranego **punktu menu** powoduje wyświetlenie **dostępnych możliwości ustawień**. Należy zwrócić uwagę, że ewentualnie nie wszystkie funkcje dostępne w systemie Android™ są kompatybilne z tym urządzeniem.
- Jeśli dokonano **wszystkich ustawień**, to za pomocą **przycisku wstecz**  można powrócić do **ostatniego wywołanego menu** lub **przyciskiem Home**  przejść bezpośrednio do **ekranu startowego**. **Dokonane zmiany** zostaną **automatycznie zapisane**.

Przegląd ustawień – najważniejsze ustawienia

Komunikacja bezprzewodowa i sieci	WiFi	Tutaj dokonuje się ustawień sieci bezprzewodowej.
	Więcej	Tutaj można dokonać dalszych ustawień sieciowych.
Urządzenie	Dźwięki	Ustawianie głośności i wybór dźwięku powiadomienia. Ponadto można aktywować wzgl. deaktywować dźwięk potwierdzenia dotknięcia ekranu dotykowego oraz dźwięk ostrzeżenia odblokowywania ekranu.
	Wyświetlacz	Jasność – regulacja jasności wyświetlacza. Tło – Wybór tła. Stan czuwania – Ustawianie opóźnienia automatycznego wyłączenia wyświetlacza. Wielkość czcionki – Ustawianie wybranej wielkości pisma.
	Pamięć	Tutaj można uzyskać informacje o wewnętrznej pamięci i – o ile zainstalowana – o karcie microSD. Ponadto można usunąć zawartość pamięci.
	Akumulator	Tutaj uzyskuje się informacje o stanie ładowania wbudowanego akumulatora.
	Aplikacje	Tutaj można zarządzać zainstalowanymi aplikacjami i otrzymać dalsze informacje o aplikacjach.
Użytkownik	Lokalizacja	Tutaj można zezwolić różnym aplikacją Android™, na ustalenie aktualnej lokalizacji w oparciu o sieci bezprzewodowe i korzystanie z tego (np. Google Maps™). Ponadto można ustawić, czy Google™ może dopasowywać do bieżącej lokalizacji wyniki wyszukiwania i inne usługi.
	Bezpieczeństwo	Tutaj można dokonać ustawień blokady ekranu oraz innych związanych z bezpieczeństwem funkcji.
	Język i wprowadzanie	Tutaj można na przykład ustawić preferowany język, dodawać do osobistego słownika różne wyrazy oraz dokonywać różnych ustawień klawiatury.
	Zabezpieczanie i zerowanie	Tutaj można zabezpieczyć na serwerach Google™ swoje ustawienia systemowe oraz dane aplikacji. Ponadto można powrócić do ustawień fabrycznych. <u>UWAGA</u> : W tym celu usuwane są wszystkie zapisane na urządzeniu dane.
Rachunki	Dodaj konto	Tutaj można dodać różne konta.
System	Data i czas	Tutaj można ustawić datę, czas, strefę czasową oraz format wyświetlania.
	O tablecie	Wyświetlane są informacje o urządzeniu.

15.) Zarządzanie aplikacjami

Aplikacje zainstalowane fabrycznie

Urządzenie to dostarczane jest z **zainstalowanymi fabrycznie aplikacjami**. **Przegląd** już zainstalowanych **aplikacji** znajduje się w **przeglądzie aplikacji**. Aby **otworzyć** te **aplikacje**, należy **krótko** nacisnąć na **odpowiednią ikonę**.

Instalacja aplikacji

- (1) Proszę otworzyć **wybrane źródło** z którego będą **pobierane aplikacje** (np. preinstalowany **Google Playstore™**). W tym celu należy najpierw zalogować się na swoje **istniejące konto Playstore™** lub utworzyć **nowe konto Playstore™**. W tym celu wystarczy postępować zgodnie ze **wskazówkami** pojawiającymi się na **ekranie**.
- (2) Po **udanym zalogowaniu** macie Państwo do dyspozycji **wiele aplikacji** znajdujących się w **Google Playstore™**. Proszę wybrać **żądaną aplikację**, kliknąć na **Installieren (Instaluj)** i ewentualnie wyrazić zgodę na **zezwoenie dostępu** przez aplikację. Teraz rozpoczyna się **pobieranie**, a w lewym, górnym rozszerzonym **pasku stanu** jest wyświetlany postęp procesu.
- (3) Po ukończeniu **pobierania** aplikacja **instaluje się** automatycznie. Po udanej instalacji nowa **aplikacja** będzie dostępna w **menu aplikacji**. Postęp procesu instalacji jest wyświetlany w lewym, górnym rozszerzonym **pasku stanu**.

Odinstalowywanie aplikacji





- (1) Należy otworzyć **Ustawienia systemu** naciskając krótko na **ikonę Ustawienia** w przeglądarce aplikacji.
- (2) Teraz należy krótko nacisnąć na punkt menu „Aplikacje”, aby przejść do **ustawień aplikacji**.
- (3) Krótkim **naciśnięciem** należy wybrać jeden z głównych punktów menu: **Pobieranie, Pamięć USB, Aktywna i Wszystkie**.
- (4) Przez **krótkie naciśnięcie** należy następnie wybrać **aplikację**, która ma zostać **odinstalowana**.
- (5) Należy teraz nacisnąć na „Odinstaluj” i potwierdzić wybór przyciskiem OK, aby odinstalować z urządzenia daną aplikację.

***Wskazówka:** Zainstalowanego fabrycznie oprogramowania nie można usunąć.*

16.) Eksplorator plików

Aby uruchomić **eksploratora plików**, należy otworzyć **przegląd aplikacji** i następnie krótko nacisnąć na **ikonę eksploratora**.

Nawigacja pomiędzy plikami i folderami

- Do wyboru istnieją **wewnętrzna pamięć** (internal Memory), **karta pamięci** (SD Card) i **USB**. Aby wyświetlić jako **listę zawarte na wybranym nośniku pliki**, należy nacisnąć na **wybrany nośnik**. Jeśli **nie** włożono **karty pamięci** lub **żadnego nośnika danych nie podłączono** do **portu USB**, pojawi się dla nich komunikat **„... is unmounted”**.
- Za pomocą **pionowego ruchu przesunięcia** można **przewijać** pliki i foldery. Za pomocą **krótkiego naciśnięcia** otwiera się **pliki i foldery**.
- Można **przejsć do przodu** –  lub **cofnąć się o krok**  krótko naciskając odpowiednią **ikonę**.
- Aby w **strukturze plików** przejść o **poziom wyżej**, należy **krótko** nacisnąć na **ikonę LevelUp** .
- Ikoną **Home**  przechodzi się **bezpośrednio** do **głównego folderu**.



Używanie paska narzędzi



Należy nacisnąć na **przycisk Menu**  i następnie na „Hide Toolbar”, aby ukryć wzgl. wyświetlić **pasek narzędzi**.

Home	Przejsć bezpośrednio do głównego folderu .
LevelUp	Przejsć o poziom wyżej .
Multi	Wybór kilku plików.
Editor	Kopiowanie, usuwanie, przenoszenie, wstawianie lub zmiana nazwy pliku lub folderu.
New Folder	Tworzenie nowego folderu.
Back	Krok w tył.
Next	Krok w przód.

Kopiowanie, przenoszenie i zmiana nazwy pliku i folderu

- 1.) Najpierw należy **przejsć** do **wybranego pliku** w **podglądzie plików**.
- 2.) Należy nacisnąć i **przytrzymać** palec na **pliku**, aż wyświetli się **pole informacyjne**.
- 3.) Teraz należy wybrać **funkcję**. Do wyboru są **kopiowanie** (Copy), **usuwanie** (Delete), **przenoszenie** (Move), **wstawianie** (Paste) – w tym celu plik musi znajdować się w **schowku** – oraz **zmiana nazwy** (Rename).
- 4.) Aby **skopiować** lub **przenieść**, należy krótko nacisnąć na **odpowiednią ikonę** (Copy / Move) i następnie **przejsć** do **folderu docelowego**. Następnie należy nacisnąć na **ikonę edytora**  i wybrać przez **krótkie naciśnięcie** „Paste”, aby **wkleić plik**.
- 5.) Aby **usunąć plik** należy nacisnąć na „Delete” i **potwierdzić zabezpieczenie** przez ponowne naciśnięcie „Delete”. Aby **anulować** należy **krótko** nacisnąć na „Cancel”.
- 6.) Aby **zmienić nazwę pliku**, należy nacisnąć na „Rename” i **następnie** wpisać używając **wirtualnej klawiatury nową nazwę pliku**. Wprowadzoną nazwę należy **potwierdzić** naciskając „OK” lub anulować **proces** naciskając „Cancel”.
- 7.) Można **jednocześnie kopiować, usuwać** lub **przenosić kilka plików i folderów**. W tym celu należy nacisnąć **ikonę Multi**  i **następnie** nacisnąć na **wybrane pliki**. **Zaznaczone pliki** zostaną teraz wyświetlone w **innym kolorze**. Naciskając na **ikonę Editor**  można przeprowadzić wybrane działanie.

17.) Warunki ograniczonej gwarancji

Gwarancja obejmuje wyłącznie wymianę niniejszego produktu firmy Intenso. Gwarancja nie obejmuje normalnych objawów zużycia, które są wynikiem niewłaściwego, nieprawidłowego użytkownika, niestaranności, wypadku, niekompatybilności lub jest wynikiem niewystarczającej wydajności konkretnego sprzętu lub oprogramowania komputerowego.

Roszczenia gwarancyjne nie obejmują przypadków wynikających z niestosowania się do Instrukcji obsługi firmy Intenso oraz nieprawidłowego montażu, użytkownika lub uszkodzenia spowodowanego przez inne urządzenie.

Jeśli produkt poddany został wstrząsom, wylądowaniom elektrycznym, temperaturze i wilgotności spoza zakresu specyfikacji produktu, to brak jest podstaw do roszczeń gwarancyjnych.

Firma Intenso nie odpowiada za utratę danych lub jakiegokolwiek szkody towarzyszące lub następstwa, za przekroczenie warunków gwarancji lub inne szkody bez względu na ich powód.

Produkt ten nie jest przeznaczony do wykorzystania komercyjnego lub zastosowań medycznych i specjalnych, w przypadku których awaria produktu może spowodować zranienia, śmierć lub znaczne szkody materialne.

18.) Dane techniczne

CPU	1.0 GHz Dualcore based on Cortex A9
Pamięć operacyjna	1 GB DDR 3
System operacyjny	Android 4.2.2
Kompatybilne systemy operacyjne	Windows XP / Vista / 7 / 8 / Linux 2,4 lub nowszy / Mac 10.6 lub nowszy
Możliwości podłączeń	Słuchawki, micro SD (SDHC/SDXC), micro USB
Sieć bezprzewodowa	WiFi (802.11 b/g/n)
Czujnik przeciążenia	obrót 360 stopni
Format zdjęć	JPEG, BMP, GIF, PNG
Format audio	MP3, WMA, WAV, OGG, FLAC, APE
Format wideo	MPEG1, MPEG 4, FLV
Wyświetlacz	wyświetlacz TFT LCD, 1024 x 600 pikseli
Kamera	przednia kamera 0,3 MP
SNR	>= 80 dB
Zakres częstotliwości	20 Hz – 20 KHz
Zasilacz	(V) AC Adapter (HUONIO HNBC050120UE): AC Input 100-240V~50/60Hz, DC Output 5V / 1.2A
Akumulator wewnętrzny	akumulator litowo-polimerowy

19.) Konserwacja urządzenia

Nie wolno przyska lub nanosić płynu bezpośrednio na wyświetlacz lub obudowę.

20.) Czyszczenie urządzenia

Obudowę, ramkę i wyświetlacz ostrożnie przetrzeć miękką, niekłaczącą i wolną od substancji chemicznych szmatką. Używać wyłącznie środków czyszczących przeznaczonych specjalnie dla wyświetlaczy.

21.) Utylizacja zużytych urządzeń elektrycznych

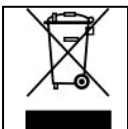

Urządzenia oznaczone tym symbolem podlegają europejskiej dyrektywie 2002/96/WE.

Wszystkie urządzenia elektryczne i elektroniczne muszą być utylizowane niezależnie od odpadów komunalnych, przez wyznaczone do tego instytucje.

Poprzez prawidłową utylizację zużytych urządzeń elektronicznych zapobiega się skażeniu środowiska naturalnego.

(Intenso)[®]

49377 Vechta
Germany
www.intenso.de



22.) Licencja informacja

Notice of GNU GENERAL PUBLIC LICENSE and LESSER GENERAL PUBLIC LICENCE

Dear Customer,

If interested, you and any third party can download the source code of used GPL / LGPL from Intenso Webpage <http://www.intenso.de>. The source code of the desired product is available to anyone on the selection of valid product category and the desired device. In the product details you will find the entry "drivers". Open this menu to download the corresponding GPL / LGPL code. For a fee of 35 € (delivery to another country as Germany), it is also possible to obtain this code by postal delivery. More information about the GPL/LGPL-Licence can you find on following website www.gnu.org

GNU GENERAL PUBLIC LICENSE

Version 2, June 1991

Copyright (C) 1989, 1991 Free Software Foundation, Inc.

51 Franklin Street, Fifth Floor, Boston, MA 02110-1301, USA

Everyone is permitted to copy and distribute verbatim copies of this license document, but changing it is not allowed.

Preamble

The licenses for most software are designed to take away your freedom to share and change it. By contrast, the GNU General Public License is intended to guarantee your freedom to share and change free software--to make sure the software is free for all its users. This General Public License applies to most of the Free Software Foundation's software and to any other program whose authors commit to using it. (Some other Free Software Foundation software is covered by the GNU Lesser General Public License instead.) You can apply it to your programs, too.

When we speak of free software, we are referring to freedom, not price. Our General Public Licenses are designed to make sure that you have the freedom to distribute copies of free software (and charge for this service if you wish), that you receive source code or can get it if you want it, that you can change the software or use pieces of it in new free programs; and that you know you can do these things.

To protect your rights, we need to make restrictions that forbid anyone to deny you these rights or to ask you to surrender the rights. These restrictions translate to certain responsibilities for you if you distribute copies of the software, or if you modify it.

For example, if you distribute copies of such a program, whether gratis or for a fee, you must give the recipients all the rights that you have. You must make sure that they, too, receive or can get the source code. And you must show them these terms so they know their rights.

We protect your rights with two steps: (1) copyright the software, and (2) offer you this license which gives you legal permission to copy, distribute and/or modify the software.

Also, for each author's protection and ours, we want to make certain that everyone understands that there is no warranty for this free software. If the software is modified by someone else and passed on, we want its recipients to know that what they have is not the original, so that any problems introduced by others will not reflect on the original authors' reputations.

Finally, any free program is threatened constantly by software patents. We wish to avoid the danger that redistributors of a free program will individually obtain patent licenses, in effect making the program proprietary. To prevent this, we have made it clear that any patent must be licensed for everyone's free use or not licensed at all.

The precise terms and conditions for copying, distribution and modification follow.

TERMS AND CONDITIONS FOR COPYING, DISTRIBUTION AND MODIFICATION

0. This License applies to any program or other work which contains a notice placed by the copyright holder saying it may be distributed under the terms of this General Public License. The "Program", below, refers to any such program or work, and a "work based on the Program" means either the Program or any derivative work under copyright law: that is to say, a work containing the Program or a portion of it, either verbatim or with modifications and/or translated into another language. (Hereinafter, translation is included without limitation in the term "modification".) Each licensee is addressed as "you".

Activities other than copying, distribution and modification are not covered by this License; they are outside its scope. The act of running the Program is not restricted, and the output from the Program is covered only if its contents constitute a work based on the Program (independent of having been made by running the Program). Whether that is true depends on what the Program does.

1. You may copy and distribute verbatim copies of the Program's source code as you receive it, in any

medium, provided that you conspicuously and appropriately publish on each copy an appropriate copyright notice and disclaimer of warranty; keep intact all the notices that refer to this License and to the absence of any warranty; and give any other recipients of the Program a copy of this License along with the Program. You may charge a fee for the physical act of transferring a copy, and you may at your option offer warranty protection in exchange for a fee.

2. You may modify your copy or copies of the Program or any portion of it, thus forming a work based on the Program, and copy and distribute such modifications or work under the terms of Section 1 above, provided that you also meet all of these conditions:

- a) You must cause the modified files to carry prominent notices stating that you changed the files and the date of any change.
 - b) You must cause any work that you distribute or publish, that in whole or in part contains or is derived from the Program or any part thereof, to be licensed as a whole at no charge to all third parties under the terms of this License.
 - c) If the modified program normally reads commands interactively when run, you must cause it, when started running for such interactive use in the most ordinary way, to print or display an announcement including an appropriate copyright notice and a notice that there is no warranty (or else, saying that you provide a warranty) and that users may redistribute the program under these conditions, and telling the user how to view a copy of this License. (Exception: if the Program itself is interactive but does not normally print such an announcement, your work based on the Program is not required to print an announcement.)
- These requirements apply to the modified work as a whole. If identifiable sections of that work are not derived from the Program, and can be reasonably considered independent and separate works in themselves, then this License, and its terms, do not apply to those sections when you distribute them as separate works. But when you distribute the same sections as part of a whole which is a work based on the Program, the distribution of the whole must be on the terms of this License, whose permissions for other licensees extend to the entire whole, and thus to each and every part regardless of who wrote it. Thus, it is not the intent of this section to claim rights or contest your rights to work written entirely by you; rather, the intent is to exercise the right to control the distribution of derivative or collective works based on the Program.

In addition, mere aggregation of another work not based on the Program with the Program (or with a work based on the Program) on a volume of a storage or distribution medium does not bring the other work under the scope of this License.

3. You may copy and distribute the Program (or a work based on it, under Section 2) in object code or executable form under the terms of Sections 1 and 2 above provided that you also do one of the following:

- a) Accompany it with the complete corresponding machine-readable source code, which must be distributed under the terms of Sections 1 and 2 above on a medium customarily used for software interchange; or,
- b) Accompany it with a written offer, valid for at least three years, to give any third party, for a charge no more than your cost of physically performing source distribution, a complete machine-readable copy of the corresponding source code, to be distributed under the terms of Sections 1 and 2 above on a medium customarily used for software interchange; or,
- c) Accompany it with the information you received as to the offer to distribute corresponding source code. (This alternative is allowed only for noncommercial distribution and only if you received the program in object code or executable form with such an offer, in accord with Subsection b above.)

The source code for a work means the preferred form of the work for making modifications to it. For an executable work, complete source code means all the source code for all modules it contains, plus any associated interface definition files, plus the scripts used to control compilation and installation of the executable. However, as a special exception, the source code distributed need not include anything that is normally distributed (in either source or binary form) with the major components (compiler, kernel, and so on) of the operating system on which the executable runs, unless that component itself accompanies the executable.

If distribution of executable or object code is made by offering access to copy from a designated place, then offering equivalent access to copy the source code from the same place counts as distribution of the source code, even though third parties are not compelled to copy the source along with the object code.

4. You may not copy, modify, sublicense, or distribute the Program except as expressly provided under this License. Any attempt otherwise to copy, modify, sublicense or distribute the Program is void, and will automatically terminate your rights under this License. However, parties who have received copies, or rights, from you under this License will not have their licenses terminated so long as such parties remain in full compliance.

5. You are not required to accept this License, since you have not signed it. However, nothing else grants you permission to modify or distribute the Program or its derivative works. These actions are prohibited by

law if you do not accept this License. Therefore, by modifying or distributing the Program (or any work based on the Program), you indicate your acceptance of this License to do so, and all its terms and conditions for copying, distributing or modifying the Program or works based on it.

6. Each time you redistribute the Program (or any work based on the Program), the recipient automatically receives a license from the original licensor to copy, distribute or modify the Program subject to these terms and conditions. You may not impose any further restrictions on the recipients' exercise of the rights granted herein. You are not responsible for enforcing compliance by third parties to this License.

7. If, as a consequence of a court judgment or allegation of patent infringement or for any other reason (not limited to patent issues), conditions are imposed on you (whether by court order, agreement or otherwise) that contradict the conditions of this License, they do not excuse you from the conditions of this License. If you cannot distribute so as to satisfy simultaneously your obligations under this License and any other pertinent obligations, then as a consequence you may not distribute the Program at all. For example, if a patent license would not permit royalty-free redistribution of the Program by all those who receive copies directly or indirectly through you, then the only way you could satisfy both it and this License would be to refrain entirely from distribution of the Program.

If any portion of this section is held invalid or unenforceable under any particular circumstance, the balance of the section is intended to apply and the section as a whole is intended to apply in other circumstances. It is not the purpose of this section to induce you to infringe any patents or other property right claims or to contest validity of any such claims; this section has the sole purpose of protecting the integrity of the free software distribution system, which is implemented by public license practices. Many people have made generous contributions to the wide range of software distributed through that system in reliance on consistent application of that system; it is up to the author/donor to decide if he or she is willing to distribute software through any other system and a licensee cannot impose that choice. This section is intended to make thoroughly clear what is believed to be a consequence of the rest of this License.

8. If the distribution and/or use of the Program is restricted in certain countries either by patents or by copyrighted interfaces, the original copyright holder who places the Program under this License may add an explicit geographical distribution limitation excluding those countries, so that distribution is permitted only in or among countries not thus excluded. In such case, this License incorporates the limitation as if written in the body of this License.

9. The Free Software Foundation may publish revised and/or new versions of the General Public License from time to time. Such new versions will be similar in spirit to the present version, but may differ in detail to address new problems or concerns.

Each version is given a distinguishing version number. If the Program specifies a version number of this License which applies to it and "any later version", you have the option of following the terms and conditions either of that version or of any later version published by the Free Software Foundation. If the Program does not specify a version number of this License, you may choose any version ever published by the Free Software Foundation.

10. If you wish to incorporate parts of the Program into other free programs whose distribution conditions are different, write to the author to ask for permission. For software which is copyrighted by the Free Software Foundation, write to the Free Software Foundation; we sometimes make exceptions for this. Our decision will be guided by the two goals of preserving the free status of all derivatives of our free software and of promoting the sharing and reuse of software generally.

NO WARRANTY

11. BECAUSE THE PROGRAM IS LICENSED FREE OF CHARGE, THERE IS NO WARRANTY FOR THE PROGRAM, TO THE EXTENT PERMITTED BY APPLICABLE LAW. EXCEPT WHEN OTHERWISE STATED IN WRITING THE COPYRIGHT HOLDERS AND/OR OTHER PARTIES PROVIDE THE PROGRAM "AS IS" WITHOUT WARRANTY OF ANY KIND, EITHER EXPRESSED OR IMPLIED, INCLUDING, BUT NOT LIMITED TO, THE IMPLIED WARRANTIES OF MERCHANTABILITY AND FITNESS FOR A PARTICULAR PURPOSE. THE ENTIRE RISK AS TO THE QUALITY AND PERFORMANCE OF THE PROGRAM IS WITH YOU. SHOULD THE PROGRAM PROVE DEFECTIVE, YOU ASSUME THE COST OF ALL NECESSARY SERVICING, REPAIR OR CORRECTION.

12. IN NO EVENT UNLESS REQUIRED BY APPLICABLE LAW OR AGREED TO IN WRITING WILL ANY COPYRIGHT HOLDER, OR ANY OTHER PARTY WHO MAY MODIFY AND/OR REDISTRIBUTE THE PROGRAM AS PERMITTED ABOVE, BE LIABLE TO YOU FOR DAMAGES, INCLUDING ANY GENERAL, SPECIAL, INCIDENTAL OR CONSEQUENTIAL DAMAGES ARISING OUT OF THE USE OR INABILITY TO USE THE PROGRAM (INCLUDING BUT NOT LIMITED TO LOSS OF DATA OR DATA BEING RENDERED INACCURATE OR LOSSES SUSTAINED BY YOU OR THIRD PARTIES OR A FAILURE OF THE PROGRAM TO OPERATE WITH ANY OTHER PROGRAMS), EVEN IF SUCH HOLDER OR OTHER

PARTY HAS BEEN ADVISED OF THE POSSIBILITY OF SUCH DAMAGES.

END OF TERMS AND CONDITIONS

How to Apply These Terms to Your New Programs

If you develop a new program, and you want it to be of the greatest possible use to the public, the best way to achieve this is to make it free software which everyone can redistribute and change under these terms.

To do so, attach the following notices to the program. It is safest to attach them to the start of each source file to most effectively convey the exclusion of warranty; and each file should have at least the "copyright" line and a pointer to where the full notice is found.

one line to give the program's name and an idea of what it does.

Copyright (C) yyyy name of author

This program is free software; you can redistribute it and/or modify it under the terms of the GNU General Public License as published by the Free Software Foundation; either version 2 of the License, or (at your option) any later version.

This program is distributed in the hope that it will be useful, but WITHOUT ANY WARRANTY; without even the implied warranty of MERCHANTABILITY or FITNESS FOR A PARTICULAR PURPOSE. See the GNU General Public License for more details.

You should have received a copy of the GNU General Public License along with this program; if not, write to the Free Software

Foundation, Inc., 51 Franklin Street, Fifth Floor, Boston, MA 02110-1301, USA.

Also add information on how to contact you by electronic and paper mail.

If the program is interactive, make it output a short notice like this when it starts in an interactive mode:

Gnomovision version 69, Copyright (C) year name of author

Gnomovision comes with ABSOLUTELY NO WARRANTY; for details

type `show w'. This is free software, and you are welcome

to redistribute it under certain conditions; type `show c'

for details.

The hypothetical commands `show w' and `show c' should show the appropriate parts of the General Public License. Of course, the commands you use may be called something other than `show w' and `show c'; they could even be mouse-clicks or menu items--whatever suits your program.

You should also get your employer (if you work as a programmer) or your school, if any, to sign a "copyright disclaimer" for the program, if necessary. Here is a sample; alter the names:

Yoyodyne, Inc., hereby disclaims all copyright

interest in the program `Gnomovision'

(which makes passes at compilers) written

by James Hacker.

signature of Ty Coon, 1 April 1989

Ty Coon, President of Vice

Deklaracja zgodności UE

My, Intenso GmbH,
z siedzibą Diepholzer Str. 15 w 49377 Vechta, Niemcy

deklarujemy na władną odpowiedzialność, że produkt:

Model: 7" TAB 734 (artykuł nr 5509854)

Opis: komputer typu tablet

jest zgodny z następującymi dyrektywami i normami:

Dyrektywa R&TTE 1999/5/WE

- EN 301 489-1 V1.9.2
- EN 301 489-17 V2.1.1
- EN 300 328 V1.7.1 : 2006-10
- EN 55022:2010 (Class B)
- EN 55024:2010
- EN 61000-3-2:2006+A1 :2009+A2 :2009 (Class D)
- EN 61000-3-3:2008

Dyrektywa niskonapięciowa 2006/95/WE

- EN 60950-1:2006+A11:2009+A1:2010+A12:2011+A12:korekta 2012

Dyrektywa w sprawie ekoprojektu 2009/125/EG

- 1275/2008
- 278/2009

Dyrektywa ROHS 2011/65/EU

Dokumentacja techniczna dotycząca wyżej wymienionego urządzenia została złożona w następującym miejscu:

Intenso GmbH
Diepholzer Str. 15, 49377 Vechta, Niemcy

Osoba upoważniona:

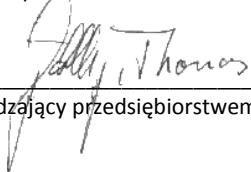

Zarządzający przedsiębiorstwem: Thomas Pöhlking

Руководство пользователя TAB 734

Мы благодарим Вас за то, что Вы выбрали **TAB 734**. Внимательно прочтите это руководство, чтобы узнать о важнейших функциях устройства.



1.) Содержание

1.) Содержание.....	1
2.) Советы.....	2
3.) Обзор устройства.....	4
4.) Содержание упаковки.....	4
5.) Зарядка аккумулятора.....	5
6.) Использование карты MICRO SD/SDHC/SDXC.....	5
7.) Перенос данных между устройством и компьютером.....	5
8.) Сенсорный экран.....	6
9.) WIFI.....	6
Автоматическое соединение.....	6
Установка соединения вручную.....	7
10.) Пусковой экран.....	8
Вид.....	8
Разблокирование экрана.....	8
Строка состояния.....	9
Настройка вида стартового экрана.....	10
Использование разных пусковых экранов.....	10
Предустановленные приложения на пусковом экране.....	11
11.) Обзор приложений.....	11
12.) Отправка / прием электронных писем.....	12
Настройка вашего почтового ящика.....	12
Управление учетными записями электронной почты.....	13
Для введения необходимых сведений нажмите на «Настройки учетной записи», которые необходимо изменить.....	13
Отображение новостей E-Mail.....	13
Написание электронных писем.....	13
13.) Интернет браузер.....	14
Использование виртуальной клавиатуры.....	14
Ввод специальных знаков.....	14
Использование интернет браузера.....	15
14.) Системные настройки.....	15
Обзор настроек.....	16
15.) Управление приложениями.....	17
Установка приложений разного назначения.....	17
Удаление приложений.....	17
16.) Обзорщик файлов.....	18
Навигация сквозь данные и папки.....	18
Использовать инструментальную панель.....	18
Копировать, перемещать и переименовывать данные.....	18
17.) Ограничение гарантийного срока.....	19
18.) Технические данные.....	19
19.) Обслуживание устройства.....	20
20.) Очистка устройства.....	20
21.) Утилизация электрического оборудования.....	20
22.) лицензия информация.....	21
ЕС Заявление о соответствии товара.....	25

Данное устройство не может содержать все особенности вашего устройства. Для использования приложений от сторонних и третьих компаний, пожалуйста, свяжитесь с производителем. Обратите внимание, что все детали могут быть изменены. Актуальную информацию можно найти на сайте www.intenso.de

Торговый знак

Google™, логотип Google™ и Android™ являются торговыми марками Google Inc.: Все остальные названия продуктов и сервисов являются собственностью соответствующих владельцев.

2.) Советы

- Избегайте сильного удара или падения устройства. Не кладите устройства на наклонные поверхности, дабы избежать падение устройства.
- Не используйте устройство в экстремально холодных, жарких, влажных или пыльных регионах или местах. Избегайте попадание на устройство прямых солнечных лучей.
- Не используйте устройство в песочных местах.
- Не используйте устройство в взрывоопасном окружении, например вблизи около бензоколонок на заправках
- Не используйте устройство на подушках, диванах или других предметах, которые поддерживают нагрев устройства. Есть опасность перегрева устройства.
- Проводите чаще резервные копии данных для обеспечения сохранения ваших файлов. Мы не отвечаем за потерю ваших данных.
- Не отсоединяйте и не прерывайте контакт или связь при переносе данных или когда осуществляется форматирование устройства. Это может привести к потере данных.
- Фильмы и картинки могут быть защищены от просмотра третьими лицами. Просмотр без лицензии нарушает право собственности владельца.
- Избегайте использование в сильно намагниченных полях.
- Берегите устройство от влаги. При попадании в устройство влажности, немедленно прочистите устройство и просушите устройство.
- Не используйте химические растворы для очистки устройства. Используйте только сухую салфетку.
- Не устанавливайте вблизи устройства предметы с открытым огнем, такие как например горящие свечи.
- Мы не отвечаем за причиненные дефекты при ошибочном использовании, потерю данных, самостоятельного ремонта устройства или замены аккумулятора.
- В случае, если устройство не реагирует на ваши действия или ввод данных, используйте кнопку перезагрузки на обратной стороне устройства.
- Когда вы не используете устройство, отсоедините его от сети высокого напряжения.
- Следите за тем, чтобы розетка находилась вблизи устройства для быстрого и легкого доступа к ней.
- Эксплуатируйте сетевой адаптер только с заземленными розетками с AC 100-240В~, 50/60 Гц. Если вы не уверены в обеспечении качества проводимого напряжения, обратитесь к вашему поставщику электроэнергии.
- Используйте только оригинальный сетевой адаптер и сетевой кабель для подключения.
- Для прекращения подачи электроэнергии к вашему устройству вытяните сетевой кабель из розетки. При извлечении касайтесь всегда только сетевой части. Никогда не тяните за непосредственный кабель.

- Открывать корпус сетевого адаптера запрещено. При открытом сетевом адаптере угрожает опасность смерти. В нем не содержится никаких вспомогательных или обслуживающих деталей.
- При долгом не использовании устройства аккумулятор медленно разряжается. Перед использованием необходимо зарядить заново аккумулятор
- Соблюдайте пожалуйста, экологический безопасный и приемлемый способ утилизации устройства и аккумулятора.
- Не пытайтесь разложить или разобрать устройство на отдельные части, и не пытайтесь его самостоятельно чинить. Это нарушает и погашает действительный гарантийный срок.
- Не используйте устройство в местах, где запрещено использовать мобильные устройства. Не используйте устройства вблизи других электронных устройств, т.к. это способно привести к ошибкам по причине высокочастотных сигналов.
- Не используйте устройство по счету шагов в больнице или вблизи медицинских приборов, т.к. по причине высокочастотных сигналов могут возникать ошибки других аппаратов. Держите устройство как минимум на расстоянии в 15см к другим устройствам. Обратитесь к производителю этих аппаратов для получения более подробной информации и совместного использования.
- Korzystanie ze słuchawek nosznych lub dousznych przy zbyt dużej głośności może doprowadzić do stałego uszkodzenia organów słuchu. Prosimy zwrócić uwagę, że długotrwałe oddziaływanie wysokiej głośności może prowadzić do trwałego uszkodzenia słuchu. Aby uniknąć możliwego ryzyka zdrowotnego spowodowanego przez wysoką głośność, zalecamy używanie wyłącznie zawartych w zestawie słuchawek.
- По правилам дорожно-транспортных перевозок запрещается использовать устройство во время управления транспортным средством.

3.) Обзор устройства

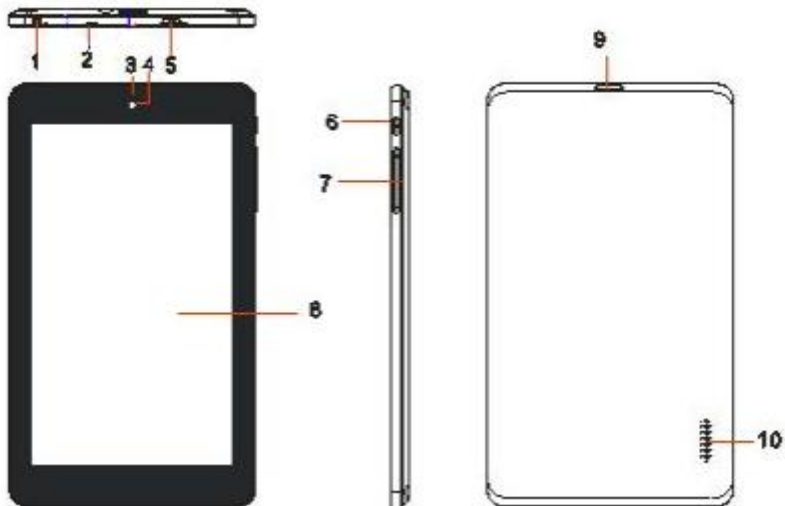

- (1) Разъем для наушников 3.5mm
- (2) Встроенный микрофон
- (3) Индикатор заряда батареи:
красный - во время зарядки;
желтый – когда батарея полностью
заряжена.
- (4) Передняя камера
- (5) Разъем Micro USB

- (6) Кнопка Вкл / Выкл: Держать
нажатой для выключения
устройства; быстрое нажатие
приводит к переключению
режимов из активного в режим
ожидания
- (7) Громкость + / -
- (8) Сенсорный экран
- (9) Разъем для карт памяти Micro
SD
- (10) Встроенные громкоговорители

4.) Содержание упаковки

Проверьте обязательно **полноценность** содержания и устройств в **упаковке**:

- TAB 734
- Наушники Stereo
- USB кабель
- Сетевой адаптер 5В 1.2А
- Инструкция по эксплуатации

5.) Зарядка аккумулятора

Полностью зарядите аккумуляторную батарею устройства **перед** первым использованием. Для этого **соедините сетевой блок питания**, входящий в комплект поставки, с устройством, и вставьте его в розетку. **Полная зарядка** аккумулятора занимает примерно **5 часов**. Индикатор зарядки расположен в **передней левой части** корпуса устройства. **Во время зарядки светодиодный индикатор** горит **красным** цветом, а при полной зарядке аккумулятора - **желтым**.

Внимание:

- a. Вы получите предупреждающий сигнал и сообщение при состоянии заряда аккумулятора в 15. Вам необходимо для зарядки вашего устройства соединить его с помощью сетевого адаптера с розеткой. Таким образом вы предотвратите потерю данных и сохраните срок службы вашего аккумулятора.
 - b. Вы можете пользоваться устройством во время его зарядки. Для обеспечения долгого срока службы батареи мы просим вас во время зарядки устройством не пользоваться.
 - c. Для достижения хороших показателей, встроенным аккумулятором необходимо пользоваться достаточно часто. В случае, если вы редко используете устройство, то заряжайте хотя бы один раз в месяц полностью аккумулятор.
 - d. Будьте уверены в использовании только оригинального сетевого адаптера, который входит в комплект поставки продукта.
-

6.) Использование карты MICRO SD/SDHC/SDXC

Данное устройство может считывать данные **непосредственно** с карты памяти «**Micro SD/SDHC/SDXC**», с **максимальной вместимостью – 64 Гбайта**. Чтобы воспользоваться картой памяти «**Micro SD/SDHC/SDXC**», вставьте ее в соответствующий слот «**Micro SD Slot**» с **левой стороны устройства**. Чтобы получить доступ к **данным**, имеющимся на данной **карте памяти**, воспользуйтесь **заранее установленной программой «Проводник» (Explorer)**, при этом откройте в данной программе каталог с **названием «SD Card»**.

7.) Перенос данных между устройством и компьютером.

- 1.) Соедините устройство с помощью предоставленного кабеля **USB** с компьютером.
- 2.) На экране высвечивается теперь знак соединения с **кабелем USB**. Нажмите быстро на «активировать **память USB**». Идет распознавание устройства как **носителя данных** и информации и вы получите информацию «**память USB активна**». При **быстром** нажатии на кнопку **Home** вы можете дальше пользоваться вашим устройством. Теперь у вас есть **доступ** с **компьютера** на внутреннюю память вашего **устройства** и возможность **копировать, удалять** или **перемещать** любую хранящуюся на устройстве **информацию**.
- 3.) При установленном USB-соединении с компьютером в строке состояния будет активирован значок USB. В расширенной строке состояния предоставляется дополнительная информация и здесь же можно активировать или деактивировать USB-соединение.
 - Для **деактивации** накопителя следует выбрать «**Деактивировать USB-накопитель**».
 - Для отключения устройства выберите на компьютере **функцию «Безопасное извлечение»** .

Внимание: Установленная на системе устройства операционная система **Android™** занимает часть внутренней памяти устройства – примерно 1 Гб. По этой причине вам доступен не весь размер внутренней памяти.

8.) Сенсорный экран



Это устройство управляется при помощи **сенсорного экрана**. Приложение запускается легким нажатием на экран. Также сенсорный экран позволяет вводить тексты на виртуальной клавиатуре и, пролистывая в соответствующем направлении, переходить от одного стартового экрана к другому.

Удалите, пожалуйста, защитную пленку с экрана перед началом использования устройства.

Сенсорный экран распознает и реагирует на малейшие **электрические разряды**, как например в пальцах человека, и служит этим пунктом ввода информации. Используйте в **идеальном варианте** для ввода информации ваши **кончики пальцев**. **Запрещено** эксплуатировать устройство с помощью ручки, карандаша или других **заостренных** предметов.

Не допускайте попадание **воды** в устройство или контактное сопряжение с другими **электрическими приборами**. Это может вызывать ошибки и **фатальные дефекты**.

Внимание:

- a. Если вы более двух минут не задействуете сенсорный экран, он меняет режим на энергосберегающий модус ожидания. Нажмите кнопку **ВКЛ/ВЫКЛ** для включения активного режима.
 - b. Для безопасного предотвращения случайного нажатия и ввода информации автоматический включается и активируется блокировка кнопок. Разблокируйте защиту кнопок на сенсорном экране. Прикоснитесь к символу «закрытый замок»  на дисплее и удерживайте его. Перетяните «замок», пока он не «откроется» , а затем отпустите палец. Экран разблокируется.
-

Поворачивая устройство в любую сторону, аппарат **автоматический выстраивается** по вашему положению просмотра и наклона. Это возможно благодаря **специального сенсора**, встроенного в устройство.

9.) WIFI

Для выхода в **Интернет** используйте **соединение WIFI**. Для установки соединения используйте **иконку WIFI** в **стартовом окне**, или выберите пункт **Настройки WIFI** в меню **Настройки**.

Внимание: Соблюдайте расстояние сети **WLAN** и вашего устройства для обеспечения соединения в актуальной позиции

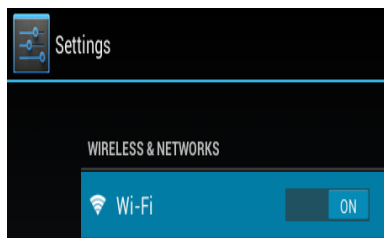

Автоматическое соединение

Откройте настройки **WLAN** в меню настроек. Здесь Вы можете **активировать** или **деактивировать функцию WLAN**. Просто уберите **виртуальный коммутатор** с позиции «Включено» слева, чтобы **отключить** функцию WLAN. Теперь на дисплее появится **сообщение «Выключено»**. Для **повторной активации** или **деактивации функции WLAN** перенесите **виртуальный коммутатор** на правую сторону.

В **Настройках WIFI** в правой колонке приведен список **доступных сетей**, а также **всех используемых сетей**.

Выберите желаемую вами сеть и введите по требованию для желаемой сети подходящий пароль для установления соединения.

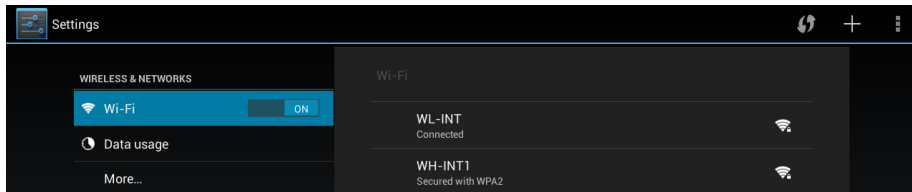

Для **подтверждения** введенного пароля нажмите на кнопку **Enter**, а затем на кнопку **Установить соединение**. Через **некоторое время** будет **установлено соединение**.

Внимание:

- a) Если ваше устройство переходит в режим ожидания, тогда соединение WLAN автоматический деактивируется. Это обеспечивает экономию потребления электроэнергии и сохраняет заряд вашего аккумулятора. Когда возвращаетесь в активный режим, соединение автоматический восстанавливается. Это занимает несколько секунд.
 - b) Список актуально найденных сетей WLAN обновляется автоматический.
 - c) Когда функция WLAN активна, устройство соединяется автоматический с настроенной сетью при попадании в поле раздачи сигнала.
 - d) При попадании в поле неизвестной сети WLAN, на экран выводится информационное поле и соединении.
-

Установка соединения вручную

Для **поиска доступного** беспроводного соединения по локальной сети выполните следующие действия:



- (1) Откройте **Настройки**.
- (2) Теперь откройте **настройки WLAN** и выберите три пункта в правом верхнем углу, затем нажмите **«сканирование»**.
- (3) Если беспроводная локальная сеть не появилась в списке сетей, находящихся в зоне доступа, выберите пункт **«Добавить сеть»**, чтобы вручную ввести сеть SSID, протокол безопасности и, если необходимо, соответствующий пароль. Для подтверждения ввода данных нажмите на **«Сохранить»**.

10.) Пусковой экран

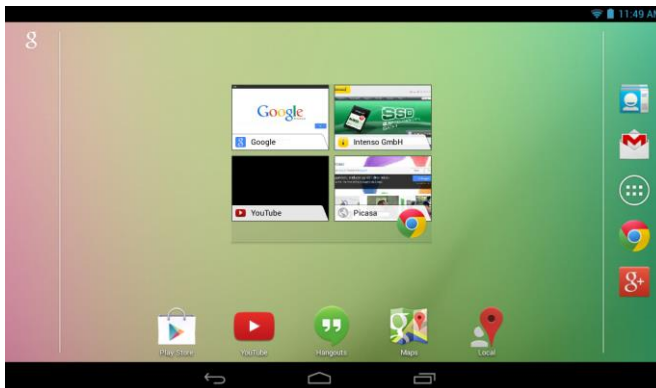
Вид



Разблокирование экрана

Если сенсорный экран **не используется в течение двух минут**, устройство переходит в **режим ожидания**. Нажмите на кнопку **вкл. / выкл.**, не удерживая ее, и устройство перейдет в **рабочий режим**. Дисплей защищен от **непреднамеренного ввода данных**. Прикоснитесь к символу «закрытый замок»  на дисплее и **удерживайте его**. **Перетяните «замок»**, пока он не «откроется» , а затем **отпустите палец**. Экран **разблокируется**.

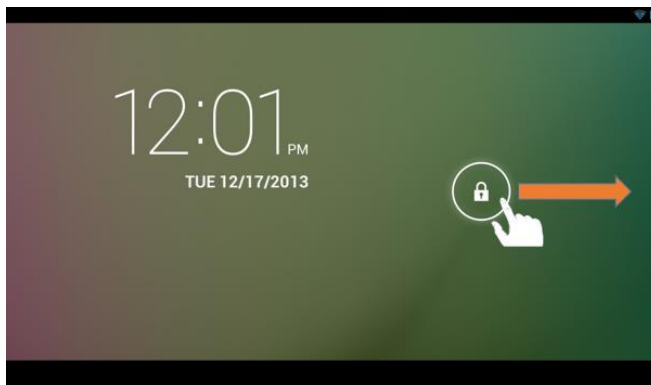

Протяните символ в помощь вашего пальца в сторону направляющей полосы

Примечание: перетяните **символ «замок»** к появляющемуся на экране **символу «камера»**. Теперь вы можете **непосредственно использовать камеру**.

Строка состояния

Строки состояния расположены в **верхней и нижней** части экрана запуска.

Верхняя строка состояния разделена на **две области**. Если Вы опустите строку состояния на **левую сторону**, отобразится **текущее сообщение**, если таковое имеется.

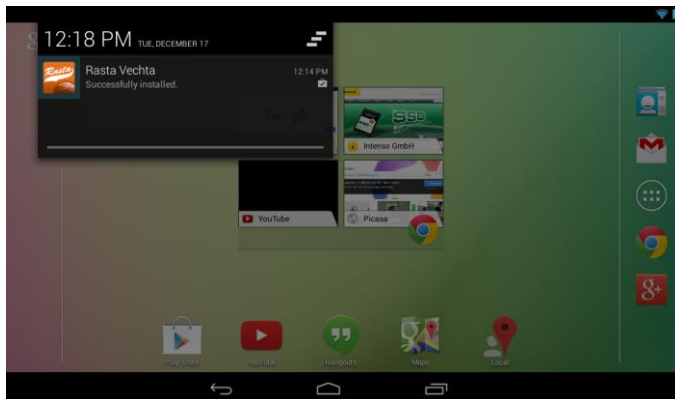

Если Вы опустите строку состояния на **правую сторону**, отобразятся **панели быстрого доступа для настроек**.

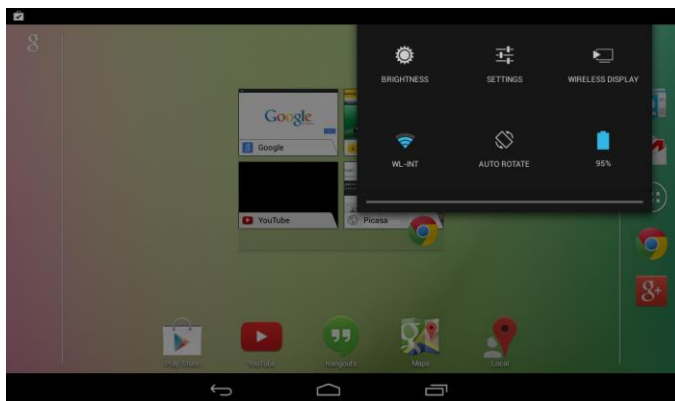

В **нижней строке состояния** Вы можете перейти к **предыдущему экрану** или закрыть **при помощи клавиатуры**, напрямую **вызвать экран запуска**, просмотреть **последние используемые программы** и **изменить громкость устройства**.



Настройка вида стартового экрана

Вы можете очень легко настроить **вид стартового экрана**. Для **удаления иконки** нажмите на неё **пальцем**, удерживая чуть **дольше** и затем **переместите иконку** на появившийся **значок «X»**. Затем **уберите палец с экрана**, и **иконка будет удалена**.

Для **установки иконки на стартовом экране** из **списка приложений** нажмите, **немного удерживая**, на **иконку в списке приложений**, и появится **стартовый экран**. **Передвиньте иконку на желаемое место** и **уберите палец с экрана**. Теперь **иконка добавлена** на стартовый экран. При наложении одной иконки на другую автоматически будет создана папка с обеими иконками. Для отображения всех иконок, входящих в папку, нажмите на неё и выберите необходимую иконку, быстро нажав на неё.

Вы также можете добавить виджеты на экран запуска. Для этого, пожалуйста, откройте обзор приложений. Затем нажмете на слово Виджеты. После этого отобразятся все виджеты, доступные на устройстве. Добавление виджета на экран запуска осуществляется так же, как и добавление значка.

Для изменения фоновой заставки просто нажмите на любое свободное пространство стартового экрана и удерживайте палец на экране, пока не появится меню выбора фоновой заставки. Затем выберите источник желаемого изображения и действуйте следующим образом:

Использование разных пусковых экранов

У Вас есть возможность **персонализировать пять видов стартовых экранов**. Чтобы **выбрать** нужный стартовый экран, **пролистайте по экрану слева направо или наоборот**.

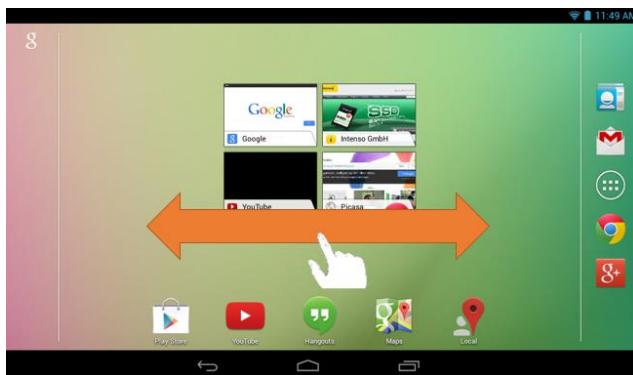

Нажав кнопку Home вы всегда возвращаетесь в средний исходный пусковой экран

Предустановленные приложения на пусковом экране



- A Ярлык для поиска в Google™
- B Обзор Закладки для браузера Chrome™
- C связи, Gmail™, Anwendungsübersicht, Chrome™ и Google+™
- D Google Playstore™ , YouTube™ , Hangouts™ , Maps™ и Local™

11.) Обзор приложений



Нажмите коротко на иконку **обзор приложений**, для открытия **обзора приложений**. Теперь вы сможете увидеть все предустановленные и вами уже установленные приложения. Откройте желаемую вами программу с помощью короткого нажатия на соответствующую иконку.

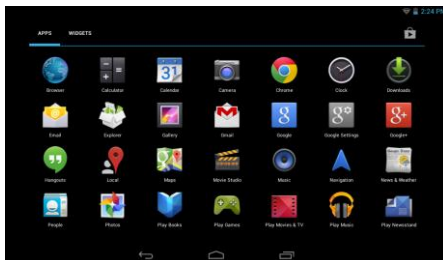

Обзор приложений

12.) Отправка / прием электронных писем

На этом устройстве установленная программа для работы с электронной почтой. С этой программой вы можете использовать уже ваш существующий электронный адрес, для того чтобы отправлять и принимать электронную почту.

Внимание: для этой функции необходимо соединение **WLAN**.

Откройте приложение с помощью иконки „E-Mail“, которую вы сможете найти в меню приложений.

Настройка вашего почтового ящика

- (1) **Запустите** приложение E-Mail помощью нажатия на символ **E-Mail**. Теперь вам необходимо настроить ваш почтовый ящик.
- (2) Введите ваш актуальный электронный адрес и соответствующий пароль и нажмите на „**далее**“. Заведите ваш почтовый ящик и дайте ему название, установите имя и имя для исходящей почты. Нажмите на „**Готово**“ для завершения настройки почтового ящика. Ваш почтовый ящик будет использован как стандартный и исходный почтовый ящик, если вы выберете опцию „**отправлять письма исходя всегда из этого ящика**“.
- (3) Вы также можете настроить ваш почтовый ящик в ручную. Задайте ваш электронный адрес и соответствующий к ящику пароль и нажмите после этого на „**Ручная установка**“. Задайте все необходимые данные и информацию для почтового сервера.
- (4) **Сделайте** выбор между **серверами POP3, IMAP или Exchange** для **входящих электронных писем**.

Внимание: Если вы не знаете какие настройки задавать для правильной работы почтового ящика, контактируйте вашего провайдера, системного администратора или ищите эти названия „POP адрес“ и „Имя провайдера“ в сети интернет для получения точной информации.



- (5) Задайте требуемую информацию (сервер, порт и др.).
- (6) Выберите тип сервера для исходящей почты и задайте всю необходимую информацию. .
- (7) Нажмите на „**Далее**“ для того чтобы **продолжить настройку в меню**. Приложение для электронной почты сейчас проверяет все заданные параметры с настройками сервера. После успешной проверки вы увидите сообщение “Ваш почтовый ящик успешно установлен, поздравляем и желаем хорошей работы”. Ваш почтовый ящик теперь настроен.
- (8) Дайте имя почтовому ящику, нажмите на „**Готово**“ для завершения процедуры.

Внимание: В случае если у вас больше одного почтового ящика, то при загрузке проверяется всегда то, которое выставленное как стандартное или по умолчанию.

Управление учетными записями электронной почты

Добавление нового почтового ящика:

- (1) Для появления **других элементов управления** откройте **приложение Email** и нажмите на **кнопку Меню **. Для введения нового почтового ящика выберите пункт Меню **Настройки** и далее «Новая **учетная запись**».
- (2) Для создания **нового почтового ящика** следуйте **инструкциям мастера настроек**.

Удаление почтового ящика:

- (1) Для вызова **других элементов управления** откройте **приложение Email** и нажмите на **кнопку Меню **. Для удаления выбранного почтового ящика выберите пункт меню «Настройки» и далее «**Удаление учетной записи**».

Проверка свойств учетной записи:

- (1) Для вызова **других элементов управления** откройте **приложение Email** и нажмите на **кнопку Меню **, а затем выберите «**Настройки**». В **левой стороне** меню появятся **все созданные почтовые ящики**.
- (2) Для появления установок учетной записи нажмите на **почтовый ящик**.

Для введения необходимых сведений **нажмите на «Настройки учетной записи», которые необходимо изменить.**

Отображение новостей E-Mail

Откройте приложение с помощью иконки „**E-Mail**“, которую вы сможете найти в меню приложений. Отображается ваш уже установленный **почтовый ящик**.

- С помощью **вертикального** скользящего движения вы можете пролистывать ваши **электронные адреса**.
- Нажмите коротко на **определенный адрес** для того чтобы его открыть.
- Нажмите и держите нажатым на **определенную новость** от вашего почтового ящика, для получения **дальнейших опции** для настройки. Появится **информационное поле**. Здесь вы имеете возможность **электронное письмо** открыть, на него **ответить, переслать или удалить**.

Написание электронных писем

- (1) Нажатием на **значок Email** в **верхней строке Меню** в меню **Email** открывается **новое окно**, в котором Вы сможете написать **новое электронное сообщение**.
- (2) Ведите **электронный адрес получателя, тему и текст** в **соответствующие поля**. Для отправки сообщения нескольким пользователям можно добавить адреса в поля «**Копия/Скрытая копия**».
- (3) Нажмите клавишу «**Отправить**» для **отправки электронного сообщения**. Чтобы **сохранить черновик электронного сообщения**, нажмите «**Сохранить**». Нажатие на **значок «Корзина»** удалит **введённое электронное сообщение**.

13.) Интернет браузер

Для запуска интернет браузера нажмите на иконку с **символом браузера**  в **режиме активного использования на пусковом экране**.

Для открытия интернет странички нажмите на верхнее поле ввода и введите в это поле адрес и название вашей интернет странички. Появится виртуальная клавиатура и вы сможете ввести адрес и название вашей желаемой интернет странички. Когда вы набрали полный адрес, нажмите на кнопку „вперед“ или на **символ стрелочки в поле ввода данных**, с целью запустить вашу желаемую страницу в сети интернет.

Внимание: Не все сети предоставляют соединение с сетью интернет. Некоторые сети предоставляют только выход на локальные устройства и не имеет связь с сетью интернет.

Использование виртуальной клавиатуры

Для открытия виртуальной клавиатуры нажмите на поле ввода информации. Теперь вы можете вводить тексты и открывать интернет странички после ввода корректно адреса.





- Caps Lock (Написание большими буквами)
- Обратно или отменить
- Открыть меню для ввода цифр, знаков и специальных знаков.
- Space Taste (Кнопка для пробела)
- Los (Подтверждение вашего ввода)

Ввод специальных знаков

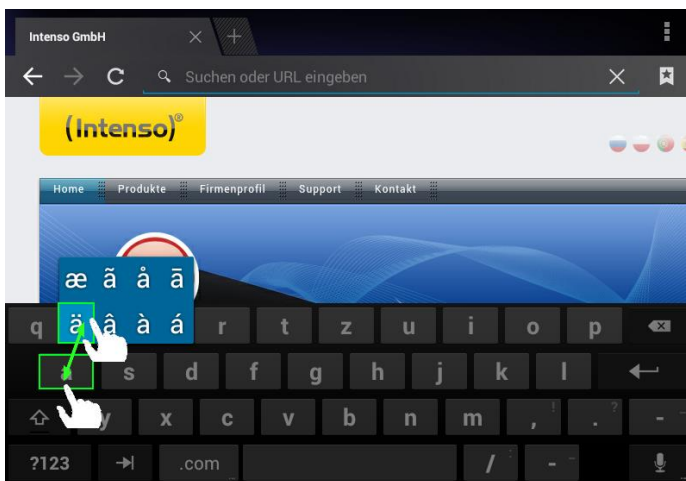
Для ввода **специальных символов** таких, как «ä», **нажмите на кнопку «а»** и удерживайте ее **несколько секунд** для вызова **меню специальных символов**. Затем скользните по экрану к необходимому специальному символу, например, «ä» и уберите палец с экрана. Теперь символ «ä» введен.





Использование интернет браузера

- Вы имеете возможность **прокрутить** экран вниз. Для этого выполните вертикальное движение пальцем вниз. Не начинайте выполнять движение **прокрутки** на кнопке меню или ссылке, иначе будет открыта следующая **программа** вместо **прокрутки дисплея**.
- Для того, чтобы **открыть ссылку** в интернет, нажмите просто на ссылку. Страница будет открыта **автоматический**.
- Для открытия **Меню веб-браузера**, нажмите на кнопку **Меню** . В Меню представлены различные функции. Здесь можно также **обновить открытую веб-страницу, открыть новую вкладку, выбрать автономный режим для чтения веб-страниц** и сменить **настройки веб-браузера**.
- Для возврата на обратную страницу, нажмите на кнопку **назад** .
- Чтобы вернуться напрямую на экран запуска, нажмите на кнопку **Home** .
- Для ввода текста нажмите на соответствующее поле и используйте **виртуальную клавиатуру** для **ввода текста** в поле.

Внимание: для этой функции необходимо соединение **WLAN**.

14.) Системные настройки

Для вызова **системы установок** нажмите в **меню приложений** на иконку **Настройки**.

- На **левой стороне меню** находятся отдельные **категории**. Для вызова **списка настроек** необходимо **коротко нажать** на соответствующий **элемент меню**. Обратите внимание, что, возможно, не все функции, предлагаемые Android™, представлены в данном устройстве.
- После внесения всех изменений в настройки, нажав на кнопку **Назад** , можно **вернуться вранее вызванное меню**, или при помощи **кнопки Домой**  вернуться сразу на стартовый экран. Данные, введенные Вами, будут автоматически сохранены.

Обзор настроек

Беспроводное соединение и сети	Беспроводная локальная сеть	Настройки беспроводной локальной сети
	Больше	Другие настройки сети
Устройство	Сигналы	Настройка громкости звука и сигнала сообщений. Активировать/деактивировать сигнал-подтверждение при касании экрана и сигнал-оповещение при снятии блокировки экрана
	Экран	Яркость – настройка яркости экрана Фон – выбор фона поворота экрана при повороте устройства Режим ожидания – настройка времени задержки перед автоматическим отключением экрана Размер шрифта – настроить желаемый размер шрифта
	Накопитель	Информация о внутреннем накопителе и, карте памяти, если она установлена. Кроме того, Вы можете удалить информацию с накопителя
	Аккумулятор	Информация о состоянии загрузки встроенного аккумулятора
	Приложения	Управление приложениями и информация о них.
Пользователь	Службы местоположения	Разрешение использования приложений Android™ для определения Вашего местоположения при помощи беспроводных сетей (например, карт Google™). Разрешение/запрещение выведения результатов поиска Google™ относительно Вашего местоположения
	Безопасность	Установка блокировки экрана и другие настройки безопасности.
	Язык и ввод данных	Выбор языка, добавление слов в личный словарь, изменение настроек клавиатуры
	Сохранение и восстановление	Сохранение всех настроек системы и данных приложений на сервере Google™ с дальнейшей возможностью восстановления всех текущих настроек. ВНИМАНИЕ: При этом все данные, сохранённые на устройстве, будут удалены
Счета	Добавление счета	Добавление различных счетов.
Система	Дата и время	Настройки даты, времени, часового пояса и формата их отображения
	О планшете	Информация об устройстве

15.) Управление приложениями

Установленные приложения

Устройство поставляется с уже заранее установленными программами. Обзор этих приложений находится в **обзоре приложений** . К этим программам относятся **видео проигрыватель, аудио проигрыватель, интернет браузер, будильник, калькулятор и еще несколько других программ.** Для открытия одного из этих приложений, просто нажмите на него или соответствующий логотип.

Установка приложений разного назначения

Для установки приложений на вашем устройстве, выполните, пожалуйста, следующие процедурные шаги:

- (1) Откройте **нужный источник для загрузки приложений**, например, предварительно установленный **Google Playstore™**. Для этого сначала войдите в **существующую учетную запись Playstore™** или создайте **новую учетную запись Playstore™**. Следуйте **инструкциям на экране**.
- (2) После **успешного входа в систему** Вы увидите большой выбор приложений из **Google Playstore™**. Выберите **необходимое приложение**, нажмите на **установку** и **подтвердите право доступа** к данному приложению. Начнется **загрузка, прогресс** которой будет отображаться в верхнем левом углу расширенной **строки состояния**.
- (3) После **загрузки** приложение **установится** автоматически. Вы можете найти новое **приложение в меню приложений** после успешного завершения установки. **Прогресс установки** будет отображаться в верхнем левом углу расширенной **строки состояния**.

Удаление приложений.





- (1) В списке приложений откройте **Настройки системы, короткого нажав на иконку «Настройки»**.
- (2) Выберите **«Приложения»** в меню, чтобы перейти к **настройкам приложений**.
- (3) При помощи короткого **нажатия** выберите необходимый список приложений из верхних пунктов меню **«Загруженные, USB-накопитель, Активные, Все»**.
- (4) Затем при помощи **короткого нажатия** выберите **приложение**, которое следует удалить.
- (5) Нажмите на **«Удалить»** и **подтвердите ввод**, нажав на **ОК**, для удаления **приложения с устройства**.

Внимание: Предустановленные программы удалению не подлежат.

16.) Обзорщик файлов

Откройте обзор приложений и нажмите на иконку с надписью **обзорщик файлов** для запуска данного приложения.

Навигация сквозь данные и папки

- Вам предоставлены внутренняя память (внутренняя память), **карта памяти** (SD карта) а также **USB** на выбор. Нажмите на желаемый носитель информации для отображения на нем всех содержащихся документов и файлов в виде списка. Если к вашему устройству не подключено никаких **карт памяти** или других средств хранения информации, тогда вы получите сообщение „... устройство не подключено“.
- С помощью вертикального скользящего движения вы можете прокручивать все папки и файлы. Откройте файл или папку в помощью легкого нажатия.
- Вы можете возвратиться всегда на шаг назад  или вперед  с помощью нажатия на соответствующую иконку.
- Для перемещения на один уровень выше в структуре данных , нажмите коротко на иконку **Выше на один уровень** .
- С помощью иконки **Home**  вы напрямую попадете в главное меню вашего каталога данных.

Использовать инструментальную панель

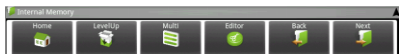



Для скрытия и отображения **панели инструментов** нажмите на **кнопку Меню** , и «Скрыть панель» инструментов».

Home	Напрямую в домашнюю директорию каталога.
LevelUp	На один уровень выше.
Multi	Выбор нескольких файлов.
Editor	Копировать, удалять, перемещать, вставлять и переименовывать данные, файлы или папки.
New Folder	Создать новую папку.
Back	На один шаг назад
Next	На один шаг вперед

Копировать, перемещать и переименовывать данные

- 1.) **Перейдите к вашим желаемым данным** в обзоре и просмотре файлов.
- 2.) Нажмите и удерживайте нажатым палец на файле до тех пор, пока не появится информационное поле.
- 3.) Выберите теперь желаемую функцию. Вы можете выбрать между **Копировать** (Copy), **Удалить** (Delete), **Переместить** (Move), **Вставить** (Paste) – для этого файл должен находится во **временном разделе**, и **Переименовать** (Rename).
- 4.) Для **копирования** или **перемещения соответствующего значки** нажмите на соответствие **иконки** (Copy / Move) и **перейдите** в ключевое и конечное расписание вашей директории. После этого нажмите на иконку **Правка**  и выберите с помощью короткого нажатия **„Вставить“**, для того чтобы переместить файл.
- 5.) Для удаления файла нажмите на **„Удалить“** и **подтвердите** в целях безопасности **еще раз** повторно команду **„Удалить“**. Для отмены нажмите коротко на **„Отменить“**.

- 6.) Для **переименования** одного **файла** нажмите на „**Переименовать**“ и введите через виртуальную клавиатуру **новое название вашего файла или папки**. Подтвердите ваш выбор с помощью нажатия кнопки „**ОК**“ или отмените процедуру с помощью нажатия на кнопку „**Отменить**“.
- 7.) Вы можете одновременно несколько файлов **копировать, удалять или перемещать**. Нажмите для этого на иконку **Мульти**  и за этим на ваши желаемые объекты для операции. Выбранные файлы будут отображены теперь в другом цвете. Нажмите также на иконку **Изменить** , для того чтобы совершить желаемую операцию.

17.) Ограничение гарантийного срока

Гарантия покрывает только возмещение продукта Интензо. Гарантия не покрывает и не обеспечивает возмещение явлений предусмотренного износа, который возник по причине ошибочного применения или использования устройства не в предусмотренных целях, а так же царапин, падении, несовместимости с другими устройствами или пот причине вредоносного использования вместе с какими либо программными или внешними устройствами, сопряженными с вашим устройством.

Гарантия также не действительна при нарушении каких либо из шагов или правил по использованию устройства Интензо согласно инструкции по эксплуатации, а также при нанесении дефекта при установке или использовании через третьи предметы.

При создании условия электрический- статистических разрядов, нагрева или охлаждения за рамками технической спецификации продукта, гарантийный срок перестает действовать.

Интензо не несет ответственность за потерю данных или любых других сопровождающих повреждений или последствий, которые приводят к нарушению условий гарантийного срока.

Этот продукт не предназначен для использования в коммерческих или медицинских целях, а также для специального применения, в котором сбой устройства может привести к повреждениям, смерти или имущественному ущербу.

18.) Технические данные

CPU	1.0 GHz Dualcore based on Cortex A9
Оперативная память	1 GB DDR 3
Операционная система	Android 4.2.2
Совместимые системы	Windows XP / Vista / 7 / 8 / Linux 2,4 или выше / Mac 10.6 или выше
Подключения	наушники, Micro SD (SDHC/SDXC), micro USB
WLAN	WiFi (802.11 b/g/n)
G-сенсор	360 градусов
Формат фотографий	JPEG, BMP, GIF, PNG
Формат аудио	MP3, WMA, WAV, OGG, FLAC, APE
Формат видео	MPEG1, MPEG 4, FLV
Экран	TFT LCD экран, 1024 x 600 пикселей
Камера	0,3 МП, передняя камера
SNR	>= 80 dB
Диапазон частот	20 Гц – 20 КГц
Сетевой адаптер	(V) AC Adapter (HUONIO HNBC050120UE): AC Input 100-240V~50/60Hz, DC Output 5V / 1.2A
Встроенный аккумулятор	Заряжаемый аккумулятор Lithium-Ionen Polymer

19.) Обслуживание устройства

Опрыскивание или нанесение жидкости на поверхность устройства строго запрещено. Никогда не наносите жидкость на экран или корпус данного устройства.

20.) Очистка устройства

Протирать устройство, экран и корпус мягкой, натуральной, чистой и сухой тканью. Используйте только те средства ухода, которые специально предназначены для сенсорных экранов.

21.) Утилизация электрического оборудования

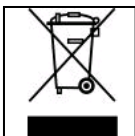

Все устройства имеющие данную маркировку принадлежат к списку товаров включенных в директиву ЕС 2002/96/. Все электротовары и устаревшие электротовары утилизируются отдельно от домашнего мусора на специально оборудованных точках или государственных местах утилизации и переработки. Соблюдая порядок утилизации вы сохраняете природу окружающей среды.

(Intenso)[®]

49377 Vechta
Germany
www.intenso.de



22.) лицензия информация

Notice of GNU GENERAL PUBLIC LICENSE and LESSER GENERAL PUBLIC LICENCE

Dear Customer,

If interested, you and any third party can download the source code of used GPL / LGPL from Intenso Webpage <http://www.intenso.de>. The source code of the desired product is available to anyone on the selection of valid product category and the desired device. In the product details you will find the entry "drivers". Open this menu to download the corresponding GPL / LGPL code. For a fee of 35 € (delivery to another country as Germany), it is also possible to obtain this code by postal delivery. More information about the GPL/LGPL-Licence can you find on following website www.gnu.org

GNU GENERAL PUBLIC LICENSE

Version 2, June 1991

Copyright (C) 1989, 1991 Free Software Foundation, Inc.

51 Franklin Street, Fifth Floor, Boston, MA 02110-1301, USA

Everyone is permitted to copy and distribute verbatim copies of this license document, but changing it is not allowed.

Preamble

The licenses for most software are designed to take away your freedom to share and change it. By contrast, the GNU General Public License is intended to guarantee your freedom to share and change free software--to make sure the software is free for all its users. This General Public License applies to most of the Free Software Foundation's software and to any other program whose authors commit to using it. (Some other Free Software Foundation software is covered by the GNU Lesser General Public License instead.) You can apply it to your programs, too.

When we speak of free software, we are referring to freedom, not price. Our General Public Licenses are designed to make sure that you have the freedom to distribute copies of free software (and charge for this service if you wish), that you receive source code or can get it if you want it, that you can change the software or use pieces of it in new free programs; and that you know you can do these things.

To protect your rights, we need to make restrictions that forbid anyone to deny you these rights or to ask you to surrender the rights. These restrictions translate to certain responsibilities for you if you distribute copies of the software, or if you modify it.

For example, if you distribute copies of such a program, whether gratis or for a fee, you must give the recipients all the rights that you have. You must make sure that they, too, receive or can get the source code. And you must show them these terms so they know their rights.

We protect your rights with two steps: (1) copyright the software, and (2) offer you this license which gives you legal permission to copy, distribute and/or modify the software.

Also, for each author's protection and ours, we want to make certain that everyone understands that there is no warranty for this free software. If the software is modified by someone else and passed on, we want its recipients to know that what they have is not the original, so that any problems introduced by others will not reflect on the original authors' reputations.

Finally, any free program is threatened constantly by software patents. We wish to avoid the danger that redistributors of a free program will individually obtain patent licenses, in effect making the program proprietary. To prevent this, we have made it clear that any patent must be licensed for everyone's free use or not licensed at all.

The precise terms and conditions for copying, distribution and modification follow.

TERMS AND CONDITIONS FOR COPYING, DISTRIBUTION AND MODIFICATION

0. This License applies to any program or other work which contains a notice placed by the copyright holder saying it may be distributed under the terms of this General Public License. The "Program", below, refers to any such program or work, and a "work based on the Program" means either the Program or any derivative work under copyright law: that is to say, a work containing the Program or a portion of it, either verbatim or with modifications and/or translated into another language. (Hereinafter, translation is included without limitation in the term "modification".) Each licensee is addressed as "you".

Activities other than copying, distribution and modification are not covered by this License; they are outside its scope. The act of running the Program is not restricted, and the output from the Program is covered only if its contents constitute a work based on the Program (independent of having been made by running the Program). Whether that is true depends on what the Program does.

1. You may copy and distribute verbatim copies of the Program's source code as you receive it, in any

medium, provided that you conspicuously and appropriately publish on each copy an appropriate copyright notice and disclaimer of warranty; keep intact all the notices that refer to this License and to the absence of any warranty; and give any other recipients of the Program a copy of this License along with the Program. You may charge a fee for the physical act of transferring a copy, and you may at your option offer warranty protection in exchange for a fee.

2. You may modify your copy or copies of the Program or any portion of it, thus forming a work based on the Program, and copy and distribute such modifications or work under the terms of Section 1 above, provided that you also meet all of these conditions:

- a) You must cause the modified files to carry prominent notices stating that you changed the files and the date of any change.
 - b) You must cause any work that you distribute or publish, that in whole or in part contains or is derived from the Program or any part thereof, to be licensed as a whole at no charge to all third parties under the terms of this License.
 - c) If the modified program normally reads commands interactively when run, you must cause it, when started running for such interactive use in the most ordinary way, to print or display an announcement including an appropriate copyright notice and a notice that there is no warranty (or else, saying that you provide a warranty) and that users may redistribute the program under these conditions, and telling the user how to view a copy of this License. (Exception: if the Program itself is interactive but does not normally print such an announcement, your work based on the Program is not required to print an announcement.)
- These requirements apply to the modified work as a whole. If identifiable sections of that work are not derived from the Program, and can be reasonably considered independent and separate works in themselves, then this License, and its terms, do not apply to those sections when you distribute them as separate works. But when you distribute the same sections as part of a whole which is a work based on the Program, the distribution of the whole must be on the terms of this License, whose permissions for other licensees extend to the entire whole, and thus to each and every part regardless of who wrote it. Thus, it is not the intent of this section to claim rights or contest your rights to work written entirely by you; rather, the intent is to exercise the right to control the distribution of derivative or collective works based on the Program.

In addition, mere aggregation of another work not based on the Program with the Program (or with a work based on the Program) on a volume of a storage or distribution medium does not bring the other work under the scope of this License.

3. You may copy and distribute the Program (or a work based on it, under Section 2) in object code or executable form under the terms of Sections 1 and 2 above provided that you also do one of the following:

- a) Accompany it with the complete corresponding machine-readable source code, which must be distributed under the terms of Sections 1 and 2 above on a medium customarily used for software interchange; or,
- b) Accompany it with a written offer, valid for at least three years, to give any third party, for a charge no more than your cost of physically performing source distribution, a complete machine-readable copy of the corresponding source code, to be distributed under the terms of Sections 1 and 2 above on a medium customarily used for software interchange; or,
- c) Accompany it with the information you received as to the offer to distribute corresponding source code. (This alternative is allowed only for noncommercial distribution and only if you received the program in object code or executable form with such an offer, in accord with Subsection b above.)

The source code for a work means the preferred form of the work for making modifications to it. For an executable work, complete source code means all the source code for all modules it contains, plus any associated interface definition files, plus the scripts used to control compilation and installation of the executable. However, as a special exception, the source code distributed need not include anything that is normally distributed (in either source or binary form) with the major components (compiler, kernel, and so on) of the operating system on which the executable runs, unless that component itself accompanies the executable.

If distribution of executable or object code is made by offering access to copy from a designated place, then offering equivalent access to copy the source code from the same place counts as distribution of the source code, even though third parties are not compelled to copy the source along with the object code.

4. You may not copy, modify, sublicense, or distribute the Program except as expressly provided under this License. Any attempt otherwise to copy, modify, sublicense or distribute the Program is void, and will automatically terminate your rights under this License. However, parties who have received copies, or rights, from you under this License will not have their licenses terminated so long as such parties remain in full compliance.

5. You are not required to accept this License, since you have not signed it. However, nothing else grants you permission to modify or distribute the Program or its derivative works. These actions are prohibited by

law if you do not accept this License. Therefore, by modifying or distributing the Program (or any work based on the Program), you indicate your acceptance of this License to do so, and all its terms and conditions for copying, distributing or modifying the Program or works based on it.

6. Each time you redistribute the Program (or any work based on the Program), the recipient automatically receives a license from the original licensor to copy, distribute or modify the Program subject to these terms and conditions. You may not impose any further restrictions on the recipients' exercise of the rights granted herein. You are not responsible for enforcing compliance by third parties to this License.

7. If, as a consequence of a court judgment or allegation of patent infringement or for any other reason (not limited to patent issues), conditions are imposed on you (whether by court order, agreement or otherwise) that contradict the conditions of this License, they do not excuse you from the conditions of this License. If you cannot distribute so as to satisfy simultaneously your obligations under this License and any other pertinent obligations, then as a consequence you may not distribute the Program at all. For example, if a patent license would not permit royalty-free redistribution of the Program by all those who receive copies directly or indirectly through you, then the only way you could satisfy both it and this License would be to refrain entirely from distribution of the Program.

If any portion of this section is held invalid or unenforceable under any particular circumstance, the balance of the section is intended to apply and the section as a whole is intended to apply in other circumstances. It is not the purpose of this section to induce you to infringe any patents or other property right claims or to contest validity of any such claims; this section has the sole purpose of protecting the integrity of the free software distribution system, which is implemented by public license practices. Many people have made generous contributions to the wide range of software distributed through that system in reliance on consistent application of that system; it is up to the author/donor to decide if he or she is willing to distribute software through any other system and a licensee cannot impose that choice. This section is intended to make thoroughly clear what is believed to be a consequence of the rest of this License.

8. If the distribution and/or use of the Program is restricted in certain countries either by patents or by copyrighted interfaces, the original copyright holder who places the Program under this License may add an explicit geographical distribution limitation excluding those countries, so that distribution is permitted only in or among countries not thus excluded. In such case, this License incorporates the limitation as if written in the body of this License.

9. The Free Software Foundation may publish revised and/or new versions of the General Public License from time to time. Such new versions will be similar in spirit to the present version, but may differ in detail to address new problems or concerns.

Each version is given a distinguishing version number. If the Program specifies a version number of this License which applies to it and "any later version", you have the option of following the terms and conditions either of that version or of any later version published by the Free Software Foundation. If the Program does not specify a version number of this License, you may choose any version ever published by the Free Software Foundation.

10. If you wish to incorporate parts of the Program into other free programs whose distribution conditions are different, write to the author to ask for permission. For software which is copyrighted by the Free Software Foundation, write to the Free Software Foundation; we sometimes make exceptions for this. Our decision will be guided by the two goals of preserving the free status of all derivatives of our free software and of promoting the sharing and reuse of software generally.

NO WARRANTY

11. BECAUSE THE PROGRAM IS LICENSED FREE OF CHARGE, THERE IS NO WARRANTY FOR THE PROGRAM, TO THE EXTENT PERMITTED BY APPLICABLE LAW. EXCEPT WHEN OTHERWISE STATED IN WRITING THE COPYRIGHT HOLDERS AND/OR OTHER PARTIES PROVIDE THE PROGRAM "AS IS" WITHOUT WARRANTY OF ANY KIND, EITHER EXPRESSED OR IMPLIED, INCLUDING, BUT NOT LIMITED TO, THE IMPLIED WARRANTIES OF MERCHANTABILITY AND FITNESS FOR A PARTICULAR PURPOSE. THE ENTIRE RISK AS TO THE QUALITY AND PERFORMANCE OF THE PROGRAM IS WITH YOU. SHOULD THE PROGRAM PROVE DEFECTIVE, YOU ASSUME THE COST OF ALL NECESSARY SERVICING, REPAIR OR CORRECTION.

12. IN NO EVENT UNLESS REQUIRED BY APPLICABLE LAW OR AGREED TO IN WRITING WILL ANY COPYRIGHT HOLDER, OR ANY OTHER PARTY WHO MAY MODIFY AND/OR REDISTRIBUTE THE PROGRAM AS PERMITTED ABOVE, BE LIABLE TO YOU FOR DAMAGES, INCLUDING ANY GENERAL, SPECIAL, INCIDENTAL OR CONSEQUENTIAL DAMAGES ARISING OUT OF THE USE OR INABILITY TO USE THE PROGRAM (INCLUDING BUT NOT LIMITED TO LOSS OF DATA OR DATA BEING RENDERED INACCURATE OR LOSSES SUSTAINED BY YOU OR THIRD PARTIES OR A FAILURE OF THE PROGRAM TO OPERATE WITH ANY OTHER PROGRAMS), EVEN IF SUCH HOLDER OR OTHER

PARTY HAS BEEN ADVISED OF THE POSSIBILITY OF SUCH DAMAGES.

END OF TERMS AND CONDITIONS

How to Apply These Terms to Your New Programs

If you develop a new program, and you want it to be of the greatest possible use to the public, the best way to achieve this is to make it free software which everyone can redistribute and change under these terms.

To do so, attach the following notices to the program. It is safest to attach them to the start of each source file to most effectively convey the exclusion of warranty; and each file should have at least the "copyright" line and a pointer to where the full notice is found.

one line to give the program's name and an idea of what it does.

Copyright (C) yyyy name of author

This program is free software; you can redistribute it and/or modify it under the terms of the GNU General Public License as published by the Free Software Foundation; either version 2 of the License, or (at your option) any later version.

This program is distributed in the hope that it will be useful, but WITHOUT ANY WARRANTY; without even the implied warranty of MERCHANTABILITY or FITNESS FOR A PARTICULAR PURPOSE. See the GNU General Public License for more details.

You should have received a copy of the GNU General Public License along with this program; if not, write to the Free Software

Foundation, Inc., 51 Franklin Street, Fifth Floor, Boston, MA 02110-1301, USA.

Also add information on how to contact you by electronic and paper mail.

If the program is interactive, make it output a short notice like this when it starts in an interactive mode:

Gnomovision version 69, Copyright (C) year name of author

Gnomovision comes with ABSOLUTELY NO WARRANTY; for details

type `show w'. This is free software, and you are welcome

to redistribute it under certain conditions; type `show c' for details.

The hypothetical commands `show w' and `show c' should show the appropriate parts of the General Public License. Of course, the commands you use may be called something other than `show w' and `show c'; they could even be mouse-clicks or menu items--whatever suits your program.

You should also get your employer (if you work as a programmer) or your school, if any, to sign a "copyright disclaimer" for the program, if necessary. Here is a sample; alter the names:

Yoyodyne, Inc., hereby disclaims all copyright interest in the program `Gnomovision'

(which makes passes at compilers) written by James Hacker.

signature of Ty Coon, 1 April 1989

Ty Coon, President of Vice

ЕС Заявление о соответствии товара

Мы, компания Интензо ГмбХ,
с местонахождением в Германии, город Вехта, улица Дипхольцерштрассе 15,

заявляем на собственной ответственности, что следующий продукт:

Модель: 7" TAB 734 (Номер артикула 5509854)

Описание: Компьютер-планшет

соответствует следующим директивам и стандартам:

Директива R&TTE 1999/5/EC

- EN 301 489-1 V1.9.2
- EN 301 489-17 V2.1.1
- EN 300 328 V1.7.1 : 2006-10
- EN 55022:2010 (Class B)
- EN 55024:2010
- EN 61000-3-2:2006+A1 :2009+A2 :2009 (Class D)
- EN 61000-3-3:2008

Директива низкого напряжения 2006/95/EC

- EN 60950-1:2006+A11:2009+A1:2010+A12:2011+A12: исправление 2012

Директива экологического дизайна 2009/125/EC

- 1275/2008
- 278/2009

Директива ROHS 2011/65/EU

Технические документы на выше приведенную модель данного устройства
находятся в следующем месте:

Интензо ГмбХ
Дипхольцерштрассе 15, 49377 Вехта, Германия

Уполномоченная личность:

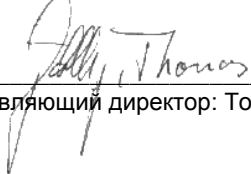

Управляющий директор: Томас Пёлькинг