

N3150I-C
N3050I-C



Motherboard

Copyright © 2015 ASUSTeK COMPUTER INC. All Rights Reserved.

No part of this manual, including the products and software described in it, may be reproduced, transmitted, transcribed, stored in a retrieval system, or translated into any language in any form or by any means, except documentation kept by the purchaser for backup purposes, without the express written permission of ASUSTeK COMPUTER INC. ("ASUS").

Product warranty or service will not be extended if: (1) the product is repaired, modified or altered, unless such repair, modification of alteration is authorized in writing by ASUS; or (2) the serial number of the product is defaced or missing.

ASUS PROVIDES THIS MANUAL "AS IS" WITHOUT WARRANTY OF ANY KIND, EITHER EXPRESS OR IMPLIED, INCLUDING BUT NOT LIMITED TO THE IMPLIED WARRANTIES OR CONDITIONS OF MERCHANTABILITY OR FITNESS FOR A PARTICULAR PURPOSE. IN NO EVENT SHALL ASUS, ITS DIRECTORS, OFFICERS, EMPLOYEES OR AGENTS BE LIABLE FOR ANY INDIRECT, SPECIAL, INCIDENTAL, OR CONSEQUENTIAL DAMAGES (INCLUDING DAMAGES FOR LOSS OF PROFITS, LOSS OF BUSINESS, LOSS OF USE OR DATA, INTERRUPTION OF BUSINESS AND THE LIKE), EVEN IF ASUS HAS BEEN ADVISED OF THE POSSIBILITY OF SUCH DAMAGES ARISING FROM ANY DEFECT OR ERROR IN THIS MANUAL OR PRODUCT.

SPECIFICATIONS AND INFORMATION CONTAINED IN THIS MANUAL ARE FURNISHED FOR INFORMATIONAL USE ONLY, AND ARE SUBJECT TO CHANGE AT ANY TIME WITHOUT NOTICE, AND SHOULD NOT BE CONSTRUED AS A COMMITMENT BY ASUS. ASUS ASSUMES NO RESPONSIBILITY OR LIABILITY FOR ANY ERRORS OR INACCURACIES THAT MAY APPEAR IN THIS MANUAL, INCLUDING THE PRODUCTS AND SOFTWARE DESCRIBED IN IT.

Products and corporate names appearing in this manual may or may not be registered trademarks or copyrights of their respective companies, and are used only for identification or explanation and to the owners' benefit, without intent to infringe.

Offer to Provide Source Code of Certain Software

This product contains copyrighted software that is licensed under the General Public License ("GPL"), under the Lesser General Public License Version ("LGPL") and/or other Free Open Source Software Licenses. Such software in this product is distributed without any warranty to the extent permitted by the applicable law. Copies of these licenses are included in this product.

Where the applicable license entitles you to the source code of such software and/or other additional data, you may obtain it for a period of three years after our last shipment of the product, either

(1) for free by downloading it from <http://support.asus.com/download>

or

(2) for the cost of reproduction and shipment, which is dependent on the preferred carrier and the location where you want to have it shipped to, by sending a request to:

ASUSTeK Computer Inc.
Legal Compliance Dept.
15 Li Te Rd.,
Beitou, Taipei 112
Taiwan

In your request please provide the name, model number and version, as stated in the About Box of the product for which you wish to obtain the corresponding source code and your contact details so that we can coordinate the terms and cost of shipment with you.

The source code will be distributed WITHOUT ANY WARRANTY and licensed under the same license as the corresponding binary/object code.

This offer is valid to anyone in receipt of this information.

ASUSTeK is eager to duly provide complete source code as required under various Free Open Source Software licenses. If however you encounter any problems in obtaining the full corresponding source code we would be much obliged if you give us a notification to the email address gpl@asus.com, stating the product and describing the problem (please DO NOT send large attachments such as source code archives, etc. to this email address).

Contents

Safety information.....	iv
About this guide.....	iv
Package contents.....	vi
N3150I-C / N3050I-C specifications summary	vi

Chapter 1: Product introduction

1.1 Before you proceed.....	1-1
1.2 Motherboard overview.....	1-2
1.3 Central Processing Unit (CPU).....	1-4
1.4 System memory.....	1-4
1.5 Expansion slots.....	1-7
1.6 Headers	1-8
1.7 Connectors.....	1-10
1.8 Software support.....	1-18
1.9 Windows® 7 and USB 3.0 driver installation	1-19

Chapter 2: BIOS information

2.1 Managing and updating your BIOS.....	2-1
2.2 BIOS setup program.....	2-6
2.3 My Favorites.....	2-10
2.4 Main menu.....	2-12
2.5 Advanced menu.....	2-14
2.6 Monitor menu.....	2-20
2.7 Boot menu.....	2-23
2.8 Tool menu	2-29
2.9 Exit menu	2-30

Appendices

Notices	A-1
ASUS contact information.....	A-4

Safety information

Electrical safety

- To prevent electrical shock hazard, disconnect the power cable from the electrical outlet before relocating the system.
- When adding or removing devices to or from the system, ensure that the power cables for the devices are unplugged before the signal cables are connected. If possible, disconnect all power cables from the existing system before you add a device.
- Before connecting or removing signal cables from the motherboard, ensure that all power cables are unplugged.
- Seek professional assistance before using an adapter or extension cord. These devices could interrupt the grounding circuit.
- Ensure that your power supply is set to the correct voltage in your area. If you are not sure about the voltage of the electrical outlet you are using, contact your local power company.
- If the power supply is broken, do not try to fix it by yourself. Contact a qualified service technician or your retailer.

Operation safety

- Before installing the motherboard and adding devices on it, carefully read all the manuals that came with the package.
- Before using the product, ensure all cables are correctly connected and the power cables are not damaged. If you detect any damage, contact your dealer immediately.
- To avoid short circuits, keep paper clips, screws, and staples away from connectors, slots, sockets and circuitry.
- Avoid dust, humidity, and temperature extremes. Do not place the product in any area where it may become wet.
- Place the product on a stable surface.
- If you encounter technical problems with the product, contact a qualified service technician or your retailer.

About this guide

This user guide contains the information you need when installing and configuring the motherboard.

How this guide is organized

This guide contains the following parts:

- **Chapter 1: Product introduction**
This chapter describes the features of the motherboard and the new technology it supports.
- **Chapter 2: BIOS information**
This chapter tells how to change system settings through the BIOS Setup menus. Detailed descriptions of the BIOS parameters are also provided.

Where to find more information

Refer to the following sources for additional information and for product and software updates.

1. ASUS websites

The ASUS website provides updated information on ASUS hardware and software products. Refer to the ASUS contact information.

2. Optional documentation

Your product package may include optional documentation, such as warranty flyers, that may have been added by your dealer. These documents are not part of the standard package.

Conventions used in this guide

To ensure that you perform certain tasks properly, take note of the following symbols used throughout this manual.



DANGER/WARNING: Information to prevent injury to yourself when trying to complete a task.



CAUTION: Information to prevent damage to the components when trying to complete a task.



IMPORTANT: Instructions that you **MUST** follow to complete a task.



NOTE: Tips and additional information to help you complete a task.

Typography

Bold text

Indicates a menu or an item to select.

Italics

Used to emphasize a word or a phrase.

<Key>

Keys enclosed in the less-than and greater-than sign means that you must press the enclosed key.

Example: <Enter> means that you must press the Enter or Return key.

<Key1> + <Key2> + <Key3>

If you must press two or more keys simultaneously, the key names are linked with a plus sign (+).

Package contents

Check your motherboard package for the following items.

Motherboard	ASUS N3150I-C or N3050I-C motherboard
Cables	2 x Serial ATA 6.0 Gb/s cables
Accessories	1 x I/O Shields
Application DVD	Support DVD
Documentation	User Guide



If any of the above items is damaged or missing, contact your retailer.

N3150I-C / N3050I-C specifications summary

CPU	N3150I-C: Intel® Celeron® Quad-core Processor N3150 (Code Name: Braswell) N3050I-C: Intel® Celeron® Dual-core Processor N3050 (Code Name: Braswell)
Memory	2 x U-DIMM DDR3 1600/1066 MHz, Max 8GB, non-ECC, un-buffered memory Dual-channel memory architecture * Refer to www.asus.com for the latest Memory QVL (Qualified Vendors List).
Graphics	Integrated Graphics Processor- Intel® HD Graphics support Multi-VGA output support: HDMI, D-Sub, LVDS <ul style="list-style-type: none">- Supports HDMI with max. resolution of 3840 x 2160 @30Hz- Supports D-sub with max. resolution of 1920 x 1200 @60Hz- Supports LVDS with max. resolution of 1920 x 1200 @60Hz- Maximum shared memory of 512MB * With DX11.1, OGL 4.2 support ** Support H.264, MPEG2, MVC, VC-1, WMV9, and VP8 decode acceleration
Expansion slots	1 x PCI Express x4 slot (@x1 mode) 1 x Mini PCI Express slot (Half-length)
Storage	2 x SATA 6.0Gb/s connectors
LAN	Realtek® RTL8111H Gigabit LAN controller
Audio	Realtek® ALC887 8-channel High Definition Audio CODEC <ul style="list-style-type: none">- Supports Jack-Detection, and Front Panel Jack-Retasking * Use a chassis with HD audio module in the front panel to support an 8-channel audio output.
USB	4 x USB 3.0/2.0 ports (2 at mid-board, 2 at back panel) 4 x USB 2.0/1.1 ports (2 at mid-board, 2 at back panel)

(continued on the next page)

N3150I-C / N3050I-C specifications summary

ASUS Unique Features	ASUS Exclusive Features <ul style="list-style-type: none"> - ASUS Anti-surge Protection - ASUS AI Suite 3 - ASUS USB 3.0 Boost ASUS Quiet Thermal Solution <ul style="list-style-type: none"> - ASUS Fan Xpert - Fanless Heatsink Design ASUS EZ DIY <ul style="list-style-type: none"> - ASUS UEFI BIOS - ASUS MyLogo 2 - ASUS EZ-Flash 2 - ASUS Crash Free BIOS3 100% All High-quality Conductive Polymer Capacitors
Back Panel I/O Ports	<ul style="list-style-type: none"> 1 x PS/2 keyboard port (purple) 1 x PS/2 mouse port (green) 1 x HDMI port 1 x D-Sub port 1 x COM port 2 x USB 3.0/2.0 ports 2 x USB 2.0/1.1 ports 1 x Gigabit LAN (RJ-45) port 3 x Audio jacks support 8-channel audio output
Internal I/O Connectors	<ul style="list-style-type: none"> 1 x USB 2.0/1.1 connectors support additional 2 USB 2.0/1.1 ports 1 x USB 3.0/2.0 connectors support additional 2 USB 3.0/2.0 ports 2 x SATA 6.0Gb/s connectors 1 x Chassis fan connector 1 x CPU fan connector 1 x Chassis intrusion connector 1 x Front panel audio connector 1 x COM connector 1 x LPT connector 1 x TPM connector 1 x 24-pin EATX power connector 1 x 4-pin EATX 12V power connector 1 x Buzzer 1 x LVDS connector 1 x System panel connector
BIOS features	64Mb Flash ROM, UEFI AMI BIOS, PnP, DMI2.0, WfM2.0, SM BIOS 2.7, ACPI 2.0a, Multi-language BIOS, ASUS EZ Flash 2, ASUS CrashFree BIOS 3, My Favorites, Quick Note, Last Modified log, F12 PrintScreen, F3 Shortcut functions and ASUS DRAM SPD (Serial Presence Detect) memory information
Manageability	WfM 2.0, DMI 2.0, WOL by PME, PXE
Operating System Support	Windows® 8.1 64-bit, Window® 7 64-bit

(continued on the next page)

N3150I-C / N3050I-C specifications summary

Support DVD	Drivers ASUS utilities EZ Update Anti-virus software (OEM version)
Form factor	Mini-ITX Form Factor, 6.7" x 6.7" (17cm x 17cm)



Specifications are subject to change without notice.

Product introduction

1

1.1 Before you proceed

Take note of the following precautions before you install motherboard components or change any motherboard settings.



-
- Unplug the power cord from the wall socket before touching any component.
 - Before handling components, use a grounded wrist strap or touch a safely grounded object or a metal object, such as the power supply case, to avoid damaging them due to static electricity.
 - Hold components by the edges to avoid touching the ICs on them.
 - Whenever you uninstall any component, place it on a grounded antistatic pad or in the bag that came with the component.
 - Before you install or remove any component, ensure that the ATX power supply is switched off or the power cord is detached from the power supply. Failure to do so may cause severe damage to the motherboard, peripherals, or components.
-

1.2 Motherboard overview

Before you install the motherboard, study the configuration of your chassis to ensure that the motherboard fits into it.



Ensure that you unplug the power cord before installing or removing the motherboard. Failure to do so can cause you physical injury and damage motherboard components.

1.2.1 Placement direction

When installing the motherboard, ensure that you place it into the chassis in the correct orientation. The edge with external ports goes to the rear part of the chassis as indicated in the image below.

1.2.2 Screw holes

Place four screws into the holes indicated by circles to secure the motherboard to the chassis.



Do not overtighten the screws! Doing so can damage the motherboard.

Place this side towards
the rear of the chassis

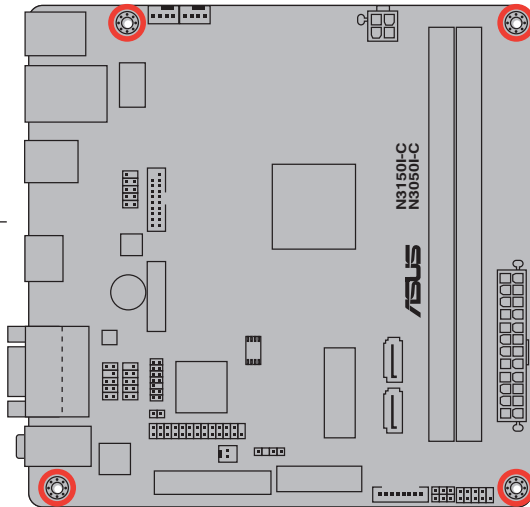

1.2.3 Motherboard layout

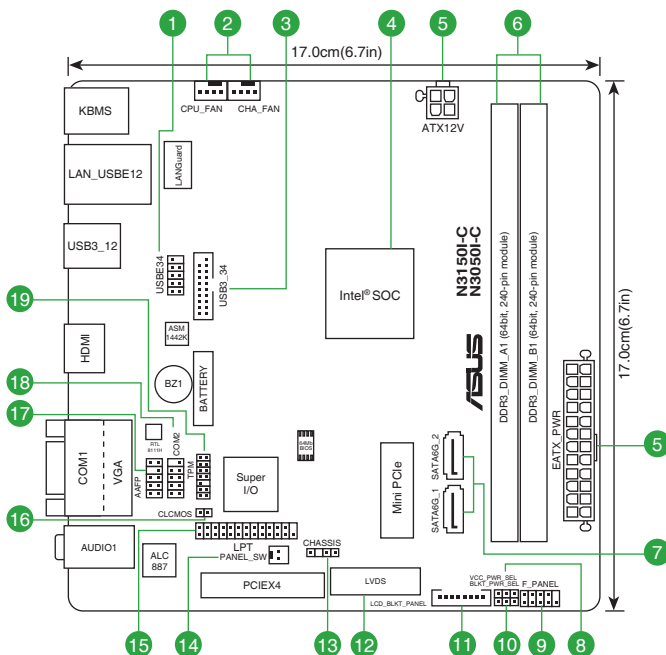

1.2.4 Layout contents

Connectors/Jumpers/Slots/LED	Page
1. USB 2.0 connector (10-pin USBE34)	1-14
2. CPU and chassis fan connectors (4-pin CPU_FAN, 4-pin CHA_FAN)	1-12
3. USB 3.0 connector (20-1 pin USB3_34)	1-14
4. N3150I-C : Intel® Celeron Quad-core Processor N3150 N3050I-C : Intel® Celeron Dual-core Processor N3050	1-4
5. ATX power connectors (24-pin EATXPWR, 4-pin ATX12V)	1-13
6. DDR3 U-DIMM sockets	1-4
7. Serial ATA 6.0Gb/s connectors (7-pin SATA6G_1, SATA6G_2)	1-15
8. Display panel VCC power selector (3-pin VCC_PWR_SEL)	1-8
9. System panel connector (10-1 pin F_PANEL)	1-15
10. Display panel backlight power selector (3-pin BLKT_PWR_SEL)	1-9
11. Flat panel display brightness (8-pin LCD_BLK_PANEL)	1-16
12. LVDS connector (40-pin LVDS)	1-16
13. Chassis intrusion connector (4-1 pin CHASSIS)	1-9
14. Display panel power connector (2-pin PANEL_SW)	1-16
15. LPT connector (26-1 pin LPT)	1-17
16. Clear RTC RAM (2-pin CLCMOS)	1-8
17. Front panel audio connector (10-1 pin AAFP)	1-11
18. Serial port connector (10-1 pin COM2)	1-12
19. TPM connector (14-1 pin TPM)	1-13

1.3 Central Processing Unit (CPU)

The motherboard comes with an onboard Intel® Celeron Quad-core/ Dual-core processor and a specially designed CPU heatsink.

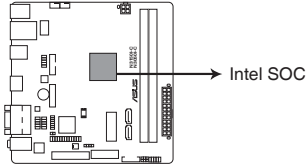

N3150I-C / N3050I-C CPU



N3150I-C with Intel SOC N3150. N3050I-C with Intel SOC N3050.

1.4 System memory

1.4.1 Overview

This motherboard comes with two Double Data Rate 3 (DDR3) U-DIMM sockets. The figure illustrates the location of the DDR3 U-DIMM sockets:

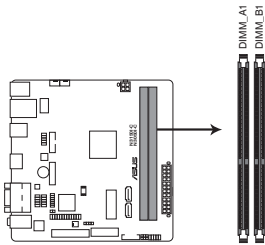

N3150I-C / N3050I-C 240-pin DDR3 DIMM sockets

Channel	Sockets
Channel A	DIMM_A1
Channel B	DIMM_B1



When you install only one memory module, install it to DIMM_A1 slot.

1.4.2 Memory configurations

You may install 1GB, 2GB, 4GB, and 8GB unbuffered non-ECC DDR3 U-DIMMs into the DIMM sockets.



- You may install varying memory sizes in Channel A and Channel B. The system maps the total size of the lower-sized channel for the dual-channel configuration. Any excess memory from the higher-sized channel is then mapped for single-channel operation.
- Always install DIMMs with the same CAS latency. For optimal compatibility, we recommend that you install memory modules of the same version or date code (D/C) from the same vendor. Check with the retailer to get the correct memory modules.
- Due to the memory address limitation on 32-bit Windows® OS, when you install 4GB or more memory on the motherboard, the actual usable memory for the OS can be about 3GB or less. For effective use of memory, we recommend that you do any of the following:
 - Install a maximum of 3GB system memory if you are using a 32-bit Windows® OS.
 - Use a 64-bit Windows® OS if you want to install 4GB or more memory on the motherboard.
 - For more details, refer to the Microsoft® support site at <http://support.microsoft.com/kb/929605/en-us>.
- This motherboard does not support DIMMs made up of 512Mb (64MB) chips or less.



- The default memory operation frequency is dependent on its Serial Presence Detect (SPD), which is the standard way of accessing information from a memory module. Under the default state, some memory modules for overclocking may operate at a lower frequency than the vendor-marked value. To operate at the vendor-marked or at a higher frequency, refer to section **2.5 Ai Tweaker menu** for manual memory frequency adjustment.
- For system stability, use a more efficient memory cooling system to support a full memory load (2 DIMMs) or overclocking condition.
- Refer to www.asus.com for the latest Memory QVL (Qualified Vendors List).

1.4.3 Installing a DIMM

1

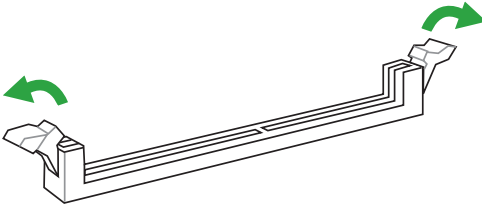

2

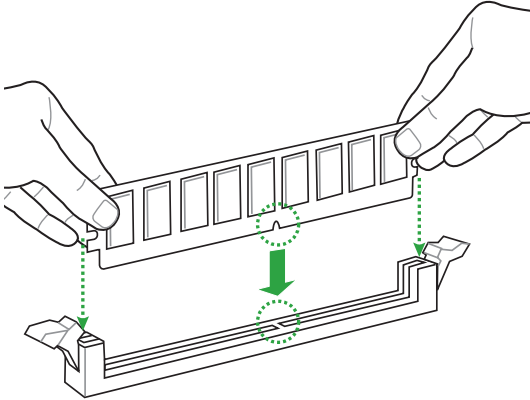

3

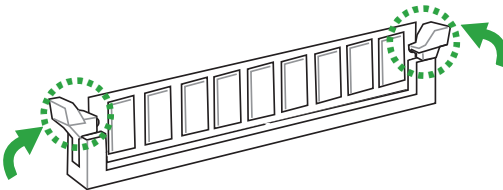

To remove a DIMM

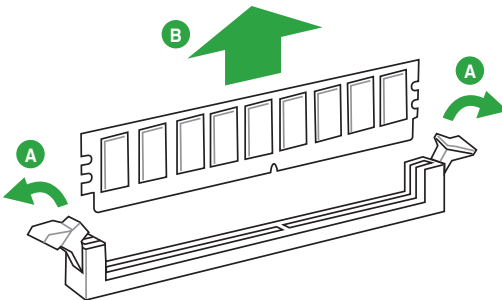

1.5 Expansion slots

In the future, you may need to install expansion cards. The following sub-sections describe the slots and the expansion cards that they support.



Unplug the power cord before adding or removing expansion cards. Failure to do so may cause you physical injury and damage motherboard components.

1.5.1 Installing an expansion card

To install an expansion card:

1. Before installing the expansion card, read the documentation that came with it and make the necessary hardware settings for the card.
2. Remove the system unit cover (if your motherboard is already installed in a chassis).
3. Remove the bracket opposite the slot that you intend to use. Keep the screw for later use.
4. Align the card connector with the slot and press firmly until the card is completely seated on the slot.
5. Secure the card to the chassis with the screw you removed earlier.
6. Replace the system cover.

1.5.2 Configuring an expansion card

After installing the expansion card, configure it by adjusting the software settings.

1. Turn on the system and change the necessary BIOS settings, if any. See Chapter 2 for information on BIOS setup.
2. Assign an IRQ to the card.
3. Install the software drivers for the expansion card.

1.5.3 mini PCIe slot

This mini PCIe slot supports a half length mini PCIe module.

1.5.4 PCI Express 2.0 x4 slot (@x1 mode)

This motherboard supports PCI Express 2.0 x4 network cards, SCSI cards, and other cards that comply with the PCI Express specifications.

IRQ assignments for this motherboard

Component	A	B	C	D	E	F	G	H
PCIe x4	shared	-	-	-	-	-	-	-
Realtek 8111H LAN controller	-	-	shared	-	-	-	-	-
SATA controller	-	-	-	shared	-	-	-	-
HD Audio	-	-	-	-	-	-	shared	-
XHCI controller	-	-	-	-	shared	-	-	-

1.6 Headers

1. Clear RTC RAM (2-pin CLCMOS)

This header allows you to clear the Real Time Clock (RTC) RAM in CMOS. You can clear the CMOS memory of date, time, and system setup parameters by erasing the CMOS RTC RAM data. The onboard button cell battery powers the RAM data in CMOS, which include system setup information such as system passwords.

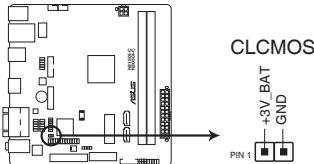

N3150I-C / N3050I-C Clear RTC RAM

To erase the RTC RAM:

1. Turn OFF the computer and unplug the power cord.
2. Use a metal object such as a screwdriver to short the two pins.
3. Plug the power cord and turn ON the computer.
4. Hold down the key during the boot process and enter BIOS setup to re-enter data.



- If the steps above do not help, remove the onboard battery and short the two pins again to clear the CMOS RTC RAM data. After clearing the CMOS, reinstall the battery.
- You do not need to clear the RTC when the system hangs due to overclocking. For system failure due to overclocking, use the CPU Parameter Recall (C.P.R.) feature. Shut down and reboot the system, then the BIOS automatically resets parameter settings to default values.

2. Display panel VCC power selector (3-pin VCC_PWR_SEL)

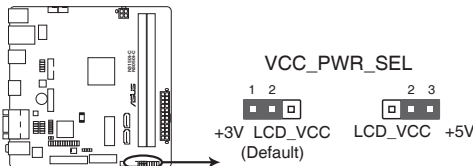

N3150I-C / N3050I-C Display panel VCC power selection

Pins	Setting
1-2 (Default)	+3V
2-3	+5V

3. Chassis intrusion connector (4-1 pin CHASSIS)

This connector is for a chassis-mounted intrusion detection sensor or switch. Connect one end of the chassis intrusion sensor or switch cable to this connector. The chassis intrusion sensor or switch sends a high-level signal to this connector when a chassis component is removed or replaced. The signal is then generated as a chassis intrusion event.

By default, the pins labeled “Intruder” are shorted with a jumper cap. Remove the jumper caps only when you intend to use the chassis intrusion detection feature.

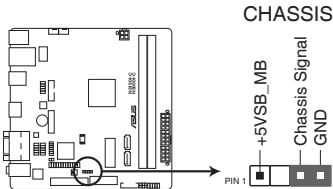

N3150I-C / N3050I-C Chassis intrusion connector

4. Display panel backlight power selector (3-pin BLKT_PWR_SEL)

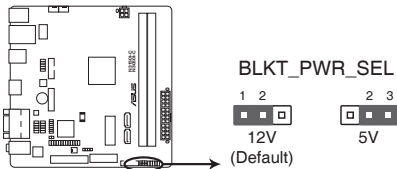

N3150I-C / N3050I-C Display panel backlight power selection

Pins	Setting
1-2 (Default)	12V
2-3	5V

1.7 Connectors

1.7.1 Rear panel connectors

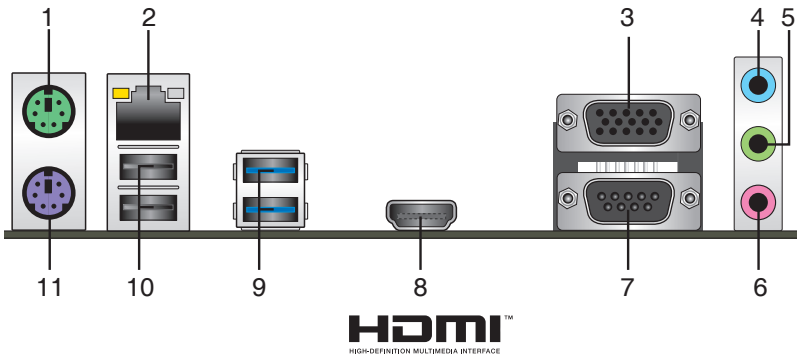

1. **PS/2 mouse port.** This port is for a PS/2 mouse.
2. **LAN (RJ-45) port.** This port allows Gigabit connection to a Local Area Network (LAN) through a network hub. Refer to the table below for the LAN port LED indications.

LAN port LED indications

Activity/Link LED		Speed LED	
Status	Description	Status	Description
Off	No link	OFF	10Mbps connection
Orange	Linked	ORANGE	100Mbps connection
Orange (Blinking)	Data activity	GREEN	1Gbps connection
Orange (Blinking then steady)	Ready to wake up from S5 mode		

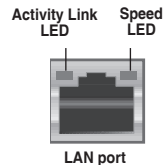

3. **Video Graphics Adapter (VGA) port.** This 15-pin port is for a VGA monitor or other VGA-compatible devices.
4. **Line In port (light blue).** This port connects to a tape, CD, DVD player, or other audio source.
5. **Line Out port (lime).** This port connects to a headphone or a speaker. In the 4.1, 5.1, and 7.1-channel configurations, the function of this port becomes Front Speaker Out.
6. **Microphone port (pink).** This port connects to a microphone.



Refer to the audio configuration table for the function of the audio ports in a 2.1, 4.1, 5.1 or 7.1-channel configuration.

Audio 2.1, 4.1, 5.1 or 7.1-channel configuration

Port	Headset 2.1-channel	4.1-channel	5.1-channel	7.1-channel
Light Blue (Rear panel)	Line In	Rear Speaker Out	Rear Speaker Out	Rear Speaker Out
Lime (Rear panel)	Line Out	Front Speaker Out	Front Speaker Out	Front Speaker Out
Pink (Rear panel)	Mic In	Mic In	Bass/Center	Bass/Center
Lime (Front panel)	—	—	—	Side Speaker Out



To configure a 7.1-channel audio output:

Use a chassis with HD audio module in the front panel to support a 7.1-channel audio output.

7. **Serial port (COM1).** This port connects a modem, or other devices that conform with serial specification.
8. **HDMI port.** This port is for a High-Definition Multimedia Interface (HDMI) connector, and is HDCP compliant allowing playback of HD DVD, Blu-Ray, and other protected content.
9. **USB 3.0 ports 1 and 2.** These two 9-pin Universal Serial Bus (USB) ports are for connecting USB 3.0 devices.
10. **USB 2.0 ports 1 and 2.** These four 4-pin Universal Serial Bus (USB) ports are for USB 2.0/1.1 devices.
11. **PS/2 keyboard port.** This port is for a PS/2 keyboard.

1.7.2 Internal connectors

1. Front panel audio connector (10-1 pin AAFP)

This connector is for a chassis front panel audio I/O module that supports either HD Audio or legacy AC'97 audio standard. Connect one end of the front panel audio I/O module cable to this connector.

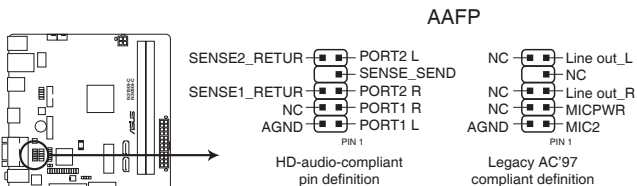

N3150I-C / N3050I-C Front panel audio connector



- We recommend that you connect a high-definition front panel audio module to this connector to avail of the motherboard's high-definition audio capability.
 - If you want to connect a high-definition front panel audio module to this connector, set the **Front Panel Type** item in the BIOS setup to **[HD]**. If you want to connect an AC'97 front panel audio module to this connector, set the item to **[AC97]**. By default, this connector is set to **[HD Audio]**. See section **2.5.7 Onboard Devices Configuration** for details.
-

2. Serial port connector (10-1 pin COM1)

This connector is for a serial (COM) port. Connect the serial port module cable to this connector, then install the module to a slot opening at the back of the system chassis.

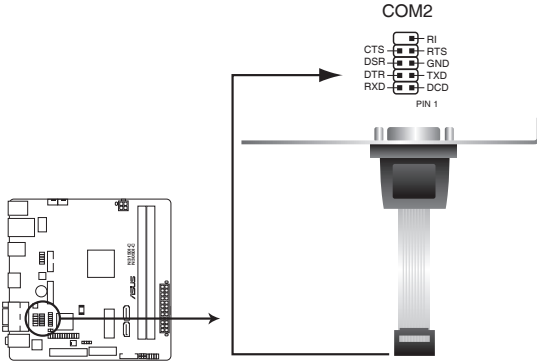

N3150I-C / N3050I-C Serial port connector



The COM module is purchased separately.

3. CPU and chassis fan connectors (4-pin CPU_FAN, 4-pin CHA_FAN)

Connect the fan cables to the fan connectors on the motherboard, ensuring that the black wire of each cable matches the ground pin of the connector.

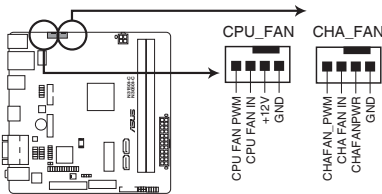

N3150I-C / N3050I-C Fan connectors



Do not forget to connect the fan cables to the fan connectors. Insufficient air flow inside the system may damage the motherboard components. These are not jumpers! Do not place jumper caps on the fan connectors!

4. ATX power connectors (24-pin EATXPWR, 4-pin ATX12V)

These connectors are for ATX power supply plugs. The power supply plugs are designed to fit these connectors in only one orientation. Find the proper orientation and push down firmly until the connectors completely fit.

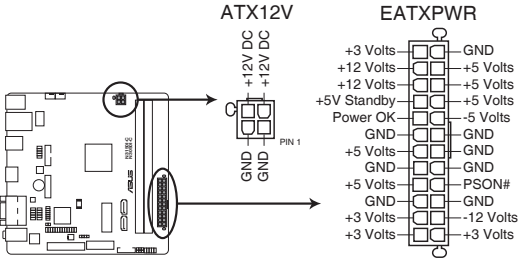

N3150I-C / N3050I-C ATX power connectors



- For a fully configured system, we recommend that you use a power supply unit (PSU) that complies with ATX 12 V Specification 2.0 (or later version) and provides a minimum power of 350 W.
- DO NOT forget to connect the 4-pin ATX +12V power plug. Otherwise, the system will not boot up.
- We recommend that you use a PSU with higher power output when configuring a system with more power-consuming devices. The system may become unstable or may not boot up if the power is inadequate.
- If you are uncertain about the minimum power supply requirement for your system, refer to the Recommended Power Supply Wattage Calculator at <http://support.asus.com/PowerSupplyCalculator/PSCalculator.aspx?SLanguage=en-us> for details.

5. TPM connector (14-1 pin TPM)

This connector supports a Trusted Platform Module (TPM) system, which can securely store keys, digital certificates, passwords and data. A TPM system also helps enhance network security, protects digital identities, and ensures platform integrity.

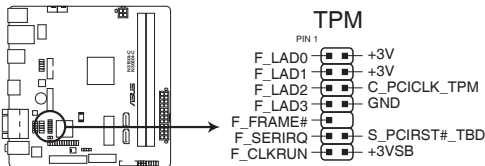

N3150I-C / N3050I-C TPM connector



The TPM module is purchased separately.

6. USB 2.0 connector (10-1 pin USBE34)

This connector is for USB 2.0 ports. Connect the USB module cable to this connector, then install the module to a slot opening at the back of the system chassis. This USB connector complies with USB 2.0 specification that supports up to 480 Mbps connection speed.

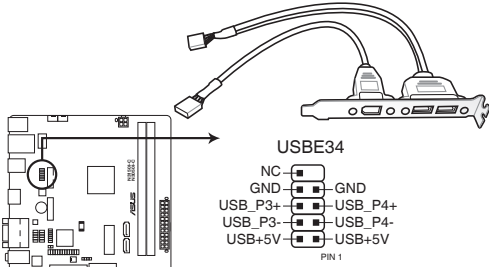

N3150I-C / N3050I-C USB2.0 connector



Never connect a 1394 cable to this USB connector. Doing so will damage the motherboard!



The USB module cable is purchased separately.

7. USB 3.0 connector (20-1 pin USB3_34)

This connector allows you to connect a USB 3.0 module for additional USB 3.0 front or rear panel ports. With an installed USB 3.0 module, you can enjoy all the benefits of USB 3.0 including faster data transfer speeds of up to 5 Gbps, faster charging time for USB-chargeable devices, optimized power efficiency, and backward compatibility with USB 2.0.

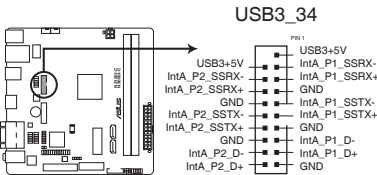

N3150I-C / N3050I-C USB3.0 connector



The USB 3.0 module is purchased separately.

8. System panel connector (10-1 pin F_PANEL)

This connector supports several chassis-mounted functions.

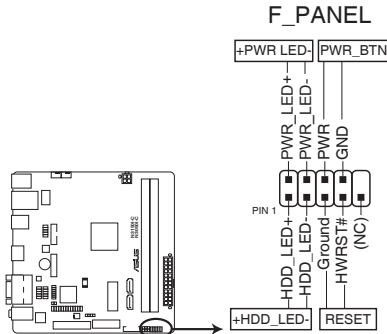

N3150I-C / N3050I-C System panel connector

- **System power LED (2-pin PWRLED)**

This 2-pin connector is for the system power LED. Connect the chassis power LED cable to this connector. The system power LED lights up when you turn on the system power, and blinks when the system is in sleep mode.

- **Hard disk drive activity LED (2-pin +HLED)**

This 2-pin connector is for the HDD Activity LED. Connect the HDD Activity LED cable to this connector. The HD LED lights up or flashes when data is read from or written to the HDD.

- **ATX power button/soft-off button (2-pin PWRBTN)**

This connector is for the system power button.

- **Reset button (2-pin RESET)**

This 2-pin connector is for the chassis-mounted reset button for system reboot without turning off the system power.

9. LVDS connector (40-pin LVDS)

This connector is for an LCD monitor that supports Low-voltage Differential Signaling (LVDS) interface.

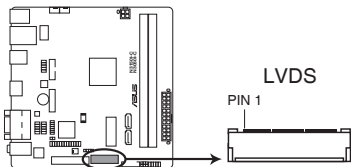

N3150I-C / N3050I-C LVDS connector



The LVDS output is disabled by default. To connect a LVDS monitor, set the **IGD Flat Panel** item in the BIOS setup to [LVDS]. See section **2.5.3 SoC Configuration** for details.

10. Serial ATA 6.0Gb/s connectors (7-pin SATA6G_1/2)

These connectors connect to Serial ATA 6.0 Gb/s hard disk drive or optical drive via Serial ATA 6.0 Gb/s signal cables.

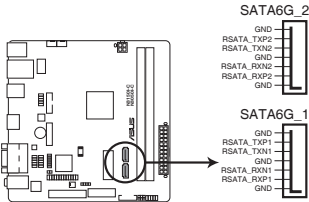

N3150I-C / N3050I-C SATA 6.0Gb/s connectors



- To configure the default SATA type in BIOS, click **Advanced Mode > Advanced tab > SATA Configuration > SATA Mode**.
- When using hot-plug and NCQ, set the **SATA Mode** item in the BIOS to [AHCI]. See section 2.5.4 **SATA Configuration** for details.

11. Flat panel display brightness (8-pin LCD_BLKT_PANEL)

This connector is for the LCD panel brightness controls.

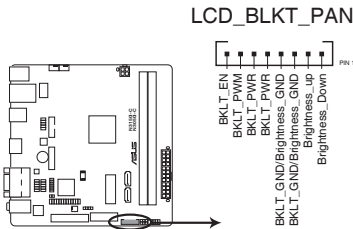

N3150I-C / N3050I-C Flat panel display brightness

12. Display panel power connector (2-pin PANEL_SW)

This connector is used for the display panel power switch.

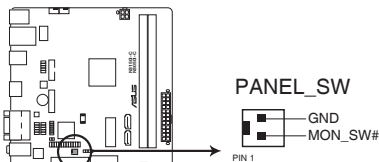

N3150I-C / N3050I-C Display panel power connector

13. Mini PCIe slot

Install a half length mini PCIe module into this mini PCIe slot.

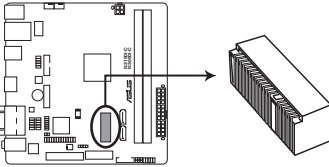

N3150I-C / N3050I-C Mini PCIe slot



The mini PCIe module is purchased separately.

14. LPT connector (26-1 pin LPT)

The LPT (Line Printing Terminal) connector supports devices such as a printer. LPT is standardized as IEEE 1284, which is the parallel port interface on IBM PC-compatible computers.

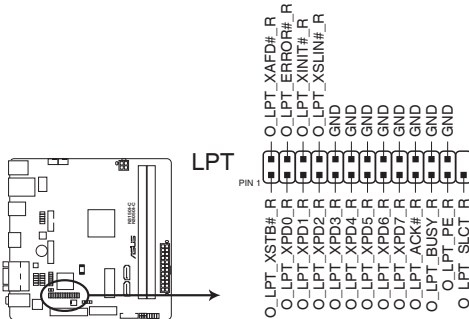

N3150I-C / N3050I-C Parallel port connector

1.8 Software support

1.8.1 Installing an operating system

This motherboard supports Windows® 8.1 64-bit and Windows® 7 64-bit. Always install the latest OS version and corresponding updates to maximize the features of your hardware.



Motherboard settings and hardware options vary. Refer to your OS documentation for detailed information.

1.8.2 Support DVD information

The Support DVD that comes with the motherboard package contains the drivers, software applications, and utilities that you can install to avail all motherboard features.



The contents of the Support DVD are subject to change at any time without notice. Visit the ASUS website at www.asus.com for updates.

To run the Support DVD

Place the Support DVD into the optical drive. If Autorun is enabled in your computer, the DVD automatically displays the Specials screen which contains the unique features of ASUS motherboard. Click Drivers, Utilities, Manual, and Contact tabs to display their respective menus.



The following screen is for reference only.



Click an item to install



If Autorun is NOT enabled in your computer, browse the contents of the Support DVD to locate the file ASSETUP.EXE from the BIN folder. Double-click the ASSETUP.EXE to run the DVD.

1.9 Windows® 7 64-bit and USB 3.0 driver installation

Based on the chipset specification, the Braswell series requires USB 3.0 drivers to be preloaded in order to use USB keyboard/mouse during Windows® 7 64-bit installation. This section is a guide on preloading USB 3.0 drivers and installing Windows® 7 64-bit.

Method 1: Using SATA ODD & USB devices

Load USB 3.0 drivers using the ASUS support DVD and install Windows® 7 64-bit using a USB device.

Requirement:

- 1 x ASUS support DVD
- 1 x Windows® 7 64-bit installation source
- 1 x SATA ODD
- 1 x USB device (ODD or storage)



The USB storage device requires 8 GB or more capacity. It is recommended to format the storage device before use.

1. Insert the Windows® 7 64-bit installation DVD into a USB ODD, or copy all files on the Windows® 7 64-bit installation DVD to a USB storage device on a working system.
2. Connect the USB ODD or USB storage device to your Braswell series platform.
3. Insert the ASUS support DVD into a SATA ODD on your Braswell series platform.
4. Power on your system and press F8 during POST (Power-On Self Test) to enter the boot screen.
5. Select the USB ODD or USB storage device as the boot device.

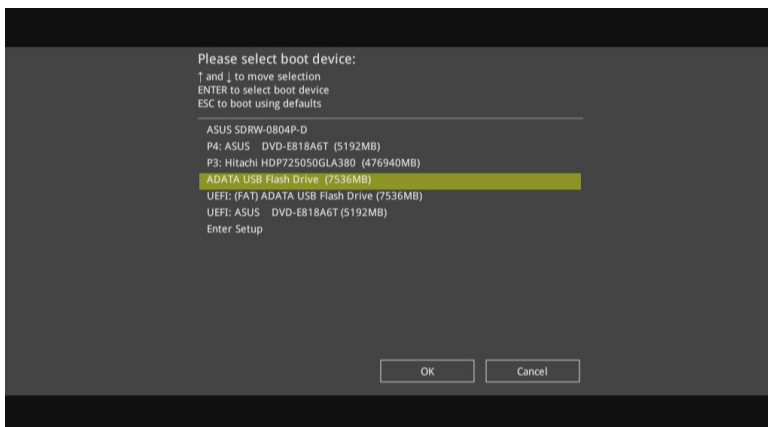

6. The USB 3.0 driver will be loaded automatically during installation startup.

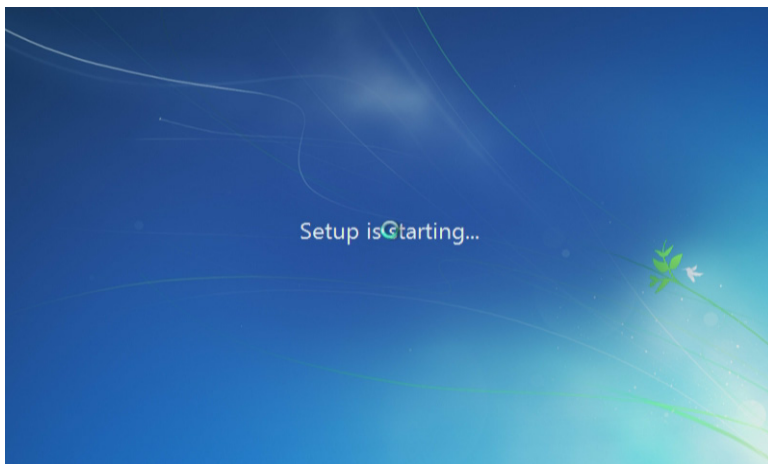

The "Setup is starting..." screen will show up if the USB 3.0 driver is loaded correctly.

7. Follow the onscreen instructions to complete the Windows® 7 64-bit installation.

Method 2: Using a modified Windows® 7 64-bit ISO

Load USB 3.0 drivers and install Windows® 7 64-bit using a modified Windows® 7 64-bit installation DVD.

Requirement:

- 1 x ASUS support DVD
 - 1 x Windows® 7 64-bit installation source
 - 1 x Working system (PC or notebook)
 - 1 x SATA ODD
1. On your working system, create an ISO image file of the Windows® 7 64-bit installation source using a third-party ISO software.
 2. Copy both “Auto_Unattend.xml” and “Auto_Unattend” folder from the root directory of the ASUS supporting DVD to your system.

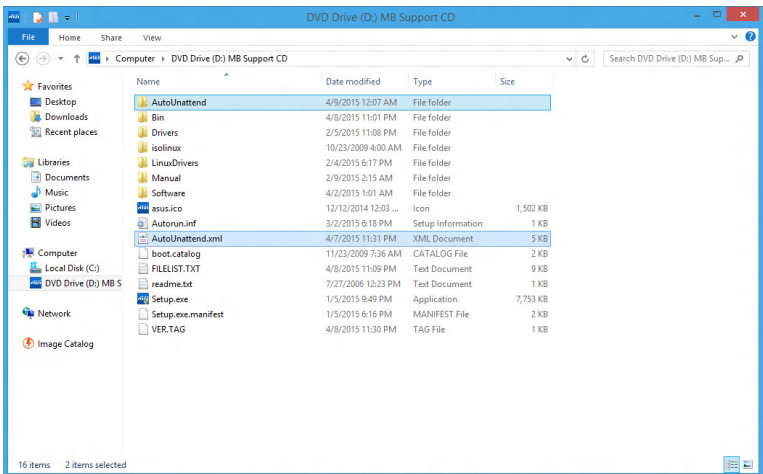

3. Edit the ISO file and add both “Auto_Unattend.xml” and “Auto_Unattend” folder into the ISO file.
4. Burn this ISO file onto an empty DVD to create a modified Windows® 7 64-bit installation DVD.
5. Insert the modified Windows® 7 64-bit installation DVD into an ODD on your Braswell series platform.
6. Power on your system and press F8 during POST (Power-On Self Test) to enter the boot screen.

7. Select the ODD as the boot device.

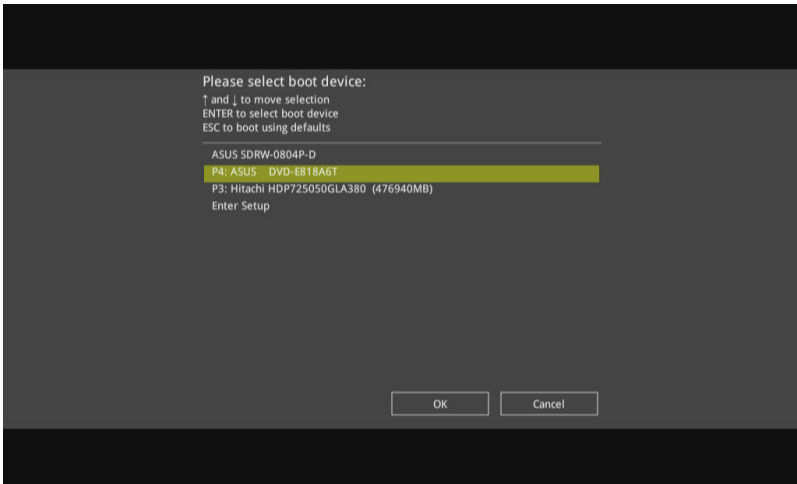

8. The USB 3.0 driver will be loaded automatically during installation startup.

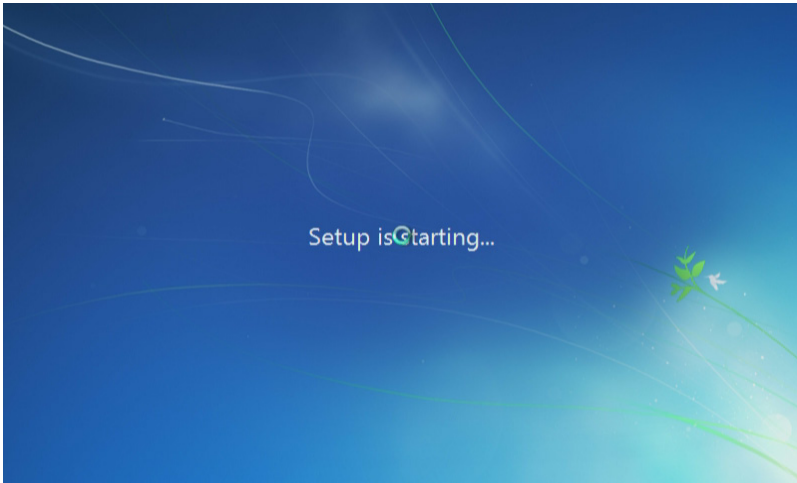

The "Setup is starting..." screen will show up if the USB 3.0 driver is loaded correctly.

9. Follow the onscreen instructions to complete the Windows® 7 64-bit installation.

BIOS information

2

2.1 Managing and updating your BIOS



Save a copy of the original motherboard BIOS file to a USB flash disk in case you need to restore the BIOS in the future. Copy the original motherboard BIOS using the ASUS Update utility.

2.1.1 EZ Update

EZ Update is a utility that allows you to automatically update your motherboard's softwares, drivers and the BIOS version easily. With this utility, you can also manually update the saved BIOS and select a boot logo when the system goes into POST.

To launch EZ Update, click **EZ Update** on the AI Suite 3 main menu bar.

Click to automatically update your motherboard's driver, software and firmware

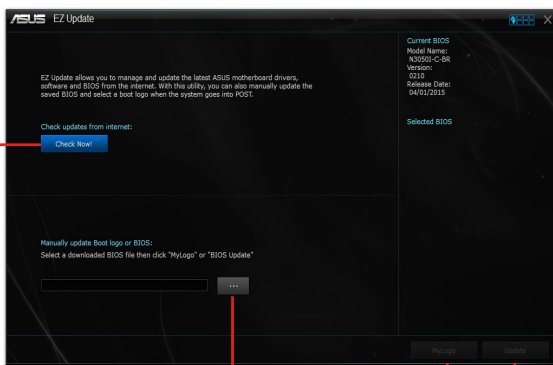

Click to find and select the BIOS from file

Click to select a boot logo

Click to update the BIOS



EZ Update requires an Internet connection either through a network or an ISP (Internet Service Provider).

2.1.2 ASUS EZ Flash 2

The ASUS EZ Flash 2 feature allows you to update the BIOS without using an OS-based utility.



Before you start using this utility, download the latest BIOS file from the ASUS website at www.asus.com.

To update the BIOS using EZ Flash 2:

1. Insert the USB flash disk that contains the latest BIOS file to the USB port.
2. Enter the **Advanced Mode** of the BIOS setup program. Go to the **Tool** menu to select **ASUS EZ Flash 2 Utility** and press <Enter> to enable it.
3. Press the Left/Right arrow keys to switch to the **Drive** field.
4. Press the Up/Down arrow keys to find the USB flash disk that contains the latest BIOS, and then press <Enter>.
5. Press the Left/Right arrow keys to switch to the **Folder Info** field.
6. Press the Up/Down arrow keys to find the BIOS file, and then press <Enter> to perform the BIOS update process. Reboot the system when the update process is done.



- This function supports USB flash disks formatted using FAT32/16 on a single partition only.
- DO NOT shut down or reset the system while updating the BIOS to prevent system boot failure!

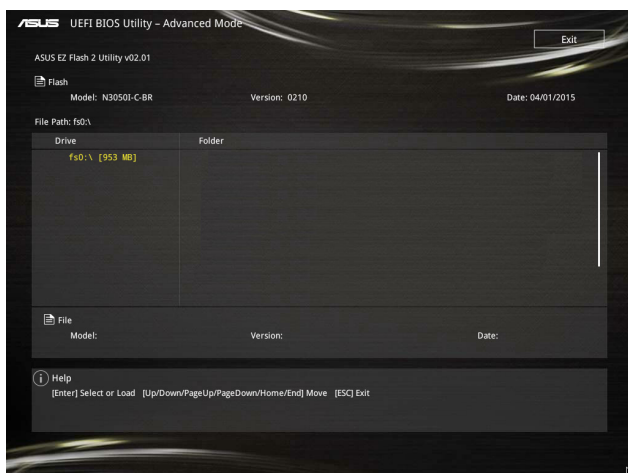

2.1.3 ASUS CrashFree BIOS 3 utility

The ASUS CrashFree BIOS 3 is an auto recovery tool that allows you to restore the BIOS file when it fails or gets corrupted during the updating process. You can restore a corrupted BIOS file using the motherboard support DVD or a USB flash drive that contains the updated BIOS file.



- Before using this utility, rename the BIOS file in the removable device into **N3050IC.CAP**.
- The BIOS file in the support DVD may not be the latest version. Download the latest BIOS file from the ASUS website at www.asus.com.

Recovering the BIOS

To recover the BIOS:

1. Turn on the system.
2. Insert the support DVD to the optical drive or the USB flash drive that contains the BIOS file to the USB port.
3. The utility automatically checks the devices for the BIOS file. When found, the utility reads the BIOS file and enters ASUS EZ Flash 2 utility automatically.
4. The system requires you to enter BIOS Setup to recover BIOS settings. To ensure system compatibility and stability, we recommend that you press <F5> to load default BIOS values.



DO NOT shut down or reset the system while updating the BIOS! Doing so can cause system boot failure!

2.1.4 ASUS BIOS Updater

ASUS BIOS Updater allows you to update the BIOS in DOS environment.



The screen captures used in this section are for reference only and may not be exactly the same as actually shown on your computer screen.

Before updating BIOS

- Prepare the motherboard support DVD and a USB flash drive.
- Download the latest BIOS file and BIOS Updater from <http://support.asus.com> and save them in your USB flash drive.



NTFS is not supported under FreeDOS environment. Ensure that your USB flash drive is in single partition and in FAT32/16 format.

- Turn off the computer.
- Ensure that your computer has a DVD optical drive.

Booting the system in DOS environment

To boot the system in DOS:

1. Insert the USB flash drive with the latest BIOS file and BIOS Updater to the USB port.
2. Boot your computer then press <F8> to launch the select boot device screen.
3. When the select boot device screen appears, insert the Support DVD into the optical drive then select the optical drive as the boot device.

Please select boot device:

↑ and ↓ to move selection
ENTER to select boot device
ESC to boot using defaults

P2: ST3808110AS (76319MB)
aigo miniking (250MB)
UEFI: (FAT) ASUS DRW-2014L1T(4458MB)
P1: ASUS DRW-2014L1T(4458MB)
UEFI: (FAT) aigo miniking (250MB)
Enter Setup

4. When the booting message appears, press <Enter> within five (5) seconds to enter FreeDOS prompt.

```
ISOLINUX 3.20 2006-08-26 Copyright (C) 1994-2005 H. Peter Anvin  
A Bootable DVD/CD is detected. Press ENTER to boot from the DVD/CD.  
If no key is pressed within 5 seconds, the system will boot next priority  
device automatically. boot:
```

5. On the FreeDOS prompt, type **d:** then press <Enter> to switch the disk from Drive C (optical drive) to Drive D (USB flash drive).

```
Welcome to FreeDOS (http://www.freedos.org)!  
C: /> d:  
D: />
```

Updating the BIOS file

To update the BIOS file:

1. On the FreeDOS prompt, type **bupdater /pc /g** and press <Enter>.

```
D: /> bupdater /pc /g
```

2. On the BIOS Updater screen, press <Tab> to switch from Files panel to Drives panel then select **D:**.

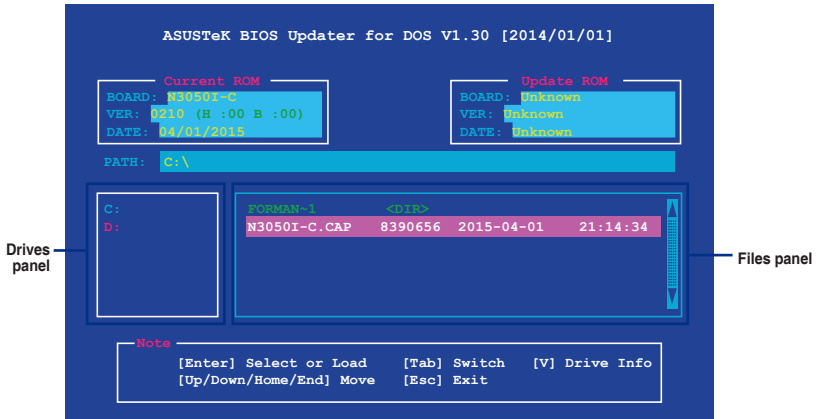

3. Press <Tab> to switch from Drives panel to Files panel then press <Up/Down or Home/End> keys to select the BIOS file and press <Enter>.
4. After the BIOS Updater checks the selected BIOS file, select **Yes** to confirm the BIOS update.



The BIOS Backup feature is not supported due to security regulations.

5. Select **Yes** then press <Enter>. When BIOS update is done, press <ESC> to exit BIOS Updater.
6. Restart your computer.



DO NOT shut down or reset the system while updating the BIOS to prevent system boot failure.



Ensure to load the BIOS default settings to ensure system compatibility and stability. Select the **Load Optimized Defaults** item under the **Exit BIOS** menu. See section 2.9 **Exit Menu** for details.

2.2 BIOS setup program

Use the BIOS Setup program to update the BIOS or configure its parameters. The BIOS screens include navigation keys and brief online help to guide you in using the BIOS Setup program.

Entering BIOS Setup at startup

To enter BIOS Setup at startup:

Press <Delete> or <F2> during the Power-On Self Test (POST). If you do not press <Delete> or <F2>, POST continues with its routines.

Entering BIOS Setup after POST

To enter BIOS Setup after POST:

Press <Ctrl>+<Alt>+ simultaneously.

Press the reset button on the system chassis.

Press the power button to turn the system off then back on. Do this option only if you failed to enter BIOS Setup using the first two options.



Using the power button, reset button, or the <Ctrl>+<Alt>+ keys to force reset from a running operating system can cause damage to your data or system. We recommend you always shut down the system properly from the operating system.



- The BIOS setup screens shown in this section are for reference purposes only, and may not exactly match what you see on your screen.
 - Visit the ASUS website at www.asus.com to download the latest BIOS file for this motherboard.
 - Ensure that a USB mouse is connected to your motherboard if you want to use the mouse to control the BIOS setup program.
 - If the system becomes unstable after changing any BIOS setting, load the default settings to ensure system compatibility and stability. Select the **Load Optimized Defaults** item under the Exit menu or press hotkey F5. See section 2.9 Exit Menu for details.
 - If the system fails to boot after changing any BIOS setting, try to clear the CMOS and reset the motherboard to the default value. See section 1.6 Headers for information on how to erase the RTC RAM.
-

BIOS menu screen

The BIOS setup program can be used under two modes: **EZ Mode** and **Advanced Mode**. Press <F7> to change between the two modes.

2.2.1 EZ Mode

By default, the EZ Mode screen appears when you enter the BIOS setup program. The EZ Mode provides you an overview of the basic system information, and allows you to select the display language, system performance mode, fan profile and boot device priority. To access the Advanced Mode, click **Advanced Mode(F7)** or press <F7>.



The default screen for entering the BIOS setup program can be changed. Refer to the **Setup Mode** item in section 2.7 **Boot menu** for details.

Displays the CPU/motherboard temperature, CPU voltage output, CPU/chassis fan speed, and SATA information

Selects the display language of the BIOS setup program

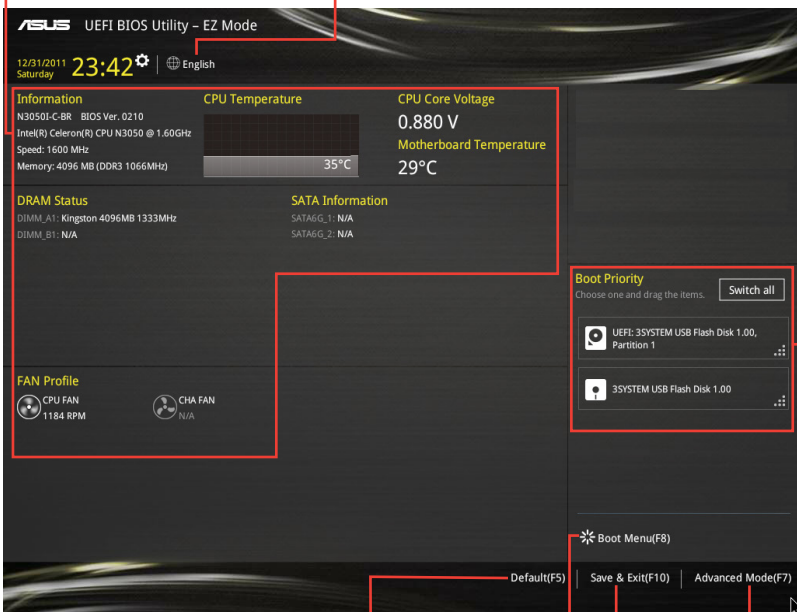

Loads optimized default settings

Saves the changes and resets the system

Shows the bootable devices

Displays the Advanced mode menus

Selects the boot device priority



The boot device options vary depending on the devices you installed to the system.

2.2.2 Advanced Mode

The Advanced Mode provides advanced options for experienced end-users to configure the BIOS settings. The figure below shows an example of the **Advanced Mode**. Refer to the following sections for the detailed configurations.



To access the EZ Mode, click **EzMode(F7)** or press <F7>.

The screenshot shows the ASUS UEFI BIOS Utility in Advanced Mode. The interface includes a menu bar at the top with options: My Favorites, Main, **Advanced**, Monitor, Boot, Tool, and Exit. A sub-menu item 'PPM Configuration' is expanded to show 'PPM Configuration Parameters'. On the right, there is a 'Hardware Monitor' section displaying CPU and Memory status. At the bottom, there are fields for 'Last Modified' and 'EzMode(F7)'. Red lines and boxes highlight specific features, which are labeled as follows:

- Quick Note**: Points to the top utility bar.
- MyFavorite**: Points to the 'My Favorites' menu item.
- Language**: Points to the language selection icon.
- Hot Keys**: Points to the 'Hot Keys' menu item.
- Menu bar**: Points to the top navigation bar.
- Sub-menu item**: Points to 'PPM Configuration'.
- Menu items**: Points to the 'PPM Configuration Parameters' list.
- General help**: Points to the information icon (i) next to the sub-menu.
- Configuration fields**: Points to the 'Limit CPUID Maximum', 'Bi-directional PROCHOT', and 'Intel Virtualization Technology' settings.
- Scroll bar**: Points to the vertical scrollbar on the right side of the configuration list.
- Last modified settings**: Points to the 'Last Modified' field at the bottom.
- Goes back to EZ Mode**: Points to the 'EzMode(F7)' button.
- Displays the CPU/motherboard temperature, CPU and memory voltage output**: Points to the 'Hardware Monitor' section.

Menu bar

The menu bar on top of the screen has the following main items:

My Favorites	For saving the frequently-used system settings and configuration
Main	For changing the basic system configuration
Advanced	For changing the advanced system settings
Monitor	For displaying the system temperature, power status, and changing the fan settings
Boot	For changing the system boot configuration
Tool	For configuring options for special functions
Exit	For selecting the exit options and loading default settings

Menu items

The highlighted item on the menu bar displays the specific items for that menu. For example, selecting **Main** shows the Main menu items.

The other items (My Favorites, Advanced, Monitor, Boot, Tool, and Exit) on the menu bar have their respective menu items.

Submenu items

A greater than sign (>) before each item on any menu screen means that the item has a submenu. To display the submenu, select the item and press <Enter>.

Language

This button above the menu bar contains the languages that you can select for your BIOS. Click this button to select the language that you want to display in your BIOS screen.

MyFavorites (F3)

This button above the menu bar shows all BIOS items in a Tree Map setup. Select frequently-used BIOS settings and save it to MyFavorites menu.



Refer to section **2.3 My Favorites** for more information.

Quick Note (F9)

This button above the menu bar allows you to key in notes of the activities that you have done in BIOS.



- The Quick Note function does not support the following keyboard functions: delete, cut, copy and paste.
 - You can only use the alphanumeric characters to enter your notes.
-

Hot keys

This button above the menu bar contains the navigation keys for the BIOS setup program. Use the navigation keys to select items in the menu and change the settings.

Scroll bar

A scroll bar appears on the right side of a menu screen when there are items that do not fit on the screen. Press the Up/Down arrow keys or <Page Up> / <Page Down> keys to display the other items on the screen.

General help

At the top right corner of the menu screen is a brief description of the selected item. Use <F12> key to capture the BIOS screen and save it to the removable storage device.

Configuration fields

These fields show the values for the menu items. If an item is user-configurable, you can change the value of the field opposite the item. You cannot select an item that is not user-configurable.

A configurable field is highlighted when selected. To change the value of a field, select it and press <Enter> to display a list of options.

Last Modified button

This button shows the items that you last modified and saved in BIOS Setup.

2.3 My Favorites

MyFavorites is your personal space where you can easily save and access your favorite BIOS items.

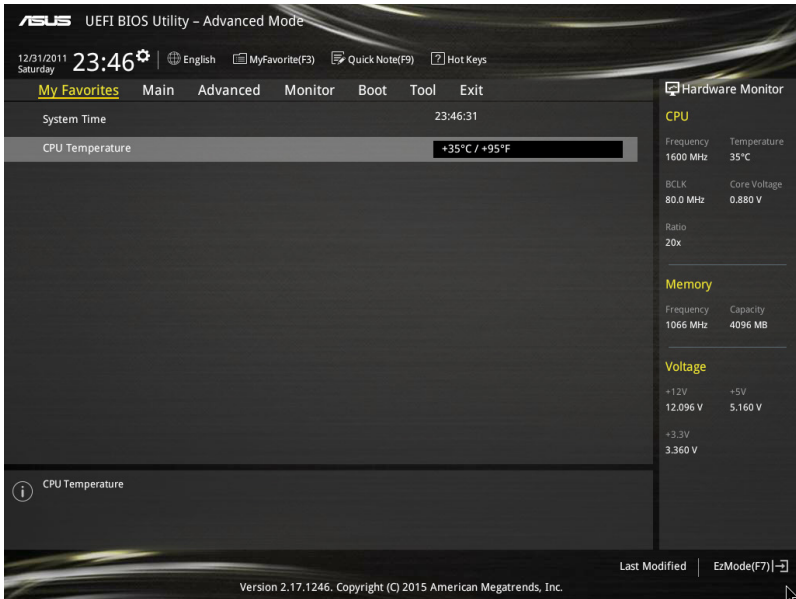

Adding items to My Favorites

To add BIOS items:

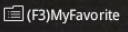
1. Press <F3> on your keyboard or click  from the BIOS screen to open Setup Tree Map screen.
2. On the Setup Tree Map screen, select the BIOS items that you want to save in MyFavorites screen.

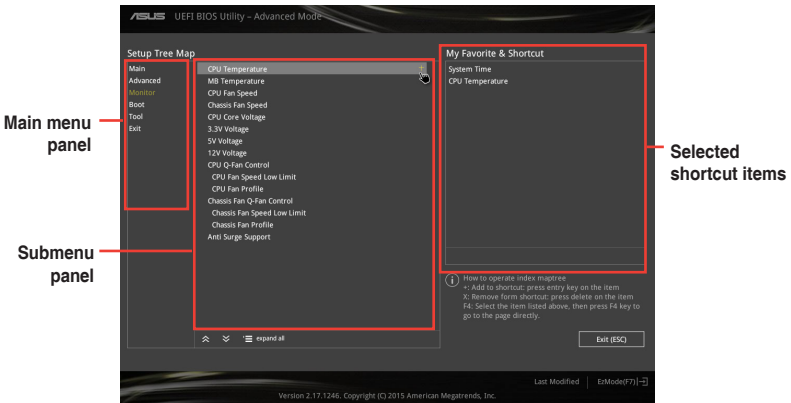

3. Select an item from main menu panel, then click the submenu that you want to save as favorite from the submenu panel and click .



You cannot add the following items to My Favorite items:

- User-managed items such as language and boot order
 - Configuration items such as Memory SPD Information, system time and date.
4. Click **Exit (ESC)** or press <esc> key to close Setup Tree Map screen.
 5. Go to My Favorites menu to view the saved BIOS items.

2.4 Main menu

The Main menu screen appears when you enter the Advanced Mode of the BIOS Setup program. The Main menu provides you an overview of the basic system information, and allows you to set the system date, time, language, and security settings.



2.4.1 Language [English]

Allows you to choose the BIOS language version from the options. Configuration options: [English] [Français] [Deutsch] [简体中文] [繁體中文] [日本語] [Español] [Русский] [한국어]

2.4.2 Security

The Security menu items allow you to change the system security settings.



- If you have forgotten your BIOS password, erase the CMOS Real Time Clock (RTC) RAM to clear the BIOS password. See section 1.6 Headers for information on how to erase the RTC RAM.
- The **Administrator** or **User Password** items on top of the screen show the default **Not Installed**. After you set a password, these items show **Installed**.

Administrator Password

If you have set an administrator password, we recommend that you enter the administrator password for accessing the system. Otherwise, you might be able to see or change only selected fields in the BIOS setup program.

To set an administrator password:

1. Select the **Administrator Password** item and press <Enter>.
2. From the **Create New Password** box, key in a password, then press <Enter>.
3. Confirm the password when prompted.

To change an administrator password:

1. Select the **Administrator Password** item and press <Enter>.
2. From the **Enter Current Password** box, key in the current password, then press <Enter>.
3. From the **Create New Password** box, key in a new password, then press <Enter>.
4. Confirm the password when prompted.

To clear the administrator password, follow the same steps as in changing an administrator password, but press <Enter> when prompted to create/confirm the password. After you clear the password, the **Administrator Password** item on top of the screen shows **Not Installed**.

User Password

If you have set a user password, you must enter the user password for accessing the system. The **User Password** item on top of the screen shows the default **Not Installed**. After you set a password, this item shows **Installed**.

To set a user password:

1. Select the **User Password** item and press <Enter>.
2. From the **Create New Password** box, key in a password, then press <Enter>.
3. Confirm the password when prompted.

To change a user password:

1. Select the **User Password** item and press <Enter>.
2. From the **Enter Current Password** box, key in the current password, then press <Enter>.
3. From the **Create New Password** box, key in a new password, then press <Enter>.
4. Confirm the password when prompted.

To clear the user password, follow the same steps as in changing a user password, but press <Enter> when prompted to create/confirm the password. After you clear the password, the **User Password** item on top of the screen shows **Not Installed**.

2.5 Advanced menu

The Advanced menu items allow you to change the settings for the CPU and other system devices.



Be cautious when changing the settings of the Advanced menu items. Incorrect field values can cause the system to malfunction.

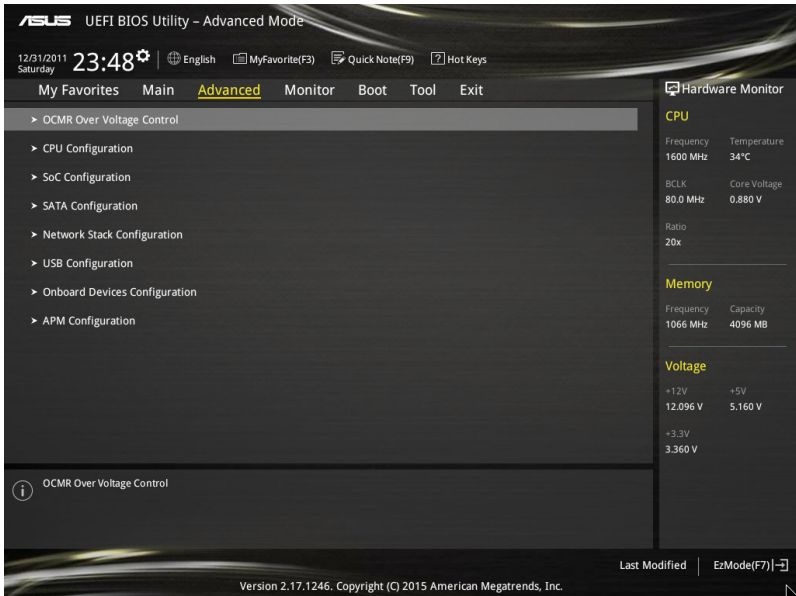

2.5.1 OCMR Over Voltage Control

DRAM Over Voltage [Auto]

Allows you to set the DRAM Over Voltage. Configuration options: [Auto] [1.35V] [1.5V] [1.55V] [1.65V]

2.5.2 CPU Configuration

The items in this menu show the CPU-related information that the BIOS automatically detects.

Limit CPUID Maximum [Disabled]

When set to [Enabled], this item allows the legacy OS to boot even without support for CPUs with extended CPUID functions. Configuration options: [Disabled] [Enabled]

Intel Virtualization Technology [Enabled]

When set to [Enabled], a VMM can utilize the additional hardware capabilities provided by Vanderpool Technology. Configuration options: [Disabled] [Enabled]

PPM Configuration

This item allows you to manage and configure the CPU's power.

EIST [Enabled]

Allows you to enable or disable Enhanced Intel® SpeedStep Technology (EIST).
[Disabled] The CPU runs at its default speed.

[Enabled] The operating system controls the CPU speed.

Turbo Mode [Enabled]

This item allows you to automatically set the CPU cores to run faster than the base operating frequency when it is below the operating power, current and temperature specification limit. Configuration options: [Enabled] [Disabled]

CPU C state Report [Auto]

This item allows you to set the power saving of the CPU states. Configuration options: [Auto] [Disabled] [Enabled]



The following item appears only when you set the CPU C state Report item to **[Enabled]** or **[Disabled]**.

Max CPU C-state [C7]

This item allows you to set the maximum C-state that the processor supports.
Configuration options: [C7] [C6] [C1]

2.5.3 SoC Configuration

Intel IGD Configuration

IGD Turbo [Auto]

Allows you to enable/disable IGD Turbo. Configuration options: [Auto] [Enabled] [Disabled]

Primary Display [Auto]

Select which IGD/PCI Graphics device should be used as Primary Display.
Configuration options: [Auto] [IGD] [PCIe]

iGPU Memory [64M]

Allows you to select the amount of system memory allocated to DVMT 5.0 used by the iGPU. Configuration options: [32M] [64M] [96M] [128M] ~ [480M] [512M]

LVDS Configuration

IGD Flat Panel [Disabled]

Allows you to enable or disable IGD video output to onboard LVDS. Configuration options: [Disabled] [LVDS]

All-in-One Chassis [None]

Set up this item for simplified Aio configuration. Configuration options: [None] [ECS (21.5x22)] [Mitac Maestro (21.5x22)] [Gigabyte (18.5x22)] [LP-215x (21.5x22)] [Wibtek A21 (21.5x22)] [Wibtek A23 (23.6x22)] [Jumper Sail (21.5x22)] [Pixxo HP-A206D (21.5x22)] [22AM33NB (21.5x22)] [3N0D (21.5x22)]

Pre-Defined LVDS Panel Type [Auto]

Allows you to configure the LVDS panel used by Internal Graphics Device.
Configuration options: [Auto] [640x480] [800x600] [1024x768] [1280x1024]
[1400x1050(RB) LVDS1] [1400x1050 LVDS2] [1600x1200 LVDS] [1366x768 LVDS]
[1680x1050] [1920x1200] [1440x900 LVDS] [1600x900 LVDS] [1024x768 LVDS2]
[1280x800] [1920x1080 LVDS]

EDID Data Source [Flat Panel Display]

Configuration options: [Pre-defined] [Flat Panel Display]

Screen Brightness [Neutral]

Allows you to set the display brightness. Configuration options: [Dimmest] [Dimmer]
[Dim] [Neutral] [Bright] [Brighter] [Brightest]

Channel Select [Single Channel]

Configuration options: [Dual Channel] [Single Channel]

Mode Select [8bit Mode(JEIDA)]

Configuration options: [8bit Mode(JEIDA)] [8bit Mode(VESA)] [6bit Mode(VESA and
JEIDA)]

Panel Power Sequence Control [Enabled]

Configuration options: [Enabled] [Disabled]

Panel_Vcc ON to Video_Data ON (T8) [20 ms]

Configuration options: [10 ms] [20 ms] [30 ms] [40 ms]

Video_Data ON to BKLT_PWM ON (T9) [250 ms]

Configuration options: [100 ms] [200 ms] [250 ms] [300 ms]

BKLT_PWM ON to BKLT_Enable ON (T10) [15 ms]

Configuration options: [10 ms] [15 ms] [20 ms] [25 ms]

BKLT_Enable OFF to BKLT_PWM OFF (T11) [10 ms]

Configuration options: [5 ms] [10 ms] [15 ms] [20 ms]

BKLT_PWM OFF to Video_Data OFF (T12) [250 ms]

Configuration options: [100 ms] [200 ms] [250 ms] [300 ms]

Video_Data OFF to Panel_Vcc OFF (T13) [20 ms]

Configuration options: [10 ms] [20 ms] [30 ms] [40 ms]

Min Panel_Vcc OFF Time (T15) [600 ms]

Configuration options: [600 ms] [700 ms] [800 ms] [1000 ms]

LVDS Spread Spectrum Control [+/- 0.5% Center Spread]

Configuration options: [Disabled] [+/- 0.5% Center Spread] [+/- 1% Center Spread]

2.5.4 SATA Configuration

While entering Setup, the BIOS automatically detects the presence of SATA devices. The SATA Port items show Empty if no SATA device is installed to the corresponding SATA port.

SATA Controller [Enabled]

Allows you to enable/disable the SATA controller. Configuration options: [Disabled] [Enabled]

SATA Mode Selection [AHCI]

Allows you to set the SATA configuration.

[AHCI] Set to [AHCI] when you want the SATA hard disk drives to use the AHCI (Advanced Host Controller Interface). The AHCI allows the onboard storage driver to enable advanced Serial ATA features that increases storage performance on random workloads by allowing the drive to internally optimize the order of commands.

Aggressive LPM Support [Disabled]

This item is designed for LPM (link power management) support with a better energy saving conditions. When disabled, the hot plug function of SATA ports are disabled. Configuration options: [Disabled] [Enabled]

S.M.A.R.T. Status Check [On]

S.M.A.R.T. (Self-Monitoring, Analysis and Reporting Technology) is a monitoring system that shows a warning message during POST (Power-on Self Test) when an error occurs in the hard disks. Configuration options: [On] [Off]

Hot Plug [Disabled] (SATA6G_1, SATA6G_2)

These items allow you to enable/disable SATA Hot Plug Support. Configuration options: [Disabled] [Enabled]

2.5.5 Network Stack Configuration

Network Stack [Disabled]

This item allows user to disable or enable the UEFI network stack. Configuration options: [Disabled] [Enabled]



The following two items appear only when you set the previous item to [Enabled].

Ipv4 / Ipv6 PXE Support [Enabled]

This item allows you to enable or disable the Ipv4/Ipv6 PXE wake event. Configuration options: [Disabled] [Enabled]

2.5.6 USB Configuration

The items in this menu allow you to change the USB-related features.



The **USB Devices** item shows the auto-detected values. If no USB device is detected, the item shows None.

xHCI Hand-off [Enabled]

[Enabled] Support xHCI by BIOS for operating systems without xHCI support.

[Disabled] Support xHCI by xHCI drivers for operating systems with xHCI support.

Mass Storage Devices [Auto]

This item allows your system to detect the devices according to their media formats.

Configuration options: [Auto] [Floppy] [Forced FDD] [Hard Disk] [CD-ROM]

USB Single Port Control

This item allows you to enable or disable the individual USB ports.



Refer to section 1.2.3 **Motherboard layout** for the location of the USB ports.

2.5.7 Onboard Devices Configuration

HD Audio Controller [Enabled]

This item allows you to use the Azalia High Definition Audio Controller. Configuration options: [Disabled] [Enabled]



The following item appears only when you set the HD Audio Controller item to **[Enabled]**.

Front Panel Type [HD Audio]

Allows you to set the front panel audio connector (AAFP) mode to legacy AC'97 or high-definition audio depending on the audio standard that the front panel audio module supports.

[HD Audio] Sets the front panel audio connector (AAFP) mode to high definition audio.

[AC97] Sets the front panel audio connector (AAFP) mode to legacy AC'97.

Realtek LAN Controller [On]

[On] Enables the Realtek LAN controller.

[Off] Disables the controller.

Realtek PXE OPROM [Off]

This item appears only when you set the **Realtek LAN Controller** item to [Enabled] and allows you to enable or disable the Rom of the Realtek LAN controller. Configuration options: [On] [Off]

Power Loading [Auto]

Enables or disables dummy load. When the power supply is at low load, a self-protection will activate causing it to shutdown or fail. If this occurs, please set this item to Enabled. Configuration options: [Auto] [Enabled] [Disabled]

Serial Port 1/2 Configuration

The sub-items in this menu allow you to set the serial port configuration.

Serial Port [On]

Allows you to enable or disable the serial port (COM) 1/2. Configuration options: [On] [Off]

Change Settings [IO=3F8h; IRQ=4]

This item appears only when you set the **Serial Port** to [Enabled] and allows you to select the Serial Port base address. Configuration options: [IO=3F8h; IRQ=4] [IO=2F8h; IRQ=3] [IO=3E8h; IRQ=4] [IO=2E8h; IRQ=3]

Parallel Port Configuration

The sub-items in this menu allow you to set the parallel port configuration.

Parallel Port [On]

Allows you to enable or disable the parallel port (LPT/LPTE).

Configuration options: [On] [Off]



The following items appear only when you set the **Parallel Port Configuration** item to [On].

Change Settings [Auto]

Allows you to select an optimal setting for Super I/O devices. Configuration options: [Auto] [IO=378h; IRQ=5;] [IO=378h; IRQ=5,6,7,9,10,11,12;] [IO=278h; IRQ=5,6,7,9,10,11,12;] [IO=3BCh; IRQ=5,6,7,9,10,11,12;]

Device Mode [STD Printer Mode]

Allows you to select the Printer Port mode. Configuration options: [STD Printer Mode] [SPP Mode] [EPP-1.9 and SPP Mode] [EPP-1.7 and SPP Mode] [ECP Mode] [ECP and EPP 1.9 Mode] [ECP and EPP 1.7 Mode]

2.5.8 APM

Deep S4 [Disabled]

When enabled, the system in S4 state will further reduce power usage and will power off the USB and PS/2 devices. The system in deep S4 state can only be woken up via the power button, devices in LAN, or other ways except via the USB and PS/2 devices. Configuration options: [Disabled] [Enabled]

Restore AC Power Loss [Power Off]

- [Power On] The system goes into on state after an AC power loss.
- [Power Off] The system goes into off state after an AC power loss.
- [Last State] The system goes into either off or on state, whatever the system state was before the AC power loss.

Power On By PS/2 Keyboard [Disabled]

- [Disabled] Disables the Power On by a PS/2 keyboard.
- [Space Bar] Sets the Space Bar on the PS/2 keyboard to turn on the system.
- [Ctrl-Esc] Sets the Ctrl+Esc key on the PS/2 keyboard to turn on the system.
- [Power Key] Sets Power key on the PS/2 keyboard to turn on the system. This feature requires an ATX power supply that provides at least 1A on the +5VSB lead.

Power On By PS/2 Mouse [Disabled]

- [Disabled] Disables the Power On by a PS/2 mouse.
- [Enabled] Enables the Power On by a PS/2 mouse. This feature requires an ATX power supply that provides at least 1A on the +5VSB lead.

Power On By PCI-E [Disabled]

This item allows you to enable or disable the Wake-on-LAN function of the onboard LAN controller or other installed PCIe LAN cards. Configuration options: [Disabled] [Enabled]

Power On By Ring [Disabled]

[Disabled] Disables Ring to generate a wake event.

[Enabled] Enables Ring to generate a wake event.

Power On By RTC [Disabled]

This item allows you to enable or disable the RTC (Real-Time Clock) to generate a wake event and configure the RTC alarm date. When enabled, you can set the days, hours, minutes, or seconds to schedule an RTC alarm date. Configuration options: [Disabled]
[Enabled]

2.6 Monitor menu

The Monitor menu displays the system temperature/power status, and allows you to change the fan settings.

Scroll down to display the other BIOS items.



2.6.1 CPU/ MB Temperature [xxx°C/xxx°F]/ [Ignore]

The onboard hardware monitor automatically detects and displays the CPU and motherboard temperatures. Select [Ignore] if you do not wish to display the detected temperatures.

2.6.2 CPU Fan/ Chassis Fan Speed [xxxx RPM]/ [Ignore]/ [N/A]

The onboard hardware monitor automatically detects and displays the CPU and chassis fan speeds in rotations per minute (RPM). If the fan is not connected to the motherboard, the field shows N/A. Select [Ignore] if you do not wish to display the detected speed.

2.6.3 CPU Core Voltage, 3.3V Voltage, 5V Voltage, 12V Voltage

The onboard hardware monitor automatically detects the voltage output through the onboard voltage regulators. Select **[Ignore]** if you do not want to detect this item.

2.6.4 CPU Q-Fan Control [Auto]

CPU Q-Fan Control [Enabled]

[Disabled] Disables the CPU Q-Fan control feature.

[Enabled] Enables the CPU Q-Fan control feature.

CPU Fan Speed Lower Limit [200 RPM]

This item appears only when you enable the CPU Q-Fan Control feature and allows you to disable or set the CPU fan warning speed. Configuration options: [Ignore] [100RPM] [200RPM] [300 RPM] [400 RPM] [500 RPM]

CPU Fan Profile [Standard]

This item appears only when you enable the CPU Q-Fan Control feature and allows you to set the appropriate performance level of the CPU fan.

[Standard] Sets to [Standard] to make the CPU fan automatically adjust depending on the CPU temperature.

[Silent] Sets to [Silent] to minimize the fan speed for quiet CPU fan operation.

[Turbo] Sets to [Turbo] to achieve maximum CPU fan speed.

[Manual] Sets to [Manual] to assign detailed fan speed control parameters.



The following four items appear only when you set **CPU Fan Profile** to [Manual].

CPU Upper Temperature [70]

Use the <+> and <-> keys to adjust the upper limit of the CPU temperature. The values range from 20°C to 75°C.

CPU Fan Max. Duty Cycle(%) [100]

Use the <+> and <-> keys to adjust the maximum CPU fan duty cycle. The values range from 20% to 100%. When the CPU temperature reaches the upper limit, the CPU fan will operate at the maximum duty cycle.

CPU Lower Temperature [20]

Use the <+> and <-> keys to adjust the lower limit of the CPU temperature. The values range from 20°C to 75°C.

CPU Fan Min. Duty Cycle(%) [20]

Use the <+> and <-> keys to adjust the minimum CPU fan duty cycle. The values range from 20% to 100%. When the CPU temperature is under the lower limit, the CPU fan will operate at the minimum duty cycle.

2.6.5 Chassis Fan Q-Fan Control [Enabled]

[Disabled] Disables the Chassis Q-Fan control feature.

[Enabled] Enables the Chassis Q-Fan control feature.

Chassis Fan Speed Low Limit [600 RPM]

This item appears only when you enable the Chassis Q-Fan Control feature and allows you to disable or set the Chassis fan warning speed. Configuration options: [Ignore] [200 RPM] [300 RPM] [400 RPM] [500 RPM] [600 RPM]

Chassis Fan Profile [Standard]

This item appears only when you enable the Chassis Q-Fan Control feature and allows you to set the appropriate performance level of the Chassis fan.

[Standard] Sets to [Standard] to make the Chassis fan automatically adjust depending on the Chassis temperature.

[Silent] Sets to [Silent] to minimize the fan speed for quiet Chassis fan operation.

[Turbo] Sets to [Turbo] to achieve maximum Chassis fan speed.

[Manual] Sets to [Manual] to assign detailed fan speed control parameters.



The following four items appear only when you set **Chassis Fan Profile** to [Manual].

Chassis Fan Upper Temperature [70]

Use the <+> and <-> keys to adjust the upper limit of the Chassis temperature. The values range from 20°C to 75°C.

Chassis Fan Max. Duty Cycle(%) [100]

Use the <+> and <-> keys to adjust the maximum Chassis fan duty cycle. The values range from 20% to 100%. When the Chassis temperature reaches the upper limit, the Chassis fan will operate at the maximum duty cycle.

Chassis Fan Lower Temperature [20]

Displays the lower limit of the Chassis temperature.

Chassis Fan Min. Duty Cycle(%) [20]

Use the <+> and <-> keys to adjust the minimum Chassis fan duty cycle. The values range from 20% to 100%. When the Chassis temperature is under 40°C, the Chassis fan will operate at the minimum duty cycle.

2.6.6 Anti Surge Support [Off]

This item allows you to enable or disable the Anti Surge function. Configuration options: [On] [Off]

2.7 Boot menu

The Boot menu items allow you to change the system boot options.

Scroll down to display the other BIOS items.

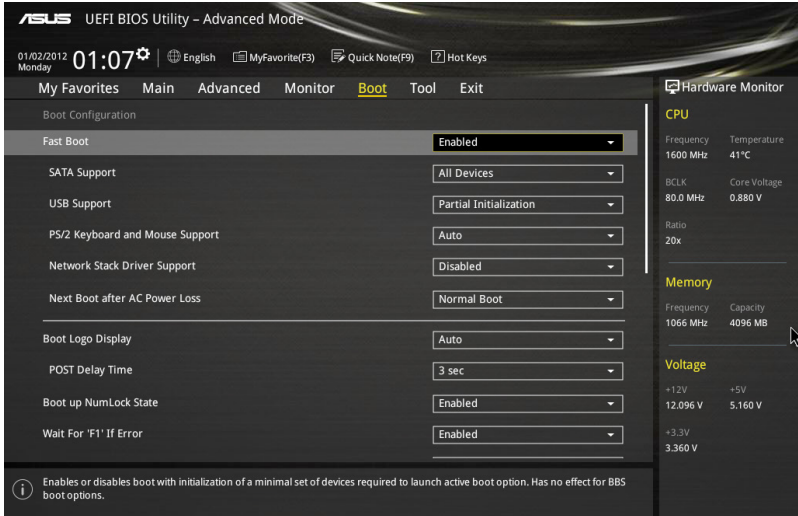

2.7.1 Fast Boot [Enabled]

[Enabled] Select to accelerate the boot speed.

[Disabled] Select to go back to normal boot speed.

SATA Support [All Devices]

[All Devices] All devices connected to SATA ports are available during POST. This process extends the POST time.

[Boot Drive Only] Only boot drives connected to a SATA ports are detected during POST.

USB Support [Partial Initialization]

[Disabled] All USB devices will not be available until OS boot up for a fastest POST time.

[Full Initialization] All USB devices will be available during POST. This process will extend the POST time.

[Partial Initialization] For a faster POST time, only the USB ports with keyboard and mouse connections will be detected.

PS/2 Keyboard and Mouse Support [Auto]

Select any of these settings when PS/2 keyboard and mouse are installed. These settings only apply when Fast Boot is enabled.

[Auto] For a faster POST time, PS/2 devices will only be available when the system boots up or rebooted when the PS/2 devices have not been reconnected or changed. If you disconnect or change PS/2 devices before restarting the system, PS/2 devices will not be available and BIOS setup program will not be accessible via PS/2 devices.

[Full Initialization] For full system control, PS/2 devices will be available during POST at any circumstances. This process will extend POST time.

[Disabled] For the fastest POST time, all PS/2 devices will not be available until your computer enters the operating system.

Network Stack Driver Support [Disabled]

[Disabled] Select to skip the network stack driver from loading during POST.

[Enabled] Select to load the network stack driver during POST.

Next Boot after AC Power Loss [Normal Boot]

[Normal Boot] Returns to normal boot on the next boot after AC power loss.

[Fast Boot] Accelerates the boot speed on the next boot after AC power loss.

2.7.2 Boot Logo Display [Auto]

[Auto] Adjusts logo automatically based on Windows® display requirements.

[Full Screen] Maximize the boot logo size.

[Disabled] Hide the logo during POST.

POST Delay Time [3 sec]

This item appears only when you set Boot Logo Display to [Auto] and [Full Screen]. This item allows you to select the desired additional POST waiting time to easily enter the BIOS setup. You can only execute the POST delay time during Normal Boot. The values range from 0 to 10 seconds.



This feature will only work under normal boot.

Post Report [5 sec]

This item appears only when you set Boot Logo Display to [Disabled]. This item allows you to select a desired post report waiting time. Configuration options: [1 sec] ~ [10 sec] [Until Press ESC].

2.7.3 Bootup NumLock State [Enabled]

This item allows you to enable or disable power-on state of the NumLock. Configuration options: [Disabled] [Enabled]

2.7.4 Wait for 'F1' If Error [Enabled]

When this item is set to [Enabled], the system waits for the F1 key to be pressed when error occurs. Configuration options: [Disabled] [Enabled]

2.7.5 Option ROM Messages [Enabled]

- [Enabled] The third-party ROM messages will be displayed during POST.
- [Disabled] Disables the ROM messages and displays only the ASUS logo during POST.

2.7.6 INT19 Trap Response [Immediate]

This item allows you to trap Interrupt 19 by the option ROMs. Configuration options: [Immediate] [Postponed]

2.7.7 Above 4G Decoding [Disabled]

This item allows you to decode the 64-bit capable devices above 4G address space. Ensure that your system supports 64-bit PCI decoding. Configuration options: [Disabled] [Enabled]

2.7.8 Setup Mode [EZ Mode]

- [Advanced Mode] This item allows you to go to Advanced Mode of the BIOS after POST.
- [EZ Mode] This item allows you to go to EZ Mode of the BIOS after POST.

2.7.9 CSM (Compatibility Support Module)

Allows you to configure the CSM (Compatibility Support Module) items to fully support the various VGA, bootable devices and add-on devices for better compatibility.

Launch CSM [Enabled]

- [Auto] The system automatically detects the bootable devices and the add-on devices.
- [Enabled] For better compatibility, enable the CSM to fully support the non-UEFI driver add-on devices or the Windows® UEFI mode.
- [Disabled] Disable the CSM to fully support the Windows® Security Update and Security Boot.



The following four items appear when you set Launch CSM to [Enabled].

Boot Devices Control [UEFI and Legacy OPROM]

Allows you to select the type of devices that you want to boot up. Configuration options: [UEFI and Legacy OPROM] [Legacy OPROM only] [UEFI only]

Boot from Network Devices [Legacy only]

Allows you to select the type of network devices that you want to launch. Configuration options: [Legacy only] [UEFI driver first] [Ignore]

Boot from Storage Devices [Legacy only]

Allows you to select the type of storage devices that you want to launch. Configuration options: [Legacy only] [UEFI driver first] [Ignore]

Boot from PCI-E Expansion Devices [Legacy only]

Allows you to select the type of PCIe/PCI expansion devices that you want to launch. Configuration options: [Legacy only] [UEFI driver first]

2.7.10 Secure Boot

Allows you to configure the Windows® Secure Boot settings and manage its keys to protect the system from unauthorized access and malwares during POST.

OS Type [Windows UEFI mode]

Allows you to select your installed operating system.

[Windows UEFI mode] This item allows you to select your installed operating system. Execute the Microsoft® Secure Boot check. Only select this option when booting on Windows® UEFI mode or other Microsoft® Secure Boot compliant OS.

[Other OS] Get the optimized function when booting on Windows® non-UEFI mode. Microsoft® Secure Boot only supports Windows® UEFI mode.

Key Management

This allows you to manage the Secure Boot keys.

Install Default Secure Boot keys

This item allows you to immediately load the default Security Boot keys, Platform key (PK), Key-exchange Key (KEK), Signature database (db), and Revoked Signatures (dbx). When the default Secure boot keys are loaded, all the Secure Boot keys' state will change from Unloaded mode to loaded mode.

Clear Secure Boot keys

This item appears only when you load the default Secure Boot keys. This item allows you to clear all the previously applied Secure Boot keys.

Save Secure Boot Keys

This item allows you to save all the Secure Boot keys to a USB storage device.

PK Management

The Platform Key (PK) locks and secures the firmware from any non-permissible changes. The system verifies the PK before your system enters the OS.

Delete PK

Allows you to delete the PK from your system. Once the PK is deleted, all the system's Secure Boot keys will not be active.

Load Default PK

Select Yes to load the system default PK or select No to load a downloaded PK from a USB storage device.



The PK file must be formatted as a UEFI variable structure with time-based authenticated variable.

KEK Management

The KEK (Key-exchange Key or Key Enrollment Key) manages the Signature database (db) and Revoked Signature database (dbx).



Key-exchange Key (KEK) refers to Microsoft® Secure Boot Key-Enrollment Key (KEK).

Delete KEK

Allows you to delete the KEK from your system. Once the KEK is deleted, the db and the dbx cannot be updated in the operating system.

Load Default KEK

Select Yes to load the system default KEK or select No to load a downloaded KEK from a USB storage device.

Append Default KEK

Select Yes to append the system default KEK or select No to append a downloaded additional KEK from a USB storage device for the db and dbx management.



The KEK file must be formatted as a UEFI variable structure with time-based authenticated variable.

DB Management

The db (Authorized Signature database) lists the signers or images of UEFI applications, operating system loaders, and UEFI drivers that you can load on the single computer.

Delete the db

Allows you to delete the db file from your system. Doing so may cause boot failures.

Load Default db

Select Yes to load the system default db or select No to load a downloaded db from a USB storage device.

Append Default db

Select Yes to append the system default db or select No to append a downloaded additional db from a USB storage device to load certain customized UEFI executable files.



-
- The DB file must be formatted as a UEFI variable structure with time-based authenticated variable.
 - UEFI executable files include UEFI boot devices, drivers and applications.
-

dbx Management

The dbx (Revoked Signature database) lists the forbidden images of db items that are no longer trusted and cannot be loaded.

Delete the dbx

Allows you to delete the DBX file from your system. Doing so may expose the system to security threats.

Load Default dbx

Select Yes to load the system default dbx or select No to load a downloaded dbx from a USB storage device.

Append Default dbx

Select Yes to append the system default dbx or select No to append a downloaded additional dbx from a USB storage device to forbid certain customized UEFI executable files.



The DBX file must be formatted as a UEFI variable structure with time-based authenticated variable.

2.7.11 Boot Option Priorities

These items specify the boot device priority sequence from the available devices. The number of device items that appears on the screen depends on the number of devices installed in the system.



- To access Windows® OS in Safe Mode, press <F8 > after POST (Windows® 8 not supported).
 - To select the boot device during system startup, press <F8> when ASUS Logo appears.
-

2.7.12 Boot Override

These items displays the available devices. The number of device items that appears on the screen depends on the number of devices installed in the system. Click an item to start booting from the selected device.

2.8 Tool menu

The Tool menu items allow you to configure options for special functions. Select an item then press <Enter> to display the submenu.

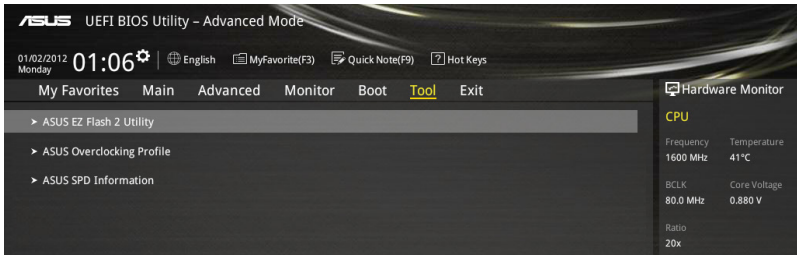

2.8.1 ASUS EZ Flash 2 Utility

Allows you to run ASUS EZ Flash 2. Press [Enter] to launch the ASUS EZ Flash 2 screen.



For more details, see section 2.1.2 ASUS EZ Flash 2.

2.8.2 ASUS Overclocking Profile

This item allows you to store or load multiple BIOS settings.



The **Overclocking Profile** items show **Not assigned** if no profile is created.

Load from Profile

Allows you to load the previous BIOS settings saved in the BIOS Flash. Key in the profile number that saved your CMOS settings, press <Enter>, and then select Yes.



- DO NOT shut down or reset the system while updating the BIOS to prevent the system boot failure!
- We recommend that you update the BIOS file only coming from the same memory/CPU configuration and BIOS version.

Profile Name

Allows you to create a name for the profile you want to save.

Save to Profile

Allows you to save the current BIOS settings to the BIOS Flash, and create a profile. Key in a profile number from one to eight, press <Enter>, and then select Yes.

Load/Save Profile from/to USB Drive

This item allows you to load or save profile from your USB drive, load and save profile to your USB drive.

2.8.3 ASUS SPD Information

DIMM Slot number [DIMM_A1]

Displays the Serial Presence Detect (SPD) information of the DIMM module installed on the selected slot. Configuration options: [DIMM_A1] [DIMM_B1]

2.9 Exit menu

The Exit menu items allow you to load the optimal default values for the BIOS items, and save or discard your changes to the BIOS items.

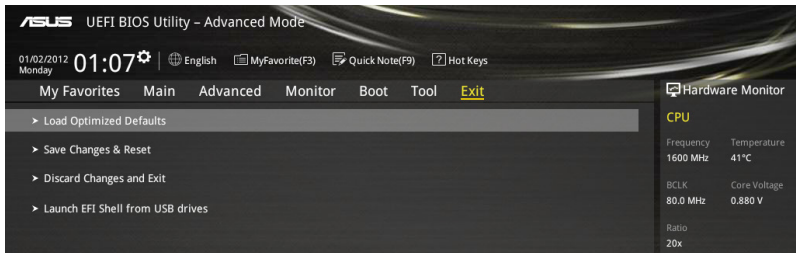

Load Optimized Defaults

This option allows you to load the default values for each of the parameters on the Setup menu. When you select this option or if you press <F5>, a confirmation window appears. Select OK to load the default values.

Save Changes & Reset

Once you are finished making your selections, choose this option from the Exit menu to ensure the values you selected are saved. When you select this option or if you press <F10>, a confirmation window appears. Select OK to save changes and exit.

Discard Changes and Exit

This option allows you to exit the Setup program without saving your changes. When you select this option or if you press <Esc>, a confirmation window appears. Select OK to discard changes and exit.

Launch EFI Shell from USB drives

This option allows you to attempt to launch the EFI Shell application (shellx64.efi) from one of the available USB devices.

Appendices

Notices

Federal Communications Commission Statement

This device complies with Part 15 of the FCC Rules. Operation is subject to the following two conditions:

- This device may not cause harmful interference.
- This device must accept any interference received including interference that may cause undesired operation.

This equipment has been tested and found to comply with the limits for a Class B digital device, pursuant to Part 15 of the FCC Rules. These limits are designed to provide reasonable protection against harmful interference in a residential installation. This equipment generates, uses and can radiate radio frequency energy and, if not installed and used in accordance with manufacturer's instructions, may cause harmful interference to radio communications. However, there is no guarantee that interference will not occur in a particular installation. If this equipment does cause harmful interference to radio or television reception, which can be determined by turning the equipment off and on, the user is encouraged to try to correct the interference by one or more of the following measures:

- Reorient or relocate the receiving antenna.
- Increase the separation between the equipment and receiver.
- Connect the equipment to an outlet on a circuit different from that to which the receiver is connected.
- Consult the dealer or an experienced radio/TV technician for help.



The use of shielded cables for connection of the monitor to the graphics card is required to assure compliance with FCC regulations. Changes or modifications to this unit not expressly approved by the party responsible for compliance could void the user's authority to operate this equipment.

IC: Canadian Compliance Statement

Complies with the Canadian ICES-003 Class B specifications. This device complies with RSS 210 of Industry Canada. This Class B device meets all the requirements of the Canadian interference-causing equipment regulations.

This device complies with Industry Canada license exempt RSS standard(s). Operation is subject to the following two conditions: (1) this device may not cause interference, and (2) this device must accept any interference, including interference that may cause undesired operation of the device.

Cet appareil numérique de la Classe B est conforme à la norme NMB-003 du Canada.

Cet appareil numérique de la Classe B respecte toutes les exigences du Règlement sur le matériel brouilleur du Canada.

Cet appareil est conforme aux normes CNR exemptes de licence d'Industrie Canada. Le fonctionnement est soumis aux deux conditions suivantes :

- (1) cet appareil ne doit pas provoquer d'interférences et
- (2) cet appareil doit accepter toute interférence, y compris celles susceptibles de provoquer un fonctionnement non souhaité de l'appareil.

Canadian Department of Communications Statement

This digital apparatus does not exceed the Class B limits for radio noise emissions from digital apparatus set out in the Radio Interference Regulations of the Canadian Department of Communications.

This class B digital apparatus complies with Canadian ICES-003.

VCCI: Japan Compliance Statement

VCCI Class B Statement

この装置は、クラスB 情報技術装置です。この装置は、家庭環境で使用することを目的としていますが、この装置がラジオやテレビジョン受信機に近接して使用されると、受信障害を引き起こすことがあります。

取扱説明書に従って正しい取り扱いをして下さい。

V C C I - B

This is a Class B product based on the standard of the VCCI Council. If this is used near a radio or television receiver in a domestic environment, it may cause radio interference. Install and use the equipment according to the instruction manual.

KC: Korea Warning Statement

B급 기기 (가정용 방송통신기자재)

이 기기는 가정용(B급) 전자파적합기기로서 주로 가정에서 사용하는 것을 목적으로 하며, 모든 지역에서 사용할 수 있습니다.

*당해 무선설비는 전파혼신 가능성이 있으므로 인명안전과 관련된 서비스는 할 수 없습니다.

REACH

Complying with the REACH (Registration, Evaluation, Authorisation, and Restriction of Chemicals) regulatory framework, we published the chemical substances in our products at ASUS REACH website at <http://csr.asus.com/english/REACH.htm>.



DO NOT throw the motherboard in municipal waste. This product has been designed to enable proper reuse of parts and recycling. This symbol of the crossed out wheeled bin indicates that the product (electrical and electronic equipment) should not be placed in municipal waste. Check local regulations for disposal of electronic products.



DO NOT throw the mercury-containing button cell battery in municipal waste. This symbol of the crossed out wheeled bin indicates that the battery should not be placed in municipal waste.

ASUS Recycling/Takeback Services

ASUS recycling and takeback programs come from our commitment to the highest standards for protecting our environment. We believe in providing solutions for you to be able to responsibly recycle our products, batteries, other components as well as the packaging materials. Please go to <http://csr.asus.com/english/Takeback.htm> for detailed recycling information in different regions.

English AsusTek Inc. hereby declares that this device is in compliance with the essential requirements and other relevant provisions of CE Directives. Please see the CE Declaration of Conformity for more details.

Français AsusTek Inc. déclare par la présente que cet appareil est conforme aux critères essentiels et autres clauses pertinentes des directives européennes. Veuillez consulter la déclaration de conformité CE pour plus d'informations.

Deutsch AsusTek Inc. erklärt hiermit, dass dieses Gerät mit den wesentlichen Anforderungen und anderen relevanten Bestimmungen der CE-Richtlinien übereinstimmt. Weitere Einzelheiten entnehmen Sie bitte der CE-Konformitätserklärung.

Italiano AsusTek Inc. con la presente dichiara che questo dispositivo è conforme ai requisiti essenziali e alle altre disposizioni pertinenti alle direttive CE. Per maggiori informazioni fate riferimento alla dichiarazione di conformità CE.

Компанија ASUS заявљује, да је ово уређај у складу са основним захтевима и другим релевантним одредбама CE директива. Подробнију информацију, пожељно је, погледати у декларацији о усклађености.

Български С настоящото AsusTek Inc. декларира, че това устройство е в съответствие със съществените изисквания и другите приложими постановления на директивите CE. Вижте CE декларацията за съвместимост за повече информация.

Hrvatski AsusTek Inc. ovim izjavljuje da je ovaj uređaj sukladan s bitnim zahtjevima i ostalim odgovarajućim odredbama CE direktiva. Više pojedinosti potražite u CE izjavi o sukladnosti.

Čeština Společnost AsusTek Inc. tímto prohlašuje, že toto zařízení splňuje základní požadavky a další příslušná ustanovení směrnice CE. Další podrobnosti viz Prohlášení o shodě CE.

Dansk AsusTek Inc. Erklærer hermed, at denne enhed er i overensstemmelse med hovedkravene and andre relevante bestemmelser i CE-direktiverne. Du kan læse mere i CE-overensstemmelseserklæring.

Nederlands AsusTek Inc. verklaart hierbij dat dit apparaat compatibel is met de essentiële vereisten en andere relevante bepalingen van CE-richtlijnen. Raadpleeg de CE-verklaring van conformiteit voor meer details.

Eesti Käesolevaga kinnitab AsusTek Inc., et see seade vastab CE direktiivide olulistele nõuetele ja teistele asjakohastele sätetele. Vt üksikasju CE vastavusdeklaratsioonist.

Suomi AsusTek Inc. vakuuttaa täten, että tämä laite on CE-direktiivien olennaisten vaatimusten ja muiden asiaan kuuluvien lisäysten mukainen. Katso lisätietoja CE-vaatimustenmukaisuusvakuutuksesta.

Ελληνικά Με το παρόν, η AsusTek Inc. δηλώνει ότι αυτή η συσκευή συμμορφώνεται με τις θεμελιώδεις απαιτήσεις και άλλες σχετικές διατάξεις των Οδηγιών της ΕΕ. Για περισσότερες λεπτομέρειες ανατρέξτε στην Δήλωση Συμμόρφωσης ΕΕ.

Magyar Az AsusTek Inc. ezennel kijelenti, hogy a készülék megfelel a CE-irányelvek alapvető követelményeinek és ide vonatkozó egyéb rendelkezéseinek. További részletekért tekintse meg a CE-megfelelőségi nyilatkozatot.

Latviski Līdz ar šo AsusTek Inc. paziņo, ka šī ierīce atbilst būtiskajām prasībām un citiem saistošajiem nosacījumiem, kas norādīti CE direktīvā. Lai uzzinātu vairāk, skatiet CE Atbilstības deklarāciju.

Lietuvių Šiuo dokumentu bendrovė „AsusTek Inc.“ pareiškia, kad šis įrenginys atitinka pagrindinius CE direktyvų reikalavimus ir kitas susijusias nuostatas. Daugiau informacijos rasite CE atitikties deklaracijoje.

Norsk AsusTek Inc. erklærer herved at denne enheten er i samsvar med hovedsaklige krav og andre relevante forskrifter i CE-direktiver. Du finner mer informasjon i CE-samsvarserklæringen.

Polski Niniejszym AsusTek Inc. deklaruje, że to urządzenie jest zgodne z istotnymi wymaganiami oraz innymi powiązanymi zaleceniami Dyrektyw CE. W celu uzyskania szczegółów, sprawdź Deklarację zgodności CE.

Português A AsusTek Inc. declara que este dispositivo está em conformidade com os requisitos essenciais e outras disposições relevantes das Diretivas da CE. Para mais detalhes, consulte a Declaração de Conformidade CE.

Română Prin prezenta, AsusTek Inc. declară faptul că acest dispozitiv respectă cerințele esențiale și alte prevederi relevante ale directivelor CE. Pentru mai multe detalii, consultați declarația de conformitate CE.

Srpski AsusTek Inc. ovim izjavljuje da je ovaj uređaj u saglasnosti sa ključnim zahtjevima i drugim relevantnim odredbama CE Direktiva. Molimo vas, pogledajte CE Deklaraciju o usklađenosti za više detalja.

Slovensky Spoločnosť AsusTek Inc. týmto prehlasuje, že toto zariadenie vyhovuje príslušným požiadavkám a ďalším súvisiacim ustanoveniam smerníc ES. Viac podrobností si pozrite v prehlásení o zhode ES.

Slovenščina AsusTek Inc. tukaj izjavlja, da je ta naprava skladna s temeljnimi zahtevami in drugimi relevantnimi določili direktiv CE. Za več informacij glejte Izjavo CE o skladnosti.

Español Por la presente, AsusTek Inc. declara que este dispositivo cumple los requisitos básicos y otras disposiciones relevantes de las directivas de la CE. Consulte la Declaración de conformidad de la CE para obtener más detalles.

Svenska AsusTek Inc. förklarar härmed att denna enhet är i överensstämmelse med de grundläggande kraven och andra relevanta bestämmelser i CE-direktiven. Se CE-försäkran om överensstämmelse för mer information.

Українська AsusTek Inc. заявляє, що цей пристрій відповідає основним вимогам відповідних Директив ЄС. Будь ласка, див. більше подробиць у Декларації відповідності нормам ЄС.

Türkçe AsusTek Inc., bu aygıtın temel gereksinimlerle ve CE Yönergelerinin diğer ilgili koşullarıyla uyumlu olduğunu beyan eder. Daha fazla ayrıntı için lütfen CE Uygunluk Beyanına bakın.

Bosanski AsusTek Inc. ovim potvrđuje da je ovaj uređaj uskladen s osnovnim zahtjevima i drugim relevantnim propisima Direktiva EK. Za više informacija molimo pogledajte Deklaraciju o usklađenosti EK.

ASUS contact information

ASUSTeK COMPUTER INC.

Address 15 Li-Te Road, Peitou, Taipei, Taiwan 11259
Telephone +886-2-2894-3447
Fax +886-2-2890-7798
E-mail info@asus.com.tw
Web site <http://www.asus.com>

Technical Support

Telephone +86-21-3842-9911
Fax +86-21-5866-8722 ext. 9101#
Online support <http://support.asus.com/techserv/techserv.aspx>

ASUS COMPUTER INTERNATIONAL (America)

Address 800 Corporate Way, Fremont, CA 94539, USA
Telephone +1-510-739-3777
Fax +1-510-608-4555
Web site <http://www.asus.com/us/>

Technical Support

Support fax +1-812-284-0883
General support +1-812-282-2787
Online support <http://www.service.asus.com/>

ASUS COMPUTER GmbH (Germany and Austria)

Address Harkort Str. 21-23, D-40880 Ratingen, Germany
Fax +49-2102-959931
Web site <http://www.asus.com/de>
Online contact <http://eu-rma.asus.com/sales>

Technical Support

Telephone +49-2102-5789555
Support Fax +49-2102-959911
Online support <http://www.asus.com/de/support/>

DECLARATION OF CONFORMITY

Per FCC Part 2, Section 2.1077(e)



Responsible Party Name: **Asus Computer International**

Address: **800 Corporate Way, Fremont, CA 94539**

Phone/Fax No: **(510)739-3777/(510)608-4555**

hereby declares that the product

Product Name : Motherboard

Model Number : N3050I-C N3050I-C/BR N3150I-C

Conforms to the following specifications:

FCC Part 15, Subpart B, Unintentional Radiators

Supplementary Information:

This device complies with part 15 of the FCC Rules. Operation is subject to the following two conditions: (1) This device may not cause harmful interference, and (2) this device must accept any interference received, including interference that may cause undesired operation.

Representative Person's Name : Steve Chang / President

Signature :

Date : Apr. 07, 2015

Ver. 14031



EC Declaration of Conformity

Who, the undersigned,

Manufacturer: **ASUSTeK COMPUTER INC.**
4F, No. 150, LI TE RD, PEITOU, TAIPEI 112, TAIWAN
Authorized representative in Europe: **ASUS COMPUTER GmbH**
Address, City: **HARKORT STR. 21-23, 40860 RATINGEN**
Country: **GERMANY**

declare the following apparatus:

Product name : **Motherboard**
Model name : **N3050I-C N3050I-C/BR N3150I-C**

conform with the essential requirements of the following directives:

2004/108/EC-EMC Directive
 EN 55022:2010/A2:2011
 EN 55024:2010
 EN 55025:2010/A2:2011
 EN 55026:2010
 EN 55027:2010/A2:2011
 EN 55028:2010
 EN 55029:2010

1989/EC-RATE Directive
 EN 300 328 V1.7 (2005-10)
 EN 300 440-1 V1.6 (2010-08)
 EN 300 440-2 V1.6 (2010-08)
 EN 300 511 V1.2 (2006-06)
 EN 300 487 V1.4 (2006-05)
 EN 300 489-1 V1.4 (2007-11)
 EN 300 489-2 V1.4 (2007-11)
 EN 300 489-3 V1.4 (2007-11)
 EN 300 489-4 V1.4 (2007-11)
 EN 300 489-5 V1.4 (2007-11)
 EN 300 489-6 V1.4 (2007-11)
 EN 300 489-7 V1.4 (2007-11)
 EN 300 489-8 V1.4 (2007-11)
 EN 300 489-9 V1.4 (2007-11)
 EN 300 489-10 V1.4 (2007-11)
 EN 300 489-11 V1.4 (2007-11)
 EN 300 489-12 V1.4 (2007-11)
 EN 300 489-13 V1.4 (2007-11)
 EN 300 489-14 V1.4 (2007-11)
 EN 300 489-15 V1.4 (2007-11)
 EN 300 489-16 V1.4 (2007-11)
 EN 300 489-17 V1.4 (2007-11)
 EN 300 489-18 V1.4 (2007-11)
 EN 300 489-19 V1.4 (2007-11)
 EN 300 489-20 V1.4 (2007-11)
 EN 300 489-21 V1.4 (2007-11)
 EN 300 489-22 V1.4 (2007-11)
 EN 300 489-23 V1.4 (2007-11)
 EN 300 489-24 V1.4 (2007-11)
 EN 300 489-25 V1.4 (2007-11)
 EN 300 489-26 V1.4 (2007-11)
 EN 300 489-27 V1.4 (2007-11)
 EN 300 489-28 V1.4 (2007-11)
 EN 300 489-29 V1.4 (2007-11)
 EN 300 489-30 V1.4 (2007-11)
 EN 300 489-31 V1.4 (2007-11)
 EN 300 489-32 V1.4 (2007-11)
 EN 300 489-33 V1.4 (2007-11)
 EN 300 489-34 V1.4 (2007-11)
 EN 300 489-35 V1.4 (2007-11)
 EN 300 489-36 V1.4 (2007-11)
 EN 300 489-37 V1.4 (2007-11)
 EN 300 489-38 V1.4 (2007-11)
 EN 300 489-39 V1.4 (2007-11)
 EN 300 489-40 V1.4 (2007-11)
 EN 300 489-41 V1.4 (2007-11)
 EN 300 489-42 V1.4 (2007-11)
 EN 300 489-43 V1.4 (2007-11)
 EN 300 489-44 V1.4 (2007-11)
 EN 300 489-45 V1.4 (2007-11)
 EN 300 489-46 V1.4 (2007-11)
 EN 300 489-47 V1.4 (2007-11)
 EN 300 489-48 V1.4 (2007-11)
 EN 300 489-49 V1.4 (2007-11)
 EN 300 489-50 V1.4 (2007-11)
 EN 300 489-51 V1.4 (2007-11)
 EN 300 489-52 V1.4 (2007-11)
 EN 300 489-53 V1.4 (2007-11)
 EN 300 489-54 V1.4 (2007-11)
 EN 300 489-55 V1.4 (2007-11)
 EN 300 489-56 V1.4 (2007-11)
 EN 300 489-57 V1.4 (2007-11)
 EN 300 489-58 V1.4 (2007-11)
 EN 300 489-59 V1.4 (2007-11)
 EN 300 489-60 V1.4 (2007-11)
 EN 300 489-61 V1.4 (2007-11)
 EN 300 489-62 V1.4 (2007-11)
 EN 300 489-63 V1.4 (2007-11)
 EN 300 489-64 V1.4 (2007-11)
 EN 300 489-65 V1.4 (2007-11)
 EN 300 489-66 V1.4 (2007-11)
 EN 300 489-67 V1.4 (2007-11)
 EN 300 489-68 V1.4 (2007-11)
 EN 300 489-69 V1.4 (2007-11)
 EN 300 489-70 V1.4 (2007-11)
 EN 300 489-71 V1.4 (2007-11)
 EN 300 489-72 V1.4 (2007-11)
 EN 300 489-73 V1.4 (2007-11)
 EN 300 489-74 V1.4 (2007-11)
 EN 300 489-75 V1.4 (2007-11)
 EN 300 489-76 V1.4 (2007-11)
 EN 300 489-77 V1.4 (2007-11)
 EN 300 489-78 V1.4 (2007-11)
 EN 300 489-79 V1.4 (2007-11)
 EN 300 489-80 V1.4 (2007-11)
 EN 300 489-81 V1.4 (2007-11)
 EN 300 489-82 V1.4 (2007-11)
 EN 300 489-83 V1.4 (2007-11)
 EN 300 489-84 V1.4 (2007-11)
 EN 300 489-85 V1.4 (2007-11)
 EN 300 489-86 V1.4 (2007-11)
 EN 300 489-87 V1.4 (2007-11)
 EN 300 489-88 V1.4 (2007-11)
 EN 300 489-89 V1.4 (2007-11)
 EN 300 489-90 V1.4 (2007-11)
 EN 300 489-91 V1.4 (2007-11)
 EN 300 489-92 V1.4 (2007-11)
 EN 300 489-93 V1.4 (2007-11)
 EN 300 489-94 V1.4 (2007-11)
 EN 300 489-95 V1.4 (2007-11)
 EN 300 489-96 V1.4 (2007-11)
 EN 300 489-97 V1.4 (2007-11)
 EN 300 489-98 V1.4 (2007-11)
 EN 300 489-99 V1.4 (2007-11)
 EN 300 489-100 V1.4 (2007-11)

2009/EC-LVD Directive
 EN 60950-1 / A2:2013
 EN 60950-2 / A2:2013
 2009/125/EC-EP Directive
 Regulation (EC) No. 1275-2008
 Regulation (EC) No. 642/2009
 Regulation (EC) No. 617/2013

Ver. 14031



(EC conformity marking)

Position : **CEO**
Name : **Jerry Shen**

Signature : _____

Declaration Date: **07/04/2015**
Year to begin affixing CE marking: **2015**

