

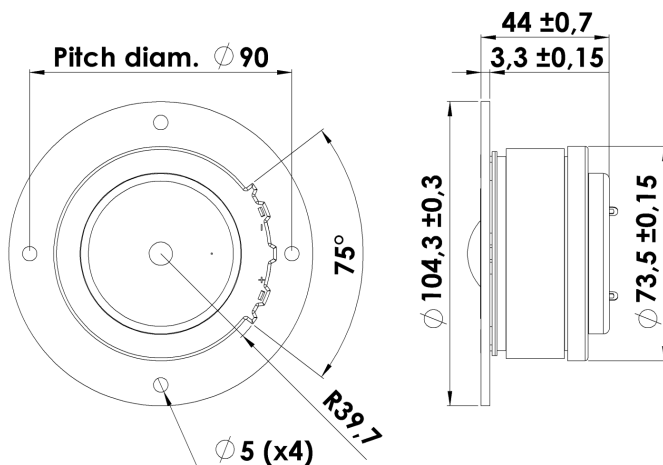

TWEETER

D2905/950000

The Classic tweeters are among the many highly praised designs in Classic series. They have enjoyed success over 3 decades. And still among the best tweeters available. The D2905/9000 tweeter kick-started a new era with a line of very high quality 1" tweeters, today known as -9300, -9500, -9700 and -9800. Despite their many years on the market still used in many top High-End speakers around the world.



KEY FEATURES:

- 1" Textile Dome Diaphragm
- Low Resonance Rear Chamber
- Ferro Fluid
- Black Painted Alu Face Plate

T-S Parameters

Resonance frequency [fs]	550 Hz
Mechanical Q factor [Qms]	1.04
Electrical Q factor [Qes]	0.60
Total Q factor [Qts]	0.38
Force factor [Bl]	3.5 Tm
Mechanical resistance [Rms]	1.50 kg/s
Moving mass [Mms]	0.45 g
Suspension compliance [Cms]	0.19 mm/N
Effective diaph. diameter [D]	33 mm
Effective piston area [Sd]	8.5 cm ²
Equivalent volume [Vas]	0.02 l
Sensitivity (2.83V/1m)	90 dB
Ratio Bl/√Re	1.61 N/√W
Ratio fs/Qts	1452 Hz

Notes:

IEC specs. refer to IEC 60268-5 third edition.
All Scan-Speak products are RoHS compliant.
Data are subject to change without notice.
Datasheet updated: February 22, 2011.

Electrical Data

Nominal impedance [Zn]	6 Ω
Minimum impedance [Zmin]	5.5 Ω
Maximum impedance [Zo]	12.9 Ω
DC resistance [Re]	4.7 Ω
Voice coil inductance [Le]	0.07 mH

Power Handling

100h RMS noise test (IEC 17.1)*	150 W
Long-term max power (IEC 17.3)*	- W

*Filter: 2. order HP Butterworth, 2.5 kHz

Voice Coil and Magnet Data

Voice coil diameter	28 mm
Voice coil height	3.3 mm
Voice coil layers	2
Height of gap	2.5 mm
Linear excursion	± 0.4 mm
Max mech. excursion	± 1.5 mm
Unit weight	0.7 kg



TWEETER

D2905/950000

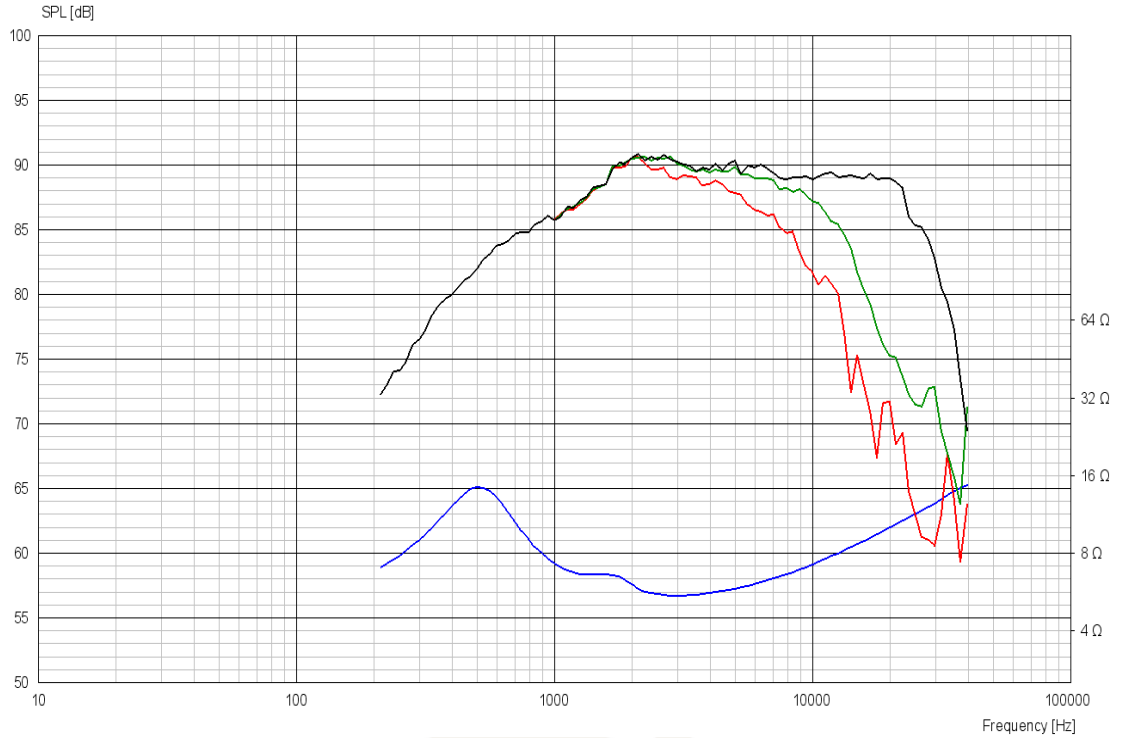

Advanced Parameters (Preliminary)

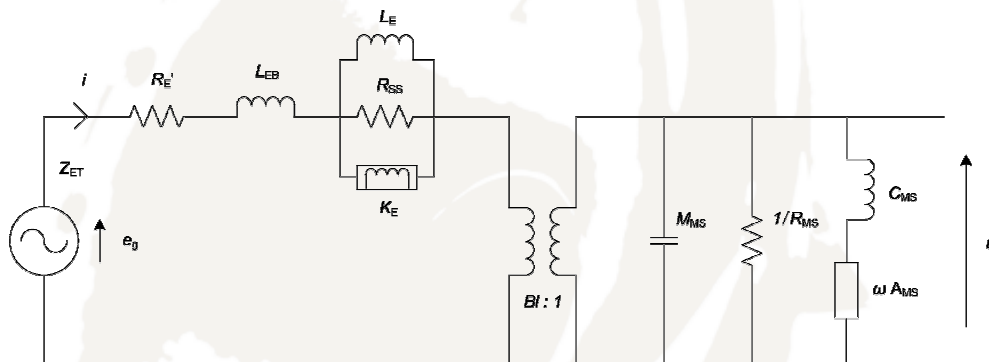

Electrical data:

Resistance [Re']	- Ω
Free inductance [Leb]	- mH
Bound inductance [Le]	- mH
Semi-inductance [Ke]	- SH
Shunt resistance [Rss]	- Ω

Mechanical Data

Force Factor [Bl]	- Tm
Moving mass [Mms]	- g
Compliance [Cms]	- mm/N
Mechanical resistance [Rms]	- kg/s
Admittance [Ams]	- mm/N