

Operating Manual

Equipment

■ Auro 2216 PS

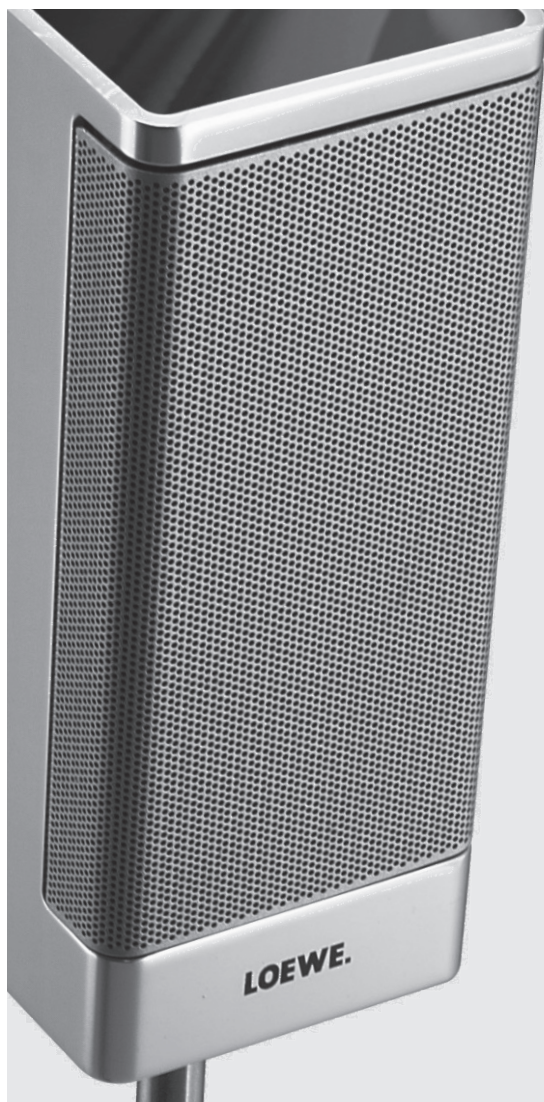

LOEWE.

233-32 486 025



Contents

Remote control Assist – DVD-operation	3		
Auro 2216 PS Front Panel	4	Audio-CD	28
Auro 2216 PS Rear Panel & Display	5	MP3 and JPEG	32
Welcome	6	Child Lock	34
Thank you,	6	Tuner	36
Scope of delivery	6	Audio functions	38
Set up	6	Setting the remote control	40
Disposal	6	Remote control Assist – TV-operation	41
Cleaning	7	What to do, if ...	42
For your safety	7	Technical Data	43
Advantages of connection to a Loewe TV set	7	Service	44
First installation	8		
Connection	8		
Wiring Loewe Flat TV – Auro – Individual Sound/Tremo	9		
Wiring Auro – audio system	10		
Remote control	10		
Setting the language	11		
Activate Digital Link	12		
Switch over PAL/NTSC	12		
Doing a reset	12		
Switching over to Progressive Scan	12		
Setting the loudspeaker system	13		
About operation	15		
Activate the mode of the remote control	15		
Inserting a disc	15		
Basic functions	15		
User interface	15		
User interface of the inserted DVD	18		
Sleep timer	18		
Numeric input	18		
Automatic functions	18		
Inserting a disc	19		
Basic functions	19		
DVD	19		
Extended functions	22		
Basic settings	25		
Special features of DVD Audio	26		

Remote control Assist – DVD-operation

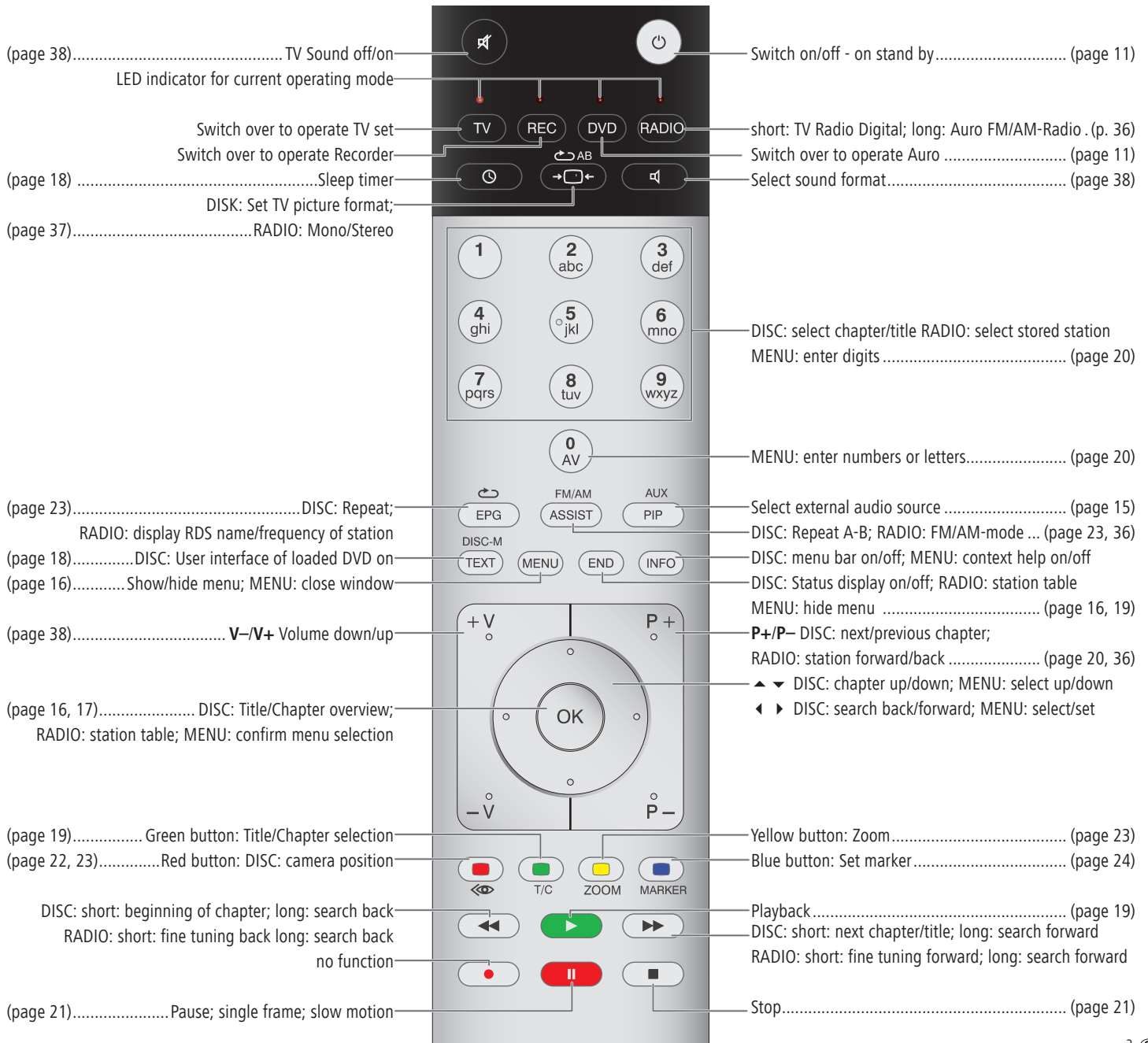

Auro 2216 PS Front Panel

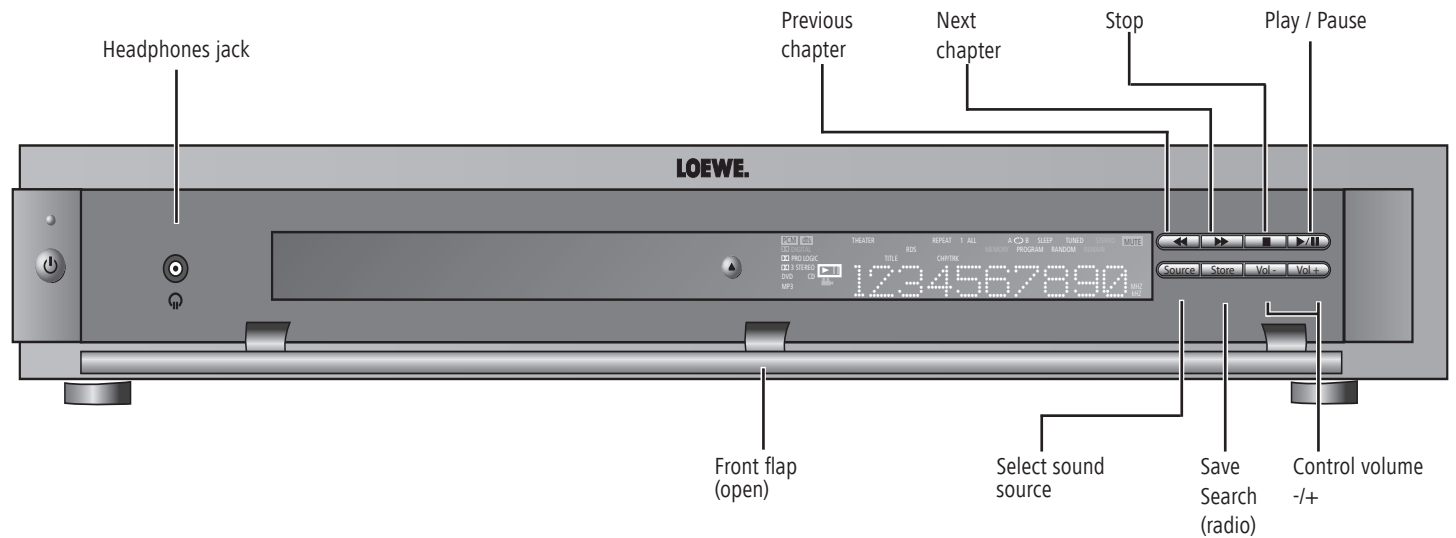
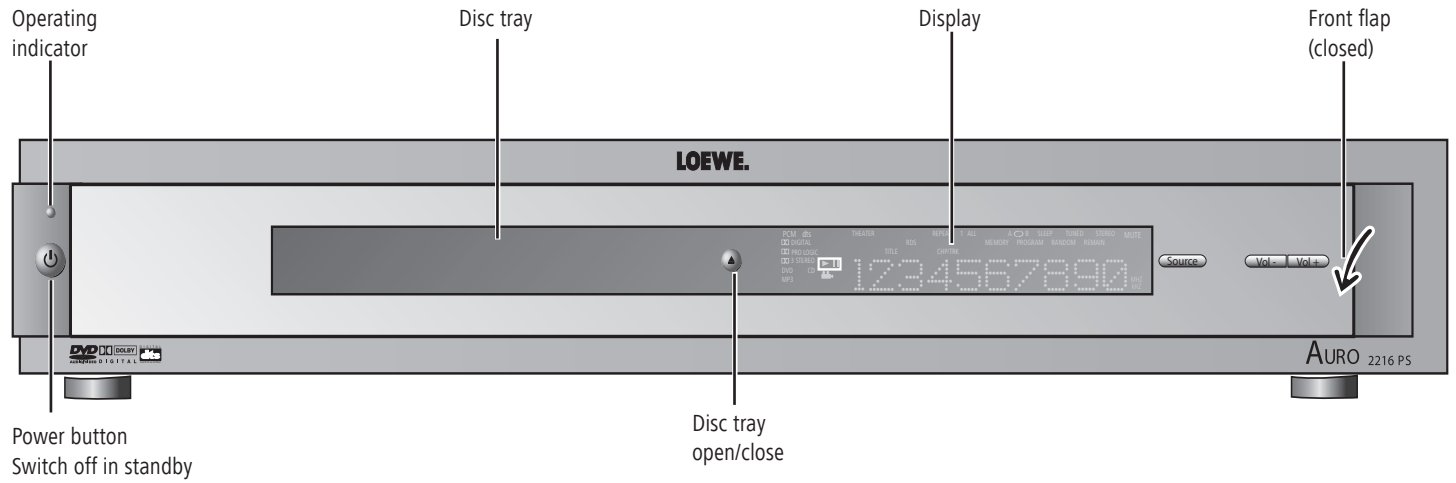

Auro 2216 PS Rear Panel & Display

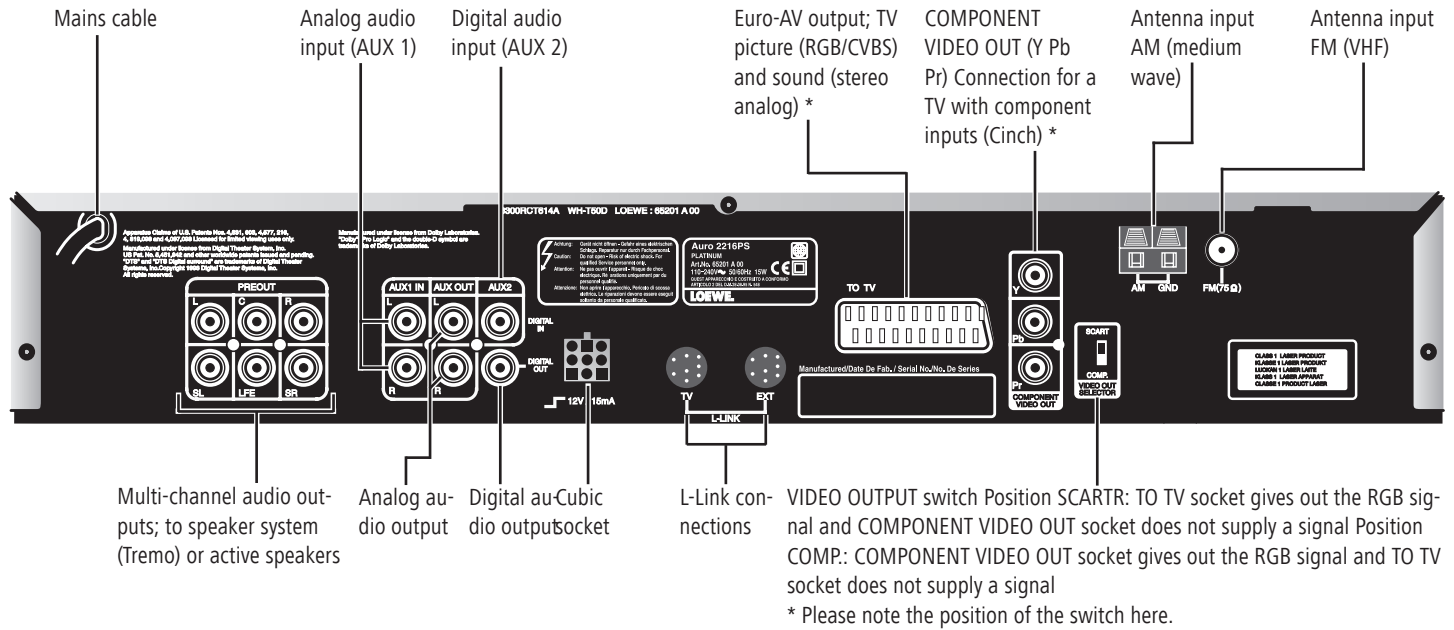

Caution: Do not touch the inner pins of connection sockets on the rear panel. Electrostatic discharge may cause permanent damage to the unit.

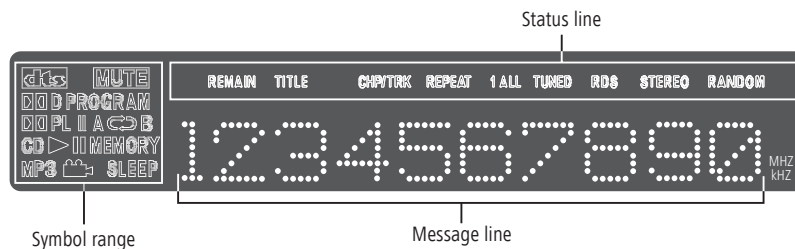

to the status line:

- REMAIN** Remaining playing time (DVD/CD).
- TITLE** Current title (DVD/CD).
- CHP/TRK** Current chapter/title (DVD/CD).
- REPEAT** Repeat chapter/title (DVD/CD)
- 1 ALL** Repeat disc (DVD/CD)
- TUNED** Adequate reception quality (tuner)
- RDS** Station with RDS name (tuner)
- STEREO** see page 40
- RANDOM** CD Random (DVD/CD)

Welcome

Thank you,

for choosing a Loewe product. We are happy to welcome you as our customer.

At Loewe we combine the highest standards of technology, design and user friendliness. This is equally true of TV, DVD, video, audio and accessories.

Neither technology nor design is an end in itself, but both are intended to provide our customers with the best possible audio and visual experience.

Our design is not influenced by short-term, fashionable trends. You have, after all, purchased a high-quality piece of equipment which you do not want to get tired of looking at tomorrow or the day after.

You can control four units with the remote control, a Loewe TV set, a Loewe video recorder or a Loewe DVD recorder in addition to this DVD preceiver.

Scope of delivery

- DVD-Preceiver Loewe Auro 2216 PS
- Assist remote control with 2 batteries
- Euro AV cable (Scart cable)
- Cubic plug cable
- L-Link cable
- Audio cinch cable
- Digital-Audio-Cinch-cable
- Antenna cable
- AM antenna
- this operating manual

Set up

- Place the DVD-Preceiver on a firm, level base.
- Do not place the DVD-Preceiver in the vicinity of sources of intense heat or in direct sunlight.
- When installing in a cabinet or enclosed shelf: Leave about 2.5cm free space around the DVD Preceiver for unhindered air circulation to prevent build-up of heat.
- There can be interference to the images and sound of any nearby television, video recorder or radio. If this occurs, do not place the unit near to a television, video recorder or radio, or switch the unit off after removing the disc.
- Install the DVD-Preceiver where there is nothing to obstruct the remote control's infrared signal from reaching the DVD-Preceiver display.
- Do not place strong artificial light sources in front of the device. This may affect infrared reception.
- If there is an electrical storm, disconnect the antenna and mains plug. Power surges caused by lightning strikes can damage the unit through the antenna system or the mains.
- The antenna and mains should also be disconnected if the unit is to remain unsupervised for a long period of time.

- The mains plug must be easily accessible so that the unit can be disconnected at any time.
- Lay the cable in such a way that it cannot get damaged. The power cable should not be kinked or laid over sharp edges, not stood upon or exposed to chemicals - the latter also applies to the device as a whole. A mains cable with damaged insulation can cause electric shocks and is a fire hazard.
- When removing the power plug, pull the body of the plug, and not the cable. Otherwise, the wires in the plug could get damaged and cause a short circuit the next time it is plugged in.

You should also read and follow the safety advice on the following pages.

Disposal

Cardboard box and packaging

You have opted for a durable and technically sophisticated product. In line with national regulations regarding the disposal of packaging materials, we pay a fee to authorised recyclers who collect packaging from dealers. However, we recommend that you keep the original cardboard box and the rest of the packaging materials so that the unit can, if necessary, be transported in the safest possible conditions.

The unit



Important: The EU Directive 2002/96/EG governs the proper re-acceptance, handling and recycling of used electronic appliances.

Old electronic appliances must therefore be disposed of separately.

Never throw this set in the normal domestic waste. You can hand in your old set free of charge at identified collection points or at your dealer if you buy a similar new set. Other details about re-acceptance (also for non-EU countries) are available from your local administration.

Welcome

Cleaning

- Only clean your DVD-Preceiver with a damp, soft, clean cloth (with no aggressive cleaning agents).
- If DVD-Preceiver fails to read the disc correctly, the reader unit in the device may be soiled. Use a commercially-available cleaning disc.
- Always keep the disc drawer closed to prevent dust getting into the drawer and onto the lens.

For your safety

For your own safety and to avoid unnecessary damage to your unit, please read and follow the safety advice below:

- This DVD-Preceiver is only to be used for receiving, displaying and playing visual and sound signals.
- Switch off your DVD system (Centros, TV and any other audio components which may be connected) before connecting or disconnecting other devices or speakers.

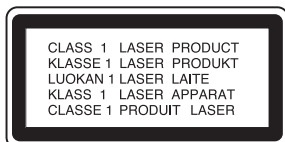

- Do not open up the housing, or you could be directly exposed to the laser beam. The laser beam will be visible if the unit is open.
DO NOT LOOK INTO THE LASER BEAM.

Protect your DVD-Preceiver from:

- liquids and damp
- shock and mechanical stress
- magnetic and electrical fields
- cold, heat, direct sunlight and extreme fluctuations in temperature
- dust
- anything which obstructs ventilation
- manual interference with the unit's interior

Your Auro has only been designed for use in a domestic environment. The warranty covers this normal use of the DVD-Preceiver.

PLEASE NOTE: TO AVOID RISK OF ELECTRICAL SHOCK, DO NOT REMOVE THE COVER (OR THE REAR OF THE UNIT). THERE ARE NO PARTS INSIDE THE UNIT THAT CAN BE REPAIRED BY THE USER. REPAIRS SHOULD ONLY BE CARRIED OUT BY A LOEWE DEALER.

If you have moved the DVD-Preceiver from a cold to a warm environment, leave it to stand for about an hour because of the risk of condensation building up. Do not switch it on until it has reached room temperature. This will avoid seriously damaging the components.

Read this operating manual, and experiment with your new equipment's features so that you are familiar with it.

Advantages of connection to a Loewe TV set

If you connect your Auro to a Loewe TV, you are able to enjoy the Loewe system communication "L-Link". With L-Link, Auro and your TV join forces in an intelligent network and form a high-performance home cinema system.

Auro and the TV exchange data via the L-Link, among other things to check whether audio data are available (screen stays off) or whether audio and video data are available (screen switches on automatically).

Thanks to L-Link your TV assumes that Auro will take over processing of all audio signals within the equipment network. The Auro switches on automatically when you switch on the TV.

You can operate the whole equipment network with "one hand" using the Assist remote control.

Technical requirements for L-Link

- Loewe TV of chassis generation Q/S/P25xx TV software as of Version 6.0; if your TV is equipped with an older software, please contact your Loewe dealer for a software update
- L-Link cable connection must be established in a powerless state; see page 8/9.
- Auro must be connected to the Euro AV-input AV2/3 of the TV; see page 9.

First installation

Connection

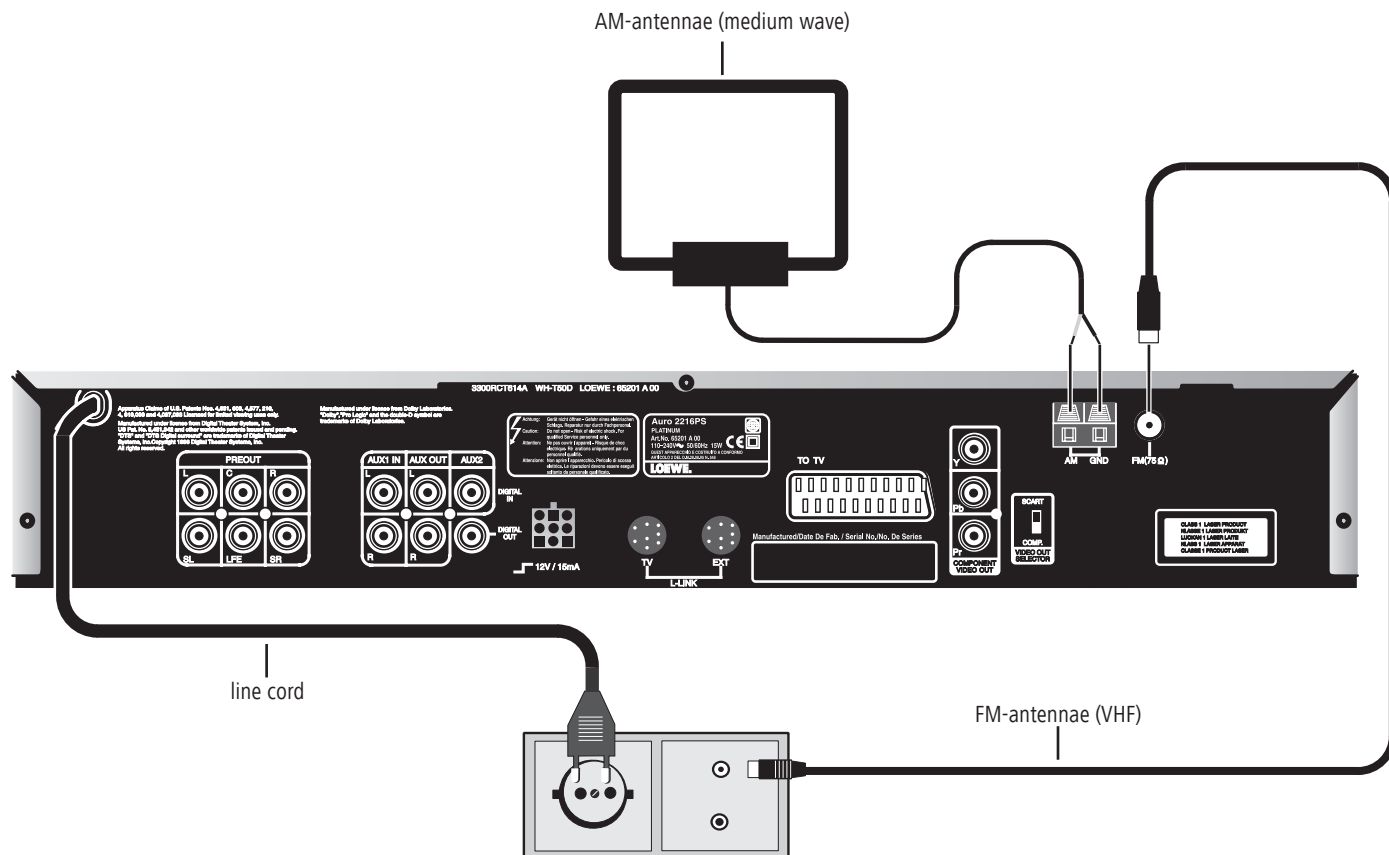

Attention: : All the devices involved must be disconnected from the mains when you are connecting the cables.

Connecting antennae

Connect the antennae for VHF (FM) and medium wave (AM) as shown in the drawing:

- Connect the enclosed AM antenna to the appropriate terminals – the light insulated wire to terminal "AM", the dark insulated wire to terminal "GND".
- Make sure the AM antenna and the TV are a great distance apart because the

TV interferes with AM reception when it is on.

- Connect the antenna input "FM" to an antenna system or FM antenna. Do not use a cubical antenna if possible because the reception performance of cubical antennae is usually unsatisfactory.

First installation

Wiring Loewe Flat TV – Auro – Individual Sound/Tremo

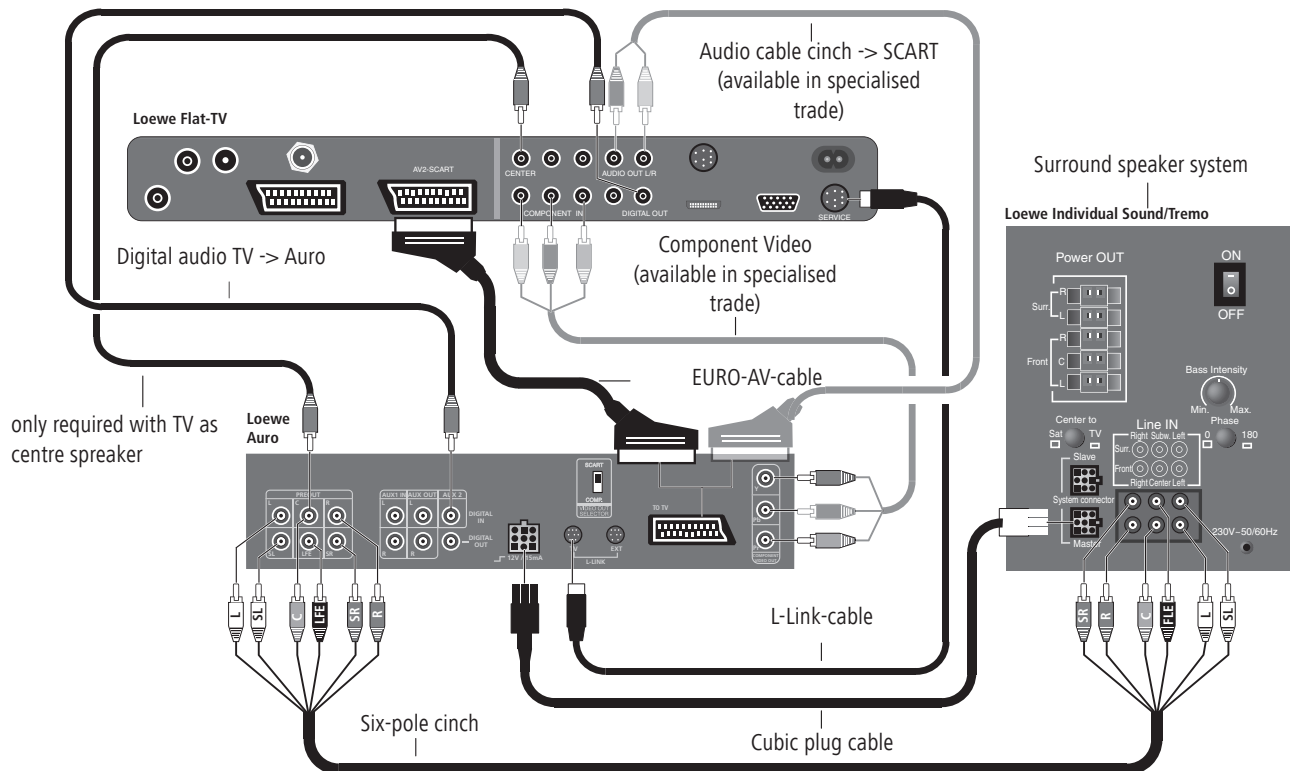

Connect the cables as shown in the graphic:

- Connect the Auro to socket AV2 of the Loewe Flat TV. If your Loewe TV set has three AV sockets, use socket AV3.
- You must use a Euro-AV cable in which all contacts are connected with each other (21-fold as in the case with the enclosed cable).
- To get a better picture quality, use a three-wire cinch cable and connect it to Auro "COMPONENT VIDEO OUT" and "SD/HD-COMPONENT IN" of the TV set. Pay attention to the exact polarity of the Y/Cb/Cr signals. In addition you have to switch the "VIDEO OUT SELECTOR" switch on the back of the Auro to the "COMP." position.
- Letters are embossed on the sides of the plugs on the six-wire cinch cable: gray plug: "C" for center channel; black plug: "LFE" for subwoofer; red plug: "FR" for front right or "SR" for surround right; white plug: "FL" for front left or "SL" for surround left.
- Two-wire (thin) cubic plug cable from Auro to the "Master" socket on Individual Sound/Tremo (connect the end of the cable with kink protection to Auro). The cubic plugs are secured in the socket by a lug. You have to press down the lug first before you can remove the cubic plug.

- For TV as center loudspeaker use a cinch cable to connect "AUDIO IN C" on the TV set with "PRE OUT C" on the DVD Preceiver (the connection of the gray plug "C" between Auro and Individual Sound/Tremo is omitted). In addition, you have to move the "Center to" switch on the back of Individual Sound/Tremo to the "TV" position (switch must be pressed); see the separate operating manual for Individual Sound/Tremo.
- To play the TV sound over Auro/Individual Sound/Tremo, connect the digital audio output of the TV set "AUDIO DIGITAL OUT" with the "DIGITAL IN" input from Auro with a cinch cable.
- When establishing the L-Link, Auro and the TV must be in the powerless state, otherwise, these devices cannot identify each other after switching on; for L-Link see page 7.
- You can connect an additional external analogue source to the analogue audio input AUX 1 IN.
- Audio cable cinch -> SCART (available in specialised trade) for use of the component signal and "TV as centre loudspeaker" - see note on page 42.

First installation

Wiring Auro – audio system

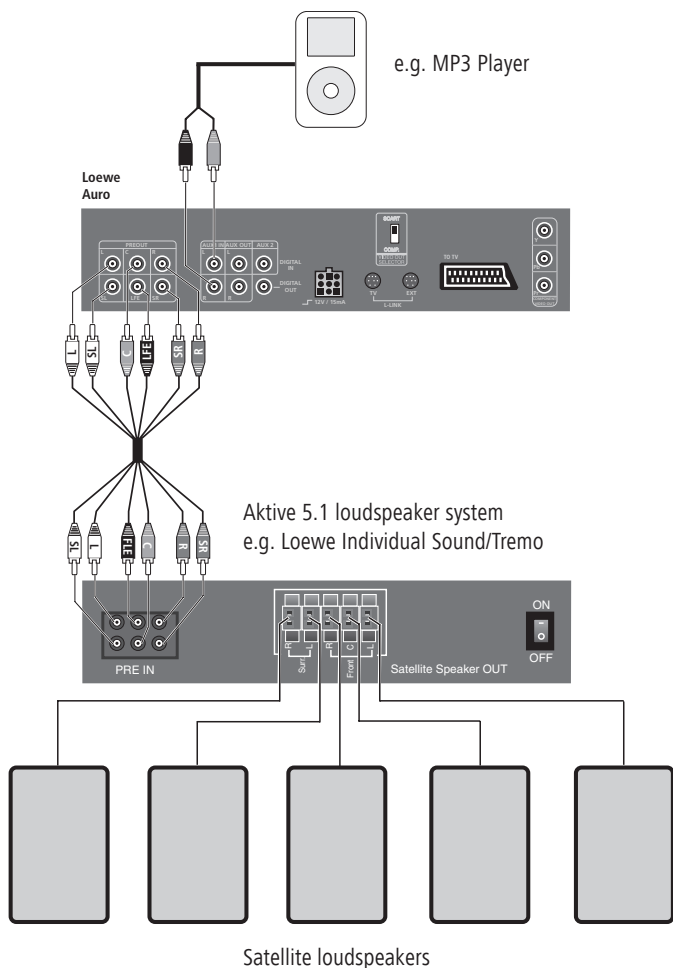

Connect the cables as shown in the graphic:

- Use a six-wire cinch cable to connect the PRE OUT outputs of the Auro to the corresponding inputs of the active 5.1 loudspeaker system.
- You can connect an additional external analogue source to the analogue audio input AUX 1 IN.
- Set the loudspeaker system to Auro as described on page 13.
- Set the limit frequency for the bass speaker on your active 5.1 loudspeaker system to at least 100 Hz.

Remote control

Inserting the batteries

To insert or change the batteries, press on the point indicated by an imprinted arrow. Push the battery compartment cover down and remove it. Insert batteries of the alkaline-manganese LR 03 (AAA) type and make sure the + and – poles are the right way round.

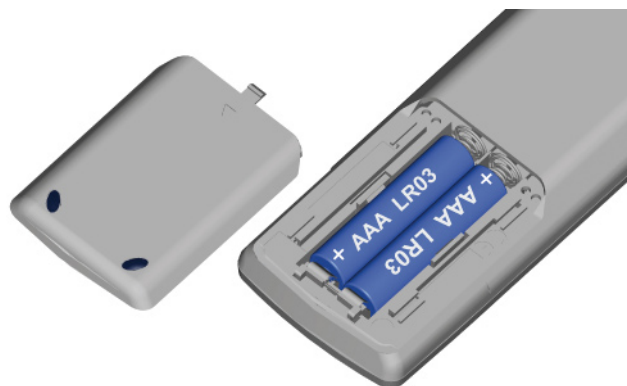

Then push the cover back on from below.

Note on disposing batteries



The batteries provided contain no harmful materials such as cadmium, lead or mercury. Regulations concerning used batteries stipulate that batteries may no longer be thrown out with the household rubbish. Deposit any used batteries free of charge into the designated collection containers set up at commercial businesses. You can dispose used batteries also at your dealer.

First installation

Switching on for the first time

Power mains

Connect the TV set to a 220-240V/50- 60 hertz power outlet.

Note: First, read section "About operation" on pg. 15/16 to find out about the basic operation of Auro.

 Press the button on the front of the device

or



set the remote control to DVD-Preceiver mode and switch on DVD/CD

or



press the button on the remote control briefly and switch on radio.

Auro is switched on, **DVD/CD** appears in the display. This indicates that the DVD/CD sub-unit is switched on.

Shortly afterwards, the message **READING** appears in the display. Now Auro tries to read the disc in the drive. **NO DISC** appears in the display if there is no disc in the drive.

Setting the language

First, set the desired language for the Auro menus. English is the default. Proceed as follows to set the language of your choice:

There is no disc in the drive and the drawer is closed.



Press the button.

The DVD menu is displayed.

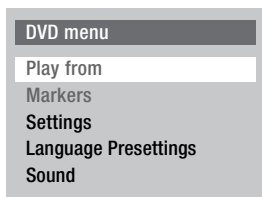

Go with **▼** to the item "Language Presettings".



Press **▶**.

The "Language Presettings" window opens:

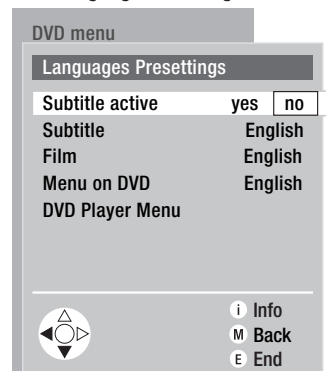

Go with **▼** to the item "DVD Player menu".



Press **▶**.

The "Language DVD Player Menu" window opens:



Go with **▼ ▲** to the language of your choice.

First installation



Press the button **OK**.

The selected language is then set as Auro's user interface language.



The DVD menu is closed when you press the **END** button.

Activate Digital Link

With Digital Link, Loewe TVs pass on the remote control signals to Auro via the Euro-AV connection. Digital Link is useful when you want to install Auro concealed, e.g. in a closed rack where it cannot be reached by the remote control signals.

Switching on Digital Link

Auro must be in standby (standby indicator lights red, display is dark). Hold the button  the device pressed for at least five seconds until the message **LINK** appears in the display.

Switching off Digital Link

Auro must be in standby (standby indicator lights red, display is dark). Hold the button  the device pressed for at least five seconds until the message **FRONT** appears in the display.

Switch over PAL/NTSC

Auro is set to the PAL TV norm at the factory. If your TV is set to another standard (NTSC), you have to adapt the Auro setting accordingly. There is no disc in the drive and the drawer is closed.

If Auro is switched on: keep the Pause button on the device



or on the remote control  pressed for five seconds.

NTSC, appears in the device display, Auro is then set to the NTSC TV standard.

In the same way, you can set the Auro to **AUTO** or **PAL**.



In the **AUTO** setting, Auro automatically detects whether a PAL or an NTSC-DVD is inserted and switches over to the respective standard.

Doing a reset

You can reset all settings in Auro to their original values with a Reset.

The state prior to initial installation (Factory Setting) is reinstated.

If Auro is in standby mode (red standby indicator lights) and the remote control is set to the DVD/CD mode:

1. Press the button  on the remote control and hold it down.
2. Also press the  button on the device and hold it down.
3. Keep both the buttons held down for at least 5 seconds.

Then, Auro switches on, the message **RESET** appears in the display. The sub-device **DVD/CD** is active.

All settings are therefore reset to their original values. You have to perform initial installation.

Switching over to Progressive Scan

With the Progressive Scan mode you get the highest possible picture quality without flickering in the "Component Video" operating mode. Set the "VIDEO OUT SELECTOR" switch on the back of Auro to the "COMP" position. If Auro is switched on: Keep the stop button (there is no disc in the drive and the drawer is closed. / no menu display) on the unit  pressed for five seconds.

P-SCAN ON, appears in the unit display so that Auro is switched to Progressive Scan mode.

In the same way you can set Auro to **P-SCAN OFF**.

First installation

Setting the loudspeaker system

The dialogs for selecting and setting your loudspeaker system are all in the "Speaker System" window.

Selecting the speaker system



There is no disc in the drive and the drawer is closed or an inserted DVD is in Stop mode.

The DVD menu is displayed.



Go to the item "Settings".



Press **▶**.

The "Settings" window opens.



Go to the item "Speaker System".



Press **▶**.

The "Speaker System" window opens.

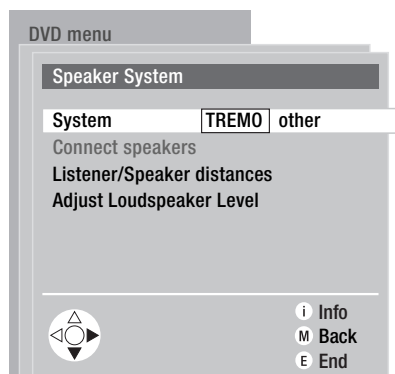

Select "Tremo" if you have connected 4 satellite speakers (also in Individual Sound).

If you use 2 or 4 Individual Sound standing speakers, select "other". This also applies for connecting an active speaker system or a passive system of another provider.



Press **◀ ▶** and select "TREMOR" or "other".

Connect speakers

Note: This dialog is omitted, if you have selected "Tremo" as the connected speaker system.

If you have selected "other" as a speaker system:



Go to the item "Connect speakers".



Press **▶**.

The "Connect speakers" window opens.

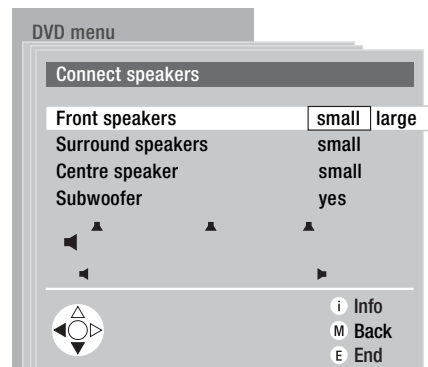

Specify whether you have connected large or small front speakers to Auro.

The Loewe Individual Sound S1 satellite speakers must be logged in as "small".

The Loewe Individual Sound L1 standing speakers must be logged in as "large".

In the graphic overview, you can check whether you have logged in your speakers correctly.



Go to "Surround speakers" and so on.

Note: Some speaker combinations cancel each other out.



Press the button.

The "Connect speakers" window is closed. You are back in the "Speaker System" window.

First installation

Entering the distance between speakers



Open the "Loudspeaker System" menu as described on page 13.

Go to the item "Listener/speaker Distances".



Press **▶**.

The "Listener/Speaker distances" window opens.

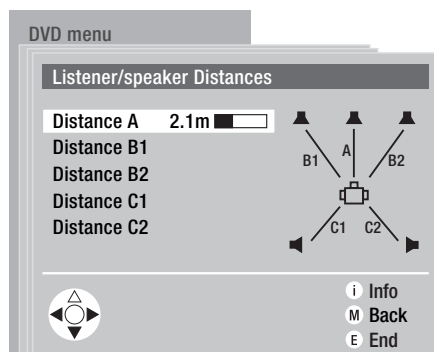

Set the right distance value A (distance listener from center loudspeaker). You can change the distance in steps of 0.3 m.



Go to "Distance B1" (distance of listener from left front speaker) and set the right distance here, too.



Do the same for all connected speakers. Press the button.

The "Listener/Speaker distances" window closes. You are back in the "Speaker System" window.

Adjust loudspeaker level

With this dialog, you can compensate differences in volume between the individual speakers. The basic volume of the speaker system should not be influenced with this function.



Take up your normal listening position.

Set normal volume.



Go to the "Adjust loudspeaker level" item in the "Speaker System" window.



Press **▶**.

The "Adjust loudspeaker level" window opens.

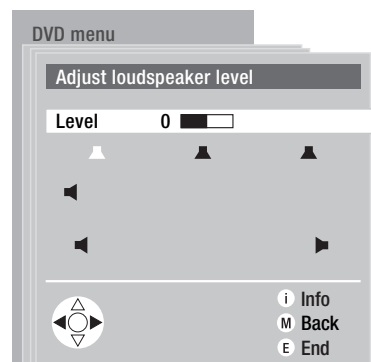

You hear a noise in turn from every single loudspeaker starting with the front left speaker. The speaker is highlighted in white in the overview (see the figure) whilst the noise is being emitted from it. You can reduce or increase the volume of this loudspeaker whilst the noise is being emitted from it. Listen to all the speakers once first. The perceived volume should have the same intensity from all speakers.



Is one loudspeaker quieter than the others? Then, increase the volume level of this speaker (**▶**).



Is one loudspeaker louder than the others? Then, reduce the volume level of this speaker (**◀**).

Repeat the procedure until you are hearing all the speakers at the same volume.

This completes the setting of your loudspeaker system. To close the DVD menu: Press the button **END**. See the section on audio functions (pg. 38).

About operation

Auro is a DVD-Preceiver. It covers the scope of functions of a DVD player ("DVD/CD") and a radio receiver ("Tuner") for medium wave (AM) and VHF (FM). Processing and transfer of the audio signals take place in a pre-amplifier with different decoders. This allows you to set various sound modes – depending on the format of the sound source (e.g. DVD, Tuner, TV ...).

You can switch between the sub-devices by either pressing the **Source** button on Auro or by making the appropriate setting on the remote control. When you switch over with the buttons on Auro, you must set the RC4A to the corresponding remote control mode. There is no need for this adaptation of the Auro and the remote control when you switch with the remote control. Therefore, we recommend you to switch between the sub-devices with the remote control.

When you select the operating mode with the buttons **RADIO** **TV** **PIP** **DVD**, the appropriate device is switched on unless it already was.

You can operate the various Loewe units with the RC4A remote control (see page 41).

Operation of the Auro with a DVD inserted is described in this chapter. Operation is performed with the remote control.

When you insert a DVD in Auro (see pg. 19), you can follow the description below on your remote control.

Activate the mode of the remote control

DVD Set the remote control to DVD Preceiver mode.

Inserting a disc

▲ Press the button on the device.

The disc drawer is opened, **OPEN** appears in the Auro display. Place the disc in the drawer with the labeled side up.

▲ Press the button on the device.





The drawer is closed.

The Auro display then changes to **READING**. The media type is displayed (the **DVD** symbol lights additionally for a DVD).

The intro start playing when you insert a DVD. Then, the DVD's own user interface is displayed (see pg. 18).

Basic functions

The basic functions are:

-  Start playback; button
-  Pause (single frame); button
-  Stop; button
-  Short key press: Go to beginning of chapter
Long key press: Search

▶ Play A message appears on the screen after calling a basic function. Auro therefore confirms that it has executed the called function, here, for example, after pressing the  for play.

Note: Even if the remote control is in the "RADIO" mode you can start playing a disc with the  button. The remote control then changes automatically to the "DISC" mode, Auro is switched over to the "DVD/CD" sub-device, and playback of the disc begins.

Function not possible If this message appears, you have pressed a button which currently has no function.









These messages are hidden automatically after 8 seconds. To hide it earlier: Press the button **END**.

User interface

Every operating mode (DVD, Audio CD, etc.) has its own menu bar and own menu.

Menu bar

Call the menu bar, for example, if you want to use the DVD beyond its basic functions. The DVD menu bar consists of eight elements. Each of these elements stands for a function. Call the menu bar with the **INFO** button:

	1/2	— Select title (see page 20).
	3/9	— Select chapter (see page 20).
	1 Deu	— Select sound format (see page 22).
	1 Eng	— Select subtitles (see page 26).
	1/3	— Camera position (see page 22).
	T	— Repeat (see page 23).
	x4	— Zoom (see page 23).
	Auto	— Sound mode (see page 41).

About operation

Change between the items in the menu bar with ▲ ▼. A white background inside an element means: this element is currently active (in the figure: "Select chapter"). All the operating steps you now perform relate to this element.

Functions which are currently unavailable are shown in gray in the menu bar (above, for example, "Select sound format").

To execute a function: Press the button **OK**.

If you change the sound format or the language of the subtitles with the menu bar, this change only applies for the inserted DVD. The presets from the DVD menu apply again when you insert another DVD.

To hide the menu bar: Press the button **END**. Press **INFO** again to get help with the individual elements.

Menu and window

Always call the DVD menu when you want to change the basic settings of your Auro (language, picture format, child lock, audio settings).

Press button.



The DVD menu is displayed:

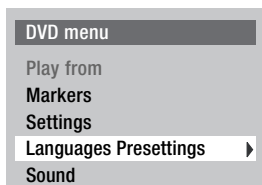

You will see the name of the menu ("DVD menu") at the top of the window. You see a selection of functions in the main part of the window. The selection bar shows you which function is selected ("Languages Presettings"). Functions which are not currently available are shown in gray ("Play from").

The arrow head on the right of the selection bar indicates that there is another window for the "Languages Presettings" function.



Open this window with ► or the **OK** button:

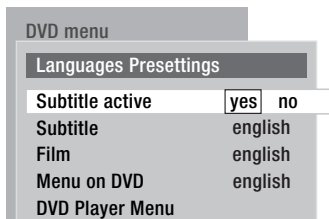

The "Subtitle active" function is marked. You can select between the options "yes" and "no". "yes" is selected in the graphic.

Possible operating steps are displayed in the bottom part of all windows of the DVD menu. In the window displayed here, you can:

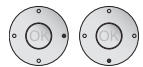

Press ► or ▼;



call the context help with the **INFO** button (see "Context help" on pg. 16);



close the current window "Languages Presettings" only with the **MENU** button to return to the higher menu level;



close all windows, i.e. the complete DVD menu, with the **END** button.

The structure of these operating instructions varies according to the operating situation.

Context help

Whenever you have marked a function in the user interface, the context help will give you an explanation of this function.



Show DVD menu with button.



Mark the "Languages Presettings" function.



Press the button **INFO**.

Context help is shown.

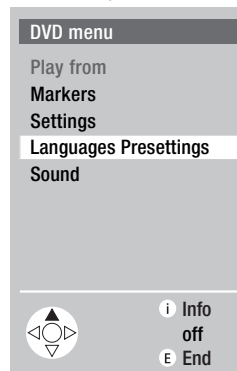

i Languages Presettings

In this menu, you can modify the default language settings (film, subtitle and DVD menu language). If these are already preset on the DVD, they will be set automatically when the DVD is inserted.

About operation

You can perform the following operating steps here as you can see in the bottom part of the window:



Change to the "Settings" function with **▲** to show the context help for "Settings".



Change to the "Sound" function with **▼** to show the context help for "Sound".



Hide the context help with **INFO**.



Hide the context help and DVD menu with **END**.

Title

A title is the main film content or the content of the accompanying feature or the music album. Each title has a title number enabling you to locate it easily.

Chapter

Chapters are sections of a film or a piece of music that are smaller than a title. A title consists of one or several chapters. Each chapter has a chapter number to enable you to locate the desired chapter. Depending on the disc, chapters may not be labeled.

Title Table

In the Title table you get an overview of the division of the disc.



Press the button **OK**.

Now the respective list of the inserted disk appears. You can select a title and start it with **OK**.

Title/Chapter Table	
Title 1	Chapter 1
Title 2	Chapter 2
	Chapter 3
	Chapter 4
	Chapter 5
	Chapter 6
	Chapter 7
	Chapter 8
	other ...

When calling the Title Table, the current chapter is always marked in the current title (here: Chapter 6 in Title 1).

You can move between the columns for titles and chapters with the arrows **◀** and **▶**. You can choose within a column with the arrows **▲** and **▼**. You can start the selected chapter or the selected title with the **OK** button.

To hide the Title/Chapter Table: Press button **END**.

Status display

The status display gives you information about the current state of Auro.



Press button **END**.

Status display is shown, here for example for a DVD. The structure of the status display differs according to the status of Auro.

Whilst playback is running:

Title	2/5
Chapter	2/14
Play time title	1:24:54
Total time title	1:45:21
DVD	▶ Play
■ ■ ■	Auto 5

The DVD status display contains the following data:

- current title, total number of titles
- current chapter, total number of chapters in the current title
- elapsed playing time of the current title (Play time title)
- total playing time of the current title (Total time title)
- type of medium loaded ("DVD")
- current drive status (Auro is switched to "Play")
- audio channels of the sound source (5 loudspeakers, no subwoofer), sound mode ("Auto") and number of actually controlled loudspeakers (5 loudspeakers)

If the Auro disk drive is in Stop mode (no playback after inserting a disc or after ending playback):

Total Titles	5
DVD	■ Stop
■ ■ ■	Auto 5

The DVD status display then contains the following data:

- total number of titles (Total Titles)
- type of medium loaded ("DVD")
- current drive status (Auro is switched to "Stop")
- same audio data as during playback

The status display is hidden automatically after 8 seconds. To hide it earlier: Press the button **END**.

About operation

User interface of the inserted DVD

Two user interfaces are available for operating DVDs: the Auro interface and the DVD interface itself. Both interfaces are totally independent of each other.

The DVD's own interface is visible after inserting the DVD and running the intro with which most DVDs are equipped.

You can call the DVD's own interface at any time during DVD playback.



Select Disc Menu with **TEXT**.

Sleep timer

With the sleep timer you can set the Auro to switch off automatically after a set time.



Press the button **Timer**.

SLEEP 120 appears in the Auro display. The sleep timer is switched on, Auro will switch off automatically after 2 hours.

You can change the time for automatic switch-off by repeatedly pressing.

The **SLEEP** symbol lights up in the display while the sleep timer is active.

To switch off the sleep timer:



Press the button **Timer**.

Press the button repeatedly until **SLEEP OFF** appears in the Auro display. This switches the sleep timer back off.

Note: The sleep timer function is also available in tuner mode.

Numeric input

A one or several digit number has to be entered for some functions. The following rules apply here:

one digit number

- either keep numeric button pressed for one second, then, this number is sent to Auro or
- press the numeric key briefly; the number is transferred to Auro after two seconds.

several digit number

- press the respective numeric buttons briefly.

Automatic functions

Resume

When you interrupt playback of a DVD, Auro remembers where. When you switch Auro back on and no other disc has been inserted in the meantime, playback continues at the point where it was interrupted.

Screen saver

The screen saver switches on when playback of a DVD is interrupted for five minutes. The background picture is dimmed.

Change to standby mode

When the screen saver is active and no operation takes place for 15 minutes, Auro automatically switches to standby mode.

Five seconds to save

When you have switched Auro off, it cannot be switched back on again for five seconds. Auro needs these five seconds to save the current settings after switching off.

DVD



DVDs (Digital Versatile Disc) are recognizable from this logo.

Inserting a disc

- Press the button on the device.

The disc drawer is opened, **OPEN** appears in the Auro display. Place the disc in the drawer with the labeled side up.

- Press the button on the device.

The drawer is closed.

The Auro display then changes to **READING**. The media type is displayed (the **DVD** symbol lights additionally for a DVD).

The intro start playing when you insert a DVD. Then, the DVD's own user interface is displayed (see pg. 18).

Basic functions

Menu and window

Always call the DVD menu, for example, when you want to change the basic settings of your Auro (language, picture format, parental lock, audio settings).

- Press button.
DVD menu is displayed (see page 16).

Menu bar

Call the menu bar, for example, if you want to use the DVD beyond its basic functions. The DVD menu bar consists of eight elements. Each of these elements stands for a function. Call the menu bar with the button during playback (see page 15).

Start playback

- Press button on remote control
- or button on Auro.

Message:

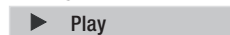

Playback starts.

Select title

- Press the **green** button.

or:

- Press the button **INFO**.

- Menu bar is displayed.
Go to the element "Select title".

T 1/2

- Select the desired title.

- Press the button **OK**. Auro goes to the beginning of the selected title.

- Press button to hide menu bar.

or:

- Press the button **OK**.

Title/Chapter Table is displayed:

Title/Chapter Table	
Title 1	Chapter 1
Title 2	Chapter 2
	Chapter 3
	Chapter 4
	Chapter 5
	Chapter 6
	Chapter 7
	Chapter 8
	other ...

- Press **←** once.

- This takes you from the "Chapter" section to the "Title" section.
Select the desired title.

- Press the button **OK**. Auro goes to the beginning of the selected title.

To close the Title/Chapter table: Press button .

DVD

Select chapter

Chapter forward or back



Select chapter.

Message:

Chapter 3 (of Title 2)

If you have pressed **▲** or "P+":

Playback starts at the beginning of the next chapter.

If you have pressed **▼** or "P-":

Playback starts at the beginning of the current chapter. If you press twice in quick succession, you go to the beginning of the previous chapter.

or:



Press button on the remote control



or button on Auro.

Message:

Chapter 3 (of Title 2)

Playback starts at the beginning of the next chapter.



Press button on the remote control



or button on Auro.

Playback starts at the beginning of the current chapter. If you press the button twice in quick succession, you go to the beginning of the previous chapter.

or:



Enter the number of the desired chapter with the numeric buttons (for numeric inputs, see pg. 18).

Message:

Chapter 12 (of Title 2)

Playback starts at the beginning of the selected chapter.

or:



Press the button **OK**.

Title/Chapter Table is displayed:

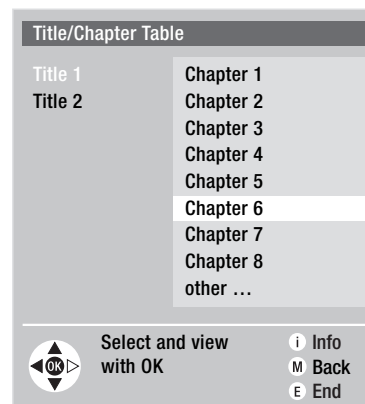

Now the respective table of the inserted disk appears. You can select a title here and start it with **OK**. When calling the Title table the current chapter in the current title is always marked (here: Chapter 6 of title 1).

You can move between the columns for titles and chapters with the arrows **◀** and **▶**. You can choose within a column with the arrows **▲** and **▼**. You can start the selected chapter or selected title with the **OK** button.

To close the Title/Chapter table: Press button **END**.

or:



Select disk menu with **TEXT**.

This takes you to the DVD's own user interface (see page 18) where you can select the desired chapter mostly.

See page 40 for audio functions.

DVD

Search

Note: The sound is off while the search is running.



Press the button long,

or:



Press the button **▶**.

Playback runs forward at double speed, the following message appears:

▶▶ Search x2

Search in reverse direction:



Press the button long,

or:



Press the button **◀**.



Playback runs in reverse at double speed, the following message appears:

◀◀ Search x2

Change the search speed:

The following speed steps are available in both forward and reverse directions:

x2, x4, x16, x100.

Change by repeatedly short pressing button  button (or: **▶**) or button  (or: **◀**).

End search:



Press the button.

Playback continues at normal speed.

Pause (single frame)



Press button on the remote control



or button on Auro.

DVD picture freezes, the Pause menu appears in the foreground, the "Pause" option is selected:

Single Frame | **Pause** | next
Slow Motion

Call single frames:



When you press the button again you will see the next single frame in forward direction.

Note: You can hide the Pause menu if you wish (button .

or:



Go to the "next" option with **▶**.

The next single frame is called after one second, the "Pause" option is selected again.

End the "Pause (Single Frame)" function:



Press button on the remote control



or button on Auro.

Playback continues at normal speed.

Slow motion: See page 25.

Interrupting playback



Press the button.

The standard screen appears with the message:

|| ■ Stop

Playback is interrupted.

If you now press the  button, playback continues at the point where it was interrupted.

Ending playback



Press button.

The standard screen appears with the message:

|| ■ Stop

Press button again.

The following message appears:

■ Stop

Playback is ended.





If you now press the  button, playback starts at the beginning of the disc.

DVD

Extended functions

Selecting sound format

With these functions, you can select another sound format on the DVD (if several sound formats are available on the DVD).

-  Press the button.
-  Menu bar is displayed.
Go to the "Select sound format" element with ▲ ▼ .
-  Select the desired sound format with ◀ ▶ .
-  Press the button **OK** . This changes the sound format.
-  Press button to hide menu bar.

Sound format

All three features of the sound format are displayed in the menu bar:

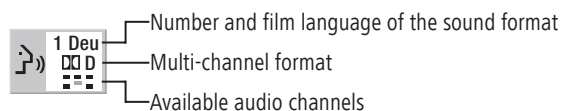

In our example:

- Number of the sound format: 1
- Film language of the sound format: German
- Multi-channel format: Dolby Digital®
- Available audio channels: 5.0 (no subwoofer)



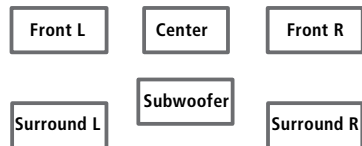



To display the audio channels:







If a channel is shown grey, it is not available in the selected sound format.

Subtitles

Note: This function is only available, if the DVD is equipped accordingly.

-  Press the button.
-  Menu bar is displayed.
Go to element "Select subtitles":
 off
-  Select the desired language.
-  Press the **OK** button. The subtitles are displayed in the selected language of the film.
-  Press button to hide menu bar.

End "Subtitle" function:

-  Call menu bar and activate the "Subtitle" element.
-  Select "off" option:
 off
-  Press the button **OK** . This switches off the subtitles.
-  Press button to hide menu bar.

Camera position

Note: This function is only available, if the DVD is equipped accordingly.

If a DVD is inserted which contains chapters with different camera positions, the  symbol lights up in the display. This symbol flashes when such a chapter is playing. The "Camera position" element of the menu bar then appears on the screen:



DVD

You can change the camera position while this element is displayed.
If you want to change the camera position:



Select alternative camera position.



Press the button **OK**.

Playback continues from the selected camera position.

Change the camera position later:



Press the button **red**.

Select alternative camera position by repeatedly pressing the **red** button.



Press the button **red**.

Playback continues from the selected camera position.

End "Camera position" function:

The function ends when the appropriate equipped section on the DVD (chapter, chapter sequence) ends.

or:



Press the button.



Menüleiste wird eingeblendet.
Gehen Sie zum Element Kameraposition:



Alternative Kameraposition wählen:



Press the button **OK**.
Playback continues from the selected camera position.



Press button to hide menu bar.

Repeat

You can repeat a chapter, a title or a freely definable passage (A-B).

Repeat a title or a chapter



Press the button.

or:



Press the button.



Menu bar is displayed.
Go to element "Repeat":



Select the setting "T" (for title) or "C" (for chapter) with ◀ ▶.



Press the button **OK**. The current title or current chapter is repeated until you end the function.



Press button to hide menu bar.

Repeat A-B

Use this function, if you want to repeat a passage with any starting point (A) and any end point (B).

While DVD is playing:



Press the button to mark starting point A.

Menu bar is displayed, in the "Repeat" element you will see:



Press the button to mark end point B.

In the "Repeat" element in the menu bar you will see:



The passage marked by A and B is repeated.

End "Repeat title / chapter or Repeat A-B" function:

Select the "off" setting in the "Repeat" element:



Press the button **OK**. This ends the "Repeat" function.



Press button to hide menu bar.

Zoom (magnify image)



Select Zoom.
Press the **yellow** button.

Menu bar is displayed, "Zoom" element is active:



DVD



Select the desired zoom factor ("x4" or "x16").



Press the button **OK**.

The central section of the whole image is magnified by the set value. Menu bar is hidden, "Zoom" display appears:



To move the magnified image section over the whole image:



Press the direction arrows.

End "Zoom" function:

Is Zoom still selected?



Press the **yellow** button.



Menu bar is displayed, "Zoom" element is active:
Go to the "off" setting with ◀ ▶.



Press the button **OK**. This ends the "Zoom" function. You see the whole image again.



Press button to hide menu bar.

Play from ...

With this function you can specify a time on the DVD at which playback is to resume.



Press the button.



The DVD menu is displayed.
Go to the item "Play from ...".



Enter the desired time with the numeric buttons.



Press the button **OK**. The menu is closed and playback resumes at the desired time.

Using markers

Set markers to identify any positions on the DVD. You can then resume playing at these markers.

You can set up to nine markers on every DVD. These markers only apply for the current playback.



Press the **blue** button.

The following message appears on the screen:

Marker 1/9 set

This sets the first of nine possible markers.

Set other markers:



Press the **blue** button a second time.

The following message appears on the screen:

Marker 2/9 set

This sets the second of nine possible markers.

Call marker(s):



Press the button.



Menu is displayed.

Go to the "Markers" entry and press ▶.

DVD menu

Markers

Search

1 2

Single delete

Delete all



Go to number "2", for example.



Press the button **OK**.

The DVD starts playing at marker 2.

You can delete single markers or all markers at once with the functions "Single delete" and "Delete all".

DVD

Slow motion

Note: The sound is off while slow motion is running.

 Press the button.

DVD picture freezes, the Pause menu appears in the foreground, the "Pause" option is selected:

Single Frame Pause next
Slow Motion



Go to the "Slow Motion" function with .

The "Slow Motion" item opens, the "Pause" option is selected:

Single Frame
Slow Motion -1/2 -1/4 -1/8 -1/16 Pause 1/16 1/8 1/4

Select the desired speed step (minus values such as "-1/16" or "-1/8" for reverse slow motion).

Playback continues at the selected slow motion speed, for example at half the normal playback speed when "1/2" is selected.

The Slow Motion menu is hidden after about 8 seconds. You can show it again at any time by pressing the  button.

End "Slow Motion" function:

 Press the button.

Playback continues at normal speed.

Basic settings

The basic settings of Auro can be changed in the DVD menu at any time. There is no disc in the drive and the drawer is closed.

Settings

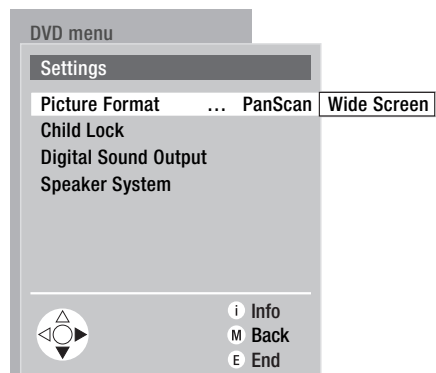

Picture Format

Note: "Picture Format" may be shown in gray, i.e. unavailable. In this case, interrupt the DVD playback first (button ) or remove the disk and close the drawer.



Select the desired picture format:

"Wide Screen" is defaulted for a wide screen TV (screen format 16:9).

If you have a TV with the 4:3 screen format, choose between 1) "Letterbox" for a picture in "wide format" with black bars at top and bottom or

2) "PanScan" for a picture of full height with cut-off sides. This switches from Auro to the picture format you have selected.

Note: This function is only available, if the DVD is equipped accordingly.

DVD

Setting Digital Sound Output

Note: This section only concerns you if you use the digital audio output of Auro.



Change from the "Settings" window to the "Digital Sound Output" window in the DVD menu:

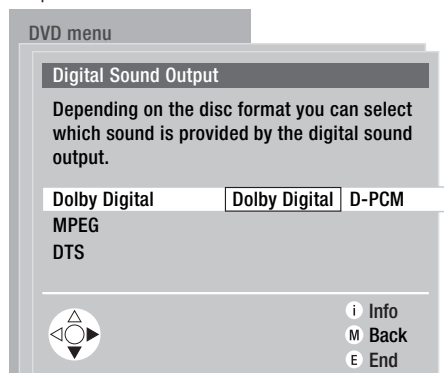

Select the appropriate settings:

- for "Dolby Digital": Dolby Digital – D-PCM
- for "MPEG": MPEG – D-PCM
- for "DTS": on - off

Note: "D-PCM" is a digital stereo signal created from the original signal.

Languages Presettings

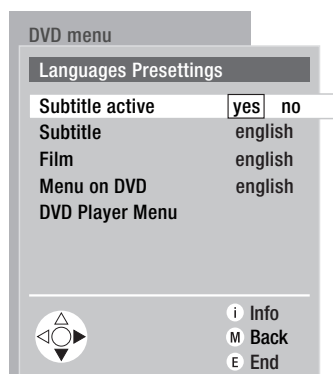

In the "Languages Presettings" sub-window of the DVD menu, you can define basic settings for:

- subtitles

- film language
- language of the user interface of the inserted DVD
- language of the Auro user interface

Subtitle active

You can select between the options "yes" and "no".

If "yes" is selected the subtitles are shown in the set subtitle language if these are available on the disc.

Subtitle language

If a DVD is inserted, the subtitles are displayed in the selected language, if this is available on the DVD and "Subtitle active" is set to "yes". If the selected language is not available on the DVD, the subtitles are played in the first subtitle language on the DVD.

Note: You can select a language for the subtitles for the respective loaded DVD with the "Subtitles" function (see pg. 22) – regardless of the basic setting made here.

Dubbing language (Film)

If a DVD is loaded, the sound is played in the selected language, if it is available on the DVD. If not, the sound is played in the first sound format language on the DVD.

Note: You can select a dubbing language for the respective loaded DVD with the "Select sound format" function (see pg. 22) – regardless of the basic setting made here.

Menu on DVD

Select the desired language of the user interface of the inserted DVD (see pg 18).

DVD-Player menu

Select the desired language of the Auro user interface; see also the detailed description on page 11.

Special features of DVD Audio



Discs in the DVD Audio format are recognizable by this symbol. DVD Audio is a high-resolution multi-channel sound format and is therefore superior in sound quality to the Audio CD and MP3 formats.

Discs in DVD Audio format often contain stills. These stills are freely selectable on some DVD Audio discs. Therefore, the DVD menu bar (see pg. 15; call with button) contains the "Select picture" element in place of the "Camera position" element for DVD Audio: 3/24 .

If the numbers in this menu bar element are shown in gray, you cannot select the stills.

Audio-CD

Status display

When you insert an audio CD and there is an L-link to the TV set, the TV picture is switched off automatically. To show the status display, press the button  (it takes a few seconds for the TV picture to appear).

Note: If there is no L-link to the TV set you have to select the Euro-AV socket of the Auro on the TV set to display the status display on the TV set.

Here is an example of the status display for an audio CD:

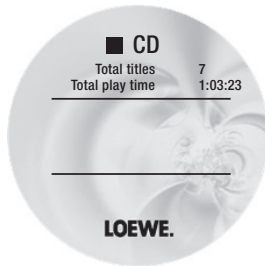







Hide status display:

 Press the button.

The status display is closed and the TV set switched off (only with L-link).

Menu bar

 Press the button. The menu bar is displayed.

 2/9	—Select title
 21:46	—Play from ...
 off	—Random order
 off	—Repeat
 Auto	—Sound mode

Note: When the menu bar is displayed, the CD status information is hidden. Then, you only see the background picture.

Select title



Press the button **OK**.



Select titles with  .



You can start the selected title with **OK**.



Press the button to close the Title table.

Play from ...



Press the button.



Menu bar is displayed.
Select the element "Play from ...".

The display changes in the "Play from ..." element:



Enter the desired time with the numeric buttons.



Press the button **OK**.

Playback starts at the desired time.

Audio-CD

CD Random

When you switch this function on, the titles of your VCD/SVCD are played in random order.



Press the button.



Menu bar is displayed.

Go to the element "CD Random":



Select the "on" option.



Press the button **OK**.

From now on, the titles on your disc are played in random order.

RANDOM lights up in the Auro display



Press button to hide menu bar.

End "CD Random" function:



Go to the "Random order" menu bar item and select the option "off".



Press the button **OK**. From now on, the titles on your disc are played in normal order.



Press button to hide menu bar.

Repeat

Accordingly DVD (page 23). Here the options "T" title, "all" and "off" can be selected.

Repeat A-B

according to the DVD (pg. 23).

Audio-CDs with CD-Text

Some Audio-CDs are equipped with CD-Text. Auro can process CD-Text. CD-Text is recognizable by the name of the artist, the name of the CD, or the name of the current title appearing in the Auro display depending on the situation.

Text display



Press **yellow coloured key**.

With the yellow coloured key you display the artist or the title alternately in the message line of the Auro display. If the text is too long it is shown as a moving text.

Audio-CD

Title Programming

With the "Title Programming" function, you can play the titles on your disk in a freely selectable order.



Press the button.



The "Title Programming/Custom File" window is displayed. Select the item "Title":

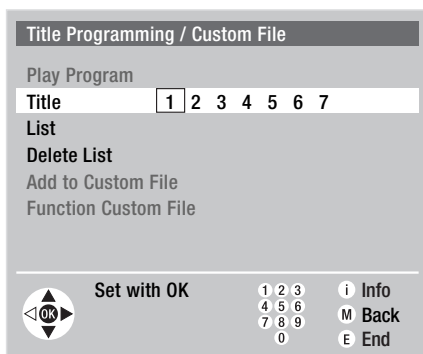

If your program is to begin with title 3:



Go to title 3 with **▶**.
only for CD: the selected title is played.



Press the button **OK**.

Title "3" appears in the "List" line. Your programmed title sequence begins with this title.
Add other titles to your list in the same way.

If you want to insert a title at any point in your list:

You have compiled the following list:

Title	1	2	3	4	5	6	7
List	3	7	6	5			



You want to insert title 4 at the third place in the list.
Go to the "List" item with **▼**.



Go to title 7 (before the insertion position) with **◀**.

Title	1	2	3	4	5	6	7
List	3	7	6	5			



Go to the "Title" item with **▲**.

Title 7 is highlighted in blue in the "List" item.

Title	1	2	3	4	5	6	7
List	3	7	6	5			



Go to title 4 with **◀**.



Press the button **OK**.

This inserts title 4 at third place in the list.

Title	1	2	3	4	5	6	7
List	3	7	4	6	5		

If you want to delete a title from the list:



Go to the "List" item with **▼**.



Go to the title you want to delete with **◀ ▶**.



Press the button **OK**.

This deletes the title from the list.

If you want to play your program.



Go to the "Play Program" item with **▲**.



Press the button **OK**.

Auro begins playing your program.

End playback of your program:



Press the button twice.

Your program is not played the next time playback starts.

If you want to delete the whole list:



Go to the "List" item with **▼**.



Press the button **OK**.

This deletes the list.

Audio-CD

Save program (Custom File)

A program you have compiled with "Title Programming" can be saved in a special memory in the Auro, Custom File, and played again and again – even when you have inserted other discs in the meantime. The CD then appears as if it only contained the program saved in the Custom File.

This function is available for Audio-CDs and CDs with MPEG data. You can save a program for a maximum of 10 discs in the Custom File. Then, you can save other discs in the Custom File, but the respective first program in the Custom File is deleted to make the necessary space in the memory.

Hereinafter, we assume that you have determined a program for the inserted disc (see pg. 30) and want to save this program in the Custom File:



Select the "Add to Custom File" item in the "Title Programming/Custom File" menu with ▾.

"(00/10)" is added to the entry, i. e. 0 of 10 memory slots are occupied at present.

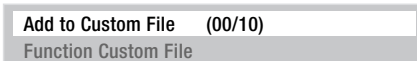

Press the button **OK**.

This saves the program of the inserted disc as the first of a maximum of 10 programs in the Custom File. The display changes to "Delete from Custom File". At the same time, the "Function Custom File" item is activated, the "on" option is defaulted:



"Function Custom File – on" means: When you start a disk for which a program is saved in the Custom File, this program is played in place of the whole disc.

To switch on/off the Custom File function:

Go to the item "Function Custom File" with ▾
Select the "on" or "off" option.

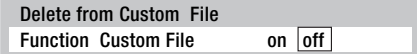

Press the button.

To delete the inserted disk from the Custom File:

Select the item "Delete from Custom File".



Press the button **OK**.

This deletes the inserted disk from the Custom File. The line changes.

MP3 and JPEG

Status display

When you insert an MP3 CD and there is an L-link to the TV set, the TV picture is switched off automatically. To show the status display, press the button  (it takes a few seconds for the TV picture to appear).

Note: If there is no L-link to the TV set you have to select the Euro-AV socket of the Auro on the TV set to display the status display on the TV set.

Here is an example of the status display for an MP3-CD:

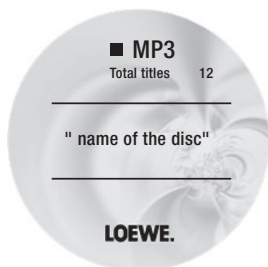

Press the button.

The status display is closed and the TV set switched off (only with L-link).

MP3 and JPEG mixed

Operation of MP3 and JPEG data is very similar. In mixed CDs, Auro only initially provides the MP3 data. You have to switch over the data format to be able to use the JPEG data. The Folder/Title Table must be displayed in order to do this (button **OK**). Press the  button with the Folder/Title Table displayed to switch back and forth between MP3 and JPEG data.

CD Text

Both with MP3 and JPEG-CDs, the name of the disc and the name of the current title are shown in the Auro display – similar to Audio-CDs with CD-Text. There is no equivalent of the artist's name on Audio-CDs for MP3 and JPEG-CDs. Text display same as Audio CD (see page 29).

Menu bar MP3

If MP3 data are being processed, the menu bar is the same as that for Audio-CD (pg. 28).

Note: The following special features apply for MPEG in comparison with Audio-CDs:

- "Repeat A-B" is not available
- with "Repeat all" only the current folder (see pg. 33) is repeated
- "CD Random" only works on the last folder

Menu bar JPEG

If you have selected JPEG data, you get the JPEG menu bar:

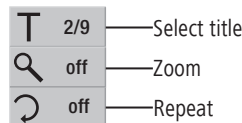

Select title

according to Audio CD (pg. 28).

Zoom

according to the DVD (pg. 23/24).

Repeat

according to Audio-CD, "Repeat title/all" (pg. 29); for JPEG only the options "all" and "off" are available.

With "Repeat all" you can select a kind of slide show in which all pictures are shown for eight seconds each.

MP3 and JPEG

Folder/Title Table

You can show the Folder/Title Table with the **OK** button. Operation of MP3 and JPEG data is identical.

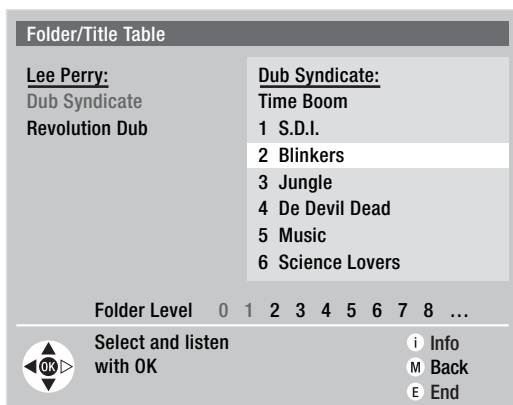

- In the graphic, we assume that the inserted medium only contains MP3 data; the data are stored in several folder levels.
- The name of the medium ("Lee Perry") and the name of the selected folder ("Dub Syndicate") are underlined.
- The titles of all folders are automatically numbered with one number range for all folderlevels.
- Folders are entered in the list without leading numbers (left: "Dub Syndicate" and "Revolution Dub"; right "Time Boom").
- When a folder is marked, you can move to lower folder levels with the "right" arrow and to higher folder levels with the "left" arrow.
- In the "Folder Level" line, the two folder levels are marked which are currently displayed in the columns left ("0") and right ("1").

Title Programming/Custom File

(only MP3)

according to Audio-CD (see pg. 30).

Kodak Picture CD

Photos are stored in JPEG format on a Kodak Picture CD. Auro can display these photos on the TV set as described above.

Rotate JPEG pictures



If you want to rotate a JPEG picture (on JPEG-CD or Kodak Picture CD):

Press ◀ ▶.

With ◀ the picture is rotated clockwise, with ▶ anticlockwise.

Child Lock

With the child lock you can prevent your children from playing unsuitable DVDs. A child lock is not available for other kinds of media (Audio-CD, MPEG, JPEG). With appropriately equipped DVDs, it is even possible to have certain chapters (scenes) replaced by alternative scenes which are suitable for children. Auro detects the chapter requiring protection (the appropriate scene). Depending on how you have set the child lock, the original scene is played or an alternative scene not requiring censorship. The censorship evaluation differs from country to country. This evaluation is therefore linked to the setting under "Location of Set" (country).

Activating the child lock for the first time

Determine your personal identification number (PIN)

To activate the child lock, you have to enter a four-digit PIN first.



Press the button.



The DVD menu is displayed.
Go to the "Settings" item in the DVD menu.



Press the button ►.



The "Settings" window opens.
Go to the "Child Lock" item.



Press the button ►.

The "Child Lock" window is displayed with the prompt to enter a four-digit PIN.

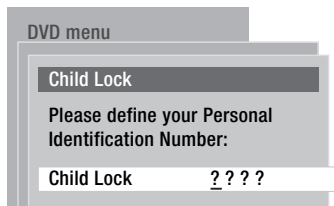

Enter your PIN with the numeric buttons.



When you have entered the fourth digit, the text "Please remember your PIN before continuing with **OK!**".
Take this advice.
Press the button **OK**.

This sets your PIN.

Prompting the location of the set

The prompt "Location of Set" now appears, if you are activating the child lock for the first time.



Go to the country in which the set is being used with ◀.



Press the button **OK**.

The value entered under "Lock level" is evaluated according to the rules applicable in the selected country.
You can change this setting at any time.

Note: If you have forgotten your PIN: Auro always accepts the digit sequence "3001" as a PIN.
With the "Change PIN" function, you can set a different personal code number at any time.

Child Lock

Using the child lock

The "Child Lock" window has the following structure on DVDs:



Lock level



Go to the "Lock level" item in the "Child Lock" window.

The selection bar opens, the "off" option is activated:

Lock level general 1 2 3 4 5 6 7 8 **off**



Go to the option of your choice with **▶** or enter the security level with the numeric buttons, see "Different options" below.



Press the button **OK**.

This sets the child lock to the lock level you have selected.

Different options:

- "off" option: Child lock is switched off. No PIN code is prompted (unless the DVD is locked; see below).
- Option "1" to "8": The least scenes (chapters) are locked in option "1". In option "8", more harmless scenes are also locked or replaced by alternatives.
- "general" option: The secret code is prompted before playing for all DVDs.

Changing the PIN

1. Go to the item "Change PIN".
2. Enter a new PIN of your choice with the numeric buttons.
3. This changes the PIN.
4. Please remember your new PIN!

Deleting the PIN

Deletion of the PIN deactivates the child lock.

1. Go to the item "Delete PIN".
2. Press the button **OK**.
3. This deletes your PIN and deactivates the child lock.

Location of Set

You can change the "Device location" setting you made the first time you activated the child lock with this function (see pg. 34).

Lock disc/unlock disc

If you want to have the PIN prompted before playing certain DVDs:

1. Go to the item "Lock disc".
The entry gets the suffix "(0/20)": **Lock disc** **(0/20)**
No DVD is locked yet ("0"); you can lock a maximum 20 DVDs.
2. Press the button **OK**.
This locks the loaded DVD
The text changes: **Unlock disc**
3. If you now press the **OK** button, the disc is unlocked again; the text changes back to "Lock disc (0/20)".

Tuner

Initial installation FM

The sub-device DVD/CD is active when you switch on Auro for the first time. You have to change to the radio first:

 Press the button long.

The "Tuner" is active on the Auro, the FM wavelength is switched on.

In the Auro display, **IST INST** and **WAIT**. Auro searches the FM range for stations with adequate reception quality and enters these stations in a list. This process may last a few minutes. At the end of this process, the first station in this list is played. The number and name of this station are shown in the display. Auro can be operated normally from now on.

If the played station has an RDS name, the RDS name will be displayed.

RDS lights up additionally in the display.

First installation AM

Change to the AM wavelength:

 Press the button or

press the button on the unit until "TUNER" appears in the display.



The tuner changes to the AM wavelength. Here, too, first installation is carried out as for the FM.

Selecting station/program place

Regardless of whether or not the station table is displayed, you can select stations in the following way:



Press **P+** for station forward or **P-** for station backwards.

or:



Enter the number of the desired station with the numeric keys.

Back to the previously played station:



Press the **yellow** button.

Station table

Note: This function is only available, if Auro and the TV set are connected by an L-Link.

In both wavelengths, you get the station table after pressing the **OK** button, here, an example for the FM wavelength:

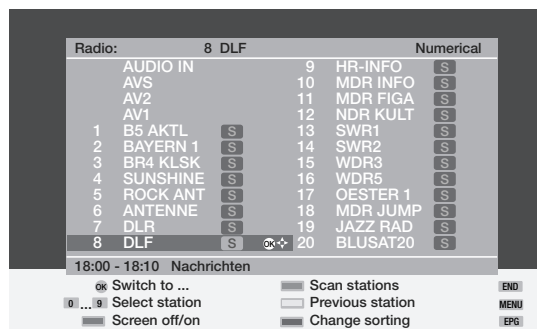

Radio:	8 DLF		Numerical	
	AUDIO IN		9	HR-INFO S
	AVS		10	MDR INFO S
	AV2		11	MDR FIGA S
	AV1		12	NDR KULT S
1	B5 AKTL S		13	SWR1 S
2	BAYERN 1 S		14	SWR2 S
3	BR4 KLSK S		15	WDR3 S
4	SUNSHINE S		16	WDR5 S
5	ROCK ANT S		17	OESTER 1 S
6	ANTENNE S		18	MDR JUMP S
7	DLR S		19	JAZZ RAD S
8	DLF S		20	BLUSAT20 S

18:00 - 18:10 Nachrichten

Switch to ... Scan stations END
Select station Previous station MENU
Screen off/on Change sorting EPS

The FM-Radio station table holds a maximum of 36 stations. In our example, 29 stations have been found in the initial installation and entered in the station table.

Stations with RDS names are placed at the beginning of the list followed by the stations which do not transmit an RDS name. These transmitters are listed with their reception frequency.

The station table for AM holds a maximum of 24 stations.

You can hide the station table with the button .

Automatic station search

You can create a new list of stations and have it entered in the station table at any time separately for every wavelength. All the previously saved stations are then deleted of course.

 Press the button on the device for at least 5 seconds.

You will see the frequency in the Auro display. If a station is found it will dwell longer on this frequency. A new station table is created. At the end of this process, the first station of the newly created station table is played. Auro can be operated normally from now on.

Tuner

Individual resorting

You can change the layout of the stations/program places at any time. You can place your favorite station at program place 1, for example. Please note that the station that was previously at program place 1 will be lost.



Select the station which is also to be stored at the new program place (program place is copied).



Press the button on the device.

MEMORY lights up in the Auro display.



Select the number of the desired programme place with P+/- on the remote control. **MEMORY** lights up and the number for the new programme place flashes.



Press the button on the device.

This places this station at the newly selected program place, **MEMORY** is hidden.

Switching tuner display





Press the button repeatedly. Either the RDS name or the station frequency appears in the message line in the Auro display (see page 5).

Manual station search



Press one of these buttons long.

The tuner searches for the next station with adequate reception quality, with  forwards, with  in reverse. As soon as such a station is found, the search ends and the found station is played. **TUNED** lights in the display.



Fine tuning

Note: This function is only available for the FM range.

If the reception quality of the current station is unsatisfactory, you can adapt the frequency in small steps.



Press one of these buttons short.

The frequency set on the tuner is changed in small steps (0.05 MHz), with  forwards, with  in reverse. Observe **TUNED** in the display. When it is alight, the reception power is adequate. When it is hidden, the reception is too weak for satisfactory playback.

Mono/Stereo switching

In the case of poor reception in the FM waveband, you can improve the listening quality by switching over to mono:



Press the button.

The received station is played in mono, **STEREO** is hidden in the Auro display.

Switch stereo back on:



Press the button.

Playback is in stereo, **STEREO** lights in the display.

Tuner

Programming the station manually

Set the desired frequency with the functions "Manual station search" and "Fine tuning" if necessary.

 Press the button on the device short.

The Auro display offers the possibility of storing this frequency at the next free program place (e.g. number 30 flashes); if all program places are occupied, the first program place is offered (digit 1 flashes). Additionally, **MEMORY** lights.

If you want to accept the suggested program place:

Press the button on the device.



The frequency you specify is then assigned to the suggested program place.

If you want to assign a different program place to the one suggested:



Select the number of the desired programme place with P+/- on the remote control. **MEMORY** lights up and the number for the new programme place flashes.



Press the button on the device.

This assigns the frequency you have set to the program place you have selected, **MEMORY** is hidden.

Audio functions

The audio functions act centrally on the whole audio system regardless of whether "DVD/CD" or "Tuner" is switched on as a sub-device or whether TV sound is played or the sound of another device connected to Auro.

Volume



The volume is controlled by **V-/V+** on the remote control.



With the "Sound off/on" button, you can mute the speakers or switch them back on by pressing this button.

Treble and bass

Treble and bass can be set in two ways: in the Sound menu in the Auro display or in the DVD menu.

by the Sound menu in the device display



Press the button (repeatedly).

(SOUND) appears in the Auro display. This opens the display-based Sound menu.

Press **▲** once.



(BASS 0) appears in the display. ("0" is only an example. The value set at Auro is displayed.)

With **◀ ▶**, you can change the settings for the low frequencies in a value range of -12 to +12.



To change the settings for high frequencies:

Press **▲** again.



(TREB 0) appears in the display. (Here, too, "0" is only an example.)

With **◀ ▶**, you can change the settings for the low frequencies in a value range of -12 to +12.



See also page 39 "Night mode".

Audio functions

with the DVD menu:



Press the button.



The DVD menu is displayed.
Go to the item "Sound".



Open the "Sound" window.

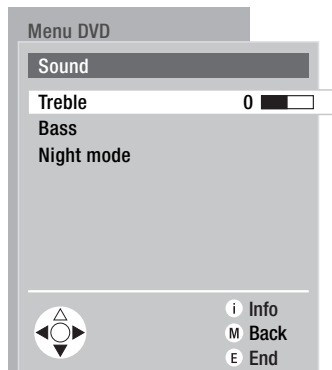

Go to the item "Treble" or "Bass".



Change the current setting as you wish; you can follow the procedure on the bar and the number in front of it.

Night mode

When you switch on the "Night mode" function, loud passages of a Digital Dolby sound source are reduced in volume when played to avoid disturbing neighbors or children.

Here, too, there are two possibilities – exactly the same as for treble and bass settings: in the Sound menu in the Auro display or in the DVD menu.



Press the button.



The DVD menu is displayed.
Go to the item "Sound".



Open the "Sound" window.



Go to the item "Night mode".

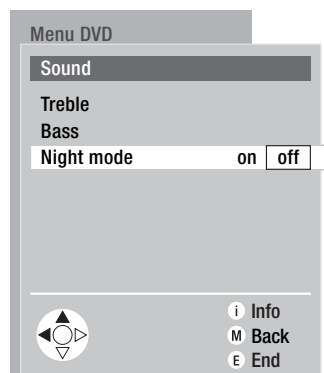

Select the "on" or "off" option.

This switches the night mode either on or off.

Audio functions

Sound mode

Unlike the other audio functions volume or treble and bass settings, the sound mode is a source-dependent audio function. Depending on which sound source is available with what audio features (Audio-CD, Tuner, DVD, TV, ...), you can choose between different formats for the sound output.

The standard setting of the sound mode is "Automatic". In this sound mode, Auro plays the sound source in original format. In the case of a digital multi-channel signal, the playback with the best quality is selected. However, you can select a different sound mode at any time.

Select the "Surround" sound mode when you want to hear an audio CD or a radio station over all speakers.

In Dolby ProLogic II the modes **PL II Movie** and **PL II Music** are distinguished. In "Movie" the center channel for Dolby is more strongly accentuated to highlight voice reproduction. In "Music" the setting is optimized to music reproduction.

by the Sound menu in the device display

If your remote control is set to one of the modes DVD/CD, REC, or FM-RADIO:



Press the button (repeatedly).



(SOUND) appears in the Auro display.

You can choose from the available sound modes by pressing ◀ ▶.

with the menu bar (not for tuner mode):



Press the button.



Menu bar is displayed.

Go to the element "Sound mode".



Go to the sound mode of your choice, to Surround, in our example:



Press the button **OK**. The selected sound mode is entered.



Press button to hide menu bar.

Symbols in the Auro display

The currently valid features of the sound mode are represented by symbols in the Auro display. See the following table for the meanings of these symbols:

Symbol	Sound mode
	Stereo analog (sound source)
	dts; multi-channel digital
	Dolby Digital; multi-channel format digital (sound source)
	Dolby ProLogic II; multi-channel analog (audio output "Movie" and "Music" respectively)

The above displays appear in clear text in the message line (see page 5) additionally for two seconds.

Setting the remote control

The different Loewe sets can be set as follows on the Assist remote control:

Device

Loewe TV (Chassis L2650 ≥ V4.4)

Loewe TV (Chassis L2600)

Loewe TV (Chassis Q25x0)

Loewe Centros 11x2

Loewe Centros 12x2/21x2

Loewe ViewVision DR+

Loewe ViewVision 8106 H

Loewe Auro 2216 PS/8116 DT

Loewe Xemix 6222 PS

* Factory setting

Button combination

TV + 7 (pqrs) *

TV + 7 (pqrs)

TV + 7 (pqrs)

REC + 1

REC + 2 (abc) *

REC + 3 (def)

REC + 0 (AV)

DVD + 4 (ghi) *

DVD + 5 (jkl)

The specified key combination must be pressed (approx. 5 s) until one of the LEDs flashes twice.

Remote control Assist – TV-operation

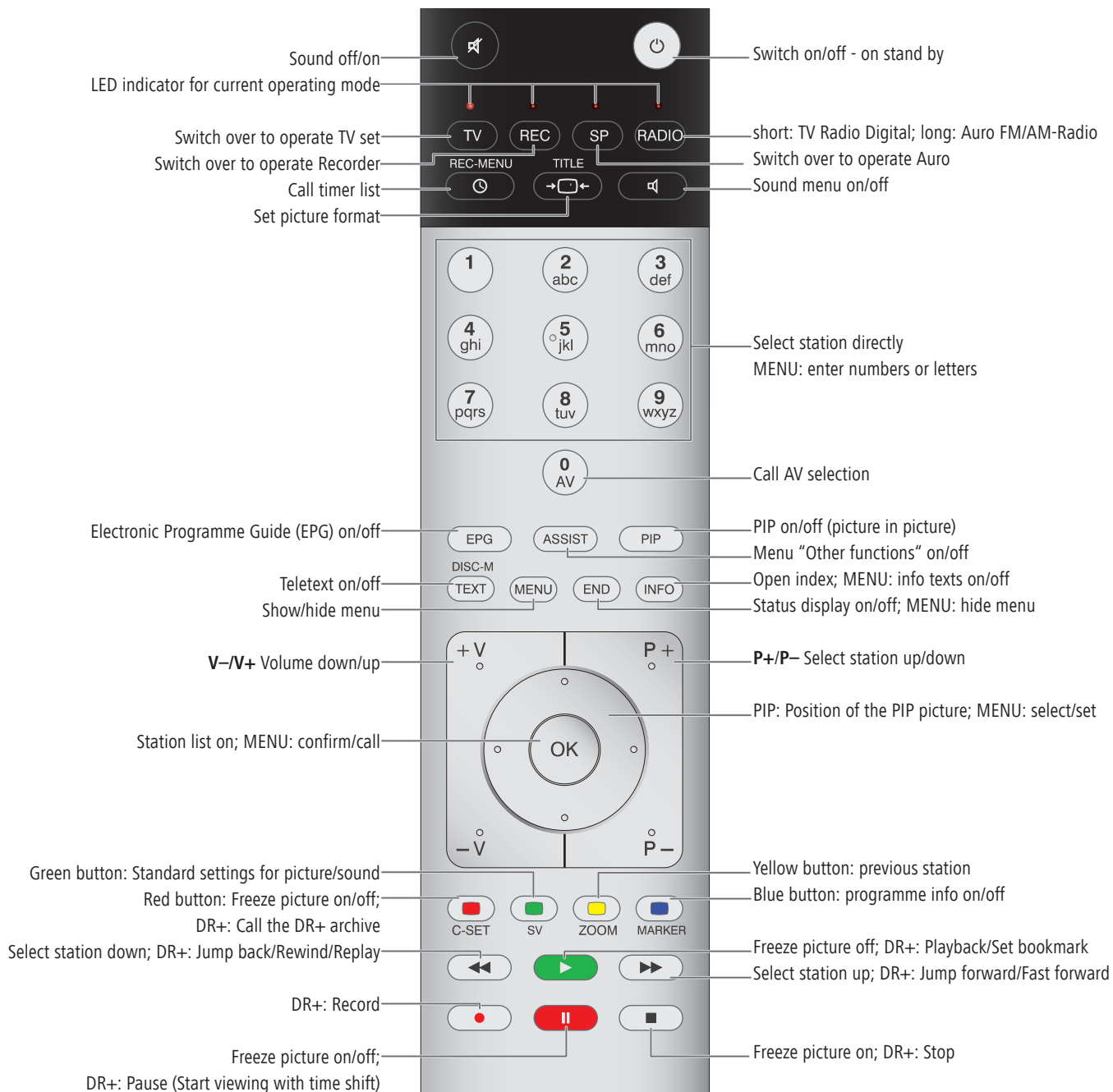

What to do, if ...

Problem	Remedy
No standby display.	Has the device been connected to the mains properly?
No TV picture.	Has the TV been connected properly (see pg. 8)?
The message "Wrong country code" appears after loading a DVD.	Europe is within the DVD regional code 2. DVDs which you buy in Europe are designed for this country code. You cannot play DVDs with other country codes.
Distorted picture.	Check the disc for finger marks; wipe clean with a soft cloth from the center to the edges if necessary.
Completely distorted display of the user interface or: no color in the TV picture with the user interface displayed or: distorted picture or black and white picture with DVD.	Auro is set to the wrong TV norm (NTSC or PAL); see pg. 12.
Disc cannot be played.	Is the DVD loaded with the labeled side up? Has the loaded disc got a playback format which Auro cannot handle (see "Technical Data" on pg. 43)?
No sound.	<ol style="list-style-type: none"> 1. Do you have to set up an additional audio connection (pg. 9)? 2. In Component Video mode: the software of the Loewe LCD TV must be > V2.x.
Auro does not react to remote control.	<ol style="list-style-type: none"> 1. Is Digital Link switched on on Auro? See "Activate Digital Link?" on pg. 12. 2. Point the remote control directly at the front of Auro. 3. Make sure the front of Auro is not obstructed. 4. Are the batteries in the remote control OK? 5. DVD/CD allows no further operations. Read the leaflet which comes with the DVD/CD.
The TV does not recognize Auro.	<ol style="list-style-type: none"> 1. Is the L-Link connection to the TV established (see pg. 9)? 2. Your TV set must be equipped with software 6.x (Q/S/P 25xx) or higher. Have a look in the "Main Information /Equipment" menu of your TV. Do you have an older version of the TV software? Contact your Loewe dealer for a TV software update if necessary.
DVD picture is green and is displayed twice on the screen.	Check Progressive Scan setting (see page 12).
Picture too dark, one of the colours missing or too weak and discoloration visible on the screen.	Check Progressive Scan wiring (see page 9).
TV shows no DVB station (L-Link connection present).	Disconnect the TV and Auro from the mains and switch back on.
With use of the component signal and at the same time "TV as centre loudspeaker" (see page 9): No sound on replay of an analog device (e.g. video recorder, analog set-top box) connected to the AV sockets (AV1/2, AVS) of the Loewe Flat TV or digital device without use of the digital sound through "audio digital assignment" (e.g. DVD player/recorder).	Connect the "AUDIO OUT L/R" sockets of the Loewe TV device to the SCART socket "TO TV" of Auro using an adapter cable stereo cinch -> SCART (available in specialised trade).

Technical Data

General

Auro 2216 PS	article number 65201A/D00
Mains	AC 110-240V, 50/60 Hz, Protection class 1
power consumption	Operating: 15 W Standby: 2 W
Dimensions	430 X 75 X 325 mm
Weight	3,6 kg
Operating temperature	5 °C - 35 °C
Humidity	5 % - 90 % (no condensation)

Playback

Playback formats	DVD-Video, DVD-Audio DVD-R, DVD-RW (Video Mode), DVD+R, DVD+RW, JPEG, Kodak Picture CD (JPEG), CD, CD-R, CD-RW, HDCD MP 3 (128kBit), WMA
------------------	---

Video

Standard	TV Standard PAL / NTSC Picture format 16:9, Letterbox 4:3, Pan & Scan 4:3 Digital image processing 12 bit Progressive scan
Frequency response	DVD (PCM 48 kHz): 8 Hz - 22 kHz, CD: 8 Hz - 20 kHz DVD (PCM 96 kHz): 8 Hz - 44 kHz

Audio

Audio-standards	Dolby Digital (AC-3), Dolby Prologic II, DTS, MPEG, PCM Digital audio signal processing 24 bit > 100 dB (AUDIO OUT connection) < 0,008% (AUDIO OUT connection) > 95 dB (AUDIO OUT connection)
-----------------	--

Tuner

Type	PLL, RDS
AM-Band	522 - 1611 kHz, width 9kHz
FM-Band	87,5 - 108,0 MHz
Preset memory	36 FM, 24 AM

Connections

FM	FM-antenna-Input, 75 Ohm
AM	AM-antenna-Input
TO TV	1.0 Vp-p, 75Ohm, RGB/FBAS, SCART (Y) 1,0 V (p-p), 75 Ohm, negative Sync., RCA socket x 1 (Pb)/(Pr) 0,7 V (p-p), 75 Ohm, RCA socket x 2
COMPONENT VIDEO OUT	0 dBm über 47 kOhm, RCA socket (L, R) x 2 RCA socket
AUX 1 IN (Analog Audio)	2,0 Vrms (1 kHz, 0 dB), 600 Ohm, RCA socket (L, R) x 1 / SCART
AUX 2 DIGITAL IN	0,5 V (p-p), 75 Ohm, RCA socket x 1
AUX1 OUT (Analog Audio)	PREOUT (controllable 5.1 output max.3 Vrms) PCM, MPEG, AC3, dts RCA socket 6x: L, C, R, SL, LFE, SR
AUX 2 DIGITAL OUT	9-pol JST
PREOUT	8-pol Mini-DIN
Cubic socket	8-pol Mini-DIN
L-Link TV	jack 3,5 mm
L-Link EXT	
Front headphones	

- Design and technical specifications are subject to change without notice.
- Manufactured under license from Dolby Laboratories. Dolby, ProLogic and the double-D symbol are trademarks of Dolby Laboratories.
- "DTS" and "DTS Digital Out" are trademarks of Digital Theater Systems, Inc.

Service

(A)

Loewe Austria GmbH
Parking 12
1010 Wien, Österreich
Tel +43 - 1 22 88 633 - 0
Fax +43 - 1 22 88 633 - 90
Email loewe@loewe.co.at

(AUS)

International Dynamics
Australasia Pty Ltd.
129 Palmer Street
Richmond 3121, Victoria,
Australia
Tel +61 - 3 - 94 29 08 22
Fax +61 - 3 - 94 29 08 33
Email mail@international
dynamics.com.au

(B NL L)

Loewe Opta Benelux NV/SA
Uilenbaan 84
2160 Antwerpen, België
Tel +32 - 3 - 2 70 99 30
Fax +32 - 3 - 2 71 01 08
Email ccc@loewe.be

(BG)

Darlington Service
Kn. Klementina Street, bl. 193
1618 Sofia, Bulgaria
Tel +359 - 2 955 63 99
Fax +359 - 2 955 63 99
Email sac@audio-bg.com

(CH)

Telion AG
Rütistrasse 26
8952 Schlieren, Schweiz
Tel +41 - 44 732 15 11
Fax +41 - 44 732 15 02
Email lgelpke@telion.ch

(CY)

HADJIKYRIAKOS & SONS LTD.
121 Prodomos Str., P.O Box
21587
1511 Nicosia, Cyprus
Tel +357 - 22 87 21 11
Fax +357 - 22 66 33 91
Email savvas@hadjikyriakos.
com.cy

(CZ)

K+B PROGRES A.S.
U Expertu 91
25069 Klicany u Prahy, Česko
Tel +420 2 72 12 21 11 (222)
Fax +420 2 72 12 22 39
Email loewe@kbexpert.cz

(D)

Loewe Opta GmbH,
Customer Care Center
Industriestraße 11
96317 Kronach, Deutschland
Tel +49 1801-22256393
Fax +49 9261-99500
Email ccc@loewe.de

(DK)

Kjaerulff 1 A/S
C.F. Tietgens Boulevard 19
5220 Odense SØ, Denmark
Tel +45 - 66 13 54 80
Fax +45 - 66 13 54 10
Email mail@kjaerulff1.com

(E)

Gaplasa S.A.
Conde de Torroja, 25
28022 Madrid, España
Tel +34 - 917 48 29 60
Fax +34 - 913 29 16 75
Email loewe@maygap.com

(EST)

TEDRA TRADING OY
Kuusemetsa 3
Saue 76506, Estonia
Tel +372 - 50 14 817
Fax +372 - 67 09 611
Email raivo@futurehifi.com

(F)

Loewe Opta France S.A.
13 rue du Dépôt,
Parc del l'Europe, BP 10010
67014 Strasbourg Cédex, France
Tel +33 - 3 - 88 79 72 50
Fax +33 - 3 - 88 79 72 59
Email loewe.france@wanadoo.fr

(FIN)

Kjaerulff 1 OY
Uudenmaantie 100
20760 Piispansilta, Finland
Tel +358 - 20 751 3800
Fax +358 - 20 751 3801
Email loewetuki@kjaerulff1.com

(GB)

Loewe UK Limited
Century Court, Riverside Way
Riverside Business Park, Irvine,
Ayrshire
KA11 5DD, UK
Tel +44 - 1294 315 000
Fax +44 - 1294 315 001
Email enquiries@loewe-uk.com

(GR)

ISSAGOGIKI EMBORIKI ELLADOS
S.A.
321 Mesogion Av.
152 31 Chalandri-Athens, Hellas
Tel +30 - 210 672 12 00
Fax +30 - 210 674 02 04
Email christina@bose-onkyo.gr

(H)

Basys Magyarorszag KFT
Tó park u.9.
2045 Törökbálint, Magyar
Tel +36 - 2341 56 37 (121)
Fax +36 - 23 41 51 82
Email basys@mail.basys.hu

(HR)

Plug&Play
Bednjanska 8, 10000 Zagreb
Hrvatska (Kroatia)
Tel +385 1 4929 683
Fax +385 1 4929 682
Email loewe@loewe.hr

(I)

Loewe Italiana SRL
Largo del Perlar, 12
37135 Verona (VR), Italia
Tel +39 - 045 82 51 611
Fax +39 - 045 82 51 622
Email Stefano.Borgognoni@
loewe.it

(IL)

PL Trading (pz 2004) Ltd.
27, Aliat Hanoar St.
Givataim 53401, Israel
Tel +972 - 3 - 57 27 155
Fax +972 - 3 - 57 27 150
Email zeev@loewe.co.il

(IRL)

Origo Ltd
Unit 23 Magna Drive
Magna Business Park, City West
Dublin 24, Republic of Ireland
Tel +353-1-4666700
Fax +353-1-4666706
Email service@origo.ie

(KSA)

SAS
Hamad Al Haqueel Street,
Rawdah, Jeddah
Kingdom of Saudi Arabia
Tel +966 (2) 665 4616 ext: 666
Fax +966 (2) 660 7864
Email hrant@sas-syseng.com

(LT)

A Cappella
Ausros Vartu 5, Pasazo skg.
01129 Vilnius, Lithuania
Tel +370 - 52 12 22 96
Fax +370 - 52 62 66 81
Email: aretas@acappella.lt

(M)

DONEO CO. LTD
34/36 Danny Cremona Street
Hamrun, HMR02, Malta
Tel +356 - 21 - 22 53 81
Fax +356 - 21 - 23 07 35
Email info@doneo.com.mt

(MA)

SOMARA S.A.
377, Rue Mustapha El Maani
20000 Casablanca, Morocco
Tel +212 - 22 22 03 08
Fax +212 - 22 26 00 06
Email somara@somara.ma

(N)

CableCom AS
Ostre Kullerød 5
3241 Sandefjord, Norge
Tel +47 - 33 48 33 48
Fax +47 - 33 44 60 44
Email odd@cablecom.no

(NZ)

International Dynamics (NZ) Pty
Ltd
PO Box 109 317, Newmarket
Auckland, New Zealand
Tel +64 9 379 0179
Fax +64 9 379 0279
Email: enquiries@international
dynamics.co.nz

(P)

Mayro Magnetics Portugal, Lda.
Rua Professor Henrique de Barros
Edifício Sagres, 2º. C
2685-338 Prior Velho, Portugal
Tel +351 - 21 942 78 30
Fax +351 - 21 942 78 30
Email geral.loewe@mayro.pt

(PL)

DSV TRADING SA
Plac Kaszubski 8
81-350 Gdynia, Polska
Tel +48 - 58 - 6 61 28 00
Fax +48 - 58 - 6 61 44 70
Email market@dsv.com.pl

(RO)

Avitech Co. SRL
1/II Pipera Tunari St.
007190 Voluntari, Ilfov, Romania
Tel +40 - 21 200 64 64
Fax +40 - 21 200 64 65
Email andrei.silisteanu@avitech.ro

(RUS)

Service Center Loewe
ul. Verkhnaya Maslovka, d. 29
125083 Moscow, Россия
Tel +7 - 495 612 50 43
Fax +7 - 495 612 47 10
Email service@atc.ru

(S)

Kjaerulff 1 AB
Ridbanegatan 4, Box 9076
200 39 Malmö, Sverige
Tel +46 - 4 06 79 74 00
Fax +46 - 4 06 79 74 01
Email Sweden@kjaerulff1.com

(SK)

BaSys Czech & Slovak s.r.o.
Ostre Kullerød 17/A
831 04 Bratislava, Slovakia
Tel +421 2 49 10 66 18
Fax +421 2 49 10 66 33
Email: loewe@basys.sk

(TR)

ENKAY ELEKTRONIK SAN. Ve Tic.
Ltd. Sti.
Alemdag Cad: Site Yolu No.: 10
81230 Ümraniye/ Istanbul, Türkiye
Tel +90 - 216 634 44 44
Fax +90 - 216 634 39 88
Email mhatipog@enkaygroup.com

(UAE)

Dubai Audio Center
P.O. Box 32836, Sheik Zayed Road
Dubai, UAE
Tel +971 - 4 343 14 41
Fax +971 - 4 343 77 48
Email dacdubai@emirates.net.ae

(ZA)

THE SOUNDLAB (PTY) LTD
P.O. Box 31952, Kyalami 1684
Republic of South Africa
Tel +27 - 1 14 66 47 00
Fax +27 - 1 14 66 42 85
Email loewe@mad.co.za