

BOSE[®]

COMPANION[®] 3 Series II

MULTIMEDIA SPEAKERS

Owner's Guide

Guía de usuario



Notice d'utilisation



SAFETY INFORMATION

Please read this owner's guide

Please take the time to follow this owner's guide carefully. It will help you set up and operate your system properly and enjoy its advanced features. Please save your owner's guide for future reference.

-  **WARNING:** To reduce the risk of fire or electric shock, do not expose this system to rain or moisture.
-  **WARNING:** The apparatus shall not be exposed to dripping or splashing, and objects filled with liquids, such as vases, shall not be placed on the apparatus. As with any electronic products, use care not to spill liquids into any part of the system. Liquids can cause a failure and/or fire hazard.

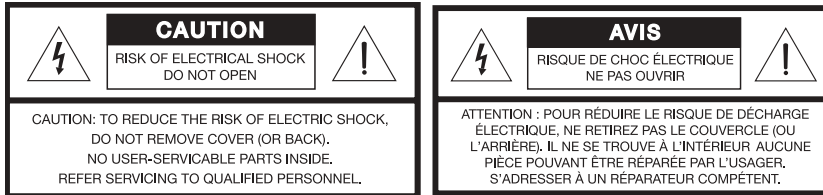

These CAUTION marks are located on the rear panel of the Acoustimass® module:







The lightning flash with arrowhead symbol within an equilateral triangle is intended to alert the user to the presence of uninsulated, dangerous voltage within the system enclosure that may be of sufficient magnitude to constitute a risk of electric shock.



The exclamation point within an equilateral triangle, as marked on the system, is intended to alert the user to the presence of important operating and maintenance instruction in this owner's guide.

Class B emissions

This Class B digital apparatus meets all requirements of the Canadian Interference-Causing Equipment Regulations (Canada only).

-  **WARNING:** To prevent electric shock, match the wide blade of the line cord plug to the wide slot of the AC (mains) receptacle. Insert fully.
-  **WARNING:** Do not place computer monitors, floppy disks, hard drives, or other magnetic media within 6 inches of the Acoustimass module. The magnetic field produced by this module can erase magnetic media and interfere with the monitor.
-  **WARNING:** No naked flame sources, such as lighted candles, should be placed on the apparatus.
-  **CAUTION:** Long-term exposure to loud music may cause hearing damage. It is best to avoid extreme volume when using headphones, especially for extended periods.



This product conforms to the EMC Directive 89/336/EEC and to the Low Voltage Directive 73/23/EEC. The complete Declaration of Conformity can be found at www.bose.com/static/compliance/index.html.

Notes:

- The product label is located on the bottom of the product.
- Where the mains plug or appliance coupler is used as the disconnect device, such disconnect device shall remain readily operable.
- The product must be used indoors. It is neither designed nor tested for use outdoors, in recreation vehicles, or on boats.

Important Safety Instructions

1. **Read these instructions** – for all components before using this product.
2. **Keep these instructions** – for future reference.
3. **Heed all warnings** – on the product and in the owner's guide.
4. **Follow all instructions.**
5. **Do not use this apparatus near water or moisture** – Do not use this product near a bathtub, washbowl, kitchen sink, laundry tub, in a wet basement, near a swimming pool, or anywhere else that water or moisture are present.
6. **Clean only with a dry cloth** – and as directed by Bose Corporation. Unplug this product from the wall outlet before cleaning.
7. **Do not block any ventilation openings. Install in accordance with the manufacturer's instructions** – To ensure reliable operation of the product and to protect it from overheating, put the product in a position and location that will not interfere with its proper ventilation. For example, do not place the product on a bed, sofa, or similar surface that may block the ventilation openings. Do not put it in a built-in system, such as a bookcase or a cabinet that may keep air from flowing through its ventilation openings.
8. **Do not install near any heat sources, such as radiators, heat registers, stoves, or other apparatus (including amplifiers) that produce heat.**
9. **Do not defeat the safety purpose of the polarized or grounding-type plug. A polarized plug has two blades with one wider than the other. A grounding-type plug has two blades and a third grounding prong. The wider blade or third prong are provided for your safety. If the provided plug does not fit in your outlet, consult an electrician for replacement of the obsolete outlet.**
10. **Protect the power cord from being walked on or pinched, particularly at plugs, convenience receptacles, and the point where they exit from the apparatus.**
11. **Only use attachments/accessories specified by the manufacturer.**
12. **Use only with the cart, stand, tripod, bracket, or table specified by the manufacturer or sold with the apparatus. When a cart is used, use caution when moving the cart/apparatus combination to avoid injury from tip-over.** 
13. **Unplug this apparatus during lightning storms or when unused for long periods of time** – to prevent damage to this product.
14. **Refer all servicing to qualified service personnel. Servicing is required when the apparatus has been damaged in any way: such as power-supply cord or plug is damaged; liquid has been spilled or objects have fallen into the apparatus; the apparatus has been exposed to rain or moisture, does not operate normally, or has been dropped** – Do not attempt to service this product yourself. Opening or removing covers may expose you to dangerous voltages or other hazards. Please call Bose to be referred to an authorized service center near you.
15. **To prevent risk of fire or electric shock, avoid overloading wall outlets, extension cords, or integral convenience receptacles.**
16. **Do not let objects or liquids enter the product** – as they may touch dangerous voltage points or short-out parts that could result in a fire or electric shock.
17. **See product enclosure bottom for safety-related markings.**
18. **Use proper power sources** – Plug the product into a proper power source, as described in the operating instructions or as marked on the product.

Information about products that generate electrical noise

If applicable, this equipment has been tested and found to comply with the limits for a Class B digital device, pursuant to Part 15 of the FCC rules. These limits are designed to provide reasonable protection against harmful interference in a residential installation. This equipment generates, uses, and can radiate radio frequency energy and, if not installed and used in accordance with the instructions, may cause harmful interference to radio communications. However, this is no guarantee that interference will not occur in a particular installation. If this equipment does cause harmful interference to radio or television reception, which can be determined by turning the equipment off and on, you are encouraged to try to correct the interference by one or more of the following measures:

- Reorient or relocate the receiving antenna.
- Increase the separation between the equipment and receiver.
- Connect the equipment to an outlet on a different circuit than the one to which the receiver is connected.
- Consult the dealer or an experienced radio/TV technician for help.

Note: *Unauthorized modification of the receiver or radio remote control could void the user's authority to operate this equipment.*

This product complies with the Canadian ICES-003 Class B specifications.



GETTING STARTED	6
Congratulations on your choice	6
Unpacking the carton	6
SETUP AND CONNECTIONS	7
Placing your system	7
Positioning the Acoustimass® module	7
Positioning the speakers	8
Making connections	8
Connecting the speakers to the module	9
Connecting the power cord	10
Connecting other sources	10
USING YOUR SPEAKER SYSTEM	11
Controlling the system	11
Balancing tone for the sound you like	12
Troubleshooting.	12
REFERENCE	13
Cleaning the system	13
Contacting Customer Service	13
Limited warranty	13
Technical Information	13

For your records

The system serial number is located on the bottom of the Acoustimass module.

Serial number: _____

Dealer name: _____

Dealer phone: _____

We suggest you keep your sales receipt together with this owner's guide.

Now would be a good time to register your product online at www.bose.com/register.

GETTING STARTED

Congratulations on your choice

Thank you for purchasing the Bose® Companion® 3 Series II multimedia speaker system. Bose designed this amplified system to provide true-to-life stereo performance for music, computer games, and video, plus high-quality sound from a variety of desktop audio sources. Unique features make this system a superior choice for home or office workspaces.

Companion 3 multimedia speaker system benefits include:

- Small speakers and an easy-to-hide Acoustimass® module that keep your workspace clutter free.
- TrueSpace® stereo signal processing for a wide soundstage from speakers positioned close together.
- Control pod for at-hand volume adjustments and mute capability plus jacks to connect headphones or external equipment like a CD player, MP3 player, or other audio source.
- Magnetic shielding that allows speaker placement next to your monitor or television without on-screen color distortion.

Unpacking the carton

Carefully unpack your speakers and save all of the packing materials, which provide the safest means for shipping or transporting. Check to be sure your system includes all of the parts (Figure 1).

If any part of the system appears damaged, do not attempt to use it. Notify your authorized Bose dealer immediately. Or, to contact Bose directly, refer to the address sheet included in the carton.

Figure 1

Carton contents

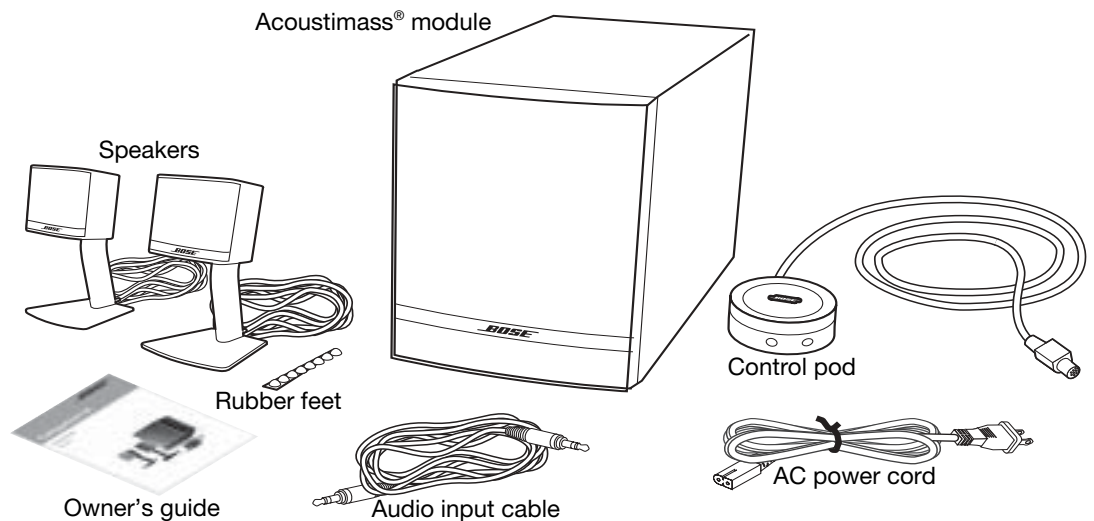

▲ WARNING: To avoid danger of suffocation, keep plastic bags out of the reach of children.

Now is a good time to copy the serial number, located on the back of the Acoustimass module, into the form labeled "For your records" on page 5.

Placing your system

The following guidelines are offered as an aid in placing the speakers and the Acoustimass® module to provide outstanding performance (Figure 2). Feel free to set up the system where it is most convenient and provides the sound you enjoy.

Figure 2

Recommended system placement

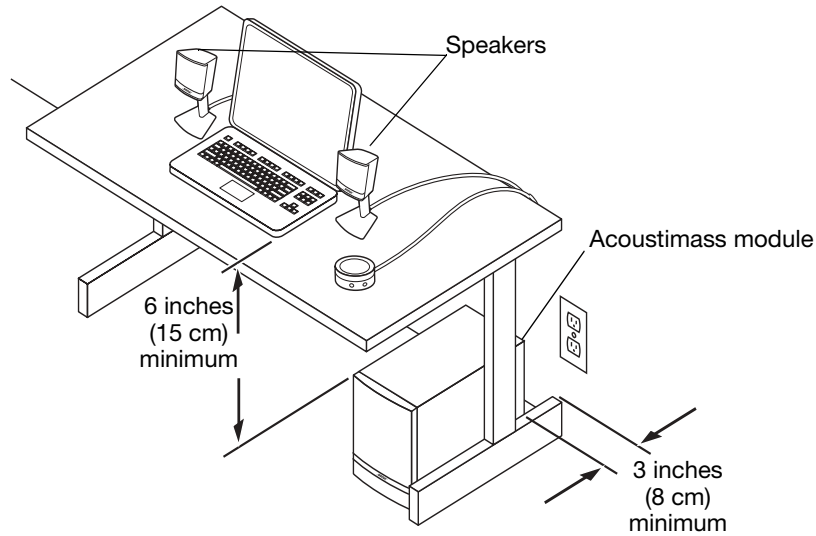

Positioning the Acoustimass® module

The Acoustimass module functions as the unseen part of the system. When placed under or behind furniture, for example, it plays an invisible role in producing lifelike sound.

Keep the module:

- Positioned on a flat surface.
- Within reach of an AC (mains) power outlet.
- With the rear of the module at least 3 inches (8 cm) from a wall.
- With the front aimed away from the wall to decrease or toward the wall to increase bass.
- At least 6 inches (15 cm) from your computer monitor or TV to avoid interference from the module, which is not magnetically shielded.
- Where nothing blocks the openings on the back of the module, which provide ventilation to prevent overheating during use.
- Away from heat sources (radiators, baseboards, quartz heater, etc.).
- Resting on the bottom surface, not on the top, a side, or either end (Figure 3).

Figure 3

Module placement

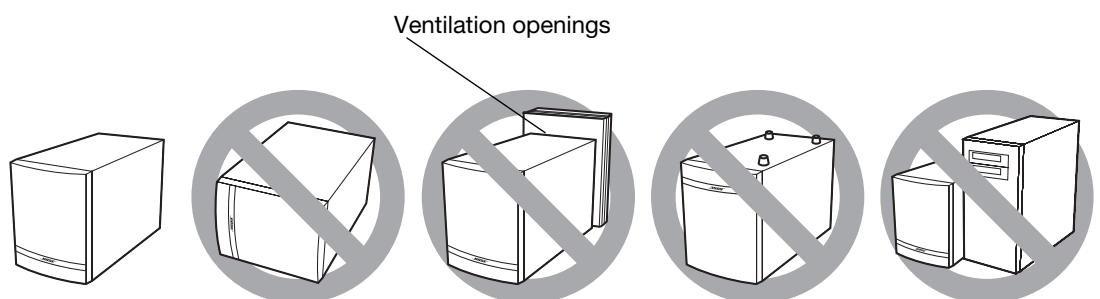

SETUP AND CONNECTIONS

Other suggestions:

- Use the supplied audio input cable, which allows for placement of the module up to 6 feet (2 m) from your sound source.
- To place the module farther from the source, use a shielded audio input extension cable available from retail electronics stores.

Positioning the speakers

The supplied speaker cables allow the speakers to be set up within 6 feet (2 m) of the module.

The speakers are designed for desktop placement on stands that lift them slightly above the surface or for resting directly on it.

If you prefer to use the speakers without stands, removing them is simple (Figure 4). After removing a speaker from the stand, apply the supplied rubber feet to the bottom surface for stability.

⚠ CAUTION: Choose a stable, level surface for the speakers and stands. Vibration can cause them to move, particularly on smooth surfaces like a desktop.

Keep the speakers:

- Up to 3 feet (91 cm) from the sides of the screen.
- At equal distance on each side of the computer monitor or TV and slightly angled away from it (Figure 2 on page 7).

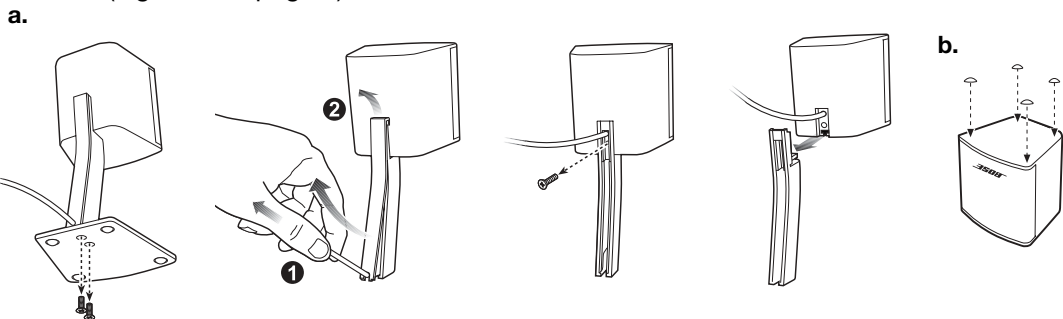

Figure 4

Removing a speaker from the stand (a) and applying rubber feet (b) to the speaker

Making connections

Custom cables supplied with this system simplify connections to the labeled jacks on the rear of the Acoustimass® module (Figure 7).

⚠ CAUTION: Do not plug the Acoustimass module into an AC power (mains) outlet until all the source components are connected to the module.

Connecting the speakers to the module

The speakers, control pod, and computer all connect directly to the Acoustimass® module.

1. Insert the connector on each speaker cable into the corresponding L or R jack labeled To Speakers on the rear of the Acoustimass module (Figure 5).

Figure 5

Speaker connection jacks

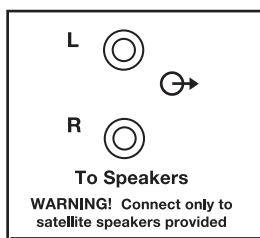

CAUTION: Connect only Companion® 3 speakers to these jacks. Connecting any other electronic device to these jacks may damage your speaker system.

2. Insert the control pod cable into the jack labeled To Control Pod on the rear of the module. Be sure the cable connector is right side up, with the arrow showing (Figure 6).

Figure 6

Proper control pod cable connection

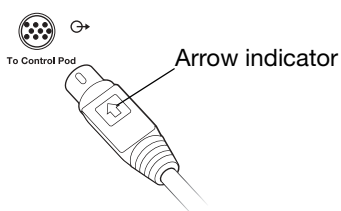

3. Insert the connector on one end of the supplied audio input cable into the jack labeled From Computer on the rear of the module. Connect the other end to the audio output jack on your computer (Figure 7).

Figure 7

Labels on the module for ease in making connections

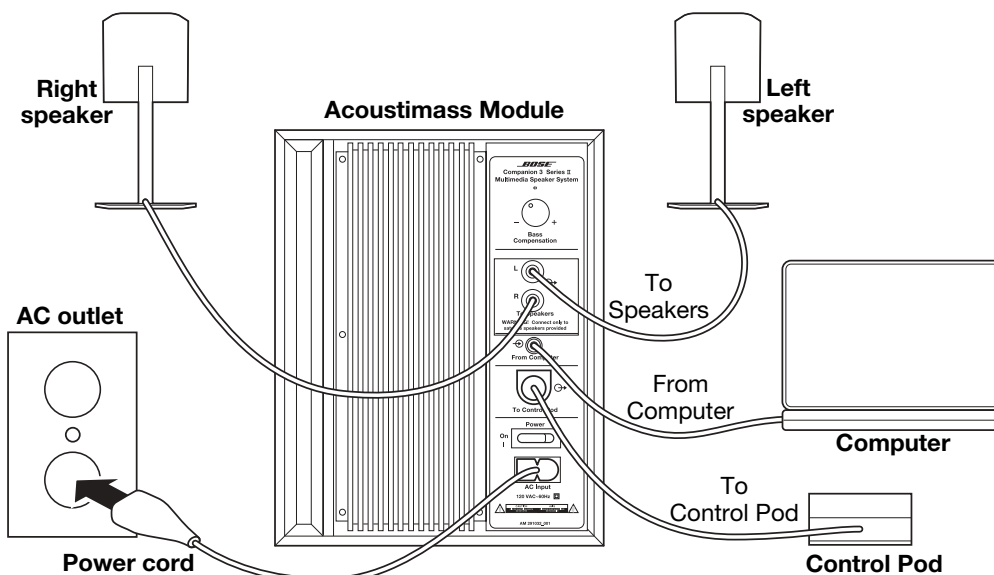

Note: If your sound source has phono jacks instead of a stereo mini jack, use an audio adapter cable available from retail electronics stores. Connect the adapter to the audio input cable and insert the adapter into the phono jacks on your source.

Connecting the power cord

Plugging in and turning on the Acoustimass® module is the final step before using the system.

1. Insert the small connector end of the power cord into the AC INPUT jack on the module.
2. Plug the large connector into an AC power (mains) outlet.
3. Turn the power switch, located on the back of the Acoustimass module, to ON (I).

On the control pod, the LED turns yellow to indicate the system is on and is ready for use.

Connecting other sources

The control pod features two jacks: one for connection directly to another sound source and the other for a headphone.

- To connect an external CD or MP3 player to your system, plug the cable from the sound source output jack into the input jack (Ⓜ) on the control pod. See Figure 8 on page 11.
- To connect headphones, insert the connector on the headphone cable into the headphone jack (🎧) on the control pod. This connection mutes the sound from the speakers.

Controlling the system

To begin using your Companion® 3 speaker system (Figure 8):

1. Be sure your computer or other sound source is turned on.
2. If you have not yet done so, also turn on the power switch on the rear of the Acousti-mass® module.

If the LED on the control pod is yellow, touch the top of the control pod to activate the system. The light then turns green.

Figure 8

Switches and settings

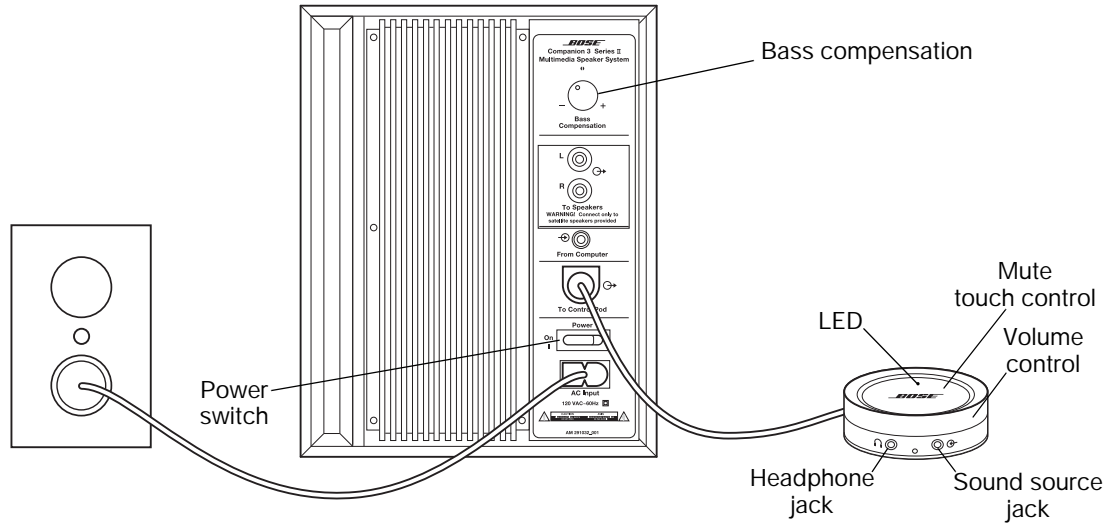

Controlling the volume

To adjust the sound level using your speaker system controls:

- For volume – Rotate the outer band on the control pod clockwise to increase or counter-clockwise to decrease the volume (Figure 8).
- For mute – Gently press the mute touch control on the pod. To unmute, press again.

The control pod LED light turns yellow when the system is muted, and green when it is active.

To use the sound source volume control instead of the control pod:

- Rotate the outer band on the control pod clockwise until it approaches maximum volume.
- Use the volume control on your computer or other sound source to adjust the level as you listen.

Note: Setting a source volume control to the highest level may activate the speaker system's internal protection circuitry and reduce speaker volume.

Balancing tone for the sound you like

The acoustics of your room affects the sound you hear there. Upholstered furniture, carpets, and drapes absorb sound, which can muffle the treble (high frequencies). Bare floors, walls, and furniture have the opposite effect and can make the treble sound shrill.

A bass compensation control on the Acoustimass® module enables you to balance the tones you hear.

There are two ways to adjust the bass:

- Turn the control clockwise to increase or counterclockwise to decrease bass.
- Reposition the module. To increase bass, turn the front of the module toward a wall or other nearby surface. To decrease bass, aim the front from the wall.

Troubleshooting

<i>Problem</i>	<i>What to do</i>
The speaker system does not play	<ul style="list-style-type: none"> • Make sure all connections are secure. (See “Making connections” on page 8.) • Check your speaker wires for damage or frays, which can cause an open or short circuit. • Be sure that the sound source is plugged in and playing at an audible volume. • Make sure the power is on and the system is not muted. The LED on the control pod should be green when unmuted. • If using a PC, check your sound card settings to make sure the “Digital output only” setting is turned OFF. This setting is typically found in the Options menu of the volume control icon. This icon is usually located in the lower right-hand corner of the Windows desktop.
The speaker system sound seems distorted	<ul style="list-style-type: none"> • Decrease the volume of the sound source and increase the speaker system volume using the control pod.
One speaker does not perform or sounds distorted	<ul style="list-style-type: none"> • Check connections from the speakers, control pod, and computer to the Acoustimass® module. (See “Making connections” on page 8.) • Be sure the cable from the unheard speaker is firmly inserted in the proper To Speaker jack on the module. • Switch the connection of both speakers to jacks on the rear of the Acoustimass module. <ul style="list-style-type: none"> - If this does not resolve the problem for the originally unheard speaker, this speaker may be the cause. Contact Bose® Customer Service. - If the problem switches to the other speaker (the one that previously performed) a defective output channel on the sound source may be the cause. Try a different source. - If this does not resolve the problem, the Acoustimass module may be the cause. Contact Bose Customer Service. • Check balance levels on your sound source.

Cleaning the system

Wipe the speakers and module with a dry cloth.

- Do not use solvents or chemicals.
- Do not allow liquids or objects to enter the rear panel or the front port of the module; the speaker grilles, or any part of the control pod.

Contacting Customer Service

For additional help in solving problems, contact Bose® Customer Service. Refer to the address sheet included in the carton.

Limited warranty

This system is covered by a transferable limited warranty.

Details of the limited warranty are provided on the Product Registration Card that came with your system. Please fill out the information section on the card and mail it to Bose. Failure to do so, however, will not affect your limited warranty rights.

Technical Information

Driver complement

Two magnetically shielded 2-inch (5.0 cm) long-throw, wide-range transducers
One 5.25-inch (13.3 cm) woofer

Power rating

USA/Canada: 120V \sim 50/60 Hz
International: 220-240V \sim 50/60 Hz
Japan: 100V \sim 50/60 Hz

Dimensions (approximate)

Speakers on stand: 6"H x 3 $\frac{3}{8}$ "W x 3 $\frac{1}{4}$ "D (15 cm x 8.6 cm x 8.2 cm)
Speakers without stand: 2 $\frac{1}{2}$ "H x 2 $\frac{3}{4}$ "W x 2 $\frac{1}{2}$ "D (6.3 cm x 7.1 cm x 6.3 cm)
Acoustimass® module: 8 $\frac{1}{2}$ "H x 6 $\frac{3}{4}$ "W x 13 $\frac{3}{4}$ "D (21.7 cm x 17.2 cm x 34.8 cm)
Control pod: 2 $\frac{1}{2}$ "Dia x 1 $\frac{1}{8}$ "H (6.3 cm x 2.8 cm)

Weight (approximate)

One speaker, unpacked: 0.8 lb (0.4 kg)
Acoustimass module, unpacked: 14.7 lb (6.7 kg)
Control pod: 0.5 lb (0.2 kg)



296583

BOSE[®]
Better sound through research[®]

©2006 Bose Corporation, The Mountain,
Framingham, MA 01701-9168 USA
AM296583 Rev.01