

SENCOR®

Let's live!



LED TV

SLE 2464TCS

SLE 3258TCS

INSTRUCTION MANUAL

EN



PLEASE, READ THESE INSTRUCTIONS BEFORE STARTING TO OPERATE THE TELEVISION. STORE IT FOR LATER REFERENCE. NOTE DOWN THE MODEL NUMBER AND THE SERIAL NUMBER OF THE TV SET. LOOK AT THE LABEL ON THE BACK COVER AND PASS THE INFORMATION PROVIDED THERE TO YOUR DEALER IN CASE THAT YOU WOULD NEED SERVICING.

Contents

1.	Important safety conditions.....	2
2.	Functions and Features.....	9
3.	Device.....	10
	3.1. Joystick control (only SLE 3258TCS).....	10
	3.2. Button controls (only SLE 2464TCS).....	11
4.	Remote controller.....	14
	4.1. Electronic program guide (EPG).....	17
5.	Installation.....	19
6.	Video Recording (PVR).....	21
	6.1. Quick recording and playing with a press of a button.....	21
	6.2. Recording Timer.....	22
7.	Menu Setup.....	24
	7.1. Picture.....	24
	7.2. Sound.....	24
	7.3. Channel.....	25
	7.4. Options.....	26
	7.5. Lock.....	27
8.	USB CONTROL.....	29
	8.1. USB menu.....	30
	8.2. Movie playback.....	31
	8.3. Music playback.....	31
	8.4. Viewing photos.....	32
9.	Troubleshooting.....	34
10.	Technical specifications.....	36
	10.1. Information sheet.....	38

1. Important safety conditions

To be able to use this product properly, read this user's manual carefully and keep it for future reference. If you plan to give (sell) this device to a third person, include all documentation, including this manual, with the transaction.

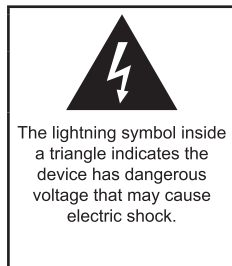

CAUTION

RISK OF ELECTRIC SHOCK – DO NOT OPEN!

TO REDUCE THE RISK OF ELECTRIC SHOCK, DO NOT REMOVE THE COVER (OR BACK SIDE). THE INSIDE OF THE DEVICE DOES NOT CONTAIN PARTS THAT CAN BE REPAIRED BY THE USER. REFER TO AUTHORIZED REPAIR SHOPS FOR REPAIR WORK.

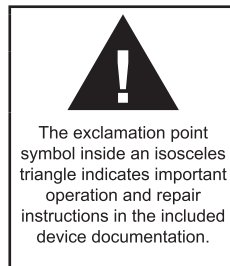

General safety instructions

- Please read this manual carefully before using the device. Follow this manual and the instructions inside.
- Heed all warnings.
- Follow all instructions.
- Use only the attachments and accessories specified by the manufacturer.
- **OPEN FLAMES, FOR EXAMPLE A BURNING CANDLE, SHALL NOT BE PLACED ON THE DEVICE. DO NOT PLACE HOT OBJECTS OR OBJECTS WITH AN OPEN FIRE ON THE DEVICE, FOR EXAMPLE CANDLES OR NIGHT LAMPS. HIGH TEMPERATURES MAY MELT PLASTIC COMPONENTS AND CAUSE FIRE.**
- Use the device in temperate climate.
- The manufacturer and vendor of the device are in not in any way liable for any direct or indirect damages caused by not following the instructions for installation, setup, operation, maintenance and cleaning of the device mentioned in this manual.
- Protect the device against impacts, falls, blows, shocks, vibration, moisture and dust.
- Prior to granting children consent to use the device, they shall become familiar with the proper and safe use of the player, corresponding to their age.
- If the device has a headphone jack, do not use headphones set to maximum volume. Risk of hearing damage or loss.

Installation, control

- Install the device according to the instructions in the manual.
- Leave free space around the device, it is necessary for proper air circulation. It helps to dissipate the heat generated by the operation of the device. By covering the air vents of the cabinet, you risk overheating and damage of the device. It is important to ensure that ventilation of the device is not prevented by covering the ventilation openings with e. g. newspaper, tablecloth, drapes, etc. Follow the installation instructions in the manual.

- This device shall not be kept in a closed area, such as a library or shelf, provided sufficient ventilation cannot be provided or the manufacturer's instructions cannot be followed.
- Do not place any objects into the air vents or any other holes. Risk of touching components with dangerous voltage or shorting parts that could cause fire or electric shock. Do not pour any liquids into the device.
- Do not install the device in direct sunlight, or close to heat sources, like radiators, heat exchangers, stoves or other appliances (including amplifiers) producing heat. High temperatures shorten the life of the electronic components of the device significantly. Do not use and do not leave the device near an open fire.
- The device must not be exposed to dripping or running water and you must not place upon it objects filled with liquid, e.g. vases. Protect the device against becoming wet, sprayed on or poured on by any liquid, do not leave or install the device outdoors. Do not use the device outdoors. You risk electric shock or fire by not adhering to these instructions.
- Do not use the device close to water.
- Handle the glass panels and cover of the device with care. The glass screen can break on impact and cause serious injury.
- Make sure the power cord is not stepped on or compressed, especially near the plug and point leading from the device or adapter. The power plug (adapter) is used to disconnect the system and must be easy to access.
- Do not use a device with a damaged power cord or plug. If the power cord or plug is damaged, turn off the device, disconnect it from the power supply and contact your authorized repair shop. Only a professional can replace a damaged power cord or plug. Under no circumstances should you attempt to replace the power cord or plug yourself.
- Do not attempt to bypass the safety function of the polarized plug. If the plug cannot be plugged into your socket, refer to an electrician to replace your obsolete socket.
- Before plugging the device into the socket make sure the voltage in your socket corresponds with the voltage on the label of the device or power adapter. If you are not sure of the type of power source you have in your home, refer to your vendor or local power company.
- Before switching the device on, check whether all power connections are in order and comply with the instructions of the manufacturer. Switch the device off and unplug it from the socket before plugging in or changing the connection of the device.
- Remember to always unplug the plug (adapter) from the socket before unplugging the power cord.
- Plug the power cord into an independent socket. Do not overload wall sockets using extension cords or unified sockets. Risk of electric shock.
- Hold the power cord by the plug and not by the cable when pulling out from the socket.
- Unplug the device from the socket during a thunderstorm, or when the device is not used for a longer period of time.

- Avoid carrying the device from a cool environment into a warm environment or vice versa, or operating the device in a moist environment. Air moisture may condense in some areas within the device case and may cause the device to become temporarily inoperable. In this case, leave the device in a warm and well-ventilated area and leave for 1–2 hours until the moisture evaporates. The device can be normally used again. Be especially cautious when using the device for the first time during a cool season immediately after purchasing.
- Do not place the device on an unstable cart, stand, console or table. The device can fall and cause serious injury to children or adults or seriously damage the device and other objects. Only carts, stands or tables defined by the manufacturer or sold with the device shall be used. Any mounting of the product should be carried out according to manufacturer's instructions and should use a mounting accessory recommended by the manufacturer.
- Do not lean against the device, do not lean over or use the device as a step. Avoid quick movements. Make sure children do not play with the machine.
- Be careful when moving the device when placed on a cart. Suddenly stopping, using excessive force and uneven surfaces may cause the cart holding the device to tip over.
- Under no circumstances are the manufacturer or vendor liable for any direct or indirect damage caused by the failure to observe the instructions for installation, configuration, operation, treatment and cleaning of this device included within this manual.
- Protect the device against impacts, falls, blows, shocks, vibration, moisture and dust.
- Do not expose the device to extreme temperatures or humidity.

**Note:**

If the device is powered by an adapter, only use the AC adapter and power cord included with the device. Do not use defective sockets. Make sure the cord is properly plugged into the socket. If the cord is loose, an electric arc can cause fire. Refer to a qualified electrician to replace sockets.

Note:

Plug the device into a properly grounded sockets with protective grounding pin only.

Note:

If you plan to mount the device to a wall or ceiling, follow the instructions of the manufacturer and the user's manual for the given system.

Repairs and maintenance

- To avoid risks of electric shock or fire, do not remove the device from the case – the case does not contain components that the user could repair or adjust without the necessary equipment and qualification. Refer to a professional service centre if your device requires service.
- In the event of any unusual occurrences during the use of the device, e.g. smelling the characteristic smell of burning insulation or even seeing a smoke, turn the device off immediately, disconnect the power supply and wait with continuing use of the device until you learn the result of its inspection by the service personnel.
- Leave all service to qualified service personnel. Service is necessary when the device is damaged in any way, for example in case of damage to the power cord, spilling liquid on the device, intrusion of foreign objects into the device, when the device is exposed to rain or moisture, if the device does not function in the usual manner or if it fell.
- When repairing or replacing a component of the device, make sure the repair technician used spare parts defined by the manufacturer to ensure the replaced components have the same features as the original. Unauthorized replacements can cause fire, electric shock or other risks.
- Prior to cleaning, moving or other maintenance work, unplug the cord (adapter) from the socket.
- Clean the device with a dry cloth only.
- Do not use gasoline, thinner or other solvents or abrasives, scouring pads, or sponges with scouring pads to clean the device.

Note:

Do not throw the device into your common household waste. Respect laws and regulations when disposing of the machine.

Remote controller and battery

- Do not expose the remote controller or battery to direct sunlight, or close to heat sources, like radiators, heat exchangers, stoves or other appliances (including amplifiers) producing heat. Do not use and do not leave the device near an open fire.
- Make sure the sensor is not exposed to intense light (e.g. sunlight) or fluorescent tube light, which could lower the efficiency and reliability of the remote controller.
- The remote controller or battery must not be exposed to dripping or running water and objects filled with liquid, e.g. vases, shall not be placed on the device. Protect the remote controller against becoming wet, sprayed or poured on by any liquid. Do not use outdoors. Failure to respect these instructions can lead to the remote controller or battery becoming damaged.
- Do not use the device close to water.
- The impact the battery disposal has on the environment shall be monitored carefully.
- Using the batteries incorrectly can result in leakage and corrosion. Follow the following instructions to ensure proper remote control operation:
 - Do not insert the batteries in the wrong direction.

- Do not charge, heat, open or short the batteries.
- Do not throw batteries into a fire.
- Do not leave dead batteries in the remote controller.
- Do not combine various types of batteries or old and new batteries.
- If you do not use the remote controller for a longer period of time, remove the batteries to prevent damaging the remote controller by the batteries leaking out.
- If the remote controller does not work correctly or its range decreases, replace all batteries with new ones.
- If there is an electrolyte leakage from the batteries, have the remote control serviced by an authorized technician.

**NOTICE:**

To prevent risk of fire or electric shock, do not expose the device to rain or moisture.

**NOTICE:**

The batteries must not be exposed to excessive heat, for example sunlight, fire, etc.

Note:

This device can be used in tropic and/or mild climate conditions.

Annex to the LCD screen user's manual

SENCOR®

Warning message when displaying static shots, red/blue/green/red pixels on the screen.

Displaying a static image can permanently damage the LCD panel.

- Do not display a static image on the LCD panel for a period longer than 2 hours. Risk of the image staying on the screen. This is referred to as the image being "burned into the screen." To prevent this from occurring, reduce the brightness and contrast level of the screen when viewing static images.
- A similar "burning" effect can take place with the LCD panel due to a TV channel logo being displayed for a long period of time.
- Using 4:3, 16:9 or similar aspect ratios, that do not cover the entire screen, can leave traces of the image displayed on the left, right or in the middle of the screen, caused by the different light intensity on the screen. Playing a DVD or a game console image can have a similar effect.
- Displaying the static image of video games and computers for a longer period of time can leave traces of the image on the TV screen. To avoid this effect, reduce your brightness and contrast when viewing static images.



The warranty does not apply to damage caused by the reasons stated above!

Red, blue, green and black pixels may appear on the screen.

- This is typical for liquid crystals and is not a defect. Liquid crystal displays are produced via very precise technology with fine picture details. Inactive pixels can occasionally appear on the screen represented by solid red, green, blue or black pixels (a maximum of 0.001% of the total number of pixels). Notice that this does not affect the LCD screen performance.

Notes on the USB connector:

- USB memory devices require being connected directly into the device. To prevent a failing or interrupting data transfer, do not use USB extension cable. Electrostatic discharge can cause the device to not function. In this case, the user must restart the device.
- Before using a USB memory device, test that it communicates with the device and its read and write speed.
- For maximum reading speed, we recommend to keep the disc space defragmented. Use file system FAT32, single partition, no protection. If the reading/writing of the memory device is not smooth, it can lead to undesirable effects, such as interruption of the image (blocky image) or failure of whole frames, audio malfunctions, and in

extreme cases, stopping of the operation. Unexpected behaviour of the memory device or the presence of viruses or other malware, may cause stopping of functioning of the device and need to be restarted.

- The USB connector is a standard type and cannot power a USB device with a high power consumption (e.g. hard drives). Use a device with its own power and power them with their own power supply.
- The device was designed for maximum compatibility with memory devices. Considering the variety of devices on the market, we cannot guarantee compatibility with every USB device available. Should you run into any issues, try formatting the memory device directly in the device. Should problems persist, use another memory device.

Due to the wide range of SD/MMC/MS cards/USB devices available on the market, we cannot guarantee compatibility with all types of SD/MMC/MS cards/USB devices.

Manufactured under license from Dolby Laboratories.

Dolby and the double-D symbol are trademarks of Dolby Laboratories.

Serial number

The device's serial number is a unique number that unambiguously identifies your device. Mark down the serial number of your device below along with additional information important for the unambiguous identification of your device.

Serial number: _____

Date of purchase: _____

Note:

1. The graphics in this manual is informative.
2. The menu on your TV screen may be slightly different from the illustrations in this manual.
3. The information in the document are subject to change without notice. The manufacturer accepts no liability for damages incurred directly or indirectly from errors, incompleteness or discrepancies between the instruction manual and the product described.

2. Functions and Features

Note:

Because of updates and improvements, the following descriptions may not match your TV set in the latest current version of the software. The described devices differ in location, design of controls and location of the connectors, besides differing in size. When operating the device pay attention to its actual design.

3. Device

Panel button

Note:

Pictures are for illustration only.

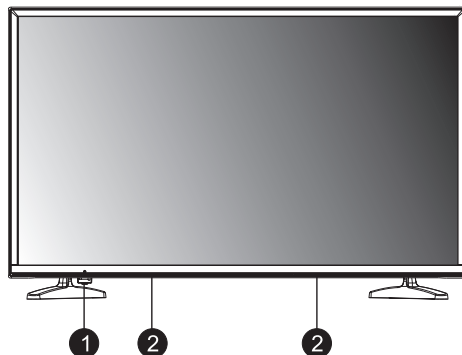

1. Power indicator / remote control sensor / directional controller + switching button
2. Speakers

3.1. Joystick control (only SLE 3258TCS)

Bottom view

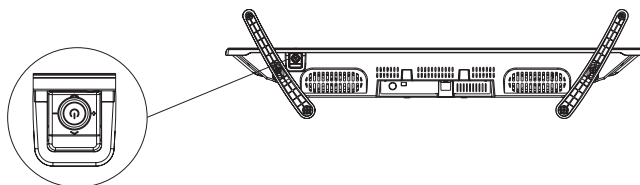

Press in medium position:

1. **Brief press** in the Standby mode will switch on the device.
2. **Long press** in the ON mode will switch off the device.
3. In the On mode and during regular watching (menu not shown) you can enter by **brief press** in the Menu of the device or confirm the selected item by OK (similarly like pressing Enter on the remote controller).
4. In the On mode and in the displayed menu, long press exits the device menu to regular watching or returns to the previous submenu/higher level menu (like pressing Menu on the remote controller).

Move left: moving in the menu to the left or lowering the volume

Move right: moving in the menu to the right or increasing the volume

Move forward: moving in the menu downward or going to a lower channel number

Move backward: moving in the menu upward or going to a higher channel number

Note:

To switch the input source select MENU/OPTION/SOURCE (Menu/Options/Source), select source and press the joystick in medium position (OK).

3.2. Button controls (only SLE 2464TCS)

Rear view

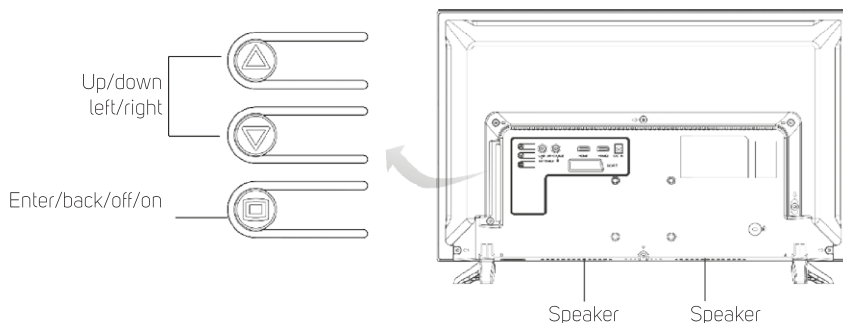



TV set on:





Press the button  and wait 2 sec.

TV set off:

Press and hold the button  2 sec.

Working in the menu:

Press briefly the button  and select using the buttons Up /Down  among Main menu, Input sources and Volume and enter the item with another press of the button .

BUTTON		MENU FUNCTIONS		
		Main menu	Menu Sources	Volume
Press		Left or up	Up	Left
		Right or Down	Down	Right
		Enter/Back (Back)	Enter/Back (Back)	–
Press and hold	 or 	Setting selection/value and confirmation	–	–

Connecting points

Note:

Pictures are for illustration only.

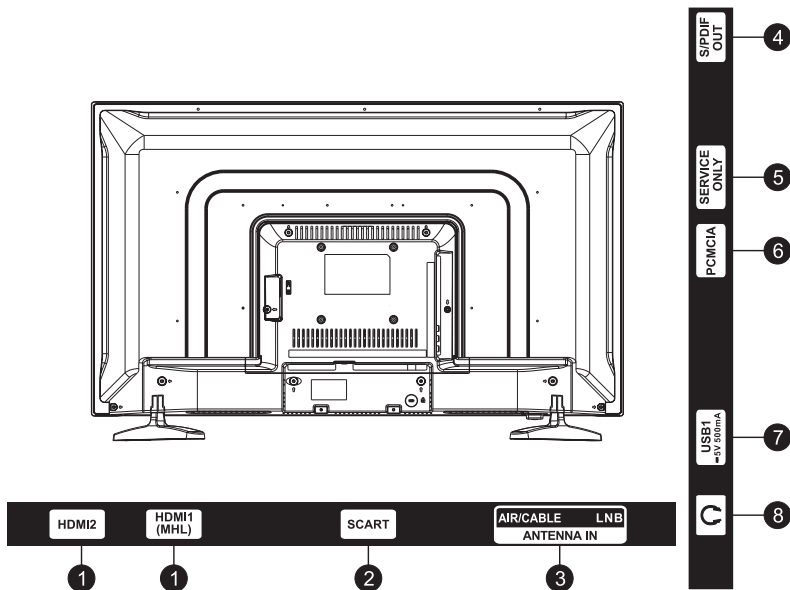

1. **HDMI1 (MHL)/HDMI2 IN:** Connection of the input HDMI signal from sources of signal, like a DVD player. HDMI1 supports the function MHL.
2. **SCART:** Port SCART.
3. **ANTENNA (AIR/CABLE/LNB) IN:** Connect antenna to TV for program tuning.
4. **S/PDIF OUT:** optical audio output for connecting a compatible amplifier.
5. **SERVICE ONLY:** Service port.
6. **PCMCIA:** CAM module connection
7. **USB1:** USB port.
8. **HEADPHONES:** Audio output: if the headphones are connected, the speakers switch off.

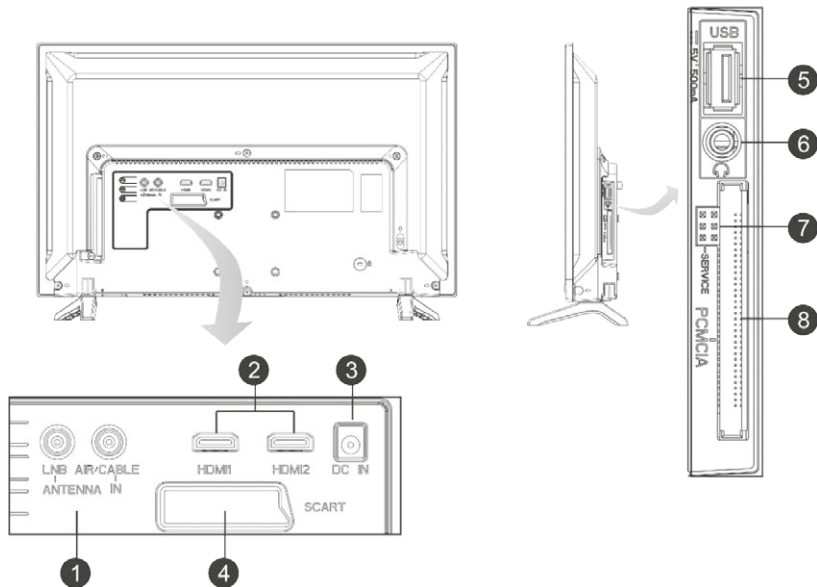

1. **ANTENNA IN:** Connection of an antenna to the TV set for tuning
2. **HDMI IN:** Connection of the input HDMI signal from the sources of the signal like for example a DVD player.
3. **DC IN:** connection of the power adapter
4. **SCART:** Port SCART.
5. **USB:** USB port.
6. **HEADPHONES:** Audio output: if the headphones are connected, the speakers switch off.
7. **SERVICE ONLY:** Service port.
8. **PCMCIA:** CAM module connection

4. Remote controller

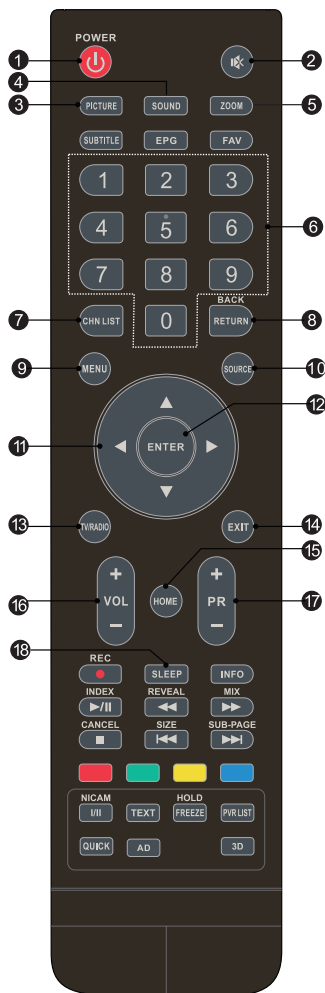

1. **POWER** (🔌)
Press to switch the TV on or switch to standby mode.
2. **Mute** (🔇)
Press to mute sound or to restore volume.
3. **PICTURE**
Changes the picture mode.
4. **SOUND**
Changes the sound mode.
5. **Zoom**
Changes the aspect ratio.
6. **Numerical buttons**
Direct channel selection.
7. **CHN LIST**
Press to display the channel list.
8. **RETURN**
Press to return to the previously viewed channel.
9. **MENU button**
Opens the menu.
10. **SOURCE**
Selection of input sources.
11. **Up/down/left/right (▲/▼/◀/▶)**
Navigating the menu.
12. **ENTER**
Selection confirmation.
13. **TV/RADIO**
Switching between television and radio.
14. **EXIT**
Leave the current menu.
15. **HOME**
Displays the home screen. This button will not work if your TV is not equipped with the HOME feature.
16. **Increase/decrease volume (VOL+/VOL-)**
Increase or decrease volume.
17. **Next/previous program (PR+/PR-)**
Switching channels forward or back.
18. **SLEEP**
Set sleep timer, for example to 10 minutes, 20 minutes, etc.

**19. EPG**

Press to display the electronic program guide in DTV mode.

20. SUBTITLE

Turn subtitles on / off in DTV / USB mode.

21. FAV. (Favourite channels)

Press to display your favourite channels.

Press up/down to browse through your favourite channels, confirm by pressing ENTER.

22. REC

Press to record the current program (only works in DTV mode).

23. INFO

Displays information about the current program.

24. USB control buttons**Play and pause (▶/⏸)**

Press to pause playback, press again to continue playing.

Stop (■)

Press to stop playback.

Fast rewind (◀◀)

Press to fast rewind.

Fast forward (▶▶)

Press to fast forward.

Previous (◀◀)

Press to play the previous file.

Next (▶▶)

Press to play the next file.

25. Color buttons

Press to perform quick functions in TV or DTV mode.

26. NICAM

Press to select the desired audio output depending on the broadcast channel.

27. FREEZE

Freezing the picture on the screen (it is not available in the USB mode).

28. PVR LIST

Displays the list of files with recordings.

29. QUICK

No function assigned.

30. 3D

No function assigned.

31. AD

Press to activate the audio description, the narrator describes what is happening on the screen for blind or visually impaired persons. Press again to switch off this function.



Teletext control buttons

32. TEXT

Press to enter or exit the teletext menu.

33. HOLD

Press to pause the teletext page on the screen without updates and changes. Press again to dismiss the hold.

34. Other buttons

SIZE

Zoom display of teletext: Press once to enlarge the top half of the screen. Press again to enlarge the bottom half of the screen. Press again to return to regular screen size.

REVEAL

Press this button to reveal hidden information, for example solutions to riddles and puzzles. Press again to conceal the information.

MIX

Press this button to blend teletext with TV broadcasting. Press again to return to the regular teletext mode.

SUB-PAGE

Press this button to activate or deactivate the sub-page mode (if a sub-page is available). Select the desired sub-page by pressing the red/green button.

INDEX

Press this button to display the content page.

CANCEL

Press this button to return temporarily to viewing television while a teletext page is loading from search. When the search is finished, the page number appears in the top left corner of the screen. Press again to return to the teletext page.

Inserting batteries into the remote controller

Insert two AAA batteries into the battery compartment of the remote controller. Mind the polarity of the batteries marked inside the compartment.

Note:

Pictures are for reference only. Actual systems may differ.

Slide the cover out horizontally.

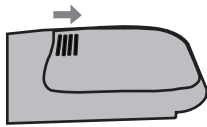

Insert two AAA batteries with the proper polarity.

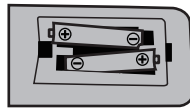

Slide the cover out in horizontally and close the cover.

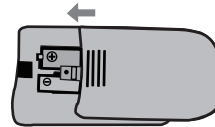

4.1. Electronic program guide (EPG)

EPG is a digital service that is delivered (exclusively) in the digital broadcasting by the program provider and offers information about the programs up to seven days in advance. The program provider is responsible for the amount and accuracy of the information. Time information about the programs applies to uniform time, it is therefore necessary to set the correct time of the TV set, incl. time zone, whether synchronized from broadcast or set manually.

EPG information is of two types. You can call up the information about currently broadcast program and following program by pressing **INFO** or **ENTER**, and then press the Right arrow. This information disappears in a while or you can suppress it by pressing again INFO/ENTER. Another type of EPG is the table of programs, which you call up by pressing **EPG** on the remote control.

1. Press **EPG** to display the EPG interface. The second line shows the current date and time, on the right the note Time. Currently viewed channel is highlighted in the list below. The list shows currently broadcast programs.
2. You can move down in the list of programs. If the data from a particular multiplex were not yet loaded, the screen shows "No information". Load the data by switching to any multiplex program; using the buttons ▲/▼ select the a multiplex program and press **ENTER** to view it.
3. If you want to find out about broadcasting of future programs, use the button **INDEX** to go to the header and press the ◀/▶ buttons to change the display to Channel. Press ▲/▼ to browse through programs and use the green button to view details (Info) of the selected program.

- In the list of programs of one channel (Channel table) you can switch between programs by moving into the line with the name of the program (**INDEX** and **Down**) and select a different program using buttons ◀/▶.
- Press **MENU** to exit EPG menu.

Note: programs data are broadcast for the entire **multiplex** (set of programs broadcast on the same frequency, e.g. 4–10 programs) and that happens periodically in few minutes intervals. TV reads the data and continuously displays them as soon as they are supplied. If the data are not complete, wait a while at one program without switching until the data are uploaded. The speed, accuracy and detail of the data depend on the broadcasting provider. Usually, it takes longer to transmit to you multiple data (longer texts).

EPG special functions are accessible using color buttons on the remote control:

Recorder

Press **red** to view the recording menu. Learn more in the section Recording, PVR. Do not forget to save each scheduled event by pressing **ENTER**.

Information

Press **green** button to view detailed information about a selected program. If it is longer, switch between the pages using **PR+** and **PR-**.

Time schedule

Press **yellow** button to view the list of your previously scheduled events. Recording has as a symbol camera, Reminders (only to watch) have an alarm clock symbol. Using buttons ▲/▼ you can select a scheduled event and delete it using the red button.

Reminders

Press **blue** button to view reminders menu, which is similar to recording, but serves only to remind you about the start of your selected program, without stopping time. However, the reminder time can be manually adjusted. Do not forget to save each scheduled event by pressing **ENTER**.

Tip:

TV's internal clock synchronize from the broadcast quite accurately. If the TV does not receive for a long time a broadcast with time, the internal clock can differ from real time and affect the accuracy of long-term scheduled events. To synchronize the TV clock switch on the TV set and wait a while.

5. Installation

Satellite dish setup for DVB-S broadcasting

SOURCE → **DVB-S** → **MENU** → **CHANNEL** → **Advanced Tuning**

Satellite dish setup (step 1–3, see fig. 1)

The satellite dish setup must be configured for each desired satellite before performing the channel search.

Satellite – select satellite for this TV.

LNB Type – make sure the type matches your LNB.

LNB Power – switching the LNB power supply on or off.

22KHz – choose 22kHz for enabling/disabling the 22K switch. Auto-mode for enabling and disabling the 22 kHz switch depending on the LNB type.

DiSEqC1.0/1.1 – select the DiSEqC mode for the chosen LNB converter.

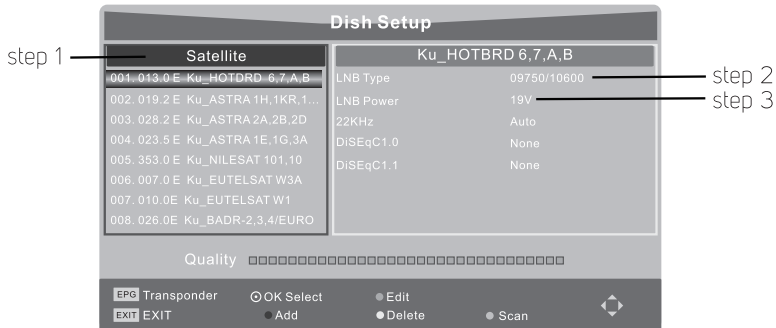

Fig. 1

step 1 Highlight the **Satellite** and press **ENTER** to navigate to the list of satellites and select one.

step 2 Highlight the **LNB Setting** and press **ENTER** to navigate to the LNB setup.

step 3 Make sure the **22kHz** and **DiSEqC1.0/1.1** switches match the selected satellite.

After following the procedure above, press the blue button and the channels will begin to tune.

Advanced DVB-S tuning (requires technical data from your reception provider)

When you enter the list of the transponders by pressing the EPG button and do not select (ENTER) any transponder (just highlighting is not enough), the tuning process will proceed for all items in the list. If you only choose one transponder of a single satellite, the programs found will be added to the end of the existing list. If you choose more than one transponder, your existing list will be deleted and only the newly found transponder and satellite programs, selected to be searched, will be stored.

Tip:

Full-satellite tuning can result in a very large list of channels, which is difficult to orient yourself in. This can be avoided by tuning the desired transponders one by one (channels will be added). Or for example using a network tuning of one satellite and "additional tuning" of several transponders from other satellites. This allows storing a reasonably large list of channels.

Example for Skylink Czech Republic: Advanced Search/Astra 23.5E/Transponder (EPG)/12071H/Tuning (blue)/Search Type=Network/Enter. (According to the operator table, the receiver will find and store programs for the entire satellite). Check the parameters for transponders stored in this manner, in particular symbol speeds that differ from 27.5 Msym/s, or adjust to their actual speeds 29.5 and 29.9 Msym/s, where these are different for programs on-demand than specified in the broadcast table. Tune each transponder one by one from the Astra 19.2 E satellite provided you would like to receive the programs offered by this satellite and that you have a compatible satellite antenna.

**NOTICE:**

Have a professional install your satellite antenna to ensure you get quality and uninterrupted reception. The professional will inform you about the technical parameters (in particular DiSEqC), which he used during the installation process and which shall be entered into the TV receiver for a successful tuning process.

6. Video Recording (PVR)

IMPORTANT NOTICE:

1. All types of recording required an external device, to which content will be recorded, be connected to the appropriate USB port on the rear side of the TV.
2. The USB device must use the FAT32 file system.
3. We recommend formatting the USB device in the TV before using the USB device for recording on this TV.
4. Make sure "DTV" is selected as the input source.

6.1. Quick recording and playing with a press of a button

1. Connect an external high-speed storage device and make sure there is enough free capacity.
2. Select the TV channel and the program which you want to record.
3. Press **REC** to go to the PVR mode and start recording. A panel with PVR controls will appear where you can configure the settings.



4. If the PVR function is not available, try formatting the USB device.
5. If you would like to stop recording, press [■] and the recording stops.

Note on the recording information and control panel (see fig.):

When recording a program or timeshift viewing, a toolbar will appear with information about the selected program, the current time, recording duration and maximum duration available (according to your setup and free space on your data storage, the duration is estimated according to the type of broadcast and resolution). The toolbar also contains controls for basic functionality – play, pause, stop, fast forward and rewind. These functions can be activated by the arrow keys on the remote control and pressing **ENTER** or the corresponding keys on the remote control.

You can hide the toolbar by pressing **DOWN** and display the toolbar again by pressing the same button. When the toolbar is hidden, the mode is indicated by a small symbol shown in the top left of the screen.

Note:

- (A) In the recording mode you cannot change channels or select another function.
- (B) If the signal is interrupted or disconnected during recording, recording stops until the signal is restored. This may cause loss of content of the program.
- (C) Do not switch off the TV during recording. The TV stops the PVR function and switches to standby.

6.2. Recording Timer

There are two ways to set the timer for television program recording.

If you know the details about the program:

1. Switch to the channel on which the recorded program will be showed.
2. Press **EPG** on the remote controller and the EPG interface will appear. The channel which you are watching will be highlighted on the screen.
3. Press the **red** button on the remote control, then enter the details of the program in the menu of the recorder using **▲/▼** for button selection **◀/▶** to change the settings. For example, if the program begins at 20:30 on the same day, enter: 30 in the minutes field, 20 in the hours field (applies for 24-hour time format), and then the respective date. Use the same method for entering the end time.
4. Select the corresponding recording mode: once, daily or weekly.
5. Press **ENTER** to confirm the selection. Displays the schedule of all of your recordings (list of times). More information about the schedule can be found in the EPG description.

If you are navigating through the RPG, follow the instructions on which the EPG functions are described.

Recording, PVR

To ensure successful use of the PVR function, it is important for the combination of read and write speed to be compatible with the current type of digital broadcasting and its speed multiples. For maximum USB memory performance, we recommend formatting your memory device in the TV. One of the available options is FAT32, which you can use more easily if you also use the memory device with a computer. Allocating more space gives you more freedom in using PVR functions, but it also slows down access to necessary data due to the bus speed on the drive. Check your drive to see whether it supports PVR functions, the TV checks both the file system and drive speed, which is essential for successful PVR operations. Speed is classified into classes, e.g. Full HD support, HD support, SD support, SD fail. If the speed of your drive, for example, is insufficient (SD support only) and you are attempting to record an HD program, based on the current broadcast speed, the TV either displays an insufficient drive speed message (demonstrated after experiencing failures during the recording process) or completely stops recording. The speed of the broadcast and of the disc is evaluated continually and a message about the speed can appear at any time (repeatedly) during recording. When this happens often, use faster disc or reformat it.

Timeshift

Timeshift is a special type of recording digital broadcasts, used to stop the currently viewed broadcast (e.g. to have a coffee) and resume viewing without having to miss the part of the program shown while you were not by the screen.

Enter the mode by pressing **RECORD** and **PLAY/PAUSE** (switch to timeshift mode). Press **PLAY/PAUSE** again to stop the program and record in the background. Once you return to the screen, press **PLAY/PAUSE** again and resume playback. You can fast forward and

rewind through a recording (provided the write speed of your USB memory drive permits) at multiple speeds by repeatedly pressing FFWD/REV. Press STOP to stop timeshift mode (return to real time broadcasting) and press STOP again to stop recording completely.

**NOTICE:**

When recording or timeshift viewing channels protected by conditional access, your conditional access system can restrict processing according to your conditional access rules. For example, recording programs to be viewed later is different from viewing programs in real time and the stored time code can limit or prohibit your actions. Do not violate copyright laws. The system can refuse to record programs even considering the parameters of connected memory or special protective broadcasting functions of both the entire program and individual programs or program segments (for example due to age or regional restrictions). Please contact your conditional access system provider for more information.

7. Menu Setup

Menu controls (DTV mode)

Press "MENU" to open the main menu.

Press [◀] / [▶] to select an option.

Press "ENTER" to confirm the option.

Press [◀]/[▶]/[▲]/[▼] and press ENTER to select submenus.

Press "MENU" to leave the option.

7.1. Picture

Picture Mode

Selecting the mode of automatic control of the picture. Available options include Dynamic, Standard, Mild and User.

Color Temperature

Overall color tone setup. Available options include Cool, Medium, Warm and User.

Aspect Ratio

Select the aspect ratio (the proportions of the picture) according to the type of video or custom preferences. Available options include 4:3 / 16:9 / Just Scan / Zoom2 / Zoom1. (Note: some options may not be available from some sources.)

Noise Reduction

Eliminates noise from the picture. Available options include Off / Low / Middle / High. (PC cannot be used as source)

MPEG Noise Reduction

Eliminates noise generated when creating the digital video signal. Available options include Off / Low / Middle / High. (PC cannot be used as source)

7.2. Sound

Sound Mode

Select your favourite sound mode for each input. Available options include Standard / Music / Movie / Sports / User.

Bass

Setting lower sound frequencies.

Treble

Setting higher sound frequencies.

Balance

Controlling the sound balance between the left and right speakers (headphones).

Auto Volume

Setting the volume corresponding to the input sound level. Available options include On and Off.

Surround Sound

Activates the Sound Retrieval System.

AD switch

Activate audio description; can be activated under audio description volume settings. When the audio description is activated, the narrator describes what is happening on the screen for blind or visually impaired persons.

S/PDIF Mode (S/PDIF mode)

PCM or Auto mode at the digital audio output.

7.3. Channel

Auto Tuning

Select from the available options, DVB-T or DVB-C and press **ENTER** to go to the next step, then choose the country or type of tuning and then search and automatically store the programs. If you want to stop the auto tuning process, press **MENU** or **EXIT**. The exit dialog will appear.

Press ◀ to confirm exit.

Press ▶ to continue searching.

Advanced Tuning

Use for setting the parabola, see SATELLITE DISH SETUP.

DTV Manual Tuning

Manual tuning and storing programs. Channel → DTV Manual Tuning

Select the type of source (DVB-T or DVB-C) and manually tune digital channels. In the menu Channel select the item **DTV Manual Tuning** and open the menu by pressing **ENTER**.

1. Press ◀ or ▶ to select the **channel number** and press **ENTER** to start the tuning.
2. Searching stops when a channel is found, and this channel is saved to the current channel position. If you want to stop the search, press **MENU**.

ATV Manual Tuning

First select the type of ATV source. In the menu Channel select the item **ATV Manual Tuning** and open the menu by pressing **ENTER**.

1. Mark and press ▲ or ▼ to select the option **Storage To 1** (or under another number), **Sound System** and **channel no.** (channel number). Then highlight the item **Search** and press **ENTER** to start searching.
Press ▶ to search in the direction towards higher frequencies; press ◀ to search in the direction towards lower frequencies;
2. Searching stops when a channel is found, and this channel is saved to the current channel position. If you want to stop the search, press **MENU**.

Fine Tuning

Used to fine-tune individual channels. Fine-tuning is not necessary under normal circumstances. However, use it in areas with impaired reception, where adjustments are necessary in order to achieve better video and audio.

1. Select the channel, which you want to fine-tune.
2. In the menu **Channel** select the item **ATV Manual Tuning** and using ▼ highlight the item **Fine Tuning**.
3. Press ◀ or ▶ to fine tune in order to achieve the best video and sound.

Program Edit

Channel editing. Use the color keys on the remote control to skip, rename, delete or move channels, and add to the list of favourites by pressing FAV.

Changing the order of channels

We recommend to first choose good method for Sorting (green) in the general list (**CHNLIST**), e.g. according to the channel name. Then navigate to channel editing (MENU/Channel/Edit Channels) and use the FAV button to identify your favourite channels (red heart symbol). We recommend using the favourite channel list **FAV** for longer lists (typical for satellite channels).

You can browse through channels. If you want to check whether you receive a certain channel (pre-paid), hover over the channel with the cursor and press ENTER – information about the reception status. Programs can be deleted one after another by pressing the **red** button. Use the **blue** button to identify a channel to be skipped, when browsing through channels pressing PR+/- . Use the **yellow** button to select a specific channel to move, and move the channel Up/Down in the channel list. When you have arrived at the position you wish to store the channel, press the yellow button again.

Notice on reordering your list:

The reordering of channels in the list takes time, please be patient. Remember that ordering the channels also renumbers channels according to what you have specified. As soon as the channels are ordered based on your needs, do not re-order – green button in the channel list, otherwise you would “lose” your order.

Signal Information

Displays information about the current DTV channel.

CI Information

Allows the user to select from the CAM-provided menu. Select the CI menu found in the PC Card menu.

5V Antenna Power

This option is only available for DVB-T sources. Select **On** to power the TV antenna; select **Off** to disable this function.

7.4. Options

Note:

Functions vary with different sources, images differ from the actual screen and are for reference only.

OSD language

Select the desired OSD language.

Audio Languages / Subtitle Languages (note 1)

Select according to your preferences.

TTX language

Select the teletext language for various regions.

Time

Auto-sync, time, time zone, summer time, sleep timer and auto-off settings can be configured.

HDMI CEC

Press to navigate to submenus.

HDMI CEC – switching on or off the HDMI CEC function.

Auto Standby – automatic switch of the TV into standby mode.

Auto TV on – when a CEC device is activated, the TV will automatically turn on.

Device List – if the HDMI CEC is on, you can check the list of the devices connected to the TV.

PVR File System (note 1)

Video recording settings. To use this feature, you must receive digital broadcasts and connect a USB disk.

Restore Default

Restoring factory defaults from user settings.

Source

Option to switch the input source in the menu of the device (suitable for joystick control).

Software Update (USB)

Connect a USB device with software containing the upgrade for the TV system upgrade.

Note:

The functions Audio Language / Subtitle language / PVR File System work only with the sources DVB / DTV.

7.5. Lock

Lock System

Switching lock system on or off.

Set Password

Restore password (the original password is 0000 and the master password is 8899).

Block Program

Setting blocked programs as needed.

Parental Guidance

Setting channels appropriate for child viewing.

Hotel Mode

Special setting for use in hotel operations, incl. saving of the program list.

Note:

Turned on Hotel Mode removes from the menu the option Restore to factory settings and Software updates (above).

8. USB CONTROL

Note for using a USB player

1. Some USB storage devices may not be compatible and work smoothly with this TV.
2. Backup your data on a USB memory device in the event of accidental data loss.
We are not liable for losses caused by improper use or malfunction. The customer is responsible for data backups.
3. In the case of large files the loading time can be slightly longer.
4. The recognition speed of a USB storage device depends on each device.
5. When connecting or disconnecting the USB storage device, make sure the TV is not in USB mode. Doing so may damage the memory device or files stored on it.
6. Only use USB storage devices formatted in FAT16, FAT32, NTFS file systems provided with the operating system Windows. Memory devices formatted to a file system that is not supported by Windows may not be recognized.
7. When using a hard drive with the USB interface, which requires a power source, ensure that the power does not exceed 500 mA. If the power supply to the hard disk with USB interface exceeds 500 mA, the TV switches to standby mode. The hard disk with USB interface shall be disconnected followed by a restart of the TV set. If a file that is an unsupported format or damaged is found, the message **"Unsupported File"** will appear on the screen.

Support for playback of files from USB devices

Video

File type / (extension)	Video type	Audio type	Note
MP4, MOV / (.mp4, .mov, .m4v)	Motion JPEG MPEG-4 SP/ASP (XviD)	MPEG-AUDIO	
AVI / (.avi)	Motion JPEG MPEG-4 SP/ASP (XviD)	LPCM MPEG-AUDIO	
ASF / (.wmv3, .xvid)	MPEG-4 SP/ASP (XviD)	MS-ADPCM, Intel-ADPCM	
MKV / (.mkv, .xvid)	MPEG-4 SP/ASP (XviD)	MPEG-AUDIO	
TS / (.ts/trp)		LPCM MPEG-AUDIO	
DAT, MPG, MPEG / (.dat, .mpg, mpeg)		LPCM MPEG-AUDIO	
VOB / (.vob)		LPCM MPEG-1 Layer2	
MP4, MKV / .mp4, .mkv	HEVC		Bit rate ≤ 30 mb/s, 1080p

Music

File type	File extension	Supported version	Note
Mpeg-1 Layer 3			
	wma	LPCM	WMA 7~9.1 is WMA2
MPEG-1/2 Layer 1/2	not available (only included in video)	MPEG1/2	
LPCM	not available (only included in video)		
AAC	aac, mp4, m4a		The customer must purchase a license. AAC variable data flow: only fast forward at speeds of 1.5x~2x; m4a format cannot be fast forwarded or rewind; ADTS format can be fast forwarded and rewind

Photos

File type	File extension	Supported version	Note
JPEG	jpg/jpeg		
BMP	bmp		supports all modes
PNG	png	MPEG1/2	interlacing support, animation mode not supported

8.1. USB menu

Press Source and select the USB option. You can watch a video, play music and view photos stored on USB memory devices.

1. Connect the USB memory device to the USB input and select the type of media on the home screen: VIDEO, MUSIC and PHOTO.
2. Press **ENTER**; the connected USB device will appear on the screen. Press **ENTER** again to display the folders and files.
3. Press [◀] / [▶] or [▲] / [▼] to select a folder. Press **ENTER** to open a folder and select the files, then check the files by pressing **ENTER**. Then mark the file to be played first and press [▶/||] to start playback; or select a file and press [▶/||] to directly start playback.
4. Press [■] to stop playback and return to parent folder.
5. Press and hold **RETURN** to return to the parent folder.
6. Repeat the process to select and play a different type of media.

8.2. Movie playback

Press **INFO** / [▼] to display /exit the following menu bar. Use the USB device control on the remote controller to perform actions within the menu.

Movie control bar

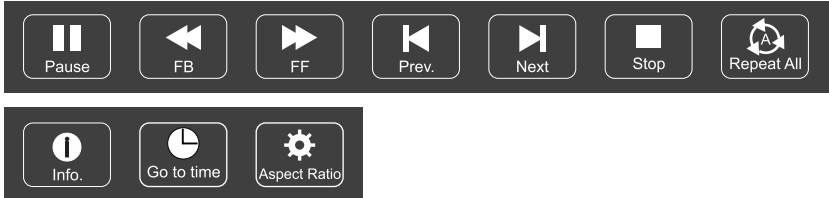

Play and pause / Stop / Previous / Next

Press [▶/⏸] to start or pause playback; press [■] to stop playing; press [◀] / [▶] to play the previous or the next video file. You can also use [◀] / [▶] to mark one of four icons and then press **ENTER**. The TV will respond accordingly.

Fast forward / Rewind

Press and hold [◀◀] / [▶▶] for several seconds to move the playback as you require; then press [▶/⏸] to start playback from the new position.

Playback mode

Select the appropriate icon and press **ENTER** to switch to another playback mode.

Information

Select an icon and press **ENTER** to view information about the played video.

Jump to time entered

Skipping to specific position by entering the time. Select the appropriate icon and press **ENTER** to open the screen on which the time can be entered. Press [◀] / [▶] to move the cursor and use the numerical buttons to enter the time. Press **ENTER** and the TV starts playing from the set time.

Aspect ratio

Select the button and press **ENTER** to select the display mode.

8.3. Music playback

Press **INFO** / [▼] to display /exit the following menu bar. Use the USB device control on the remote controller to perform actions within the menu.

Music control bar



Play and pause / Stop / Previous / Next

Press **▶/||** to start or pause playback; press **■** to stop playing; press **⏮** / **⏭** to play the previous or the next track. Or press **◀** / **▶** to mark the respective icon on the control panel and then press **ENTER**. The TV will respond accordingly.

Fast forward / rewind

Press and hold **⏮** / **⏭** for several seconds to move the playback as you require; then press **▶/||** on the remote controller to start playback from the new position.

Playback mode

Mark the icon and press **ENTER** to switch to another playback mode.

Information

Select an icon and press **ENTER** to view information about the played track.

Note:

- This menu displays only supported files.
- The files with different extensions will not be displayed, although they are stored on the same USB memory device.
- A remodulated MP3 file may cause sound distortion during playback.
- This TV supports song lyrics display (in English). The maximum number of characters per line is the 48.
- To display text during song playback, the file names with songs and lyrics must be the same.
- To view the lyrics of related songs on the screen, you need these associated texts stored in the same folder and with the same file name with the extension .lrc.

8.4. Viewing photos

Press **INFO** / **▼** to display /exit the following menu bar. Use the USB device control on the remote controller to perform actions within the menu.

Photo control bar

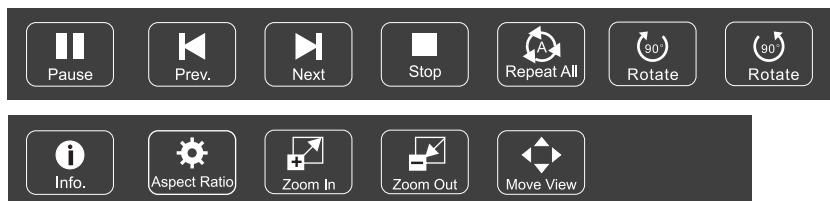

Play and pause / Stop / Previous / Next

Press **[▶/||]** to start or pause browsing; press **[■]** to stop browsing; press **[◀] / [▶]** to display the previous or the next photo. Or press **[◀] / [▶]** to mark the respective icon on the control panel and then press **ENTER**. The TV will respond accordingly.

Playback mode

Mark the icon and press **ENTER** to switch to another playback mode.

Rotate

Select the icon from the menu panel and press **ENTER** to rotate the picture by 90° clockwise or counterclockwise.

Information

Select the appropriate button and press **ENTER** to view information about the displayed photo.

Aspect ratio

Select the button and press **ENTER** to select the display mode.

Zoom in/out

Select the appropriate icon on the menu bar and press **ENTER** to zoom in/out of the picture.

Moving within a picture

Use this function for convenient viewing when the picture is enlarged. Mark this icon, press **ENTER** and then move throughout the picture by pressing left/right/up/down.

Note:

The Move  function is only available when a picture is zoomed in.

9. Troubleshooting

Read the following information, which describe the possible causes and solutions to a problem you have run into before you call a service technician.

NO VIDEO, NO AUDIO

1. Check the fuse or electric switch.
2. Connect other electronic devices into the outlet to determine whether it operates or is connected.
3. Bad contact between plug and outlet.
4. Check the signal source.

MISSING COLORS

1. Change the color system.
2. Adjust the Auto-tune saturation.
3. Try another channel. It may be a black and white program.

REMOTE CONTROLLER DOES NOT WORK

1. Replace batteries.
2. Batteries are incorrectly inserted.
3. Power is not connected.

NO VIDEO, NO AUDIO

1. Adjust the brightness and the contrast.
2. Broadcasting may be interrupted.

NORMAL VIDEO, NO AUDIO

1. Press the button to raise volume.
2. Volume is on mute, press MUTE to restore sound.
3. Change the sound system.
4. Broadcasting may be interrupted.

WAVES IN PICTURE

Usually caused by local interference, such as cars, lights and hair dryers. Adjust the antenna to minimize interference.

SNOW AND INTERFERENCE

If the antenna is located at the fringe area of TV signal reception, where the signal is weak, the image and sound may be distorted in some areas. If the signal becomes extremely weak, you may have to install a special antenna to improve reception.

1. Adjust the position and orientation of the indoor / outdoor antenna.
2. Check the antenna connection.
3. Fine tune the channel.
4. Try another channel. Broadcasting may be interrupted.

IGNITION

Black spots or horizontal stripes appear, or the picture is shaky and interrupts. This is usually caused by vehicle ignitions, neon lights, power drills and other power tools.

SHADOWS

Shadows are a result of a TV signal coming from two routes. One is direct and the second is reflected from high buildings, hills and other objects. Reception can be improved by adjusting the antenna direction or placement.

HIGH FREQUENCY INTERFERENCE

This interference is caused by waviness or diagonal stripes and in some cases by the loss of picture contrast. Find and eliminate the source of radio interference.

Note:

If the problem persists, refer to your local service centre.

10. Technical specifications

Model	SLE 2464TCS	SLE 2464TCS
Panel size	24" (60 cm)	32" (81 cm)
Power consumption	40 W	65 W
Standby consumption	<0,5 W	<0,5 W
Rated voltage	12 V DC, 3 A	100 - 240 V AC, 50/60 Hz
Remote controller	Yes	Yes
VESA wall mount	75 x 75	100 x 100
Dimensions with stand (w x h x d)	553.5 x 131 x 364 mm	735 x 191 x 468 mm
Dimensions without stand (w x h x d)	553.5 x 56 x 338,5 mm	735 x 86 x 434 mm
Net weight with stand	2,3 kg	4,3 kg
Connection		
RF IN	1	1
SCART	1	1
HDMI	1	2
SPDIF coaxial		1
USB	1	1
Supported USB formats	HEVC, MKV, AVI, MP4, MPEG, FLV, MP3, WMA, JPEG, JPG, PNG, BMP	HEVC, MKV, AVI, MP4, MPEG, FLV, MP3, WMA, JPEG, JPG, PNG, BMP
CI slot	1	1
Other functions		
WXGA resolution	1366 x 768	1366 x 768
Brightness (cd/m ²)	200 cd/m ²	220 cd/m ²
Aspect ratio	16:9	16:9
Dynamic contrast	1,000,000:1	1,000,000:1
Response time (ms)	14	8
Viewing angle	176°/176°	178°/178°
Embedded tuner	DVB-T/T2, DVB-C, DVB-S/DVB-S2	DVB-T/T2, DVB-C, DVB-S/DVB-S2
Video system	PAL/SECAM BG/DK/I	PAL/SECAM BG/DK/I
PVR recording to USB	Yes	Yes
Progressive scan	Yes	Yes
Timeshift	Yes	Yes
EPG	Yes	Yes
Comb filter	Digital	Digital
OSD menu	EN, CZE, POL, HUN, SVK, GRC, ROM, BUL, HRV, SLV SRB	EN, CZE, POL, HUN, SVK, GRC, ROM, BUL, HRV, SLV SRB
Zoom	Yes	Yes
Noise reduction	Yes	Yes
Timer OFF / ON / SLEEP	Yes	Yes
Subtitles	Yes	Yes
Audio language	Yes	Yes
Channel list	Yes	Yes
Favourites list	Yes	Yes
Image freeze	Yes	Yes
Radio	Yes	Yes
Lock	Yes	Yes
Parent lock	Yes	Yes
Hotel mode	Yes	Yes

Environment (only for mild climate zone):

Operating temperature: 5 °C ~ 35 °C

Operating humidity: 20 % ~ 80 %

Storage temperature: -15 °C ~ 45 °C

Storage humidity: 10 % – 90 %

Channel coverage:

DVB-T/T2: 174 MHz – 230 MHz; 470 MHz – 860 MHz;

DVB-C: 50 MHz – 858 MHz

DVB-S/S2: 950 MHz – 2150 MHz

System:

DTV: DVB-T/T2, DVB-S/S2, DVB-C

ATV: PAL/SECAM (BG/DK/I)

AV: PAL, NTSC

Channel pre-sets: ATV: 100, DVB-T/ DVB-C: 600; DVB-S: 1,900

Status display method: On-screen menu

Function settings indicator: Display menu

On-screen menu language: More options

Antenna input: 75 Ω asymmetrical

AV video in: 75 Ω , 1.0 V_{p-p}

AV audio in: 10 k Ω , 0.5 V_{rms}

Note:

Technical specifications may change without prior notice.

The original version is in Czech.

Manufacturer address: FAST ČR, a.s, Černokostelecká 1621, 251 01 Říčany, Czech Republic

Information sheet

Importer: **FAST ČR, a.s., Černokostelecká 1621, 251 01 Říčany**

Symbol		Sencor	Sencor
Model		SLE 2464TCS	SLE 3258TCS
Energy efficiency class		B	A
Screen diagonal in cm / inches	[cm/"]	60/24	81/32
Electric energy consumption when on	[W]	34	39
Annual electric energy consumption*	[kWh]	50	57
Electric energy consumption in standby mode	[W]	≤0.5 W	≤0.5 W
Screen resolution	[pixels]	1366 × 768	1366 × 768

* Electrical energy consumption 50 kWh (SLE 2464TCS), 57 kWh (SLE 3258TCS) per year is based on the electricity consumption of a TV set operating 4 hours per day for 365 days. The actual electric energy consumption will depend on how the television is used.

INSTRUCTIONS AND INFORMATION REGARDING THE DISPOSAL OF USED PACKAGING MATERIALS

Dispose of packaging material at a public waste disposal site.



DISPOSAL OF USED ELECTRICAL AND ELECTRONIC APPLIANCES

The meaning of the symbol on the product, its accessory or packaging indicates that this product shall not be treated as household waste. Please, dispose of this product at your applicable collection point for the recycling of electrical & electronic equipment waste. Alternatively in some states of the European Union or other European states you may return your products to your local retailer when buying an equivalent new product.

The correct disposal of this product will help save valuable natural resources and help in preventing the potential negative impact on the environment and human health, which could be caused as a result of improper liquidation of waste. Please ask your local authorities or the nearest waste collection centre for further details. The improper disposal of this type of waste may fall subject to national regulations for fines.

For business entities in the European Union

If you wish to dispose of an electrical or electronic device, request the necessary information from your seller or supplier.

Disposal in other countries outside the European Union

If you wish to dispose of this product, request the necessary information about the correct disposal method from local government departments or from your seller.



This appliance complies with EU rules and regulations regarding electromagnetic and electrical safety.

Changes to the text, design and technical specifications may occur without prior notice and we reserve the right to make these changes.

SENCOR®

EN Warranty conditions

Warranty card is not a part of the device packaging.

This product is warranted for the period of 24 months from the date of purchase to the end-user. Warranty is limited to the following conditions. Warranty is referred only to the customer goods using for common domestic use. The claim for service can be applied either at dealer's shop where the product was bought, or at below mentioned authorized service shops. The end-user is obligated to set up a claim immediately when the defects appeared but only till the end of warranty period. The end user is obligated to cooperate to certify the claiming defects. Only completed and clean (according to hygienic standards) product will be accepted. In case of eligible warranty claim the warranty period will be prolonged by the period from the date of claim application till the date of taking over the product by end-user, or the date the end-user is obligated to take it over. To obtain the service under this warranty, end-user is obligated to certify his claim with duly completed following documents: receipt, certificate of warranty, certificate of installation.

This warranty is void especially if apply as follows:

- Defects which were put on sale.
- Wear-out or damage caused by common use.
- The product was damaged by unprofessional or wrong installation, used in contrary to the applicable instruction manual, used in contrary to legal enactment and common process of use or used for another purpose which has been designed for.
- The product was damaged by uncared-for or insufficient maintenance.
- The product was damaged by dirt, accident of force majeure (natural disaster, fire, and flood).
- Defects on functionality caused by low duality of signal, electromagnetic field interference etc.
- The product was mechanically damaged (e.g. broken button, fall).
- Damage caused by use of unsuitable media, fillings, expendable supplies (batteries) or by unsuitable working conditions (e.g. high temperatures, high humidity, quakes).
- Repair, modification or other failure action to the product by unauthorized person.
- End-user did not prove enough his right to claim (time and place of purchase).
- Data on presented documents differs from data on products.
- Cases when the claiming product cannot be indentified according to the presented documents (e.g. the serial number or the warranty seal has been damaged).

Authorized service centers

Visit www.sencor.eu for detailed information about authorized service centers.

SENCOR®

Let's live!

www.sencor.cz

Designed in Europe by Sencor®, Made in China

