

# Xelos

TV

Xelos 46,  
Xelos 40,  
Xelos 32



Operating instructions

**LOEWE.**

233-35024.021



# Overview of the most important functions

## Set operating mode



TV operation



Radio operation (standard assignment)  
The assignment of the AUDIO button can be changed (see page 95).

## On/Off of the television set



On/Off device in standby  
(Main switch must be turned on)

## Selecting stations



**OK** Call station overview and with  
◀ ▶ ▲ ▼ Select station



or

**P+/P-** Next/ previous channel

or



Select station with numeric buttons

## Sound



**V+/V-** Increase/ reduce volume



Sound on/off

## Colour key function during TV operation



**Red button:** Start HbbTV or interactive data service

**Green button:** Teletext subtitles

**Yellow button:** Last selected station

**Blue button:** Programme information

## Colour key function during radio operation



**Red button:** On/Off screen

**Yellow button:** Select previous station

## Button functions



Call MediaPortal



with on-screen display: Info display,  
info text appropriate to the content that can assist you  
further, should you have any questions about your TV  
device;

without on-screen display: Access status display,  
show the programme information (if present) when the  
status window is open and the button is repeatedly pressed



Call archive <sup>(1)</sup> / timer list

Press button twice in quick succession:  
Show / hide time permanently



Adjust picture format



On/Off EPG (Electronic Programme Guide)



On/Off teletext / MediaText



Call menu



With opened menu: Exit menu;  
Terminate inserts

<sup>(1)</sup> Only if a USB storage device is connected.

# Remote control – TV functions

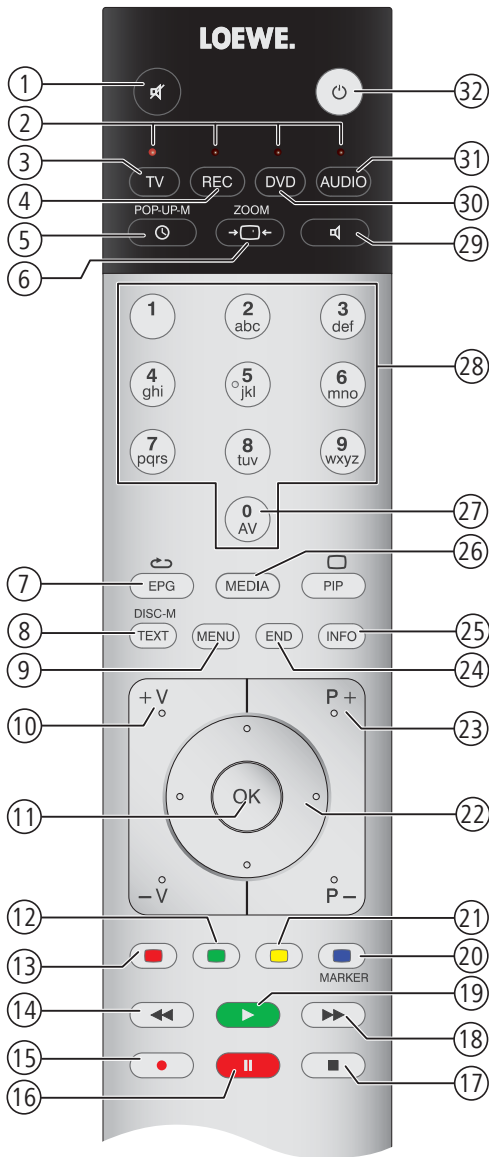

- ① Sound off/on ..... (page 33)
- ② LED display for current operating mode ..... (page 95)
- ③ Switch over to TV mode ..... (page 20; 95)
- ④ Switch over to operate recorder<sup>12</sup> ..... (page 95)
- ⑤ Call archive<sup>1</sup> / Timer list on/off / Permanent display of time ..... (page 69; 77; 38)
- ⑥ Set picture format ..... (page 36)
- ⑦ Electronic Programme Guide on/off ..... (page 45)
- ⑧ Teletext on/off ..... (page 47)
- ⑨ Menu on/off ..... (page 12)
- ⑩ **V+V-** Increase / reduce volume ..... (page 33)
- ⑪ Station list on ..... (page 31)  
in the menu: Confirm/call ..... (page 12)
- ⑫ Green button: Teletext subtitles ..... (page 37)
- ⑬ Red button: Start interactive data service ..... (page 37)
- ⑭ Select station down / Jump<sup>1</sup> / Rewind<sup>1</sup> ..... (page 81)
- ⑮ Direct recording<sup>1</sup> ..... (page 78)
- ⑯ Timeshift television<sup>1</sup> ..... (page 78)
- ⑰ End timeshift<sup>1</sup> / End archive playback<sup>1</sup> ..... (page 78)
- ⑱ Select station up / Jump<sup>1</sup> / Fast forward<sup>1</sup> ..... (page 81)
- ⑲ Continue (time shift viewing) ..... (page 78)
- ⑳ Blue button: Programme info on/off ..... (page 37)
- ㉑ Yellow button: Switch to the last viewed channel ..... (page 37)
- ㉒ In the menu / in lists: Select/Set ..... (page 12)
- ㉓ **P+P-** Select Station up/down ..... (page 31)
- ㉔ Close all displays ..... (page 12)
- ㉕ Status display on/off / in the menu: context-relevant Info on/off ..... (page 39; 15)
- ㉖ MediaPortal on/off ..... (page 14; 56)
- ㉗ AV selection ..... (page 32)
- ㉘ Select station directly; in the menu: Enter numbers or letters ..... (page 31)
- ㉙ Set sound adjustment ..... (page 33)
- ㉚ Switch over to operate DVD player<sup>12</sup> ..... (page 95)
- ㉛ Switch over to radio mode<sup>12</sup> ..... (page 21; 48; 95)
- ㉜ Switch on / off to standby mode ..... (page 21)

<sup>1</sup> Only if a USB storage device is connected.

<sup>2</sup> The assignment of this key can be changed (see page 95).  
The description refers to the standard setting.

The key assignment displayed here is valid for the main menu level of the TV set. The key assignment may vary in certain operating modes (see the corresponding chapter in this operating manual).

## Acknowledgements

Loewe Opta GmbH  
Industriestraße 11  
D-96317 Kronach  
www.loewe.de

Printed in Germany  
Date of issue 05/12-2.0 TB/FP  
© Loewe Opta GmbH, Kronach  
ID: 2.2.4b

All rights including translation, technical modifications and errors reserved.



# Contents

<b>Overview of the most important functions</b> .....	<b>2</b>	<b>Daily operation</b> .....	<b>31</b>
<b>Remote control – TV functions</b> .....	<b>3</b>	Select station .....	31
<b>Acknowledgements</b> .....	<b>4</b>	Selecting Audio/Video Source .....	32
<b>Welcome</b> .....	<b>7</b>	Adjusting the sound .....	33
Scope of delivery .....	7	Adjusting the picture.....	35
About this operating manual .....	7	Button functions .....	37
<b>For your safety</b> .....	<b>8</b>	Operation without remote control.....	38
<b>Control unit front side of the device</b> .....	<b>10</b>	Status display.....	39
<b>Connections rear side of the device</b> .....	<b>11</b>	<b>Managing stations</b> .....	<b>41</b>
<b>Operating convenience</b> .....	<b>12</b>	TV stations.....	41
General information on menu operation .....	12	Put together / change favourites lists .....	44
Operating convenience with wizards .....	13	<b>Electronic Programme Guide</b> .....	<b>45</b>
Overview of wizards.....	13	Electronic Programme Guide – EPG .....	45
MediaPortal.....	14	Configuring EPG.....	46
The index in the TV set.....	15	<b>Teletext</b> .....	<b>47</b>
The info display .....	15	<b>Digital radio</b> .....	<b>48</b>
TV menu – Overview diagram.....	16	Radio mode (DVB radio).....	48
Radio menu – Overview diagram.....	17	EPG – Electronic Programme Guide (radio) .....	49
Other menus – Overview diagram .....	17	Radio mode (Internet radio) .....	50
<b>Initial installation</b> .....	<b>18</b>	Audio playback from external devices.....	51
Installing the TV set .....	18	<b>Other settings</b> .....	<b>52</b>
Set covers .....	18	Parental lock.....	52
Connecting the TV set.....	18	Timer functions .....	53
Preparing the remote control unit.....	20	Language .....	53
Turning the set on/off.....	21	On-screen displays .....	54
First installation wizard .....	22	Time and date .....	54
Positioning/aligning DVB-T antenna .....	30	<b>Coded stations</b> .....	<b>55</b>
		Conditional Access module (CA module).....	55

# Contents

<b>Media+</b> .....	<b>56</b>	<b>Software update</b> .....	<b>96</b>
General information on Media+ .....	56	Basic information .....	96
Connecting the TV set to your network .....	56	USB stick .....	96
Internet radio .....	56	Software update via USB .....	96
Help for configuration problems .....	56	Software update via internet .....	97
MediaUpdate - additional functions .....	56	<b>Input of characters</b> .....	<b>98</b>
Accessing your media .....	57	Character table .....	98
Media menu .....	57	<b>Troubleshooting</b> .....	<b>99</b>
MediaHome .....	61	<b>Technical data</b> .....	<b>101</b>
MediaMusic .....	64	General data .....	101
MediaPhoto .....	65	Electrical data .....	102
MediaVideo .....	66	Signals via PC IN / HDMI .....	102
<b>Interactive data services</b> .....	<b>68</b>	Connections (max. equipment) .....	103
HbbTV / MediaText .....	68	MediaHome .....	104
<b>Digital Recorder</b> .....	<b>69</b>	<b>Accessories</b> .....	<b>105</b>
About the Digital Recorder system .....	69	Equipment variants .....	106
Settings .....	72	TV set equipment .....	106
Archive recording – Direct recording .....	73	Setup possibilities .....	107
Archive recording – Timer recording .....	75	<b>Environment</b> .....	<b>108</b>
Timer list .....	77	<b>Legal notes</b> .....	<b>109</b>
TV viewing with time shift .....	78	<b>Glossary</b> .....	<b>110</b>
Archive playback .....	80	<b>EC Declaration of Conformity</b> .....	<b>115</b>
DR+ Streaming .....	83	<b>Index</b> .....	<b>117</b>
<b>External devices</b> .....	<b>86</b>	<b>Service</b> .....	<b>119</b>
Connections menu .....	86		
Devices to the connections AV/AV-VIDEO .....	87		
Devices to the HDMI connections .....	89		
Devices to the PC IN connection .....	90		
Sound components wizard .....	91		
Adjusting the speaker system .....	92		
Connecting HiFi/AV amplifiers .....	94		
Operating Loewe equipment .....	95		

# Welcome

## Thank you

for choosing a Loewe TV set!

Loewe stands for the highest demands in technology, design and user friendliness. This applies equally for TV, video and accessories.

In addition to the elegant design and the many different possible colour combinations and installation possibilities, your Loewe TV set also offers many technological options.

## Loewe Image enhancement

State-of-the-art Full-HD-LCD-displays with LED-Backlight Technology. The advantage of the LED-Backlight is in the reduced energy consumption and high contrast values.

24p films played by a connected HDMI unit can be displayed optimally.

## Loewe Media+

You can reach the MediaPortal via the MEDIA button on your remote control, giving you access to all multimedia functions of your TV set.

## Loewe Digital+

With Loewe Digital+ you're all set for all types of reception - doesn't matter whether it's DVB-T, DVB-C or DVB-S in SD and HD quality.

The integrated CI Plus interface even enables you to receive Pay TV<sup>(1)</sup>.

## DivX videos

The software of your TV set supports the video codec DivX including DivX Home Theater (HT) profil. In addition, there is also the option of calling up content from DivX VoD (Video On Demand) (registration with DivX required). For registration details see pages 57 and 60.

## Scope of delivery

- LCD TV set
- Mains cable
- Remote control Assist with two batteries
- TV quick guide

## About this operating manual

For best results regarding safety and the longevity of the set, we recommend you read the chapter **For your safety** (page 8) before switching it on for the first time.

The functions of the Loewe TV set are largely self-explanatory. However, should you have any questions, the integrated **index** and the **info display** (see page 15) can assist you further.

The index/glossary from page 110 onwards gives explanations of certain terms used in the TV set and the operating manual.

Paragraphs which begin with the symbol **■** indicate important instructions, tips or conditions for the following settings.

Terms which you will find in the menus or printed on the remote control or TV set are written in **bold** type.

The necessary control elements are shown in the descriptions to the left of the text containing the instructions for action.

Depending on the connected accessory equipment the menus in the TV set can differ from those described here.

All the station names, programme contents, the illustrated photos, titles, albums and album covers in this operating manual are examples.

The operating instructions for your TV set are updated at irregular intervals. We recommend checking now and then, especially after a software update.

<sup>(1)</sup> If you wish to view encrypted channels then you will require a decoding module (CA module); these are easily available in specialist stores.

# For your safety

Please read and observe the following safety instructions both for your own safety and to prevent your TV set from unnecessary damage:

## Proper use and environmental conditions

This TV set is designed exclusively for reception and reproduction of video and audio signals and is designed for living rooms or office facilities, and should not be operated in rooms with high **humidity**, such as a bathroom, or sauna, or where there is a high **concentration of dust** (e.g. workshops). The manufacturer's warranty is only valid for use in the specified permissible environment.

If the set is used outdoors ensure that it is protected against **moisture** (rain, splashing water, or dew). High humidity and dust concentrations cause leak currents in the device, which can cause a shock hazard if the device is touched, or a fire.

If you have brought the set into a warm environment from the **cold**, then wait for about 1 hour before switching it on to avoid formation of **condensation**.

Do not place any **objects** filled with **liquids** on top of the appliance. Protect the appliance against dripping and splashing water.

**Candles** or **naked flames** must be kept away from the appliance at all times to prevent it from catching fire.

Never place the TV set in a position where it is exposed to **vibrations**. This can lead to material overload.

## Transporting

Only transport the device in **vertical position**. Grasp the device on the upper and lower edges of the housing. If the table stand is not installed (e.g. if the unit is to be installed on a wall), then under no circumstances should you set down the TV set on the protruding control unit on the underside. If the set has to be put down during packing/unpacking, place the TV set with the entire front surface lying flat on a soft underlay such as a blanket or the felt from the packing material.

The LCD screen is made of glass or plastic and can break if not handled properly.

Always wear rubber gloves to carry the TV set if the LCD screen is damaged and **liquid crystal** might be leaking out. In the case of **skin contact** immediately wash thoroughly with water.

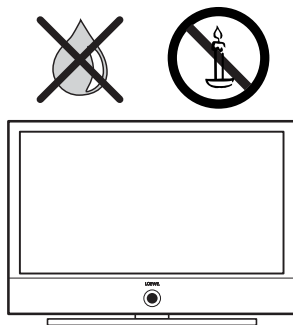

## Power supply

The **wrong voltage** can damage the set. This equipment must only be connected to a mains power supply which has the same voltage and frequency as that specified on the rating plate; use the mains cable provided. The **mains plug** of the TV set must be easily accessible so that the device can be disconnected from the mains at any time. When you unplug the mains plug, do not pull on the **cable** rather pull on the plug housing. The cable in the mains plug could be damaged and cause a **short circuit** the next time it is plugged in.

Lay out the **mains cable** in such a manner that it cannot be damaged. The mains cable must not be kinked or laid over sharp edges, stepped on or exposed to **chemicals**; The latter also applies for the entire equipment. A mains cable with damaged insulation can cause **electrical shock** and is a **fire hazard**.

## Air circulation and high temperatures

The **vent slots** on the **rear panel** of the set must always be kept free. Please do not place newspapers or cloths on/over the TV.

Ensure that there is at least 10 cm free space on the sides and above the set for air circulation, if the set is placed in a **cabinet** or on a **shelf**.

Like any electronic device, your TV set requires **air for cooling**. Obstruction of the air circulation can cause fires.

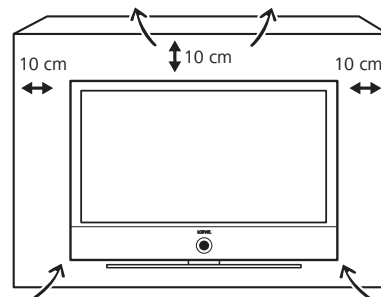

Prevent **metal items**, needles, paper clips, liquids, wax, or similar items, from getting into the interior of the device through the **vent slots** in the rear panel. Such objects can cause **short circuits** in the set, which could possibly cause a fire.

If something should get into the **interior of the set** then immediately unplug the mains plug of the device and contact **customer service** for more information.

## Automatic shutdown (only in Home Mode)

If the TV is not operated for 4 hours (adjustment of volume, programme change, etc.) the TV will automatically switch to stand-by mode to save energy. A prompt to terminate this shutdown process appears one minute before expiry of the 4 hours. The automatic shutdown is only active in the energy efficiency mode **Home Mode**.

Automatic shutdown does **not** occur when using the radio **without** screen display (**screen off**).



# For your safety

## Installation

The set is suitable for different installation solutions. See the instructions for assembly for the different installation solutions.

Stand the TV set with the table or floor stand only on a level, **sturdy, horizontal base**. Particularly ensure that the set does not protrude to the front when placed in or on pieces of furniture.

Place the TV set in a normal position for use. The TV set may only be used in an upright horizontal position. It may not be tilted by more than 10 degrees. The TV set must never be operated vertically, lying flat or hanging overhead from the ceiling.

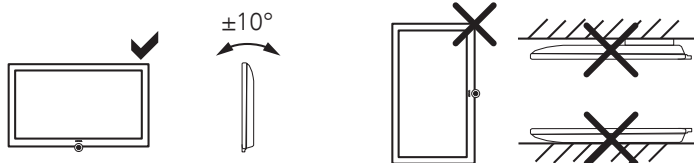

Set up the device where it is not exposed to direct **sunlight** and where it is not exposed to additional warming through **heating elements**.

## Repairs and accessories

Never remove the back of the TV set yourself. Only have your TV device repaired or serviced by **authorised television technicians**.

Only use **original accessories** such as Loewe stands if possible (see Accessories on pages 105 and 107).

## Supervision

Do not allow **children** to use the TV set without supervision or to play in the immediate vicinity of the TV set. The set could tip over, be pushed off or pulled down from the stand surface and injure someone.

Do **not** allow the switched-on TV set to run **unattended**.

## Volume

Loud music can lead to ear damage. Avoid extreme volume especially over long periods and when using headphones.

## Thunder storms

Pull out the **mains plug** and all connected **antenna cables** from the TV set in a thunderstorm. Overvoltage caused by **lightning** can damage the set via the antenna system, as well as via the mains. The mains plug and all connected antenna cables should also be pulled out during long periods of **absence**.

## Note on the LCD screen

The TV set you have purchased with LCD screen satisfies the most rigorous quality requirements and has been inspected relative to **pixel errors**. Despite our thorough care when manufacturing the display, it cannot be 100% guaranteed that no **subpixel** defects will be present due to technical reasons. Please understand that these types of effects, as long as they are within the standard of specified limits, cannot be considered as a device defect in terms of the guarantee.

Avoid displaying **still images** for long periods of time. It is possible that a copy of the image may remain.

## Cleaning and care

Switch off the TV set at the main switch before cleaning.

Clean the TV set, the screen, and the remote control unit with a soft, moist, and clean cloth only, **without** any **aggressive** or **scouring cleaning agents**.

# Control unit front side of the device

english

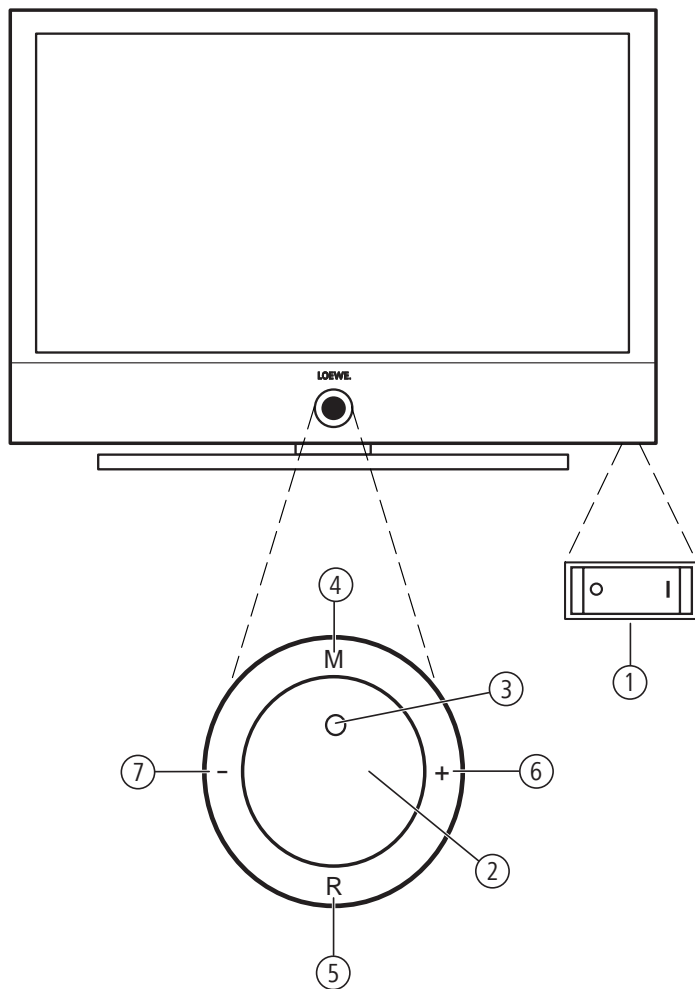

## Functions of the operating elements

- ① **Mains switch:**  
The mains switch is located on the bottom of the set.
- ② **On/Off button:**  
Switch on from the standby mode  
Switch off to the standby mode
- ③ **Display:**
  - red = Standby
  - green = Operation
  - orange = Operation without on-screen display (radio mode, archive recording with the digital recorder or software update).
- ④ **Button M:**  
Call the menu  
in the menu: up/down ▲ ▼
- ⑤ **Button R:**  
Radio on/off (back to TV mode)  
Switch on the radio from the standby mode  
in the menu: down ▼
- ⑥ **Button +:**  
Station up  
in the menu: to the right ►
- ⑦ **Button -:**  
Station down  
in the menu: to the left ◀

# Connections rear side of the device

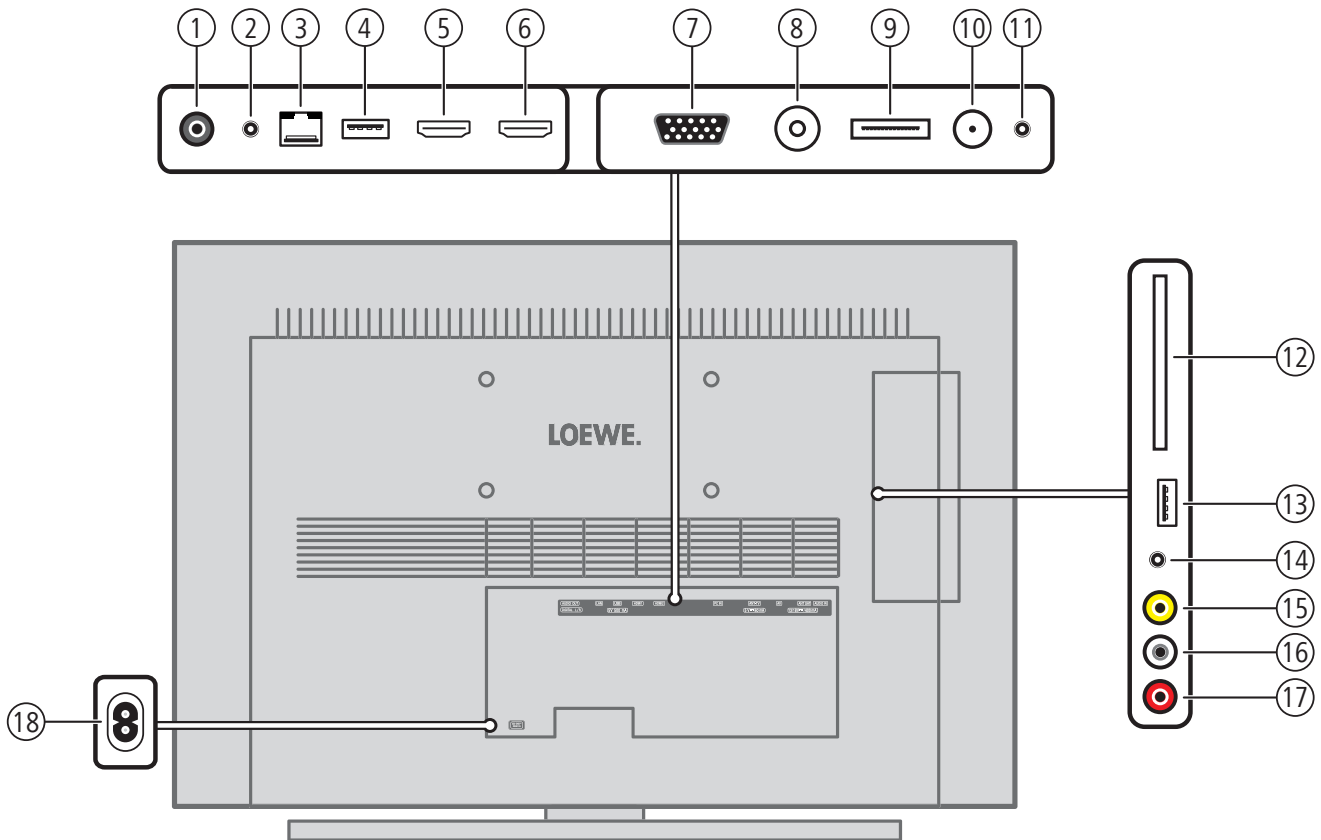

- ① **AUDIO OUT DIGITAL**- Audio output (digital)
- ② **AUDIO IN L/R** - Audio input (analogue)
- ③ **LAN** - Network connection
- ④ **USB** - USB connection
- ⑤ **HDMI 1** - HDMI input 1
- ⑥ **HDMI 2** - HDMI input 2
- ⑦ **PC IN** - VGA/XGA input
- ⑧ **ANT-TV** - Cable analogue / Antenna/cable digital
- ⑨ **AV** - Mini Scart socket <sup>(1)</sup>

- ⑩ **ANT SAT** - Satellite antenna (Sat tuner) digital
- ⑪ **AUDIO OUT L/R** - Audio output left/right (analogue)
- ⑫ **COMMON INTERFACE** - Common Interface (CI slot)
- ⑬ **USB** - USB connection
- ⑭ **🎧** - Headphones connection
- ⑮ **VIDEO** - Video in (AV-VIDEO)
- ⑯ **AUDIO - L** - Audio in left (AV-VIDEO)
- ⑰ **R - AUDIO** - Audio in right (AV-VIDEO)
- ⑱ **220-240V~ 50/60Hz** – Mains connection

<sup>(1)</sup> Scart adapter is available as an accessory.

# Operating convenience

## General information on menu operation

The operation can be divided basically into two areas: The operation of dropdown lists (e.g. station list, favourites list, EPG etc.) and the menu operation (TV menu etc.) for configuring your TV set.

- ➔ If any questions arise during the operation of your TV set, an appropriate info screen can be accessed to help you by pressing the **INFO** button (see also info display on page 15).

### Selection list (example: Station list)



- ▲ ▼ ◀ ▶ You move the cursor by pressing the ring (up, down, left, right).



- P+ / P-** If more selection options are available than will fit on one screen **page ↓** is displayed. You can scroll the pages with **P+ / P-**.



- OK** The **OK** button calls the selection or confirms the setting.



- With the coloured buttons you can select different options depending on the application. The assignment of the coloured keys is shown at the bottom of the screen.



- INFO:** Additional information about the screen page.



- END:** Close/exit dropdown list.

### Inputs with the numeric buttons



Letters have to be entered for specific functions. When using the remote control, press the numeric buttons just as on a mobile phone keypad (0-9) until the desired symbol is displayed. The available letters are printed on the individual numeric buttons.

See page 98 for a detailed overview of the available characters.

### Menu operation (example: TV menu)

Menus for the individual modes (TV, Radio, EPG, Teletext, MediaPortal and archive<sup>1)</sup>) are called with the **MENU** button.

The menus are displayed at the bottom of the screen. At the top you get additional information about the selected menu item (see info display on page 15).

- ➔ In normal TV mode, without other displays.



**MENU:** Call TV menu.

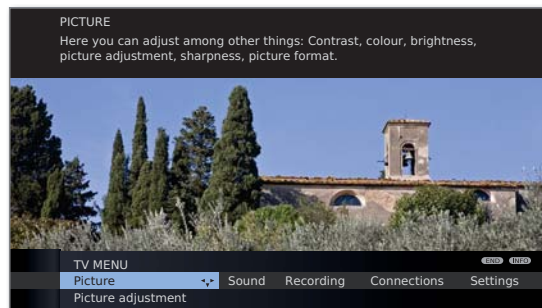

- ◀ ▶ Select **Picture**,  
▼ go to the menu line below.
- ◀ ▶ Select **Brightness**,  
▼ go to the menu line below.
- ◀ ▶ Set **Brightness**.  
▲ Return to the **Brightness** menu line to make other picture settings.
- ◀ ▶ Select **more ...**,  
**OK** call **more ...** functions.
- ◀ ▶ Select **Auto format**,  
▼ go to the menu line below.
- ◀ ▶ Select **on / off**.



**END:** Conclude the settings.

### Menu structure

You can find a diagram of the menu structure in the overview diagrams, page 16 and after.

<sup>1)</sup> Only if a USB storage device is connected.

# Operating convenience

## Operating convenience with wizards

For many settings your TV set has user guidance with wizards which guide you through the settings step by step.

## Overview of wizards

### Initial installation

The initial installation wizard will help you both to install your TV set for the first time and to connect any additional devices that you may have (see page 22).

### Setting up the antenna

You enter in the antenna wizard which antenna signals are available to you. The antenna wizard will be loaded for the first time during initial installation (see page 22). You can also call the antenna wizard in the **TV menu** under **Connections** → **Antenna DVB** → **Antenna DVB-S** or **Antenna DVB-T**.

### Search wizard

If you want to search for new stations after the initial installation, or if you have set up your antenna for the first time, then you can handle this task with the help of the search wizard (see page 41). You will find the search wizard in the **TV menu** under **Settings** → **Stations** → **Search wizard**.

### Connecting sound components

The sound component wizard ensures that the components which reproduce the TV sound are correctly registered, connected and set. It is started automatically at the end of the initial installation wizard but can also be called separately (see page 91). You will find the sound components wizard in the **TV menu** under **Connections** → **Sound components**.

### Programming and managing recordings

The recording wizard helps you when programming a recording with the digital recorder <sup>(1)</sup> (see page 75 onwards).

### Software update

You can download the latest software for your TV set from the Loewe Service site and update using a USB stick (see page 97).

<sup>(1)</sup> Only if a USB storage device is connected.

# Operating convenience

## MediaPortal

The MediaPortal is the central overview page for your TV set's functions. From here you can gain access to TV channels, local and online media, digital radio and to the archive of the digital recorder<sup>(1)</sup>.

### Call MediaPortal

MEDIA

**MEDIA:** Call **MediaPortal**.

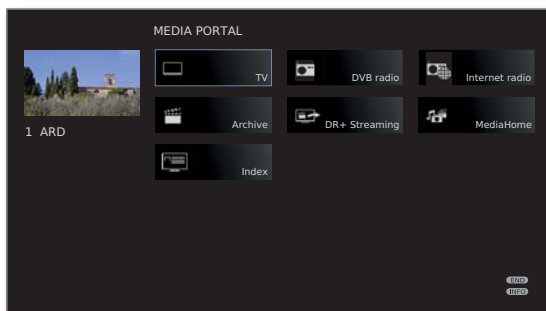

The individual media and various functions are organised in the MediaPortal.

The number of selectable items varies depending on the TV equipment, network connection, available media/media servers and connected appliances.



◀ ▶ ▲ ▼ Select menu item,  
**OK** call.

### Description of the individual functions:

- TV:** Here you call the TV mode of your TV set. See page 31 for further information.
- DVB radio:** Use this to open the DVB radio mode of your TV set to listen to digital radio stations over DVB. See page 48 for further information.
- Internet radio:** Use this to open the Internet radio mode of your TV set to listen to digital radio stations over the Internet. The menu item only appears if an Internet connection is available. See page 50 for further information.
- Archive<sup>(1)</sup>:** With the **archive** you have access to all the recorded programmes contained on any USB storage devices that are connected. See page 69 for further information.
- DR+ Streaming:** **DR+ Streaming** gives you access to programmes provided by a TV set with integrated hard disc (DR+) in your home network (chassis SL1xx with software version 7.9.0 and higher). See page 83 for further information.
- MediaHome:** Here you have access to your personal storage devices, e.g. to all storage devices connected via USB or to networks with which your TV set is connected. See page 61 for further information.
- Index:** Here you have access to the index integrated in the TV set. See page 15 for further information.

<sup>(1)</sup> Only if a USB storage device is connected.

# Operating convenience

## The index in the TV set

The index explains the TV functions and the terms that you may be confronted with when operating the TV set. You can start all the assistants and many of the operating functions directly from here.

Alphabetic sorting is preceded by the items **Menu language**, **Energy efficiency**, **Integrated features** and **Repeat initial installation**.

### Call index

MEDIA

**MEDIA:** Call **MediaPortal**.



◀ ▶ ▲ ▼ Select **Index**,  
**OK** call.

You will see an info text for the highlighted keyword in the info display.

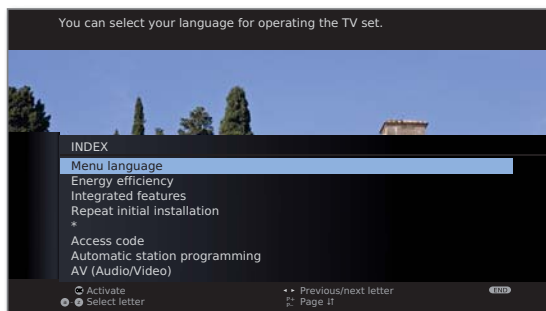

If an OK symbol appears in the marked line, this function can be called directly with **OK**.

### Selecting a keyword



Enter initial letters with the **numeric buttons** like with a mobile phone keypad (see page 12).

or go with



◀ ▶ to the preceding / next letters,  
▼ ▲ from line to line.



**P+ / P-** Flip forwards or backwards through the pages.

Example: You want to have the TV set switch off automatically at a specific time:

Select the keyword **Switch off** → **Automatic**, with **OK** you can activate the setting.

## The info display

The info display provides an info text appropriate to the on-screen display that can assist you further with the operation of your TV set. Together with the index it makes for a comfortable operating system.

➡ An on-screen display is faded in.

INFO

The factory setting is that the info display is shown automatically for each menu item. In this case you can temporarily hide the info texts with the **INFO** button.

The info display can be constantly switched off via the **TV menu** → **Settings** → **Miscellaneous** → **On-screen displays** → **Automatic info** → **no**.

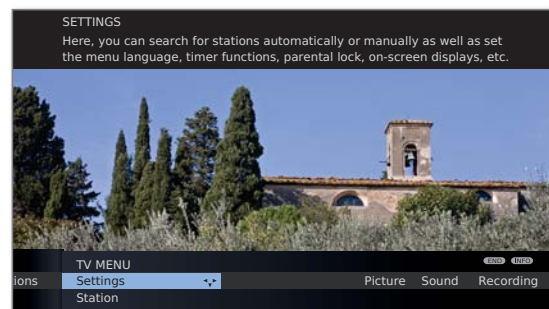

You will also be able to see that there is an info-text available from the displayed **INFO** symbol at the bottom right.



If an info text over several pages is available the number of available pages and **P+P- Page 11** is displayed in the Info window. You can scroll through the individual info pages with **P+** and **P-**.

### Permanently display or hide the automatic info display

Once you have become familiar with how to operate the TV set, you can switch off the automatic info display.

➡ In normal TV mode, without other displays.

MENU



**MENU:** Call **TV menu**.

- ◀ ▶ Select **Settings**,  
▼ go to the menu line below.
- ◀ ▶ Select **Miscellaneous**,  
▼ go to the menu line below.
- ◀ ▶ Select **On-screen displays**,  
▼ go to the menu line below.
- ◀ ▶ Select **Automatic info**,  
▼ go to the menu line below: **yes / no**.

# Operating convenience

## TV menu – Overview diagram

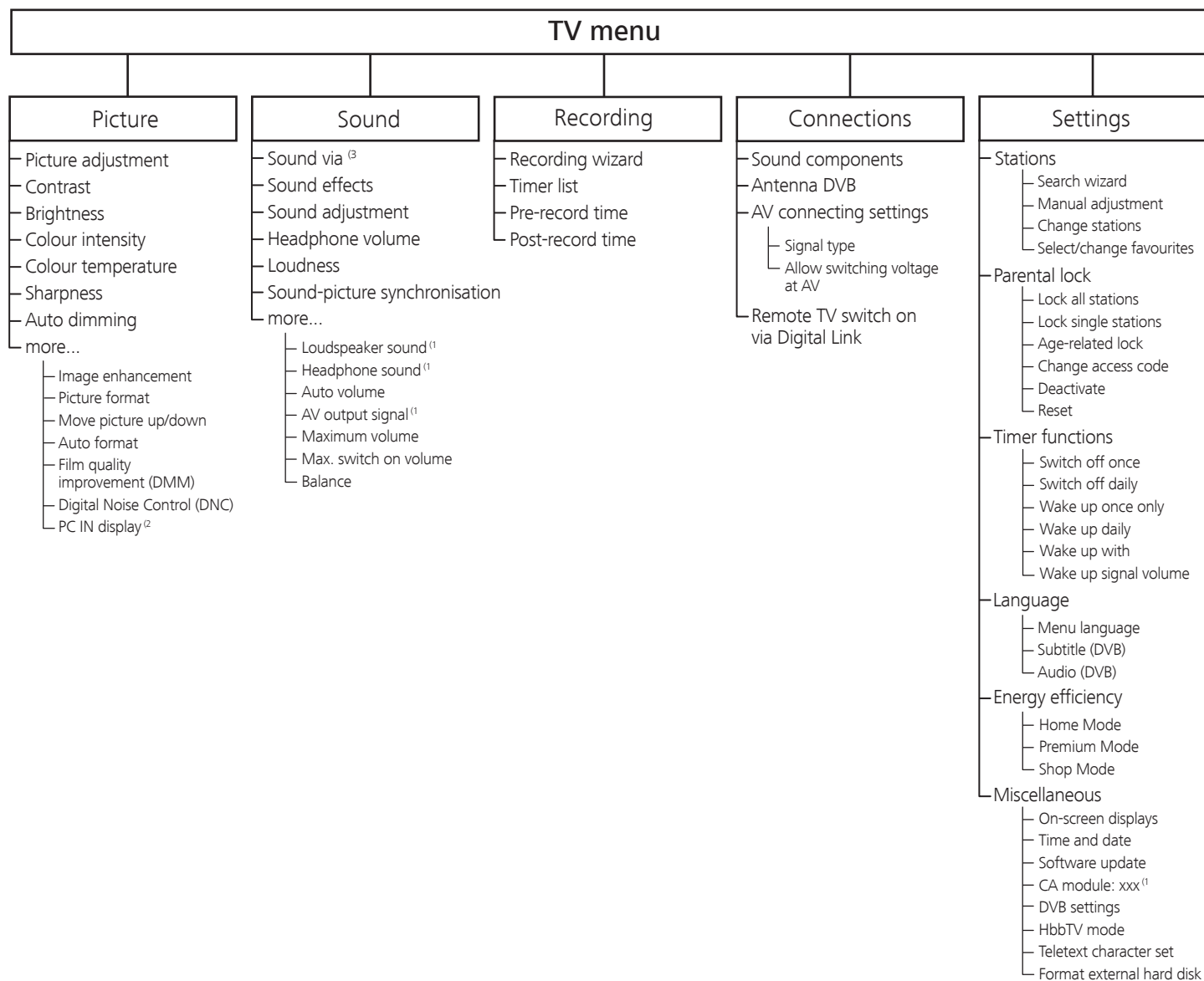

<sup>1</sup> Menu items appear depending on the signal source currently selected (DVB or analogue) and/or at definite presettings in the relevant menus.

<sup>2</sup> Menu item can only be selected if a valid signal is present at the **PC IN** input.

<sup>3</sup> The menu item will appear only when sound is being reproduced via **HiFi/AV amplifier or TV speakers (switchable)**.



# Operating convenience

## Radio menu – Overview diagram

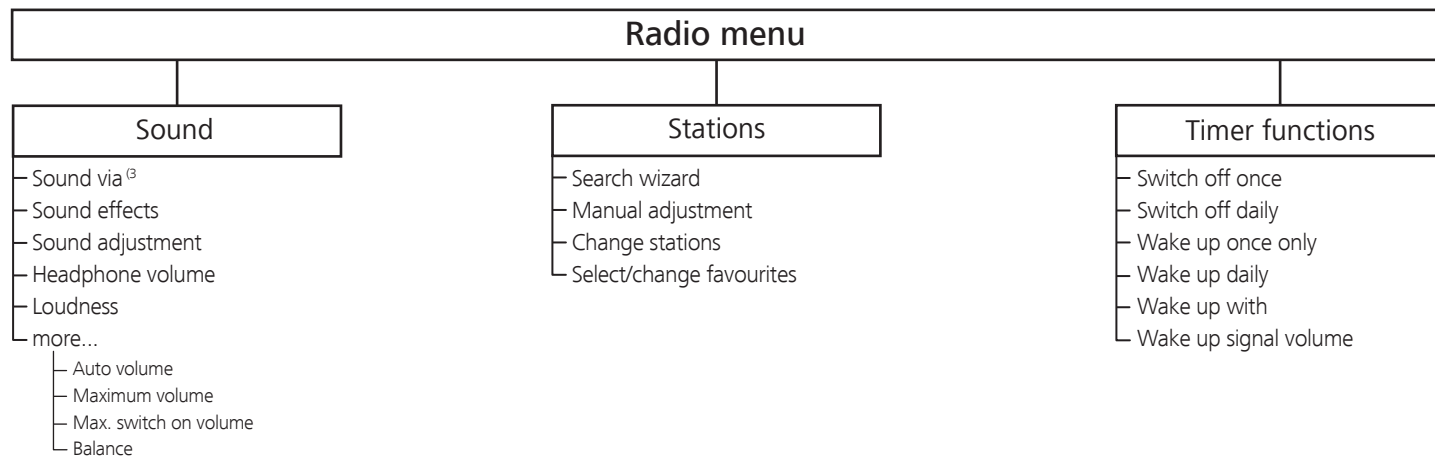

## Other menus – Overview diagram

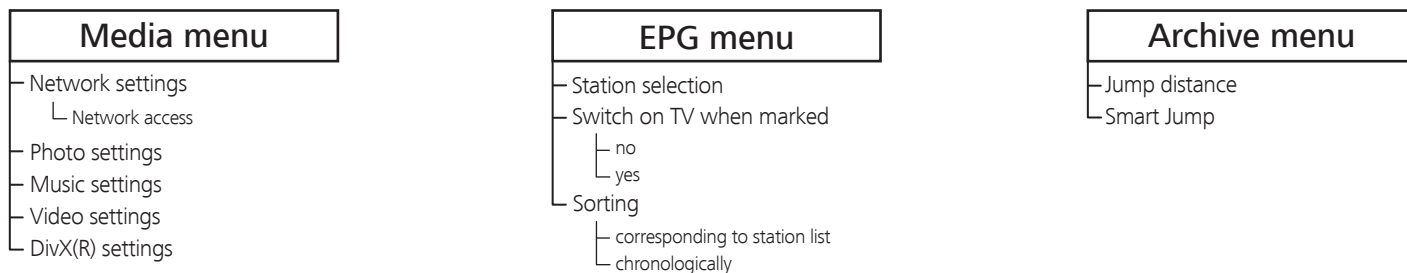

# Initial installation

## Installing the TV set

### Installation options

Your TV set is supplied equipped with a table stand. You are given the option of choosing another installation solution tailored to your requirements from your Loewe dealer. Only use Loewe installation solutions (e.g. wall mounts, floor stand) that are included in the Accessories – Setup possibilities chapter on page 107.

After selecting an installation option, read the appropriate assembly instructions.

### Installation notes

Choose a place for installing your TV where no bright light or sunlight shines directly onto the screen. This could cause reflections which impair the picture.

3 times the screen diagonal can be taken as a guide value or the viewing distance (e.g. for 40-inch set approx. 3m for SD signal). The viewing distance can be reduced with an HD signal.

## Set covers

### Covers for side connections

The side cover of the TV set can be completely removed. For this, open it as far as it will go and gently pull on the open cover.

The cover detaches from the holder and gives free access to the connection area. To replace the cover, simply push it until it latches back into place.

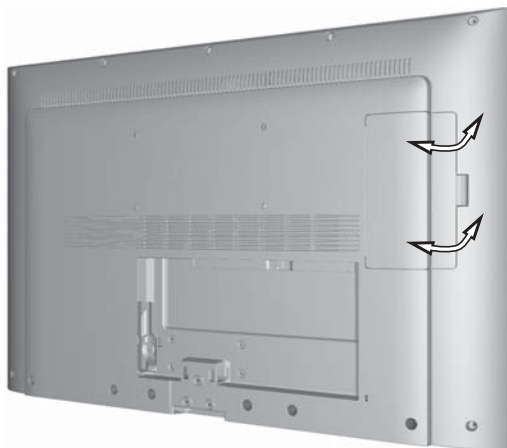

## Connecting the TV set

### Connecting to the mains

Remove the cover for the connections.

Connect the TV set to a 220-240V mains socket:

First plug the small plug of the power cable into the mains connection on the back of the TV and then plug the large mains plug into a mains socket.

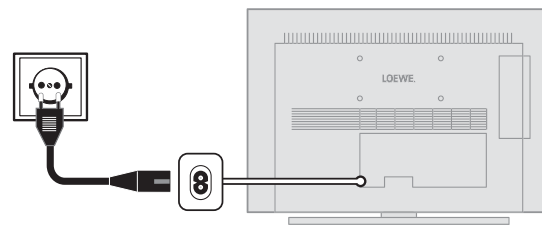

### Connecting antennas

Cable (analogue) / DVB-C / DVB-T antenna:

Plug the antenna cable of antenna, cable system or room antenna into the **ANT TV** socket.

If you want to use analogue cables / DVB-C connection and a DVB-T antenna together, use an external antenna switch (available from your dealer).

Satellite antenna DVB-S:

Depending on the used satellite system, connect a connecting cable from the multi-switch or directly from the LNC to the **ANT-SAT** socket of the TV.

When connecting the TV set to a single cable community antenna, connect the **ANT-SAT** socket directly to the appropriate SAT antenna socket. Ask your dealer if required.

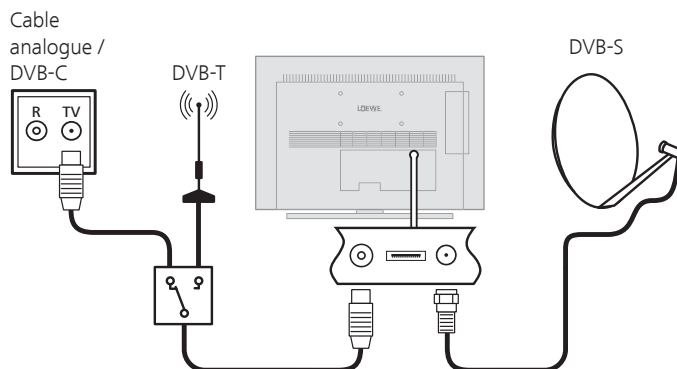

# Initial installation

## Connecting the TV set to the home network

You can connect your TV set to the home network by a **wired connection** (Ethernet, Powerline) or by a **wireless radio connection** (WLAN). Please contact your specialist dealer for more information on Powerline.

For the network adapter configuration, see page 58.

### Example for a wired connection

Connect the LAN socket of your TV set to the LAN switch/router of your home network with a network cable (available from your dealer).

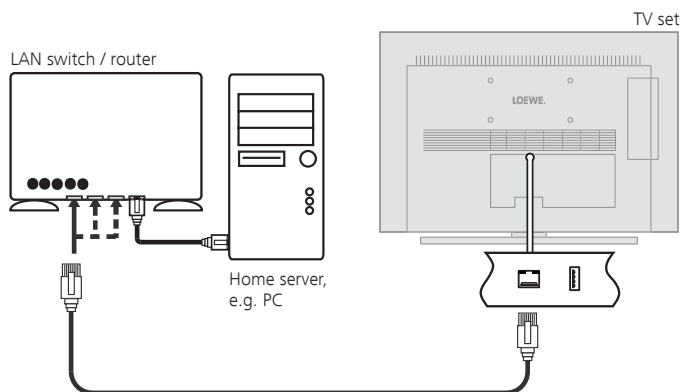

### Example for a wireless connection

You can connect the TV set to your home network via wireless radio connection by using the WLAN USB stick that is available as an accessory.

The alignment of the WLAN USB stick can be optimised for the best possible reception using the USB extension available as an accessory (see page 105)

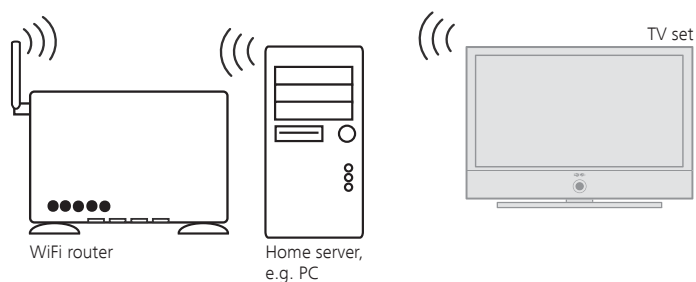

# Initial installation

## Preparing the remote control unit

### Inserting or replacing batteries

Press on the embossed arrow whilst pushing the battery cover down.

Only use leak-proof micro-cells of the LR 03 (AAA) Alkali-Manganese type. Do not use different types of batteries and old and new batteries together.

The batteries used must not be exposed to excessive heat such as sunlight, fire or similar!

Pay attention to the correct polarity of + and – when inserting the batteries.

If the batteries are too weak after longer use, the TV set prompts you to change the batteries.

Dispose of used batteries in an environmentally friendly way (see page 108).

Push the cover back on from below after inserting the batteries.



### Adjusting the remote control for operating the TV set

TV

Press the **TV button**.

See page 95 for how to operate other Loewe appliances and how to reprogramme the remote control buttons.

# Initial installation

## Turning the set on/off

### Switching the TV set to standby mode

Press the mains switch on the bottom right of the set (I position).  
The display in the control panel on the front lights up first orange and then red. The set is now in standby mode.

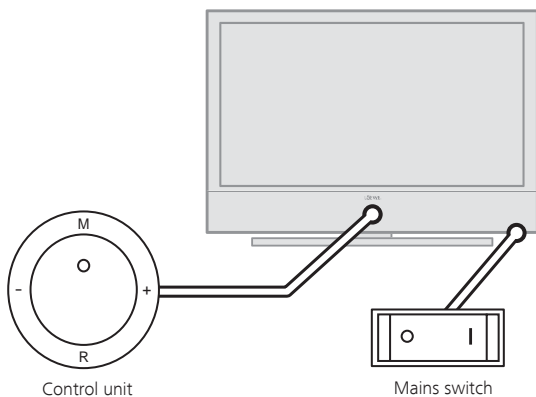

### Switching the TV on/off on the control unit

To switch the TV set into operating mode or switch it off into standby mode, press the middle of the on/off button for about 2 seconds.

Meaning of the display colour of the LEDs in the on/off button:

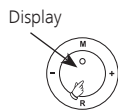

**Red:** Standby mode

**Green:** TV set is switched on

**Orange:** Radio mode or archive recording with the Digital Recorder is active <sup>(1)</sup>.

### Switching the set on with the remote control



Press the **on/off button**



or  
**numeric buttons**



or  
**TV button**



or  
**OK button** – station list is called



or  
**MEDIA button** – MediaPortal is called.

### Switching the set off with the remote control



Press the **on/off button**.

➡ Before switching off the set with the mains switch, we recommend you to switch it to standby mode.

### Switch on in Radio mode



Press **R** on the TV control unit.



OR:  
Press the **AUDIO button** on the remote control (radio mode, see page 48).

### Switch off TV set using the mains switch

Press the mains switch on the bottom of the set (O position).  
The TV set is now completely switched off.

➡ When switching off the TV set with the mains switch, the status display remains lit in the operating eye for about 20 seconds.

<sup>(1)</sup> Only if a USB storage device is connected.

# Initial installation

## First installation wizard

### Initial installation after switching on for the first time

This wizard starts automatically after the set is switched on for the first time, however it can also be called later manually in the TV index, see **Repeat initial installation** on page 15.

- ➡ If at least one station is locked the access code must be entered before repeating initial installation (see Parental lock on page 52).

### First installation wizard routine

The routine of the first installation wizard depend on the selected settings.

Language

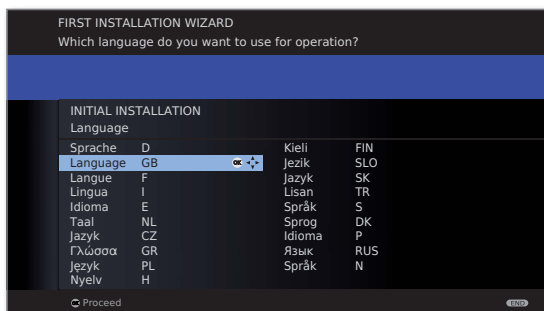

▲ ▼ ◀ ▶ Select language.

Selecting the language of the user guidance is the wizard's first step. Then you simply follow the instructions on your TV screen.

**OK Proceed.**

Energy efficiency

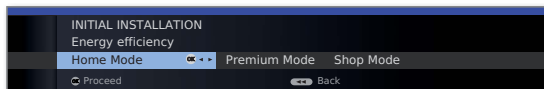

◀ ▶ Select Energy efficiency.

Decide how energy efficiently you want to operate your TV set. The value for the contrast (and thus the brightness of the background lighting) is adapted and the automatic dimmer activated or deactivated (see page 35) depending on the presetting.

Energy efficiency (continued)

### Home Mode:

The emphasis for home use is on low energy consumption. The automatic dimmer is activated.

### Premium Mode:

This mode optimises the settings to a brighter environment at a higher energy consumption. The automatic dimmer is activated.

### Shop Mode:

The picture settings are aligned to operation in the presentation room. The automatic dimmer is deactivated. If the ambient brightness diminishes, the energy consumption is not reduced.

The presetting can be changed later in the **TV menu** under **Picture** → **Picture adjustment** (see page 35) or under **Settings** → **Energy efficiency**.

**OK proceed.**



Location of TV set

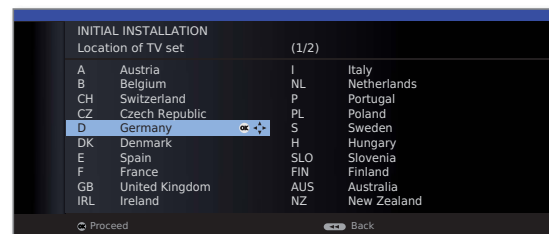

▲ ▼ ◀ ▶ Select **Location of TV set** (national defaults are adopted).

**OK Proceed.**

Selecting antennas

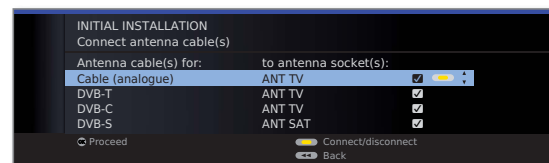

▲ ▼ Select antenna cable.



**Yellow button: Connect/disconnect antenna cable.**

**Cable (analogue):**

**DVB-T:**

**DVB-C:**

**DVB-S:**

analogue stations via cable  
digital terrestrial stations  
digital stations via cable  
digital stations via satellite

continued on next page →

# Initial installation

Selecting antennas (continued) Depending on which antenna(s) was (were) selected, the appropriate settings are called later during the routine.



**OK proceed.**

Subtitle and audio languages (DVB)

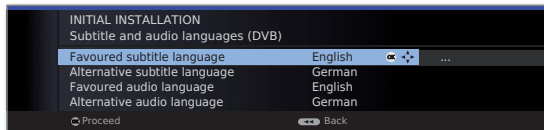

▲ ▼ ◀ ▶ Select desired languages and alternative languages for subtitles and audio for DVB programmes (see page 53).

**OK Proceed.**

## Setting options for DVB-T reception:

If you have not selected a DVB-T antenna in the antenna selection: Continue with **setting options for DVB-C reception** on page 24.

Settings

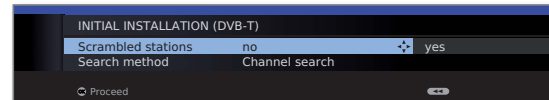

▲ ▼ ◀ ▶ Select and adapt settings for DVB-T reception.

Encrypted stations You can state whether coded stations are to be searched for in the search/update. Select **yes** to save all found scrambled stations. However, these stations can only be received in connection with a CA module and the appropriate Smart Card. Handling of the CA module is described on page 55.

If a CA module with a SmartCard is already plugged in for the station search, all the stations which this module can descramble are also saved when **no** is preset.

Search method If you want to run the station search independently of the channel grid, select **frequency search** for the search method.

**OK Proceed.**

Supply voltage

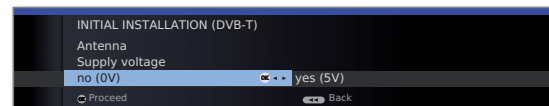

◀ ▶ Select supply voltage **no / yes**.

Use a DVB-T antenna that requires a supply voltage (active antenna) and which is not already supplied via a power adapter, then select **yes (5V)** for the antenna's power supply.

How to align your DVB-T antenna is described on page 30.

**OK Proceed.**

# Initial installation

## Setting options for DVB-C reception:

If you have not selected a DVB-C antenna in the antenna selection: Continue with **Setting options for DVB-S reception** (see right hand column).

The normal DVB-C settings are derived from the selection of the location and do not need to be changed.

### Settings

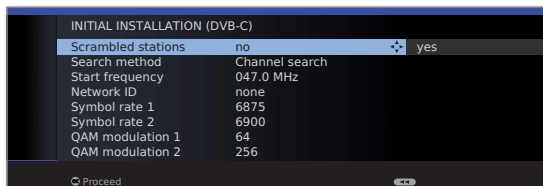

▲ ▼ ◀ ▶ Select and adapt settings for DVB-C reception.

### Encrypted stations

You can state whether coded stations are to be searched for in the search/update. Select **yes** to save all found scrambled stations. However, these stations can only be received in connection with a CA module and the appropriate Smart Card. Handling of the CA module is described on page 55.

If a CA module with a SmartCard is already plugged in for the station search, all the stations which this module can descramble are also saved when **no** is preset.

### Search method

If you want to run the station search independently of the channel grid, select **frequency search** for the search method.

### Start frequency

The DVB stations are only searched for in the frequency range above the start frequency.

### Network ID

Only change these defaults if you are familiar with other symbol rates and types of modulation or if you have to specify the network ID for your cable network. In the case of small cable networks fed directly from the satellite, the rate of 6900 might have to be replaced by 6111.

### Symbol rate

### QAM modulation

Your cable provider has the information you need.



**OK Proceed.**

## Setting options for DVB-S reception:

If you have not selected a DVB-S antenna in the antenna selection: Continue with **Setting options for all types of reception** on page 28.

The normal DVB-S settings are derived from the selection of the location and do not need to be changed in most cases.

### Select satellite installation

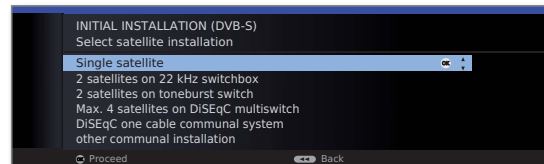

▲ ▼ Selecting the satellite system.

Specify how you receive which satellite(s) (single satellite or type of satellite system). Ask your dealer if required.

### Single satellite

Reception of a single satellite via a connected LNC (LNB). See page 25 for settings.

### 2 satellites on 22 kHz switchbox

Reception of two different satellites with two LNCs (LNBS) which are connected to the TV set by a 22 kHz switchbox. See page 25 for settings.

### 2 satellites on toneburst switch

Reception of two different satellites with two LNCs (LNBS) which are connected to the TV set by a toneburst switch. See page 25 for settings.

### Max. 4 satellites on DiSEqC multiswitch

The TV set controls a DiSEqC multiswitch to which up to four LNCs (LNBS) for different satellites are connected. See page 26 for settings.

### DiSEqC one cable communal system

Select setting if the TV set is connected to a DiSEqC single-cable system (according to EN 50494). Several Sat receivers can be connected to one Sat cable. See page 26 for settings.

### other communal installation

Select setting if the TV set is connected to a single-cable system (without DiSEqC). Several Sat receivers can be connected to one Sat cable. Unlike a DiSEqC single-cable system there are restrictions in the range of certain reception frequencies in single-cable community systems. See page 27 for settings.



**OK Proceed**

(to the appropriate page of the satellite system).



# Initial installation

## Setting options for the satellite system (single satellite):

Select single satellite



▲ ▼ Select satellite,  
**OK Proceed.**

High band

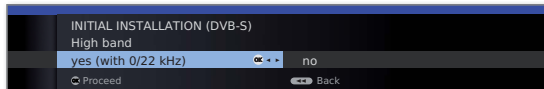

◀ ▶ High band **no / yes.**  
Specify here whether the high band of the selected satellite is to be searched in addition to the low band.

**OK Proceed.**

LNB frequencies

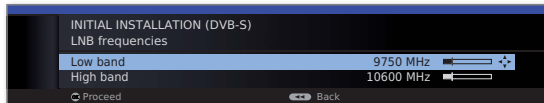

◀ ▶ Set LNB frequencies.  
Normally, you do not need to change the values for high and low band, unless the LNC (LNB) of your satellite system uses a different oscillator frequency (important for the frequency display).

**OK Proceed.**  
(with **Setting options for DVB-S reception (continued)** on page 28).

## Setting options for the satellite system (2 satellites on 22 kHz switchbox / 2 satellites on toneburst switch):

Satellite selection



▲ ▼ Select **Satellite 1 / Satellite 2,**  
▶ select satellites from list,  
**OK Proceed.**

LNB frequencies  
(22 kHz switchbox)

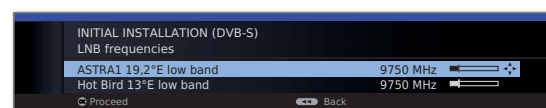

LNB frequencies  
(toneburst switch)

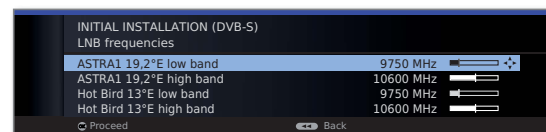

◀ ▶ Set LNB frequencies.  
Normally, you do not need to change the values for high and low band, unless the LNC (LNB) of your satellite system uses a different oscillator frequency (important for the frequency display).

**OK Proceed.**  
(with **Setting options for DVB-S reception (continued)** on page 28).

# Initial installation

## Setting options for the satellite system (max. 4 satellites on DiSEqC multiswitch):

Settings  
DiSEqC  
multiswitch

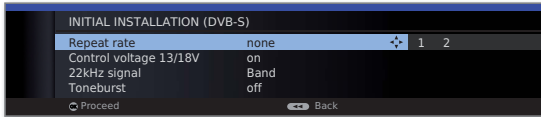

▲ ▼ ◀ ▶ Select and adapt settings for the DiSEqC multiswitch.

**Repeat rate** The refresh rate determines how often a DiSEqC command is output. A refresh is only necessary with cascaded systems.

**Control voltage** The control voltage controls the switching of the polarisation level (horizontal/vertical) in non-DiSEqC capable components (e.g. control of single LNBs via DiSEqC multiswitch).

**22kHz signal** The 22kHz signal controls the switching between high and low band in the **Band** setting. The **Position** setting controls the selection of the satellites in non-DiSEqC capable components.

**Toneburst** The Toneburst controls the selection of the satellites in non-DiSEqC but toneburst capable components with the **Position** and **Option** settings.

**OK Proceed**

Satellite  
selection

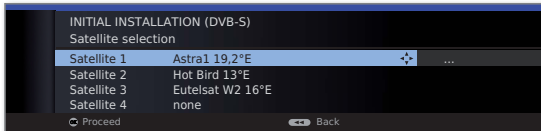

▲ ▼ Select **Satellite 1 ... Satellite 4**,  
▶ select satellites from list,  
**OK Proceed.**

LNB  
frequencies

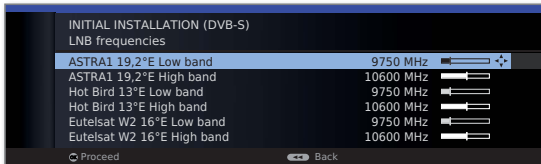

◀ ▶ Set LNB frequencies.  
You do not normally need to change the values.  
**OK Proceed.**  
(with **Setting options for DVB-S reception (continued)**  
on page 28).

## Setting options for the satellite system (DiSEqC one cable communal system):

Satellite  
selection



▶ Select satellites from list,  
**OK Proceed.**

LNB  
frequencies

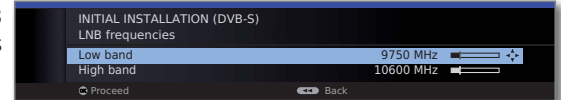

◀ ▶ Set LNB frequencies.  
Normally, you do not need to change the values for high and low band, unless the LNC (LNB) of your satellite system uses a different oscillator frequency (important for the frequency display).

**OK Proceed.**

Manual  
registration

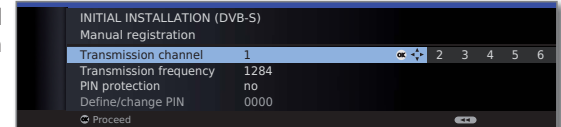

▲ ▼ ◀ ▶ Select and adjust settings for the DiSEqC single cable communal installation.

**Transmission channel/frequency** Select the desired transmission channel and the corresponding transmission frequency.

**PIN protection** If your system is designed for it, it is possible to protect your used transmission data from use by other subscribers with a PIN.



**OK Proceed.**  
(with **Setting options for DVB-S reception (continued)**  
on page 28).

# Initial installation

## Setting options for the satellite system (other communal installation):

Select single  
satellite



▲ ▼ Select satellite,  
**OK Proceed.**

LNB  
settings

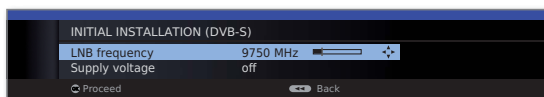

▲ ▼ ◀ ▶ Select and adapt settings.

LNC  
frequency

Normally, you do not need to change the values for high and low band, unless the LNC (LNB) of your satellite system uses a different oscillator frequency (important for the frequency display).

Supply voltage

If your set is connected to a single-cable system without external voltage supply, you can connect the antenna supply (13V or 18V / max. 450mA).



**OK Proceed.**

(with **Setting options for all types of reception** on page 28).

continued on next page →

# Initial installation

## Setting options for DVB-S reception (continued):

### Test reception

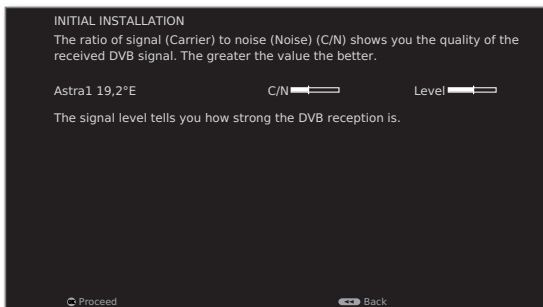

After you have made the previous settings, you should receive picture and sound of the selected satellites (only possible for Astra1 and HOTBIRD).

**OK Proceed.**



### Settings

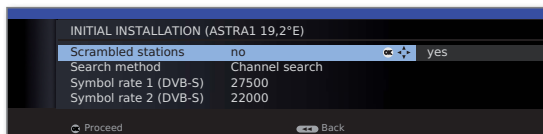

▲ ▼ ◀ ▶ Select and adapt settings.

If several satellites are received, the following settings must be made for every satellite. The scope of the settings may differ depending on the selected satellite.

### Encrypted stations

You can state whether coded stations are to be searched for in the search/update. Select **yes** to save all found scrambled stations. However, these stations can only be received in connection with a CA module and the appropriate Smart Card. Handling of the CA module is described on page 55.

If a CA module with a SmartCard is already plugged in for the station search, all the stations which this module can descramble are also saved when **no** is preset.

### Search method

If you want to run the station search independently of the channel grid, select **frequency search** for the search method.

### Symbol rates

The symbol rates are specified by the satellite provider and do not normally need to be changed.



**OK Proceed.**

## Setting options for all types of reception:

### Favoured signal source

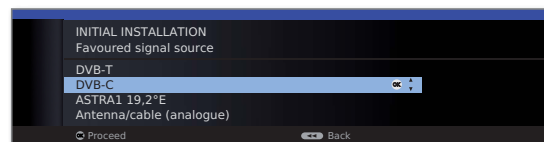

▲ ▼ Select favoured signal source.

Select the signal source from a list, the station of which is to be at the top of your station list (starting with station slot 1).

The listed signal sources depend on the selected antennas and, if the set is equipped with a satellite tuner, the type of satellite system used and the received satellites.

**OK Proceed.**

### Logical Channel Number



◀ ▶ Accept Logical Channel Number **no / yes**.

In some countries, digital channels (DVB-T, DVB-C, DVB-S) are transmitted with a prescribed programme number per channel; these are known as "Logical Channel Numbers" – "LCN".

If you select yes here, these prescribed channel slots will be used and the channels of the preferred signal source will be sorted as per LCN. Depending on the LCN, spaces or double channel allocations can occur in the numbering of the channel list.

**OK Proceed.**

# Initial installation

Overview of settings for station search

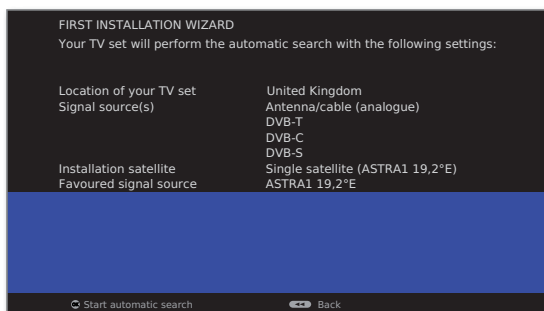

You will see a list of the selected settings. You can go back in steps with the ◀◀ button to make any changes to the settings.



## OK Start automatic search.

The set now searches for TV and radio stations.

The stations found in the automatic search are divided into the appropriate station blocks depending on the previously selected antenna cables (signal sources). Subsequently the stations can only be re-sorted within these blocks.

► At the beginning of the station list you will find the block with the stations of the preferred signal source. Any mixed sorting of stations from different signal sources is only possible with the favourites list (see page 44).

Info  
TV stations



Structure TV station list

FIRST INSTALLATION WIZARD  
The automatic TV station search and sorting has ended.  
966 new TV station(s) has (have) been found.

The number of found TV stations is displayed.

OK Proceed.

FIRST INSTALLATION WIZARD: STRUCTURE OF TV STATION LIST  
The TV stations found in the automatic search were divided into appropriate station blocks according to the previously selected antenna cables (signal sources). The stations can only be reorganised later within these blocks. The block with the stations of your favoured signal source is at the top of the station list.

Signal source	Associated station numbers
ASTRA1 19,2°E	1- 900
DVB-C	901-1300
DVB-T	1301-1400
Antenna/cable (analogue)	1401-1500

The structure of the TV station list is displayed.

OK Proceed.

Info  
radio stations



Structure radio station list

FIRST INSTALLATION WIZARD  
The automatic radio station search and sorting has ended.  
336 new radio station(s) has (have) been found.

The number of found radio stations is displayed.

OK Proceed.

FIRST INSTALLATION WIZARD:  
STRUCTURE OF RADIO STATION LIST  
The radio stations found in the automatic search were divided into appropriate station blocks according to the previously selected antenna cables (signal sources). The stations can only be reorganised later within these blocks. The block with the stations of your favoured signal source is at the top of the station list.

Signal source(s)	Associated station numbers
ASTRA1 19,2°E	1- 300
DVB-C	301-500
DVB-T	501-700
Antenna/cable (analogue)	701-900

The structure of the radio station list is displayed.

OK Proceed.

Age-related lock

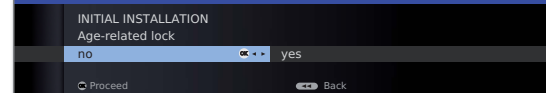

◀ ▶ Select Age-related lock.

You can specify an age limit for your TV set here. DVB broadcasts which have an appropriate age identification are locked and can only be watched after entering the access code (see page 52).

OK Proceed.

continued on next page →

# Initial installation

## Time and date

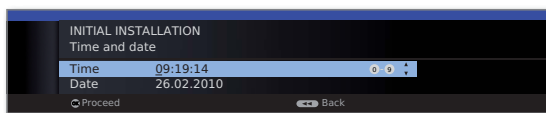

- ▲ ▼ Select time / date.

If no values or no correct values have been entered for the data and time, enter the correct values with the numeric buttons here.

**OK Proceed.**

## Sound playback via ...

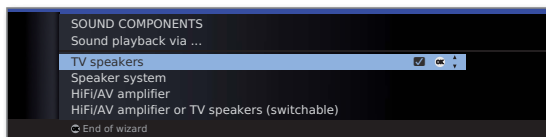

- ▲ ▼ Select sound components.

This selection indicates which sound components you want to use to hear your TV sound. Depending on the selection, the sound component wizard starts with which you can make further settings.

The sound component wizard is described from page 91 and can also be started at any time outside of first time operation (**TV menu** under **Connections** → **Sound components**).

**OK Proceed.**

## Network configuration

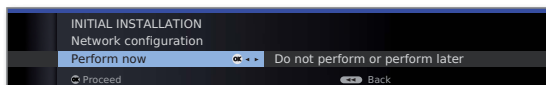

- ◀ ▶ Select the option.

With the selection, specify whether you want to configure the available network adapter now. For **Perform now** see **Media menu** from page 57 onwards. For **Do not perform or perform later**:

**OK End of wizard.**

## Positioning/aligning DVB-T antenna

If you are receiving one or more DVB-T stations with picture and sound interference then you should change the installation location and alignment of the antenna. Ask your dealer to tell you which channels are used to broadcast the DVB-T stations in your region.

- ➡ In normal TV mode, without other displays. A DVB-T station is received and selected.



**MENU:** Call **TV menu**.



- ◀ ▶ Select **Settings**,
  - ▼ go to the menu line below.
- ◀ ▶ Select **Stations**,
  - ▼ go to the menu line below.
- ◀ ▶ Select **Manual adjustment**,  
**OK** call manual adjustment.

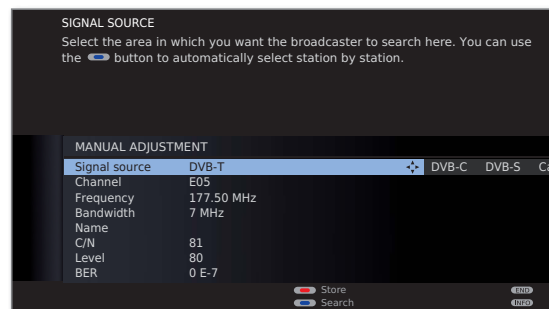

The signal source is already on DVB-T due to the station preselection.

Position and align the antenna in such a manner that maximum values for **C/N** and **Level** are obtained.



**Blue button:** Start search.

Search for DVB-T stations one after another and compare values for **C/N** and **Level**. Then position/align the antenna to the weakest station so that maximum values for **C/N** and **Level** are obtained. The value for **BER** should be as low as possible.

Thereafter perform an automatic search for all DVB-T stations (see page 41).

# Daily operation

## Select station

### Select station with P+ / P-

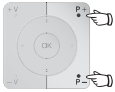

**P+ / P-** Station up/down.

The status display with station title, progress bar, time and sound identification signal is shown briefly (see page 39).

- If Favourites are selected, you can change to the corresponding station in the Favorites list using **P+ / P-** (see page 32).
- The symbols for the sound identification are described on page 39.
- If there are additional languages or DVB subtitles for DVB stations, then language and subtitle selection is shown below the station display. See also page 40: Selection possibilities for DVB stations.

### Select station using the numeric buttons



long

#### 1-digit stations

Hold the **numeric button** down for a little bit longer: The channel will change immediately.

OR:

Press the **numeric button** briefly, the station changes after 2 seconds (changes immediately in case up to 9 stations are stored).

#### 2-digit (and 3-digit) stations

Press first (and second) **numeric button** briefly.

Hold the last **numeric button** down for a little bit longer: The channel will change immediately.

OR:

Press all the **numeric buttons** and the channel changes two seconds after the last number was entered (up to 99 or 999 saved channels it will change immediately).

#### 4-digit stations

Press all four **numeric buttons**, the station changes immediately.

- If Favorites are selected, you can change to the corresponding station in the Favorites list using the numeric keys (see page 32). Maximum two-digit station numbers are possible.
- If you select an unoccupied station slot, the next available station is switched to.

### Select station with the station list

- In normal TV operation, without further displays, no favourites selected:

#### OK Call Station list.



Sorting numerically



**P+ / P-** Scroll in the pages of the station list.



◀▶ Jump to the next station block.



▲▼◀▶ Mark stations.

OR:

Input the channel number.

The marker will switch to the selected station. The marked station is shown as a small picture.

**OK** The marked station is called.



**Blue button:** Changes the sorting between **numerically** and **alphabetically**.

Sorting alphabetically

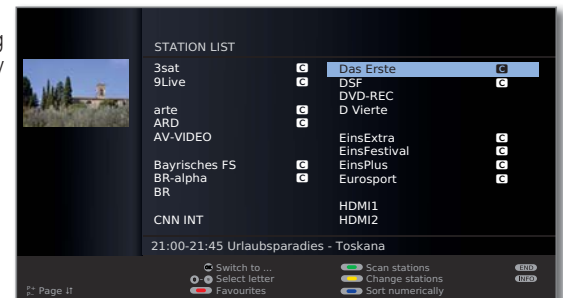

Input the first letter (see also page 12).

The first station for the specified letters is marked.



▲▼◀▶ Mark stations.

**OK** The marked station is called..

# Daily operation

## Select station via favourites list

You can save and call your favourite stations in 6 favourites lists (e.g. for multiple users). Each favourites list can contain up to 99 stations. After initial installation, 10 stations from the station list are already stored in the first list. Change the favourites list to suit your requirements (see **Put together / change favourites lists** on page 44).

-  In normal TV mode, without other displays:  
**OK** calls the station list.
-  **Red button:** Calls up the last used favourites list.

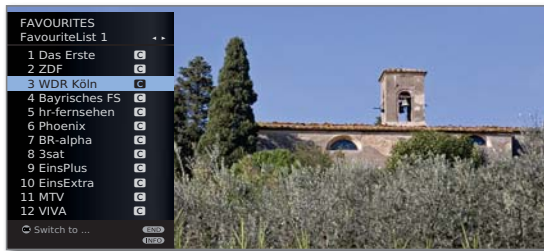

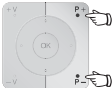

-  **P+/P-** Scroll in the pages of the favourites list.

Select station directly with **numeric buttons**. Or:

- 
  - ▲ ▼ Mark stations.
  - ◀ ▶ Select other favourites list.
  - OK** The marked station is called.

Other favourites lists can only be selected if these contain stations.

-  **Red button:** Back to the station list.
-  **Green button:** Scan all stations of the currently selected favourites list.
-  **Yellow button:** Change the Favourites lists, see page 44.

## Explanation of the favourites lists:

The selection made with the red button (favourites list) is retained until you switch back to the station list with the red button.

If favourites are selected, the name of the favourites list appears in the status display after the station name after changing stations.

## Explanation of the icons following station names:

- T** DVB-T station (digital terrestrial via antenna)
- C** DVB-C station (digital via cable)
- S** DVB-S station (digital via satellite)
- CT** Coded station
- CI+** CI Plus coded station
- A** Locked station (see Parental lock on page 52)

## Selecting Audio/Video Source

### Select the AV source via the AV selection

➡ In normal TV mode, without other displays:



Call **AV selection**.



▲ ▼ Select desired connection,  
**OK** switch over.

If the selected AV source provides a signal (picture), it should be visible now.

For the **VIDEO** selection the set switches to programme place 0 (signal source cable (analogue), factory setting channel E36). The TV set shows the signal of a provider via antenna (see page 88). The channel can be changed as required (see page 42).

### Select the AV source via station list

➡ In normal TV mode, without other displays:



**OK** Call the station list.  
If the favourites list is displayed, switch to the station list first.

The connections are always at the beginning of the list in numerical sorting.

The connections are sorted into the list in alphabetical order in alphabetic sorting.



▲ ▼ ◀ ▶ Select connection.  
**OK** Switch over.



# Daily operation

## Adjusting the sound

### Switching sound off/on



Sound off.  
Sound on again: Press the button again or increase the volume using **V+**.

### Setting the volume



**V+ / V-** Volume louder / quieter.  
The volume bar will be shown briefly if no other menu is displayed.

### Call Sound adjustment



Call **Sound adjustment**.



▼ Go to the menu line below.

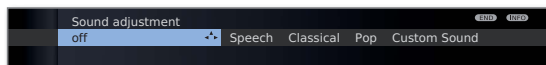

◀ ▶ Select sound adjustment.

### Additional sound settings

⇒ As long as the volume bar or the selection of the sound adjustment is still visible:



▲ Call additional sound settings.

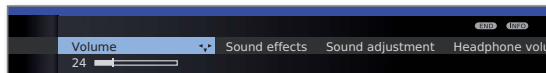

◀ ▶ Select sound setting,  
▼ go to the menu line below.  
◀ ▶ Make changes.

### Sound settings via the TV menu

⇒ In normal TV mode, without other displays.



**MENU:** Call **TV menu**.



◀ ▶ Select **Sound**,  
▼ go to the menu line below.  
◀ ▶ Select desired sound setting (right column),  
▼ go to the menu line below.  
◀ ▶ Make changes.

### Explanations of the sound settings:

Sound via Playback over the TV speakers or an external hi-fi amplifier.  
The menu item **Sound via** only appears if **HiFi/AV amplifier or TV speakers (switchable)** is set in the audio components wizard.

Sound effects Set sound effects Stereo, 3D Surround. **3D Surround** converts a stereo signal into a virtual surround signal.

Sound adjustment Speech, Classical, Pop, Custom sound.

Headphone volume Adjust the headphones volume.

Loudness Turn on/off aurally-compensated elevation of high and deep sounds at low volume.

Sound-picture synchronisation If the sound does not exactly match the picture, you can correct it here. If you move to the left in the bar you delay the sound in relation to the picture. If you move to the right you accelerate it in relation to the picture. The sound is adapted in time steps of 10ms each.

The Sound-picture synchronisation menu item only appears for DVB stations.

**more ...** Call with **OK** (see next page).

# Daily operation

## Explanations of the sound settings:

### more ...

- Loudspeaker/ Headphone sound** For analogue stations: In the case of programmes with twin sound, you can select separately between Mono/ Stereo or Sound 1 or Sound 2 for the loudspeakers and the headphones.
- Auto volume** Reduces volume differences, e.g. for advertisements that are too loud.
- AV output signal** You can specify here which soundtrack is to be output at the AV socket in the case of dual-soundtrack broadcasts from analogue stations: Sound 1 (e.g. main language), sound 2 (e.g. foreign language), or sound 1+2 (both simultaneously).
- Maximum volume** Determining the maximum volume that can be set.
- Max. switch on volume** Specify the volume that is set when switching on the TV set with the mains switch.  
If the volume is higher when switching the TV set to the standby mode than specified here, then it is reduced automatically to the fixed maximum switching on volume when it is turned on again.
- Balance** Set stereo balance so that the volume impression is identical on the left and right.

# Daily operation

## Adjusting the picture



**MENU:** Call TV menu.



- ◀ ▶ Select **Picture**,
- ▼ go to the menu line below.

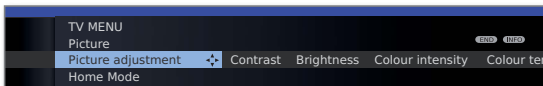

- ◀ ▶ Select the desired picture function,
- ▼ go to the menu line below.
- ◀ ▶ Make changes.

### Explanations of the picture settings:

**Picture adjustment** You can switch between three fixed picture setting variants and the three personal picture values that you have set here (see page 36).

**Contrast** The contrast setting depends on the brightness of the room. The brighter the surroundings the higher the contrast should be set.  
The power consumption of the TV set is directly dependent on the value set here (see also page 22).

**Brightness** Set the brightness so that the black areas of the picture only just appear black.

**Colour intensity** Set the colour intensity to suit your personal taste. The colours should appear natural.

**Colour temperature** Here, you can give the TV picture a warmer or colder hue according to your personal taste.

**Sharpness** Here you can adjust picture sharpness to obtain the best definition.

**Auto dimming** If this auto dimming is active then the television picture contrast is automatically reduced when the room brightness diminishes (Optical Power Control – OPC). This will also reduce the power consumption of the TV.

**more ...** Call with **OK** (see right hand column).

### Explanations of the picture settings (continuation):

**Image enhancement** Turn image enhancement on/off.

**Picture format** Set picture format (see page 36).

**Move picture up/down** Move picture vertically (see page 36).

**Auto format** Automatic detection and setting of the picture format for Cinemascope or widescreen movies.

**Film quality improvement (DMM)** DMM reduces jolt in rapid picture object movements and rolling text displays. This applies especially for movies.

**Digital Noise Control (DNC)** With active DNC (Digital Noise Control) you can eliminate or reduce picture noise.

**PC IN display** Set the geometry of the picture (see page 90).

# Daily operation

## Selecting the picture format

► The picture format cannot be altered if an HbbTV application is active (see page 68).



Press the **Picture format button** until the desired picture format is set or press

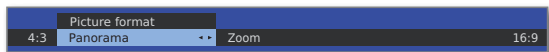

◀ ▶ to select the desired picture format.

The **Panorama** picture format can be set between proportionally correct and format filling display. Black bars are visible on the left and right of the picture in the proportionally correct display.



Switch: Keep the **M button** on the TV pressed, at the same time, press the **Picture format button** on the remote control briefly.



Reset: Press the same button combination again.

## Explanations of the picture formats:

► The setting options depend on the transmitted picture content.

16:9 Proportionally correct display of 16:9 broadcasts.

4:3 Proportionally correct display of 4:3 broadcasts.

**Panorama** Proportionally correct or format filling display (as-delivered state) of 4:3 broadcasts on the 16:9 screen. Station logo and subtitles remain visible.  
See above for switching the Panorama mode.

**Zoom** Maximum enlargement of the picture with proportionally correct display.

**PALplus** Is a 4:3-compatible 16:9 picture broadcast supplied by the station which is detected automatically.

If a high resolution video signal is displayed on the TV set or fed in via the interfaces PC IN, HDMI1 or HDMI2, the picture formats 16:9 PC, 16:9 TV, 16:9 Zoom, 4:3 PC, 4:3 TV and 4:3 Zoom can be set.

In the PC formats, the complete picture content will be shown. In the TV formats a small part of the picture is cropped. This may be necessary to hide possible interference at the edge of the picture, which arises from the signal supplied.

## Move picture vertically

► In normal TV mode without other displays.

▲ ▼ Move picture up/down.



To show subtitles or news tickers which have been cut off, the picture can be moved up or down in the picture formats **Panorama**, **Cinema** and **Zoom** (not with high resolution signal) with the **arrow buttons** ▲ ▼.

## Set presets / personal settings for picture adaptation



**MENU:** Call TV menu.



◀ ▶ Select **Picture**,  
▼ go to the menu line below.

◀ ▶ Select **Picture adjustment**,  
▼ go to the menu line below.

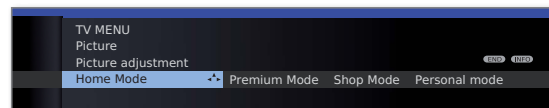

◀ ▶ Select the desired setting.  
**OK** Confirm selection.

## Explanations for Picture adjustment:

By selecting the presets **Home Mode**, **Premium Mode** or **Shop Mode**, the picture settings for contrast, colour intensity, colour temperature, brightness, sharpness and digital noise suppression for whichever signal input group that is currently active will revert back to the predefined settings. See glossary for an explanation: **Signal input groups**.

Your personal settings for these are saved under **Personal mode**. Here you can input your own specifications for each signal input group.

All picture and sound adjustments can be reset to the default values in one step for all signal input groups in the index of the TV set under **Reset picture/sound** or **Factory settings picture/sound**.

# Daily operation

## Button functions





Every operating mode of the TV set (TV, Radio, MediaPortal, Teletext, EPG and archive<sup>1)</sup>) has its own menu and own functions for the coloured buttons.





The function of the coloured buttons is shown at the bottom of the menus and wizards.

Below, some of the function are listed which you need in TV mode for the daily handling of your TV set.

### Coloured buttons in TV mode

➡ In normal TV mode, without other displays.

    **Red button:** Load up or start an interactive data service such as HbbTV (if available; see page 68).

    **Green button:** Call up subtitles.  
➡ The operation of subtitles depends on the station selected.

#### Subtitles only for analogue stations:

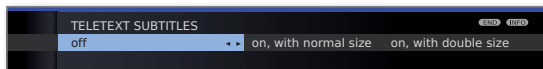

◀ ▶ Select the size of the teletext subtitles,  
**OK** show teletext subtitles

➡ Subtitles are only shown where they are available.







**END:** Teletext subtitles off or select **off** in menu.

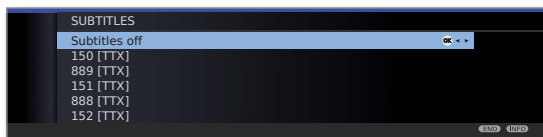



#### Subtitles for DVB stations:

➡ The DVB subtitles can also be selected via the status display (see page 40).





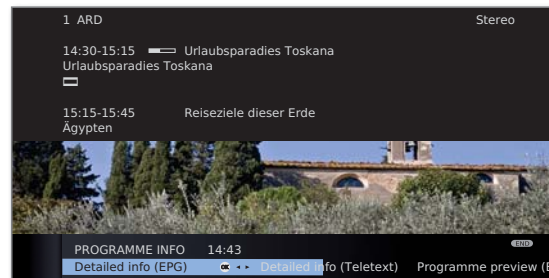

▲ ▼ Select subtitles,  
**OK** show/hide subtitles.

    **Yellow button:** Go to the last viewed station.  
Use this button to quickly switch back and forth between two stations.

    **Blue button:** Show the programme info for the programme currently playing and the one to follow.



Explanation of the symbols in the programme information:

-  Programme in 16:9 picture format
-  Programme in high picture definition (HDTV)
-  Programme with Dolby-Digital sound
-  Broadcast of subtitles for the deaf and hard of hearing
-  Programme with youth protection (see **Parental lock – Age-related lock** on page 52).

The symbols may also appear in combinations.

<sup>1)</sup> Only if a USB storage device is connected.

# Daily operation

## Permanent display of time



Press twice in rapid succession:  
Time is shown/hidden permanently.



The permanent display of the time can also be set in the TV menu under **Settings** → **Miscellaneous** → **On-screen displays** → **Permanent clock display** (see page 54).

The display position of the time depends on the selected setting in the On-screen displays menu (ex-factory: bottom). See page 54 for how to change the display position.

## Operation without remote control

### Changing the station on the TV set



+ / - Station up/down.

### Switching radio on or off or switching to radio



**R** Radio on or switch between TV and Radio.

### Calling the TV menu on the set



**M** Call **Direct control on TV set** menu,

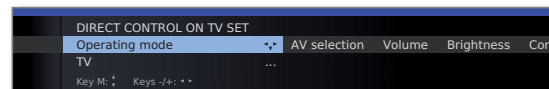

- / + select function.

**M** or **R** Go to the menu line below,  
- / + make changes.

**M** Move up one menu line,  
- / + select other function.

### Explanations of the settings:

Operating mode Switch between TV and radio operation.

AV selection Select AV source.

Volume Set volume.

Brightness Set brightness.

Contrast Set contrast.  
The power consumption of the TV set depends directly on the value set here (see also page 22).

Picture format Set picture format (see also page 36).

Station Select station +/-.

Service The Service menu item is provided for service purposes by dealers only.

# Daily operation

## Status display

➡ In normal TV mode, without other displays.

INFO

**INFO:** Show status display.

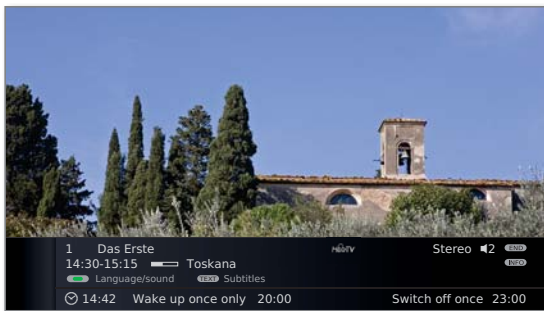

In the upper two lines, you will see the number and name of the station, the title and transmission time of the programme currently showing (if available) and the sound identification signal.

The bar (if available) indicates the progress of the current programme.

If information about the current programme is available, this can be called by pressing the **INFO button** again; in this case the button on the right is displayed.

A selection of functions, the time and, if activated, the alarm time and switch-off time will appear in the two lines below depending on the DVB station (see page 40).

The status display (except the last line) will also be displayed automatically each time you change the channel.

The status bar is hidden automatically at the end of the display time (see page 54 for setting).

If you want to hide the status bar manually before the display time ends, you can only do this with the **END button**.

## Explanations of the symbols in the status display:

General symbols:

**HbbTV** HbbTV mode is on and HbbTV applications are available

Transmitted audio signal:

**Mono** Mono audio transmission analogue  
**2-sound** Two-sound transmission (sound 1/sound 2) analogue  
**Stereo** Stereo sound transmission analogue

# Daily operation

## Selection possibilities for DVB stations

Additional selection options are shown in the status display for the individual programmes (depending on the DVB programme provider).

- ➡ If you press the **green button** or the **TEXT button** whilst the status display is showing, the appropriate selection menu will be displayed.
- ➡ The selection line is also displayed automatically when a new broadcast with different options to the previous broadcast begins or when you switch stations.

The selection menus are only available as long as the status display is shown. However you can call them again by pressing the **INFO button**.



**Green button:** Language/sound

The sound formats on offer and their designations depend on the programme being broadcast.



**TEXT:**

Subtitles

The subtitles available depend on the programme being broadcast

## Other setting options for DVB stations

You can make general presettings for DVB stations under **TV menu** → **Settings** → **Miscellaneous** → **DVB settings**.

Subtitle mode	Here you can preset whether a subtitle is always to be displayed as soon as it is offered by the station. A special subtitle for impaired hearing can also be selected. Subtitles are not offered by all stations. Many stations only broadcast subtitles by teletext.
Audio mode	Here you can preset whether you always want to hear a special sound for impaired sight as soon as it is offered by the station.
DVB character set	Select the DVB character set so that the title of the broadcast of your favourite received station or the texts of your CA module are displayed correctly.
Standby Search	The set can search the DVB network for changes after it has been switched off. The channel list is then automatically updated. Newly found channel are saved and channels that are no longer present are deleted.



# Managing stations

## TV stations

Various options for managing stations are available via the TV menu. For example the description for TV stations. For radio stations the same applies, except that the Radio menu is called in Radio mode (see also page 48).

- ➡ Station management is not possible if a programmed timer recording is still pending.
- ➡ If even one station is locked, you will have to enter your PIN before performing a station search or updating a station (see Parental lock on page 52).

### Search/update stations – Search wizard

In the search/update with the search wizard, new stations are searched for which have not yet been stored.

- ➡ You have to repeat the initial installation (see page 22) and automatically search for new ones if you want to delete all the existing stations and automatically search for new ones.



**MENU:** Call TV menu.

- ◀ ▶ Select **Settings**,  
▼ go to the menu line below.
- ◀ ▶ Select **Stations**,  
▼ go to the menu line below.
- ◀ ▶ Select **Search wizard**,  
▼ go to the menu line below.

In the upper info text the current search settings will now be displayed:

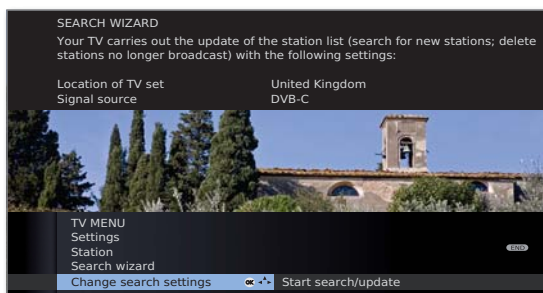

If you want to change these search settings:



- ◀ ▶ Select **Change search settings**,  
**OK** wizard prompts search settings.

If you agree with these settings:

- ◀ ▶ Select **Start search/update**,  
**OK** start search.

### Explanations of some search settings:

- Set location** Select the country for country-specific defaults and station sorting.
- Signal source** Select cable (analogue), DVB-T, DVB-C or DVB-S here depending on which signal source you want to search for new stations.  
A configuration of DVB-T and DVB-S antennas can also be called by the **green button** (see also page 23 and 24).
  - ➡ Calling up the DVB antenna configuration causes the **Change search settings** dialogue to be quit. You must call up the dialogue again after finishing the configuration.
- Cable (analogue)** With selection of set location the conventional TV standard/TV/colour standard is the default. This should only be changed if stations with other standards are to be searched.
- Search method** If you want to run the station search independently of the channel grid, select **frequency search** for the search method.
- Encrypted stations** You can state whether coded stations are to be searched for in the search/update. You will only be able to receive encrypted stations if you have a CA module and a corresponding Smart Card. Ask your dealer which Smart Card you need to receive certain stations. Handling of the CA module is described on page 55.
- DVB-C Settings** With the selection of set location the conventional settings will be preset. Only change these defaults if you are familiar with other settings or if you have to specify the network ID for your cable network (information available from your cable network provider).
- DVB-S Symbol rate** The symbol rate is specified by the satellite provider and normally does not need to be adjusted.



**Red button:** Abort current search/update.

# Managing stations

## Search for/update stations – handling of new and no longer found stations

The number of new stations found is displayed after the automatic search/update has been completed.



### OK List of new stations found



▲ ▼ ◀ ▶ Select station.



**Yellow button:** Mark / unmark station

**Blue button:** Mark / unmark all

**OK** saves the selected stations.

Afterwards, a list of the stations which are saved but which are temporarily not broadcasting or no longer exist is displayed, if available.

The number of the memory location used is displayed in front of the station. Please select the stations you really want to delete.

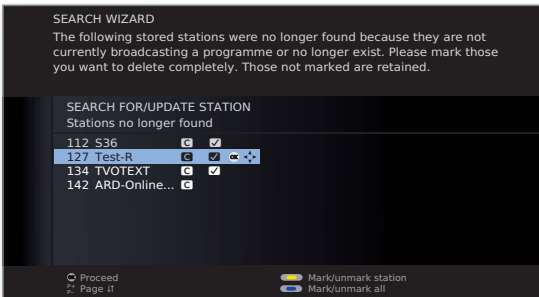

▲ ▼ ◀ ▶ Select station.



**Yellow button:** Mark / unmark station

**Blue button:** Mark / unmark all

**OK** deletes the selected station.

END

**END:** Exit the search wizard.

## Search/update station – manual search / settings

➡ If you want to adapt the parameters of an existing station, first select the appropriate station.

MENU

**MENU:** Call TV menu.



◀ ▶ Select **Settings**,  
▼ go to the menu line below.

◀ ▶ Select **Stations**,  
▼ go to the menu line below.

◀ ▶ Select **Manual adjustment**,  
**OK** call.

You can enter or edit the station data in the following lines:

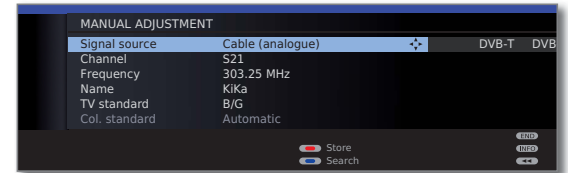

Or:



**Blue button:** Starts **Search** and searches for next station.

**Red button:** Stores station.

➡ Only stations for the selected signal source can be saved which do not yet exist in the station list.

➡ Stations which already exist in the station list for the selected signal source are displayed with their station numbers and names on a grey background. These stations can only be overwritten with the **red button**.

## Explanations of some search settings:

Various settings are possible depending on the selected signal source. Some settings have already been explained in the initial installation (see page 22 onwards).

**Signal source** Selection of range in which you want to search for the station.

**Channel** Direct input of channel.

**Frequency** Direct input of station frequency.

**TV stand.** Input of station TV standard.

Ask your dealer in this regard.

# Managing stations

## Change, delete, move, rename, restore station

- ➔ **Change station** can also be called via the station list (page 31).
- ➔ If at least one station is locked the access code must be entered before changing stations start-up (see Parental lock on page 52).
- ➔ In some TV broadcasting networks (e.g. FreeView) you are not allowed to move or rename stations. Use **Favourites** instead.



Call **TV menu**.

- ◀ ▶ Select **Settings**,  
▼ go to the menu line below.
- ◀ ▶ Select **Stations**,  
▼ go to the menu line below.
- ◀ ▶ Select **Change stations**,



In this menu you can delete, move, rename or restore stations.



- ◀ ▶ ▲ ▼ or **numeric buttons**:  
Select the appropriate station.  
Scroll with **P+/P-** if necessary.

## Delete station



**Red button**: Starts **Delete** station.

- ▲ ▼ Select several stations to be deleted if necessary,  
**OK** to execute the delete.

## Move station / Change order

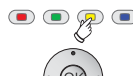

➔ Stations can only be resorted within the signal source block.

**Yellow button**: Starts **Move** station.

- ▲ ▼ Mark several stations if needed,  
**OK** selection ended,
- ▲ ▼ Select insertion position from which the selected stations are to be inserted,  
**OK** to execute the move.

## Rename station

- ➔ DVB stations for which the station name is also broadcast cannot be renamed. In this case, the **Rename** function is hidden.



**Blue button**: Starts **Rename** station.

Under the first letter of the name you will see a line indicating the current input position.



- ▶ Input position one character to the right (also for blanks).
- ◀ Input position one character to the left.



Input the letters one after another. When using the remote control, press the **numeric buttons** just as on a telephone keypad until the desired symbol is displayed. The available letters are printed respectively on the buttons. See page 98 for a detailed overview of the available characters.



**Green button**: Switch upper/lower case letters.

**Yellow button**: Delete the character before the insert position.

**Blue button**: Cancel rename.



**OK** to save new name.

## Restore stations

Stations which have been deleted from the station list can be restored.



**Green button**: Starts **Restore** stations.

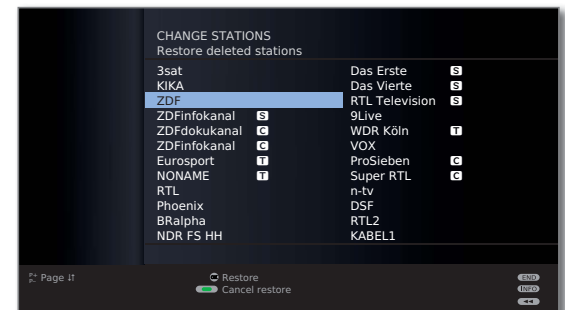

- ▲ ▼ ◀ ▶ Select station,  
**OK** station is restored.

The restored station is sorted in according to its signal source at the end of the respective signal block.

# Managing stations

## Put together / change favourites lists

Each favourites list can contain up to 99 stations. You can put together the favourites lists to suit your requirements (e.g. topic lists). Other persons using this TV set can create their own favourites lists.

The favourites lists also have the advantage that the stations of different signal sources can be stored in the order you wish.

⇒ **Change favourites** can also be called via the favourites list (page 32).

MENU



**MENU:** Call TV menu.

◀ ▶ Select **Settings**,  
▼ go to the menu line below.

◀ ▶ Select **Stations**,  
▼ go to the menu line below.

◀ ▶ Mark **Select/change favourites**,  
**OK** call list of all stations (left column) and last active favourites list (right column).



**Green button:** Select the next favourites list in the right column.

## Rename favourites list

⇒ Favourites list (right column) must be selected.  
If not, change the list with ▶.



**Blue button:** Starts **Rename favourites list**.



Enter new name (same procedure as for rename station, see page 43).



**OK** to save new name. Or:



**Blue button:** **Cancel rename**.

## Add station to favourites list

⇒ All stations (left column) must be selected.  
If not, change the list with ▶.



**P+/P-** Scroll in the pages of the station list if necessary.



▲ ▼ Mark station or select station with the **numeric buttons** (for alphabetical station sorting enter the initial letter) which is to be transferred as a favourite to the favourites list.



**OK** transfers the station to the favourites list.  
The new station is inserted at the end of the favourites list. Proceed in the same manner with additional stations.

## Delete station from favourites list

⇒ Favourites list (right column) must be selected.  
If not, change the list with ▶.



▲ ▼ Mark station to be deleted.

**OK** Removes the marked station from the favourites list.

or:



**Red button:** Starts **Clear favourite list**.



**OK** confirms clear favourites list.

## Move / change order of stations in the favourites list

⇒ Favourites list (right column) must be selected.  
If not, change the list with ▶.



▲ ▼ Mark station to be moved.



**Yellow button:** Starts **Move station**.



▲ ▼ Select insertion position at which the marked station is to be inserted.



The insertion position can also be selected with the numeric buttons.



**OK** to execute the move. Or:



**Yellow button:** **Cancel move**.

# Electronic Programme Guide

## Electronic Programme Guide – EPG

EPG stands for Electronic Programme Guide and provides you with on-screen programme details. With the system, as with a printed programme guide, you can learn about the current programme. In addition programmes can be sorted according to certain topics, memorised, and also recordings can be programmed.

### Starting and ending EPG

EPG

**EPG:** Switch EPG on / off.

- ➔ EPG is only available for DVB stations.
- ➔ The first time you start EPG, an assistant will guide you through the necessary presettings.



The display of the programme guide is divided into two branches. The specifications in the upper section limit the scope of the stations displayed in the lower section.



**Blue button:** Switches between the upper default lines **Date, ..., Topics** and the lower programme list.

### Switching and memorizing with the programme list

- ➔ You are in the lower programme list, if not, press the **blue button**.



- ▼ ▲ Select station.
- OK** View / Memorise.

**View** The programme is in progress. The TV set switches to the marked programme.

**Memorise** The programme has not started yet and is memorised. A  will appear in front of the station title. The TV will ask at the beginning of a programme if it should change the channel or switch on from the stand-by mode if the corresponding option of the EPG menu is activated (see page 46).

- ➔ Programmes can also be noted by the timer list (see page 77).

### Adjusting the programme list

- ➔ The selection is at the top of the specifications, if not, press the **blue button**.



- ▼ ▲ Select **Date, Time, Stations** or **Topics**.
- ◀ ▶ Select defaults within the respective line.



**Example** If you are searching for the next news, select today's date, **17:00** for example for the time, **all** for station and **News** for topics. Then you get a list of all news programmes from 17.00 h onwards in the programme list below it. The type of list of programmes in the programme list depends on the setting of the **sorting** in the EPG menu (page 46).

**Time entry** If the line **Time** is selected, then you can enter the time after which the programmes will be displayed, via the numeric buttons of the remote control. The broadcasts are sorted according to the order of the station list within the selected time window.

**Stations** If a **favourites list** has been selected, only the programmes of stations from the favourites list are displayed in the programme list. A single station can be selected with "...". The Select single station window is opened. After selection, only programmes of the selected single station are displayed.

**Hint** Before pressing the **blue button** to leave the upper selection lines, select one of the preceding lines. If you then switch back to the programme list, you can change this menu line with ◀ ▶, without having to leave the programme list. If you have marked **Time**, then you can enter the time, after which the programmes will be displayed, with the numeric buttons of the remote control.

# Electronic Programme Guide

## Paging through the programme list

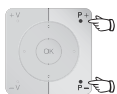

**P+/P-** Page backwards / forwards.

In the entries for **Date** and **Time**, you will see changes in time as well as in date when paging. Scrolling in the programme list is also possible when the selection is at the top of the specifications.

## Calling additional information about the programmes

➡ Brief information about many programmes is displayed below the programme list of the broadcasts.



You can call detailed information with the **TEXT button** if this function is offered by the TEXT icon in the lower left. The symbol explanations are described on page 37.

## Programming a recording for a recorder

- ➡ The selection is in the lower programme list, if not, press the **blue button**.
- ➡ The displayed page of the programme list includes the desired programme, otherwise browse to it or suitably limit via the specifications in the lower section.



▼ ▲ Mark the desired programme.



**RECORD button:** Timer data is called up.

Change or confirm timer data if necessary (see page 75).

Then a **red dot** will be displayed in front of this programme as an identification.



**RECORD button:** Deletes the already programmed recording of the red marked programme from the timer.

## Configuring EPG

### Start the EPG menu

➡ EPG mode is started, if not, press the **EPG button**.



**MENU:** Call the **EPG menu**.

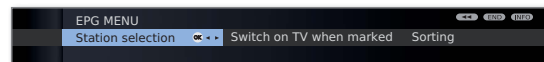

### Explanations of setting possibilities in the EPG menu:

**Station selection** In the **station selection** you can determine for which station in the programme guide information is to be displayed. Programme information will only be displayed in the EPG for stations that you mark with  here.

You can use the coloured buttons to mark the selected station, all stations, or just the stations in all favourites lists.

Because of the large number of receivable DVB-S stations you should restrict the station selection. This reduces the data entry time and increases the clarity in the EPG.

Marking the stations according to reception ranges:

- T** Digital terrestrial stations (DVB-T).
- C** Digital cable stations (DVB-C).
- S** Digital satellite stations (DVB-S).

**Switch on TV when marked** When **yes** is set, the switched off TV switches on automatically from the standby mode at the beginning of a set programme. A screen message appears when switching on. If this is not confirmed within 5 minutes with the **OK button**, the TV switches back off automatically for safety reasons.

**Sorting** The programmes can be sorted either according to their start times (**chronologically**) or according to stations (**corresponding to station list**).

# Teletext

## Teletext

Your TV set supports the two operating systems TOP Text and FLOF. Up to 1,000 pages are stored so that you have quick access.

### Starting and ending teletext



Switch teletext on / off.

➡ With default **HbbTV mode** → **on**, MediaText/HbbTV text opens when first pressing the **TEXT** button (see page 68).



### Page selection with the coloured buttons



**Red button:** Previous page.

**Green button:** Next page.

**Yellow button:** To next topic.

**Blue button:** To next range of topics.

The coloured bars (near TOP) or the coloured writing (near FLOF) in the last to bottom line show you which colour button you need to use to select which topic areas and topics.

### Teletext page displays



**0 AV:** Stop self changing pages.



**9:** Enlarge page (press several times).

### Additional page selection possibilities



**1st possibility:**  
Call **overview page 100**.

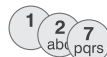

**2nd possibility:**  
Directly enter the page number.

**3rd possibility:**

➡ The page consists of several sub-pages.



◀ ▶ Page through sub-pages.

### Show hidden information



Shows hidden information, e.g. for the answers to quiz questions.

### Select teletext character set

The teletext character set can be set to other languages (West, East, Cyrillic, Greek, Turkish, Arabic).



**MENU:** Call **TV menu**.



◀ ▶ Select **Settings**,  
▼ go to the menu line below.

◀ ▶ Select **Miscellaneous**,  
▼ go to the menu line below.

◀ ▶ Select **Teletext character set**,  
▼ go to the menu line below.

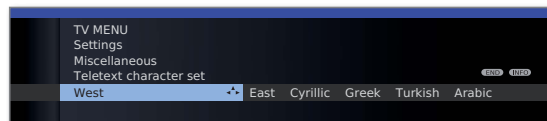

◀ ▶ Select desired character set,  
**OK Adopt** character set.

# Digital radio

## Radio mode (DVB radio)

The TV set can receive digital radio stations over DVB or over the internet (see page 50).

In addition you can play the sound from an external device through the TV set via the audio/AV inputs of the TV set (see page 51).

- ▶ The **AUDIO button** has been preset for radio operation in the factory. To change the configuration see page 95.

### Radio mode on



Press **AUDIO button** on the remote control. The radio mode that was last selected will be opened (DVB or internet radio).

Or:



**MEDIA:** Call **MediaPortal**.



◀ ▶ ▲ ▼ Select **DVB radio**,  
**OK** call.

Or:



**R** on the operating ring on the TV set.

You see an information window about the currently set station.

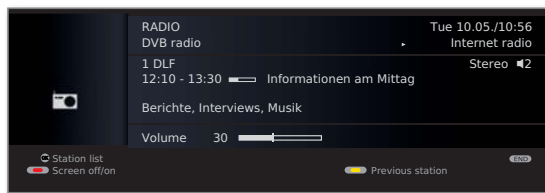

If a connection to the internet is already established:



◀ ▶ Change between **DVB radio** and **Internet radio** (see page 50).

### Setting the volume



**V+ / V-** Volume louder / quieter.

Other sound settings are the same as for the volume setting in TV mode (see page 33).

### Station switching



▶ The selection of the stations / favourites is the same as the procedure in TV mode (see pages 31 and 32).

Press **P+ / P-** or the **numeric buttons** of the remote control.

Or:



**+ / -** on the TV set operating ring.

Or:



**OK** Call station list / favourites.

### Sound adjustment



Call **Sound adjustment**.

Other settings as for TV mode (see page 33).

### Switching the screen on/off



**Red button:** Switch off the screen.

Switching off the screen reduces the power consumption of the TV set.

The **LED display** on the TV set (see page 10) changes from green to orange.

Switch on the screen with the remote control:  
**Red button** or **OK button** (station list is opened).

Switch on the screen on the TV set:  
Press **R** on the TV set operating ring.





# Digital radio

## Radio menu

In the Radio menu, you can set the sound, search for and store radio stations (automatically or manually), change stations and set switch off/ alarm functions.

The settings are made as described in TV mode.

## Call Radio menu

➡ Radio mode switched on, if not, see page 48.

MENU

**MENU:** Call the **Radio menu**.

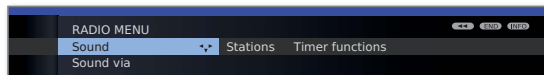

## Switch off radio mode

TV

Press **TV button** on the remote control.



Or:

**R** on the operating ring on the TV set.

## EPG – Electronic Programme Guide (radio)

You can also use an electronic programme guide for the DVB radio stations if the radio stations provide programme information.

## Starting and ending EPG

➡ Radio mode switched on, if not, see page 48.

EPG

**EPG:** Switch EPG on / off.



➡ The EPG functions in radio mode are the same as in TV mode. Read from page 45 onwards for further information.

## EPG configuration (radio)

The EPG settings in Radio mode correspond to those in TV mode (see page 46). If the EPG menu is called up in Radio mode, only radio stations will be included in the station selection.

As already indicated under EPG configuration in TV mode (see page 46), we recommend omitting all radio stations unimportant to you in the EPG station selection for Radio mode (do not highlight with )

This gives you a clearer overview in the EPG, as there are a large number of stations for the signal source DVB-S in particular.

The collection of EPG data can also be shorted significantly by this.

# Digital radio

## Radio mode (Internet radio)

The TV set can receive digital radio stations over DVB (see page 48) or over the internet.

In addition you can play the sound from an external device through the TV set via the **audio/AV inputs** of the TV set (see page 51).

- ▶ The **AUDIO button** has been preset for radio operation in the factory. To change the configuration see page 95.
- ▶ Internet radio is only accessible if a connection to the internet has been established.

### Radio mode on



Press **AUDIO button** on the remote control. The radio mode that was last selected will be opened (DVB or internet radio).

Or:



**MEDIA:** Call **MediaPortal**.



◀ ▶ ▲ ▼ Select **Internet radio**, **OK** call.

Or:



**R** on the operating ring on the TV set.

You see an information window about the currently set station. The station overview appears the first time you call up Internet radio (see right column).



◀ ▶ Change between **DVB radio** and **Internet radio** (see page 48).

### Setting the volume



**V+ / V-** Volume louder / quieter.

Other sound settings are the same as for the volume setting in TV mode (see page 33).

### Station list (internet radio)

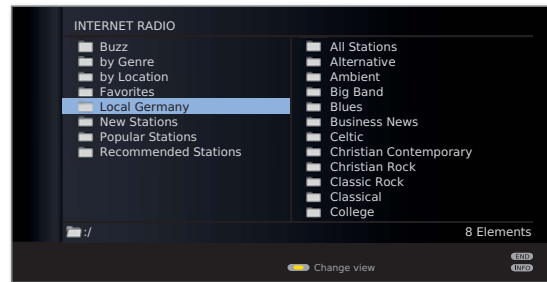

▶ When playing Internet radio stations, the folder names specified by the provider "vTuner" are adopted for display on the TV.

For further operation, see **General navigation in the media overview** on page 62.

### Sound adjustment



Call **Sound adjustment**.

Other settings as for TV mode (see page 33).

### Switching the screen on/off



**Red button:** Switch off the screen.

Switching off the screen reduces the power consumption of the TV set. The **LED display** on the TV set (see page 10) changes from green to orange.

Switch on the screen with the remote control: **Red button** or **OK button** (station list is opened).

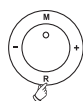

Switch on the screen on the TV set: Press **R** on the TV set operating ring.

### Internet radio favourites

You can find your Internet radio favourites in the **Favourites** folder in the Internet radio station overview (see above). The **Favourites** folder contains several subfolders. The **My Favourites** subfolder contains the favourite stations you have added directly to your favourites in the TV set (local favourites).



**Blue button:** Add the playing Internet radio station to **favourites**.

The station is added to the **My Favourites** subfolder.

You can also manage your Internet radio favourites conveniently via the Support homepage (see page 56).

### Switch off radio mode



Press **TV button** on the remote control.

# Digital radio

## Audio playback from external devices

You can play the sound of external AV devices (e.g. MP3 players, DVD players) in radio mode.

### Connecting an external appliance (e.g. MP3 player)

Connect the output (jack) of the MP3 player to the cinch audio in sockets L/R (white/red) of the TV set.

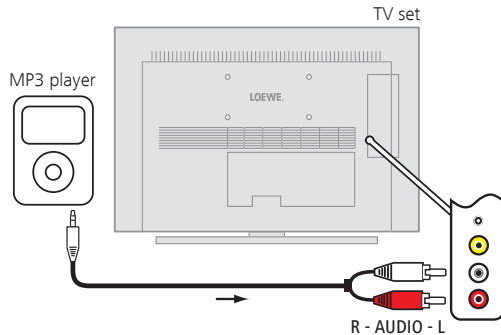

Connection example of an MP3 player

### Select AV input

➡ Radio mode switched on, if not, see page 48.



#### OK Open station list.

The AV inputs are listed before the first radio station in a numerically sorted list.



➡ The selection of the AV inputs is the same as in TV mode (see page 32).

Start playback on the external device after selecting the AV input.

# Other settings

## Parental lock

You can select and set various security options to prevent unauthorised use of the TV set and to protect your children from unsuitable programmes.

### Defining the access code (PIN)

MENU

**MENU:** Call TV menu.



- ◀ ▶ Select **Settings**,
- ▼ go to the menu line below.

- ◀ ▶ Select **Parental lock**,
- ▼ go to the menu line below.



Define a four digit access code (PIN) the first time you open it. The numbers appear in plain text. Note the access code (PIN) well.



**OK** Confirm the access code (PIN).

The **Parental lock** menu is opened.

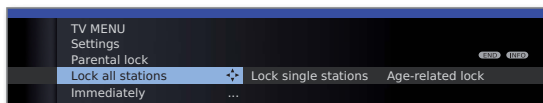

The four-digit access code (PIN) must be entered when the parental lock is opened in future. It appears encrypted (\*\*\*\*) when entering for security reasons.

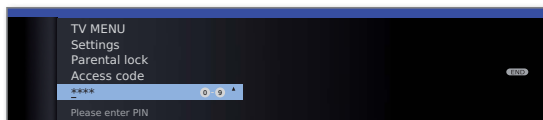

### Code number

The code number cancels all entered PINs. It can be used for example if you have forgotten your PIN. You will find a note about the code number on page 102. Remove this from the manual and keep it in a safe place.

### Explanations of setting possibilities in the Parental lock menu:

- |                      |   |
|----------------------|---|
| Lock all stations    | The TV set is locked immediately the menu is exited. All programmes can then only be watched after entering the access code. The lock can be activated both <b>Immediately</b> and for a <b>Daily</b> defined period. The lock remains active until it is switched off in the menu. |
| Lock single stations | You can lock / unlock individual stations in the station list specifically. The lock remains active until it is switched off in the menu.   |
| Age-related lock     | Some DVB stations also broadcast an age classification. If the age set here is below the broadcast age limit, the programme can only be watched after entering the access code.   |
| Change access code   | You can change your access code at any time. Enter the new access code in place of the old one.   |
| Deactivate           | All set parental locks (locked stations, age-dependent locks, locked films in the archive <sup>(1)</sup> ) are cancelled. The current secret code is deleted. When the parental lock is reactivated all the previous parental locks are set again automatically.                    |
| Reset                | All currently set parental locks are finally cancelled. The secret code is deleted.   |

### Protection of minors for CI Plus programmes

Youth-protected broadcasts of programme providers with CI Plus encoding possibly require you to enter the secret number (PIN) of the CA module.

We recommend selecting the secret number of the TV set according to the secret number of the CA module, since the secret number of the CA module cannot be changed. This means that you must only remember one secret number.

<sup>(1)</sup> Only if a USB storage device is connected.

# Other settings

## Timer functions

This menu offers you convenient alarm services. Programmed alarms are also active when the TV set has been switched off to standby.

If the TV set switches on from the standby mode by alarm, a screen message appears. If this is not confirmed within 5 minutes with the **OK button**, the TV switches back off automatically for safety reasons.

The TV set can also be switched off automatically at certain times. A screen warning appears one minute before automatic switch off. The automatic switch off can be interrupted by pressing any button.

### Call Timer functions



**MENU:** Call TV menu.



◀ ▶ Select **Settings**,  
▼ go to the menu line below.

◀ ▶ Select **Timer functions**,  
▼ go to the menu line below.

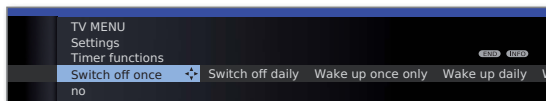

◀ ▶ Select the desired setting.

### Explanations of setting possibilities in the Timer functions menu:

- |                   |   |
|-------------------|---|
| Switch off once   | The set switches to the standby mode automatically at the specified time.<br>If a time is specified which has already passed on the same day, the set switches off at this time the next day. |
| Switch off daily  | The set regularly switches to the standby mode automatically every day at the specified time.   |
| Wake up once only | The set alerts you once at the specified time.<br>If a time was specified which has already passed on the same day, the alarm is saved for the next day.                                      |
| Wake up daily     | The set alerts you regularly at the specified time each day.  |

### Explanations of setting possibilities in the Timer functions menu:

- |                     |  |
|---------------------|--|
| Wake up with signal | Specify whether the TV set switches on in the event of an alarm from the standby mode in <b>TV</b> or <b>radio mode</b> with the respectively last active station. |
| Wake up volume      | Set the desired volume of the alarm tone. The alarm tone is emitted as a continuous tone as a guide during the setting.  |

## Language

Specify the language for all menus in the TV set in the language menu. The language for the DVB subtitles and the film language can be set for DVB programmes.

### Call language



**MENU:** Call TV menu.



◀ ▶ Select **Settings**,  
▼ go to the menu line below.

◀ ▶ Select **Language**,  
▼ go to the menu line below.

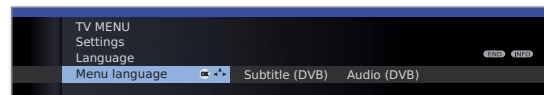

◀ ▶ Select the desired setting.

### Explanations of setting possibilities in the Language menu:

- |                |   |
|----------------|---|
| Menu language  | You can change the menu language here. The menu language can be changed with the index (see page 15).   |
| Subtitle (DVB) | If subtitles are provided by the DVB station, you can set your desired language in advance here. If this is included in the range of languages of the station, it will be shown automatically.<br>You can also specify an alternative language under this menu item, in case your chosen language is not offered by the station |
| Audio (DVB)    | Specify your desired film language in advance here. If this is included in the range of languages of the station, it will be shown automatically.<br>You can also specify an alternative language under this menu item, in case your chosen language is not offered by the station.   |

# Other settings

## On-screen displays

You can select different settings in this menu which affect the on-screen displays.

### Call On-screen displays

MENU

**MENU:** Call TV menu.



- ◀ ▶ Select **Settings**,  
▼ go to the menu line below.
- ◀ ▶ Select **Miscellaneous**,  
▼ go to the menu line below.
- ◀ ▶ Select **On-screen displays**,  
▼ go to the menu line below.

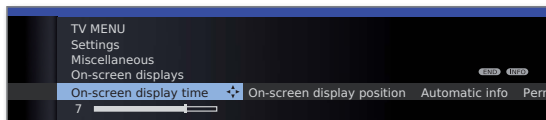

- ◀ ▶ Select the desired setting.

### Explanations of setting possibilities in the On-screen displays menu:

**On-screen display time** Here you set the duration of the display, e.g. for the volume or the station display when changing stations. The duration can be set between 2 and 9 seconds.

**On-screen display position** You can select between an upper and a lower display position so that other displays (subtitles) are not concealed.

**Automatic info** Select **yes** here if you want to be able to see the additional help permanently in the upper part of the screen while navigating the menu. Also see page 15 for further information.

**Permanent clock display** The time can be displayed permanently with this menu item or by pressing the button twice in quick succession (see also page 38). It is always visible as long as no other display is made.

**Automatic hint after switch to HDMI** If you switch to an HDMI programme place to which a Digital Link HD-capable device is connected, a reference to the adapted function of the remote control always appears when **yes** is set.

## Time and date

If you receive a station with teletext after switching on the TV, the time and date are recorded automatically. The date may have to be entered manually for some stations.

### Call Time and date

MENU

**MENU:** Call TV menu.



- ◀ ▶ Select **Settings**,  
▼ go to the menu line below.
- ◀ ▶ Select **Miscellaneous**,  
▼ go to the menu line below.
- ◀ ▶ Select **Time and date**,  
▼ go to the menu line below.

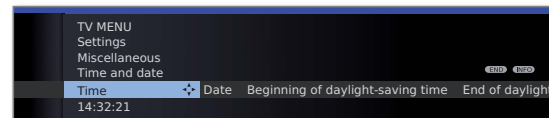

- ◀ ▶ Select the desired setting.

### Explanations of setting possibilities in the Time and date menu:

► If a definite time has been identified by the TV set (dependent on the channel), certain menu items may not be available.

**Time** Enter the time (00:00 to 23:59) with the numeric buttons of the remote control.

**Date** Enter the date (day.month.year) with the numeric buttons on the remote control.

**Beginning of daylight-saving time** Enter the date on which the time is switched over to summer time if it deviates from the automatically calculated date.

**End of daylight-saving time** Enter the date on which the summer time ends if it deviates from the automatically calculated date.

# Coded stations

## Conditional Access module (CA module)

In order to receive coded digital stations, a Conditional Access module (CA module) and a Smart Card must be inserted in the CI slot of your TV set (see page 11).

The CA module and the Smart Card are not part of the TV set's scope of delivery. They are usually available from your dealer. Loewe does not provide any guarantee for the functioning of the CA module.

The TV set must first recognise and set up the CA module during initial operation. Therefore, it can take up to a minute until decoding starts during initial operation.

### Inserting the Smart Card into the CA module

Push the Smart Card into the CA module as far as it will go. The side of the card with the gold chip on it should be pointing towards the thicker side of the insertion slot ( see illustration). Observe the direction of the arrow printed on the SmartCard.

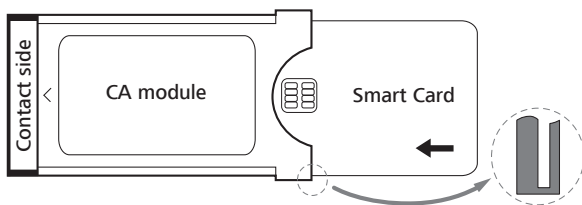

### Inserting the CA module into the TV set's CI slot

➡ Switch off the TV set's mains switch.

Open the side cover.

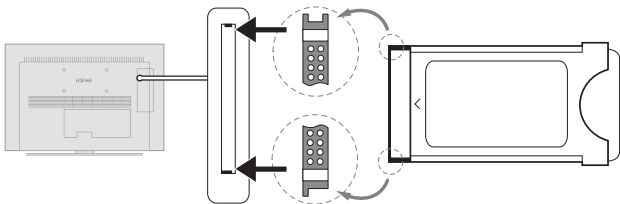

Insert the CA module carefully into the CI slot, ensuring that the contact side goes in first. Do not use any force when pushing it in. Make sure that the module does not go in at an angle. Push the CA module in as far as it will go.

Finally, close the side cover.

## Searching for encrypted stations

➡ The search wizard must only be started if the setting option **no** has been selected during first installation in the search for encrypted stations and no CA-module was inserted.

MENU



**MENU:** Call TV menu.

◀ ▶ Select **Settings**,  
▼ go to the menu line below.

◀ ▶ Select **Stations**,  
▼ go to the menu line below.

◀ ▶ Select **Search wizard**,  
▼ go to the menu line below.

◀ ▶ Select **Change search settings**,  
**OK** wizard guides you through the search settings.

See page 41 for a description of the search settings.

## Calling CA module information

➡ This menu is only available for digital stations and when a CA module is plugged in.

MENU



**MENU:** Call TV menu.

◀ ▶ Select **CA module: xxx**,  
**OK** call information.

The content of this menu depends on the provider of the CA module.

The CA module information can also be called up in the **TV menu** under **Settings** → **Other** → **CA module: xxx** (xxx corresponds to the CA module provider).

## Removing the CA module

➡ Switch off the TV set's mains switch.

Open the side cover.

Remove the module from the set.

Close the side cover.

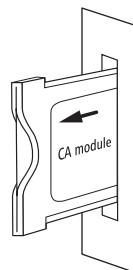

## General information on Media+

**MediaHome** gives you access to photos, videos and music from your personal storage media, e.g. from storage media connected via USB and from media servers in your home network to which your TV set is connected.

- ➡ Please follow the information in the right column for the Internet functions.

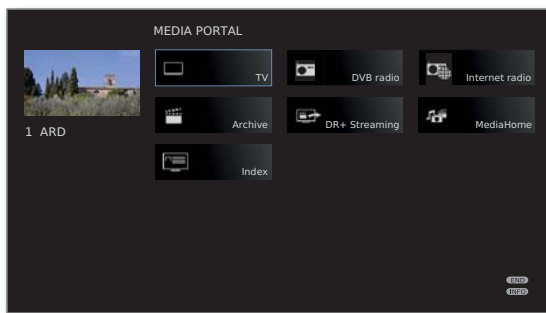

## Connecting the TV set to your network

To receive media via media servers in your home network or via the Internet, you have to integrate your TV set in your home network. You can connect your TV set both with a **wired connection** (Ethernet, PowerLine) or via a **wireless radio connection** (WLAN) <sup>(1)</sup>. You can find connection examples for both cases on page 19.

Your Loewe TV set supports the UPnP AV standard for data playback in the home network. You can find more detailed information on this in the technical data on page 104 and in the glossary from page 110 onwards.

## Internet radio

If you wish to use Internet radio, we recommend registering your TV set on our homepage.

<http://support.loewe.tv> (International),  
<http://support.loewe.tv/uk> (United Kingdom and Republic of Ireland),  
<http://support.loewe.tv/au> (Australia) or  
<http://support.loewe.tv/nz> (New Zealand)

(under **Register now** or **Register free-of-charge**).

Simply follow the steps in the registration process.

The MAC address of your TV set is required for the registration. You can find this in the index of the TV set under **Integrated features – MAC address (TV)**. After successfully registering your TV set, you can manage your vTuner Internet radio favourites. The list of content available to your TV set contains the sub-item **Internet radio**. Click on **Manage internet radio** to open a new window of your Internet browser. Here you can search for radio stations according to station location, country, language or category and add them to your Favourites. You can also organise your favourites in folders and delete added favourites.

- ➡ All your registered TV sets contain access to the favourites you have created via the website.

The favourites you have created are then displayed in the Internet radio station list in the subfolder **Favorites** (see page 50).

## Help for configuration problems

Loewe cannot provide any support for PC hardware and software or network components owing to the diverse configuration options with home networks.

Please contact the administrator of your home network and/or specialist dealer for support when setting up and for maintenance of network connections, storage media, media server software and network devices, e.g. routers.

## MediaUpdate - additional functions

Additional functions in the MediaPortal are planned, particularly for Loewe Media+. You can update your TV set yourself. You will find new software versions on our internet page.

You can find notes on carrying out a software update on page 96.



## Accessing your media

MEDIA

**MEDIA:** Call **MediaPortal**.

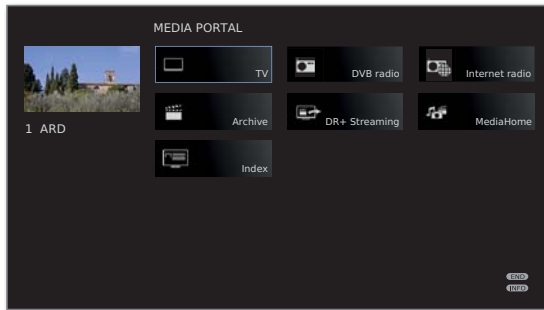

◀ ▶ ▲ ▼ Mark desired function,  
**OK** call function.

**MediaHome:** see page 61.

### Playing music and videos, displaying images

The windows for playing music and videos and for displaying photos are comparable for all cases irrespective of the media source. The relevant players are therefore grouped together:

**MediaMusic** (including Internet radio): see page 64.

**MediaPhoto:** see page 65.

**MediaVideo:** see page 66.

### Quit media

MEDIA

Call **MediaPortal** and select other function (see left column).

Or:

TV AUDIO

Press **TV** or **AUDIO** button for changing to TV or radio mode <sup>(1)</sup>.

Oder:

END

Press **END** button in the MediaPortal main level to change to the last active operating mode (TV, radio).

## Media menu

The Media menu is used for making settings to your network adapter and to the various types of media (photo, music, video).

⇒ **MediaPortal** is open.

MENU

**MENU:** Call / close **Media menu**.

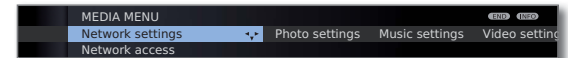

◀ ▶ Select desired menu item,  
▼ go to the menu line below.

◀ ▶ Select the desired setting,  
**OK** call.

**Network settings:** see below.

**Photo settings:** see page 60.

**Music settings:** see page 60.

**Video settings:** see page 60.

**DivX(R) settings:** see page 60.

### Explanation of the setting possibilities in Network settings menu

**Network** You can activate or deactivate the network settings of access your TV set here.



◀ ▶ Select **Network access**,  
▼ go to the menu line below.

◀ ▶ Select the type of access required.

**off** deactivates all existing network adapters of your TV set.

**On, wired:** Access to the network only via a network cable. The wireless access is deactivated.

**On, wireless:** You can connect the TV set to your home network via wireless radio connection by using the WLAN USB stick that is available as an accessory. The access via a network cable is deactivated.



**OK** Adopt access type or change **Current settings** for the adapter.

<sup>(1)</sup> The AUDIO key can be assigned another function (see page 95).

## Configuration of the built-in LAN adapter

You will see an overview of the current settings for the selected network adapter (for an explanation of the points, see page 59).

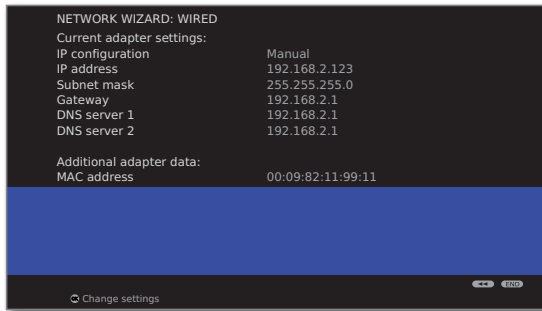

**OK Change settings** for the network adapter.



◀ ▶ Select type of **IP configuration**.

**Manual:** Enter your fixed static IP address manually (see below).

**Automatic:** Automatic configuration of the IP address via DHCP server or via multiple protocols according to UPnP specification (including DHCP).



**OK Proceed.**

If **manual** has been selected under **IP configuration**:

▲ ▼ Enter IP, Subnet mask, Gateway and DNS server addresses in succession with the numeric keys on the remote control.

**OK Proceed.**

You will now see an updated overview of the settings for the network adapter.



**OK End of wizard.**

## Configuration of a wireless adapter (e.g. WLAN bridge adapter)<sup>1)</sup>

You will see an overview of the current settings of the network adapter (see left column).



**OK Change settings** for the network adapter.

The TV set now searches for wireless routers.



**Red button: Stop search.**

After the end of the search:



▲ ▼ Select required base station from the options found.  
**OK Proceed.**

If the desired access point is not found:



**Red button: Repeat the search.** Or:



**Yellow button: Specify base station manually**, e.g. if the SSID of the access point is not transferred. Same procedure as for **Rename station**, see page 43.

If your wireless network has an encryption:



**Numeric buttons:** Enter WLAN password (procedure same as **Rename stations**, see page 43).



**Green button:** Switch from lower case to capital letters and vice versa.



◀ Delete last character.

➡ Contact your network administrator if you do not know the WLAN code.

➡ For encryption types supported, see page 104.

For WEP encryption:



▲ ▼ Select the **WEP index**,  
**OK Proceed.**



◀ ▶ Select type of **IP configuration** (see left column).

You will now see an updated overview of the settings for the network adapter.



**OK End of wizard.**

<sup>1)</sup> The WLAN USB stick is available as an accessory (see page 105).

## Explanation of the adapter settings

IP The current assignment method for the IP address of configuration your TV set.

IP address Your current IP address.

Subnet mask Your current subnet-mask IP address.

Gateway (only for **IP configuration → manual**)  
Your manually set gateway IP address.

DNS server 1 (only for **IP configuration → manual**)  
Your manually set first DNS server IP address.

DNS server 2 (only for **IP configuration → manual**)  
Your manually set second DNS server IP address.

Network SSID The name of your network.

MAC address Indicates the MAC address that is built into the hardware of your TV set's wired network adapter (LAN).

Link status Gives you information about the current status of your wireless connection (save settings, connecting, login failed, access point not found, not connected, connection established).

Link quality Specifies the signal strength as a percentage.

## Explanation of the setting possibilities in the Photo settings menu

► The menu can only be opened when a photo is displayed (see page 65).

Go to ... Skip to a definite picture or to the start/end of the current folder.

Picture display Display pictures in optimal size or in original resolution.

Picture change Select how long each picture is to be shown during a slideshow

Photo info Select **on** to have the photo information (file name and selection of the files in the folder) permanently showing when in full-screen display or slideshow mode.

Rotate photos Photos in portrait format can be automatically displayed automatically vertically (with corresponding Exif entry).

Picture settings You can carry out the picture settings for the photo display here. The settings correspond to the picture settings in TV mode (see page 35).

## Explanation of the setting possibilities in the Music settings menu

► The menu can only be opened when the Music Player is displayed (see page 64).

Auto return to music player The music player will reappear whenever the music list is opened during playback (see page 64) and no other buttons are pressed for the duration of the specified time period.

Sound settings You can carry out the audio settings for playing music here. The settings correspond to the audio settings in TV mode (see page 33).

## Explanation of the setting possibilities in the Video settings menu

► The menu can only be opened when the Video Player is displayed (see page 66).

Picture settings You can make the picture settings for playing videos here. The settings correspond to the picture settings in TV mode (see page 35).

Subtitle Language You can carry out the audio settings for playing videos here. The settings correspond to the audio settings in TV mode (see page 33).

## Explanation of the setting possibilities in the DivX(R) settings menu

To use DivX VoD (Video On Demand), you must register your TV set with DivX. To do so, visit the DivX website at

**<http://www.divx.com/en/movies/register-your-device>**.

Follow the individual steps under **How to Register**. You require the registration code specific to the set.

Registration code Here you will receive a registration code for use by DivX VoD. Enter the registration code on your PC when registering your TV set.

Deactivation code This is where you receive a code to terminate registration of the TV set.

► It will no longer be possible to use DivX VoD after cancellation of the registration.

## MediaHome

**MediaHome** includes both storage media directly connected to the TV set (e.g. USB sticks) as well as data provided in your home network (e.g. from a media server on a PC or a network hard drive).

➡ **MediaPortal** is open.

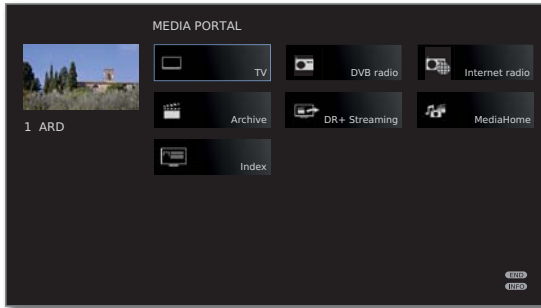

◀ ▶ ▲ ▼ Mark **MediaHome**,  
**OK** activate.

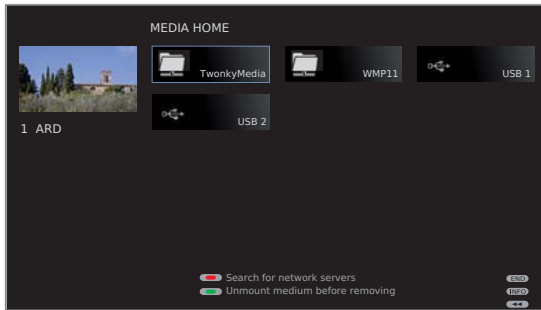

◀ ▶ ▲ ▼ Mark desired media source.  
**OK** Open highlighted media source. The available content of the media source is displayed.  
➡ The media sources shown here depend on the devices available/used.

**MediaCenter** A Loewe MediaCenter connected to your home network.

**TwonkyMedia** Examples with media servers in your home network. The exact designation depends on the media server used.

**USB** USB storage media on the USB connections of your TV set. The exact designation depends on the relevant storage medium.

➡ Please also observe the notes on page 97 regarding USB sticks!

### Unmounting USB storage media

You should unmount USB storage media properly after use before removing them from the TV set. This avoids a loss of data.

➡ A USB storage medium is marked in **MediaHome**.

 **Green button:** Unmount USB storage medium before removing it.

➡ Once unmounted, the USB storage medium cannot be used again until it is reinserted!

# Media+

## General navigation in the media overview

► The graphics on this page typically show a single-column list view. You can switch between the views as required (see page 63).



▲ ▼ Select desired folder.

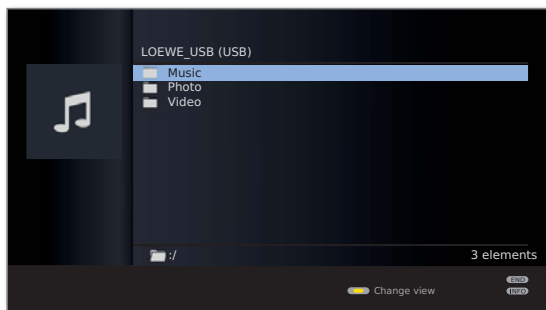

- ▶ Open marked folder. The content of the folder opened will be displayed.
- ◀ Go back a folder level if necessary.



◀ ▶ ▲ ▼ Repeat procedure if necessary.

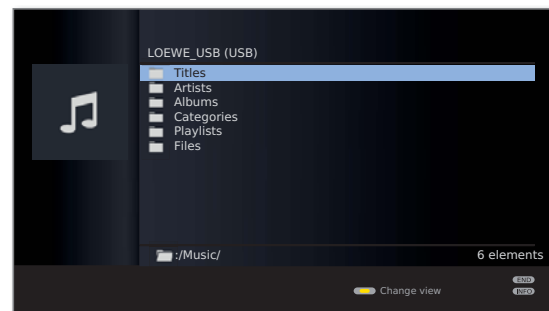

▲ ▼ Select media file (example below: music title).  
OK Play/display selected media file.

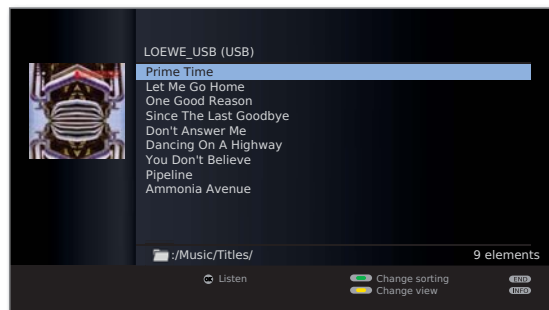

Playing music: see **MediaMusic**, page 64.



Displaying photos: see **MediaPhoto**, page 65.

Playing videos: see **MediaVideo**, page 66.

## Change view

You can change the view of the displayed files and folders.

In the Media overview:

-  **Yellow button:** Open **Change View**, and:
-  **Yellow button:** Switch over to single-column list view (see sample figures on page 62).
-  **Blue button:** Switch over to thumbnail view.



Thumbnails - example with photo overview

## Playing/displaying data from USB storage media

If a USB storage medium is selected as a source (see page 61), the following special features apply for actions and the media overview:

- The uppermost folder level is divided into three fixed categories:
  - Music** with the subfolders **Titles**, **Artists**, **Albums**, **Categories**, **Playlists**, **Files** (see below).
  - Photo**
  - Video**
- The original folder structure of the USB storage medium is retained in the media overview for **Photo** and **Video**. For playing **Music**, the available titles are prepared and offered in the above subfolders.

### Subfolders in Music mode

- Titles:** The music titles found on the USB storage medium are sorted by title name.
- Artists:** The music titles found on the USB storage medium are sorted by the respective artist.
- Albums:** The music titles found on the USB storage medium are sorted by album name.
- Categories:** The music titles found on the USB storage medium are sorted by their respective musical categories (e.g. Jazz, Classical, Pop, Rock) and displayed correspondingly.
- Playlists:** Display and play back any play lists that have been generated on the PC.
- Files:** The music titles found on the USB storage medium will be shown without being especially sorted (in order of file name).

## Playing files from the home network

When using a media server in your home network as a source (see page 61), the names of the folders displayed are specified by the media server.

For further operation, see **General navigation in the media overview** on page 62.

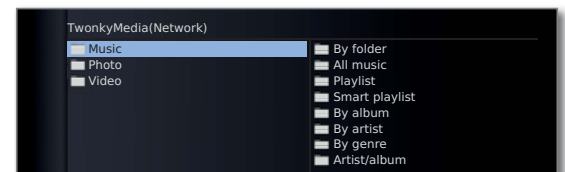

Example: Overview of a media server with the name **Twnoky Media**

## MediaMusic

→ A music title is highlighted in the media overview.

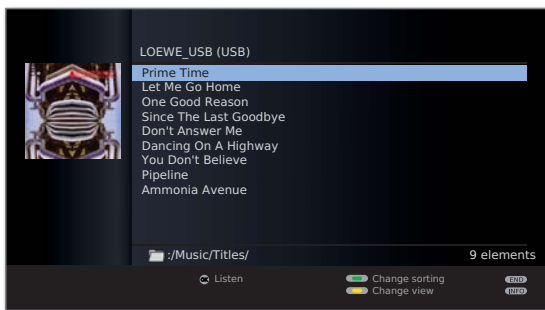

OK Play highlighted music title (see right column).

## Play music files

→ A music title is highlighted.



OK Play music title.

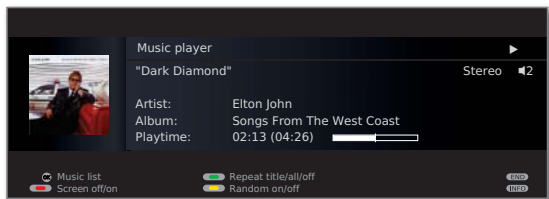

**PAUSE button:** Pause/resume current playback.



**PLAY button:** If playback is paused:  
Continue paused playback.  
For playback in progress:  
Play title from the beginning.



short: Playback previous/next title.  
long: Rewind/fast forward.



OK Return to the music list without ending the current playback



**STOP button:** End playback and return to overview.

## Explanation of the symbols in the playback window

The symbols at the top right show you information about the current playback.

- ▶ Playback
- || Pause
- ◀◀ Rewind
- ▶▶ Fast-forward
- ↺ Replay current title
- ↻ Replay all titles in the current folder
- Random play activated

The bar behind the **playtime** shows you how far the music file has been played.

## Function of coloured buttons during music playback



**Red button:** Switch **screen off/on**.



**Green button:** **Repeat** individual **title/all** titles/  
Repeat **off**.



**Yellow button:** For music files from local media  
**Random** play of files in currently selected folder **on/off**.

For Internet radio:  
Switch to the last radio station that was listened to.



## MediaPhoto

➡ A picture is selected in the media overview.

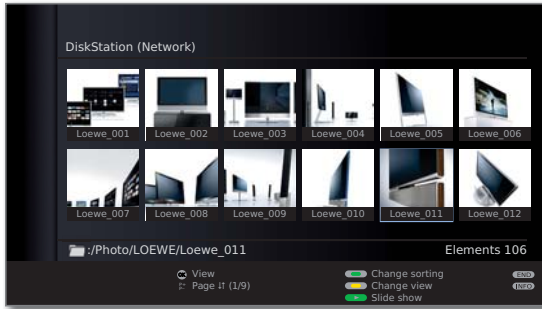

**OK** View marked picture in full screen mode (see below).



**PLAY button:** Start slideshow (see right column).

### Full-screen mode

➡ A picture has been selected.



**OK** Opens full picture mode.

➡ Portrait photos (with the corresponding entry in the Exif files) are automatically positioned correctly for viewing.



Show previous/next picture.



▲ ▼ Rotate picture by 90 degrees to the left/right.

**OK** Quit full-screen mode and return to overview.

### Slide show



**PLAY button:** Start slide show.

- ➡ from photo overview: Start slide show with marked picture.
- ➡ in full screen mode: Start slide show with displayed picture.



**PAUSE button:** Pause slide show.



**PLAY button:** Continue slide show.



**STOP button:** End slide show and return to overview.

## MediaVideo

➡ A video is selected in the media overview.

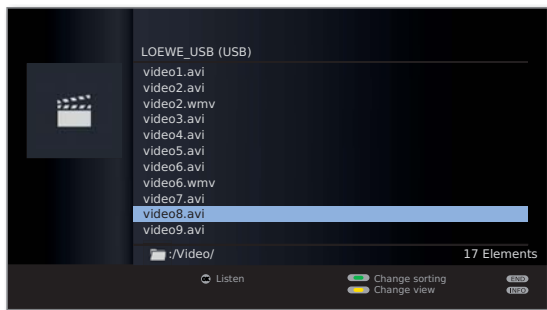

OK Play highlighted video.

### Information on high-resolution films in general

Due to technical limitations (e.g. interference, limited bandwidth), interruptions to playback up to and including complete termination of the playback may occur when playing high definition film material (HD films) on 720p format or above (1280 x 720 resolution or above).

### Information on high-resolution films via wireless connection <sup>(1)</sup>

High definition film material (HD films) from format 720p upwards (resolution 1280 x 720 or higher) should be played back via a **wired** connection. If there is a **wireless** connection, then technical limitations (e.g. fault liability, bandwidth limitations) can cause disruptions in the playback right up to a complete breakdown of the playback.

<sup>(1)</sup> The WLAN USB stick is available as an accessory (see page 105).

## Playback

➡ A video is selected.



OK Play highlighted video.



**PAUSE button:** Pause current playback.



**PLAY button:** Continue paused playback.



**STOP button:** Stop current playback and return to overview.

## Video status bar

The video status bar provides you with further information about the current playback.



**INFO:** Display/hide status bar/file information/context information.

Pressing the **INFO button** the first time will show the video status bar. Pressing a second time shows the file information for the video. Pressing the **INFO button** again shows the context information with operating instructions. When you next press the **INFO button**, all on-screen displays except the status display will be closed again.

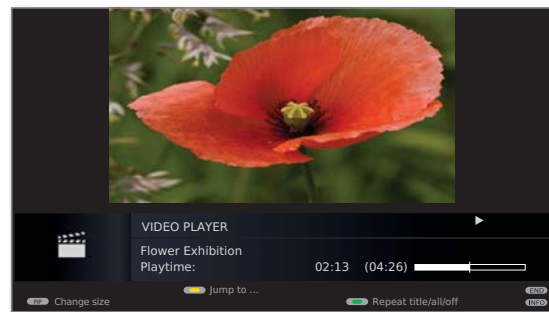

**END:** Close displayed content.

## Explanation of status bar symbols

The symbols (in the status bar top right) show you information about the current playback.

- ▶ Playback
- || Pause
- ◀◀ Rewind (speed 2x, 4x)
- ▶▶ Fast-forward (speed 2x, 4x)
- 🔄 Replay current title
- 🔄🔄 Replay all titles in the current folder

The bar behind the **playtime** shows you how far the video has been played.

# Media+

## Wind

You can fast-forward/rewind videos to search for desired scenes.



Rewind at double speed.  
Speed 2x, 4x.



Fast-forward at double speed.  
Speed 2x, 4x.



**PLAY button:** Continue playback.  
Please wait until the videos have loaded into the device.  
This can take a few seconds, depending on the bit rate of the film.

## Jumping

You can jump to any point in the video by entering a time.



**Yellow button:** Open **Jump to .....**

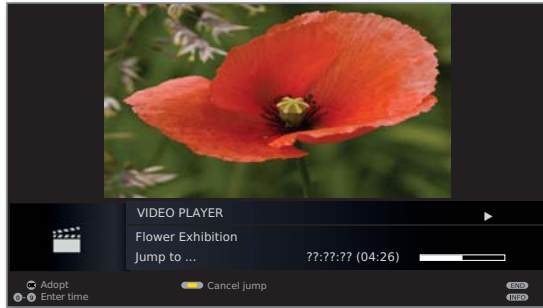

Enter the desired time with the **numeric buttons**.



**OK** Jump to the time entered.



**Yellow button:** Cancel the jump.

## Play back videos repeatedly



**Green button:** **Repeat individual title/all titles/Repeat off.**

## Select language/sound

Video files can contain several audio tracks.

The language/sound selection is only available with DivX videos via USB.



**Red button:** Select **Language/sound**.

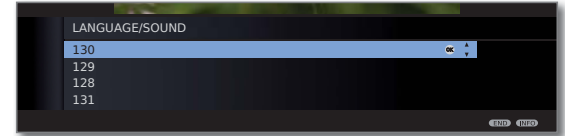

▲ ▼ Highlight the desired sound or language and **OK** selects the audio track.



**END:** Cancel audio track selection.

## Change size



**PIP:** Change the **size** of the video window.

You can choose between small or full image settings.

Small image setting shows the video close to the original resolution. The video status bar is permanently shown below the image.

The full image setting enlarges the image to fit the entire screen. The status bar can be set to visible or hidden (see page 66).

## Subtitles

Subtitles are only available with DivX videos via USB.

The played back DivX video contains subtitles.



**Blue button:** Call subtitle selection.



▲ ▼ Select the desired subtitles,  
**OK** Call up subtitle.

The subtitles are only shown during full screen display.

## Subtitle time correction

If subtitles appear displaced against the video and audio, this can be adjusted by using the subtitle time correction.



**TEXT:** Call **Subtitle time correction**.



◀ ▶ Adjust time correction.  
**OK** Accept time correction

or



**END:** Cancel time correction.

# Interactive data services

## HbbTV / MediaText

HbbTV (Hybrid broadcast broadband television) offers the user extensive multimedia content, e.g. media libraries or additional information on the programme that is currently playing (if these are available from the current channel).





**MediaText** helps you to use the next generation of teletext/videotext for HbbTV.

- ➡ The TV must be connected to the Internet to use HbbTV/MediaText. A connection speed of at least 6,000 kbit/s (DSL 6000 or equivalent) is recommended for smooth playback of videos.

### Open HbbTV application

If an HbbTV application is available for the chosen channel after changing channels, this will be loaded and a red button symbol will appear.

- ➡ HbbTV is offered by the selected channel.
- ➡ Connection to the Internet.
- ➡ HbbTV mode is set to **on**.

    **Red button:** Load / display HbbTV application.



The appearance, key assignment and available functions of the HbbTV applications are dependent on the provider. Under certain circumstances, the recording and bookmarking functions of the applications may not be supported.

Loewe takes no responsibility for the accessibility, functionality or content of HbbTV applications.

### Hide / close HbbTV application



**END:** Hide HbbTV application.

The HbbTV application will disappear.

### HbbTV mode on/off

When the HbbTV mode is active (factory setting), additional services and further information (e.g. also from the Internet) can be viewed if these are offered by the current station.



**MENU:** Call TV menu.



- ◀ ▶ Select **Settings**,  
▼ go to the menu line below.

- ◀ ▶ Select **Miscellaneous**,  
▼ go to the menu line below.

- ◀ ▶ Select **HbbTV mode**,  
▼ go to the menu line below.

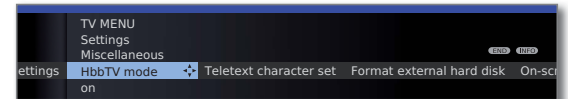

- ◀ ▶ Set the changes.

- ➡ If the setting **HbbTV mode** → **off** has been selected, you can open the archive by pressing the red button.

# Digital Recorder

## About the Digital Recorder system

You can use the Digital Recorder of your Loewe TV set to record programmes onto an external storage device connected via USB.

The Digital Recorder can also process HDTV signals including the audio and auxiliary signals that they contain.

The various ways in which your Digital Recorder can be used are listed below.

### Overview of functions

Digital Recorder function	
Archive recording onto an external USB storage device	●
Archive recording of analogue stations	–
Archive recording of digital stations (DVB-C/-T/-S)	●
Archive playback from USB storage devices	●
Time shift TV in live play mode	●
Time shift TV when archive recording is running	–
DR+ Streaming	●
Follow me function	–

● available

– not available

# Digital Recorder

## Digital Recorder archive

You can record movies you want to watch later in the Digital Recorder's archive.

- ➡ Recording of analogue stations is not possible.
- ➡ Recordings of CI Plus encoded programmes are perhaps not possible or only to a limited extent (see page 85).

If EPG data is available, the Digital Recorder saves the title and additional accompanying information for each programme into the archive.

If additional languages are being transmitted for a DVB broadcast, these are also recorded. You can display the language choice in the same manner as when the set is in TV mode.

Start playback of your recordings from the archive.

You can easily choose whichever programmes you would like to be recorded from the EPG and watch them later from the Digital Recorder archive.

- **Sort titles**  
You can have the broadcasts displayed according to time or alphabetically. You can therefore quickly find the recording you want to watch.
- **Rename/edit titles**  
You can change the title of a programme in the archive, if necessary.
- **Parental lock**  
Protect your archive against unauthorised access by using the parental lock feature.

## TV viewing with time shift

You can play back the programme that you are currently watching in time shift mode.

- ➡ Time-shifted operation is perhaps not possible or only to a limited extent for programmes of stations working with CI Plus encoding (see page 85).
- **Time shift**  
When you are watching a TV programme, you can pause it at any time and then use time shift TV to watch it later.
- **Fast navigation by jumping**  
You can wind and rewind during a film at just the press of a button. The jump distance is adjustable.  
The **Smart Jump** function also ensures that the jump width is halved each time the jump direction is changed or doubled after three jumps in the same direction (max. 16 minutes). This way you can quickly find a certain spot of the recording.
- **Fast forward and rewind**  
You can fast forward and rewind at three different speeds in the programme you are viewing with time shift.

# Digital Recorder

## Archive recording

➡ To record encoded programmes, please also read the instructions on pages 84 and 85.

➡ Recording of analogue stations is not possible.

You can play back a pre-recorded programme from the archive whilst another TV programme is being recorded into the archive.

➡ If several USB storage devices are connected, the first device recognised will be used for the recording. If storage devices are plugged into both the TV set's USB ports at the same time, the storage device plugged into the side port will be used for recording. If several storage devices are connected to the TV set at the same time, ensure that the one you want to use for the recording is plugged into the side USB port.

### • Immediate recording

Record interesting programmes directly into the archive with the **RECORD button**. The programme is recorded from the point at which the recording function is selected to its end or to the end of the set recording time.

### • Timer-controlled recording

Comfortably select your favourite programme for recording, from the EPG or teletext. The timer overview has room for 50 entries. Watch the programmes later from the Digital Recorder's archive.

## Archive playback

All the recorded programmes can be selected in the archive and played. During archive playback, another programme can be recorded into the archive.

### • Fast forward and rewind

There are three different speeds for winding and rewinding films.

### • Fast navigation by jumping

You can fast forward and rewind during a film at the touch of a button. The jump width is adjustable (see page 72).

The **Smart Jump** function also ensures that the jump width is halved each time the jump direction is changed or doubled after three jumps in the same direction (max. 8 minutes). This way you can quickly find a certain spot of the recording.

## Technical information

The TV set uses the hard disk file system FAT32. The file system NTFS is not supported. PCs with the operating system Microsoft Windows only support a total hard disk volume of 32GB when formatting on FAT32. Larger hard disks are automatically reduced in their capacity by this. Format external USB disks that you wish to use with the TV set via the **TV menu → Settings → Miscellaneous → Format external hard disk** (see page 84), so as to be able to utilise the hard disc capacity.

Switching off the TV set with the mains switch during operation or an inadvertent disruption to the power supply (e.g. power failure) can cause damage to the hard disc file system and hence loss of the recorded broadcasts. Always first switch your TV set to standby mode (press On/Off button on the remote control or switch-off button in the middle of the operating eye on the TV set), before switching off at the mains switch. Do not disconnect the external hard drive from the TV set during recording under any circumstances.

However, if unexpected problems occur when operating the hard disc, formatting the hard disc may rectify this. Refer to the instructions on page 84.

# Digital Recorder

## Settings

You can make a few settings in the **Archive menu** to adapt the Digital Recorder to your requirements.

### Call Archive menu



Call **Archive**.



**MENU:** Call Archive menu.

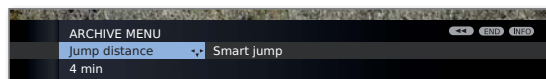

- ◀ ▶ Choose a setting,
- ▼ switch to the menu line below.



- ◀ ▶ Set or enter using the **numeric buttons** of the remote control.

### Explanation of the setting facilities

- Jump distance** Set the standard jump width used for jumping forwards or backwards in the film by pressing ◀◀ or ▶▶.  
Factory setting: **4 min**.
- Smart Jump** Activate or deactivate Smart Jump function (see page 78).  
Factory setting: **on**.



# Digital Recorder

## Setting the pre-record and post-record time

For timer recordings, a lead and follow-up time can be set. This minimises the risk of a part of the broadcast not being recorded due to the broadcast starting earlier and/or finishing later.

MENU

**MENU:** Call TV menu.



- ◀ ▶ Choose **Recording**,
- ▼ switch to the menu line below.

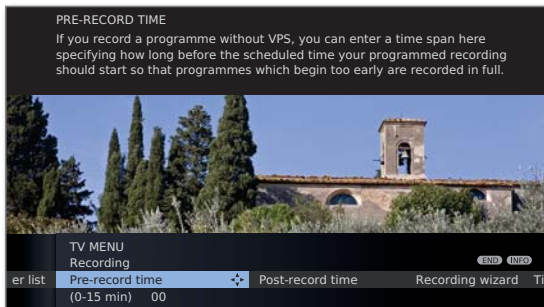

- ◀ ▶ Set **pre-record** or **post-record time**,
- ▼ switch to the menu line below.



Enter the time using the **numeric buttons** (always 2-digit: 01 to 15 mins for pre-record time; 01 to 60 mins for post-record time). Factory setting: pre-record: **00 min**, post-record: **00 min**.

## Archive recording – Direct recording

► For recording encrypted broadcasts, please also refer to the information on pages 84 and 85.



Press **RECORD button** briefly: Start direct recording. The **Recording duration** selection is called.

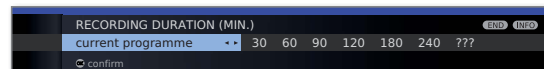

- ◀ ▶ Select desired recording time.

**current programme:** The broadcast being watched is adopted in the archive.

**???** : Manually enter the recording duration with the numeric buttons of the remote control.



**OK** Confirm. Call **Timer data**.

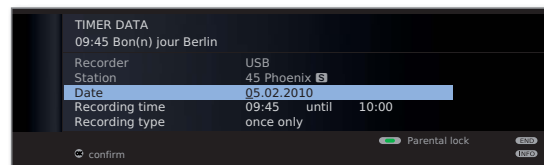

Check the timer data, change if necessary and confirm with **OK**. The recording is started.

See page 76 for explanations of the setting options in the **Timer data** menu.

# Digital Recorder

## Viewing another movie from the archive during archive recording

After you have started the recording, you can also watch a programme you have already recorded.



Call **Archive**.



▲ ▼ Select recording,  
**OK** view film.

- ▶ If an encrypted programme is recorded with the option **Descrambled recording** → **yes**, the CA module required for decoding is used for the recording. In this case you cannot watch any other encrypted programme from the archive.

## Switching off the TV set during recording

You can switch off the TV to standby whilst recording. The recording is continued in the standby mode. The display on the set shows orange.

- ▶ **Never** switch the TV set off at the mains and do **not** pull out the plug of the TV set out of the socket. Otherwise the recording will be lost!

## Subtitles

Any subtitles that are transmitted can also be recorded (see page 76).

Display recorded subtitles during later playback:



**INFO:** Show status display (see right column)



**TEXT:** Call subtitle selection.



▲ ▼ Select desired subtitles.  
**OK** Show subtitles.

## Stop recording early

You can end a current archive recording prematurely.



Press **STOP** button.



**OK** Stop recording.

The recording is stopped. Whatever has already been recorded is saved onto the USB storage device and can then be played back over the archive.

You can also end a running recording by deleting the entry in the timer overview or in the archive. See page 77 for further information.

## Status display when watching in time shift mode and when recording onto the archive



**INFO:** Show status display.

Display with time shift playback:

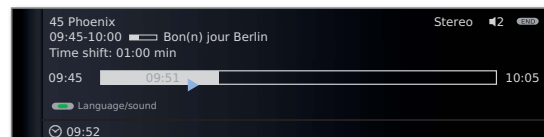

Display with live picture during an archive recording:

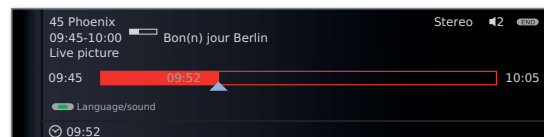

# Digital Recorder

## Archive recording – Timer recording

➡ For recording encrypted broadcasts, please also refer to the information on pages 84 and 85.

You can programme timer recordings for the Digital Recorder conveniently using the EPG or manually. Up to 50 simultaneous timer entries are possible.

When you have programmed timer recordings, the TV set can only be switched off to the standby mode. **Never** switch the TV set off at the mains and do **not** pull out the plug of the TV set out of the socket. Otherwise no timer recordings can be made!

Programmed timers for the Digital Recorder are displayed in the timer overview.

For an explanation of the symbols in the timer list see the chapter **Timer list** on page 77.

 Call **Archive**.

 **Red button:** Call **Timer list**.



A red dot with a key symbol appears in front of the entry for scrambled recordings still to be descrambled.

## Programming a timer recording with the EPG

 Call **EPG**.

 Flag the broadcast to be recorded.



 **RECORD button:** Programme the recording of a broadcast. Timer data dialogue is opened.

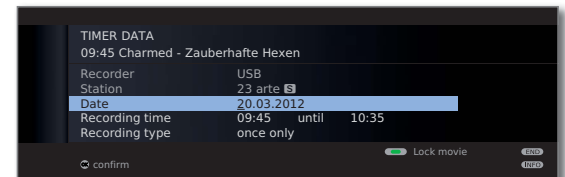

 Check the timer data and change it if necessary.

**OK Confirm** timer data. The broadcast is entered into the timer overview.

See page 76 for explanations of the setting options in the **Timer data** menu.

In the EPG a red dot is set in front of the title of the programme. If a broadcast is already marked with a red dot, you can re-delete the programmed timer entry using the **RECORD button**. The red dot and the entry in the timer overview disappear.

# Digital Recorder

## Programming a timer recording manually



**MENU:** Call TV menu.



- ◀ ▶ Select **Recording**.
  - ▼ go to the menu line below.
- ◀ ▶ Select **Recording wizard**.
  - ▼ go to the menu line below.



- ◀ ▶ Select **Manual**.
  - OK** Start programming.



- ▲ ▼ ◀ ▶ Select the station or connection socket to be recorded.

**OK** Accept.

The **Timer Data** menu is displayed.

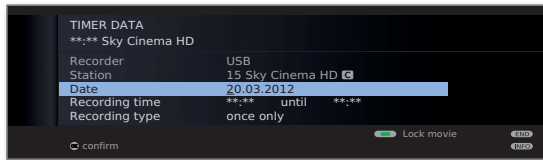

Check the timer data. Enter the date and recording time in any case.

**OK** Confirm. The broadcast is entered into the timer overview.

## Explanations of the setting options in the Timer data menu

- Station** (only available when the selected station can be received via different signal sources, e.g. DVB-T and DVB-S)  
Select the signal source for the recording.
- Date** Date of recording.
- Recording time** Time of the recording.
- Programme provider PIN** (only for recording CI Plus protected broadcasts)  
Enter the CA module's parental-lock PIN. Refer also to page 85.
- Recording type** Select **once only**, **daily** or **weekly**.
- Record subtitles** Select whether broadcast subtitles are to be recorded too.
- Lock movie** Only allow later playback of this recording after entering the PIN number (child lock). Press **green button**.

# Digital Recorder

## Delete programmed timer entries

Use this function in the timer overview if you want to delete recordings already programmed or end a running timer recording.



Call Archive.



**Red button:** Call Timer list.



▲ ▼ Mark the timer to be deleted.

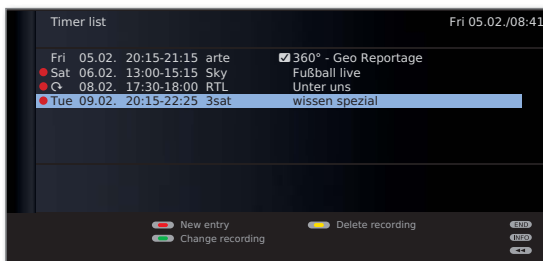

**Yellow button or blue button:** Delete timer entry.

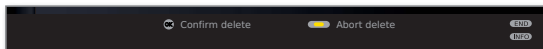

**OK** Confirm.

➡ The letters of a timer currently active are red. If you delete this timer, the recording is stopped.

## Timer list

All programmed recordings and earmarked programmes are listed in the timer list.

Using the timer overview, you can programme new recordings and earmark other programmes.



Call Archive.



**Red button:** Call Timer list.

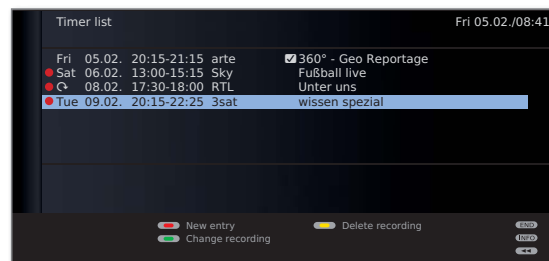

**Red button:** New entry.

**Green button:** Change recording.

**Yellow button:** Delete recording.

**Blue button:** Delete memo.

### Explanation of the symbols in the timer list:

- Record
- 🔄 Repeated recording (daily or weekly)
- ☑ Marked programme (see page 45)

# Digital Recorder

## TV viewing with time shift

You can play back the programme that you are currently watching in time shift mode.

➔ Please also read the instructions on watching time-shifted television on page 70.

### Interrupt



Press **PAUSE button**.

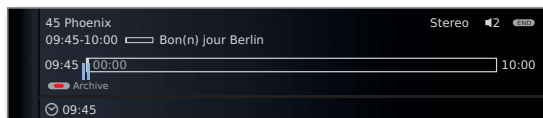

The TV image becomes a freeze frame and the DR status display appears.

At the top you will see the number and name of the station if EPG or teletext data are available, in addition to the start and end of the current programme and the title of the programme.

On the left hand side of the bar you can see the start time for time shift recording. On the right hand side of the bar you can see the time at which the time shift recorder will be full (automatically extends by 30 minutes, up to a max. 3 hours). The bar shows the amount of available recording capacity already used.

### Continue (time shift viewing)



Press **PLAY button**.

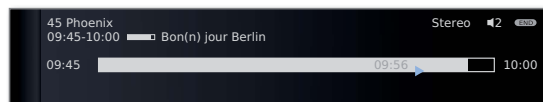

You can now watch the TV programme with a time shift from the time you pressed the **PAUSE button**. The Playback symbol ► appears in place of the Pause symbol II .

### Switch to live picture



Press **STOP button**.

You see the station's live picture again.

### Jumping

You can jump during time shift viewing by briefly pressing the buttons ◀ ▶ in the jump distance set; this enables you to skip uninteresting sections quickly.



▶▶ Jump forwards.

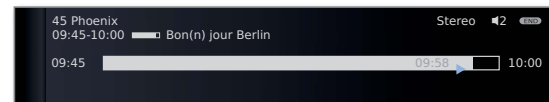

◀◀ Jump backwards.

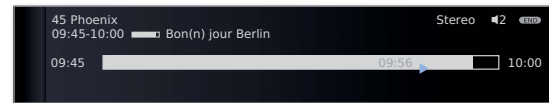

### Smart Jump

If Smart Jump is activated, the jump width is halved every time you change the jump direction. The jump width is doubled if you jump more than three times in the same direction (max. 8 min.).

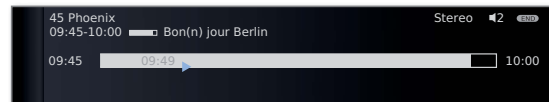



# Digital Recorder

## Fast forward and rewind

During time shift viewing you can fast forward and rewind at three different speeds. Sound is not audible during winding.

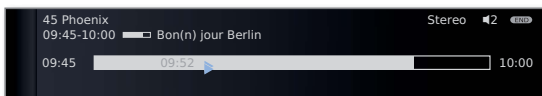
  Press  or  for a little longer.



By briefly pressing  or , the speed will increase until you switch back to the first speed.

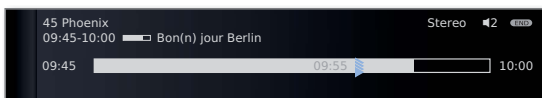

If the end of a recording is reached when fast-forwarding, the display will automatically switch to the live TV picture. When rewinding to the beginning of a time delay, playback will begin at the beginning of the time-delayed recording.

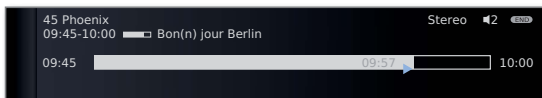

# Digital Recorder

## Archive playback



Call **Archive**.

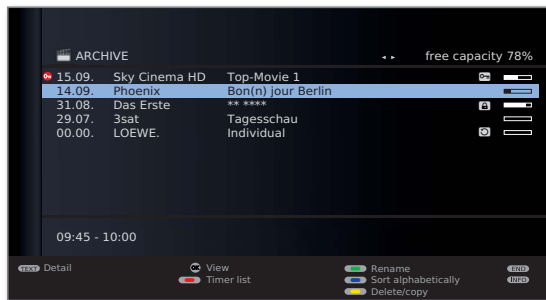

The remaining **free capacity** on the storage device is shown at the top right-hand corner.

▣ The free capacity indicated is an estimated value. The exact remaining capacity of the storage device depends on the programmes to be recorded in future.

The progress bar shows you how much of the recording has been watched.

If other programme data is available from EPG or teletext these are shown below the archive list for the entry just flagged. Other information about the recording can be called with the **TEXT button**, if this is offered.



**Blue button:** Sort recordings **chronologically** or **alphabetically**.

### Explanations of the symbols in the archive

- Archive entry with active replay (page 81).
- Archive entry with set parental lock (page 76).
- Coded archive entry.
- CI Plus coded archive entry.

## Playing from the archive



▲ ▼ Select the recording.  
**OK** Start playback.

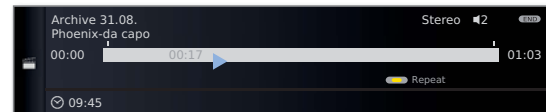

▣ The CA module with Smart Card must be plugged in when playing recordings which are still coded.



# Digital Recorder

➡ When playing coded recordings, some of the following functions might only be possible with limitations.

## Jumping

By pressing **button** ◀◀ or ▶▶ you can skip through the broadcast.



▶▶ Jump forwards.

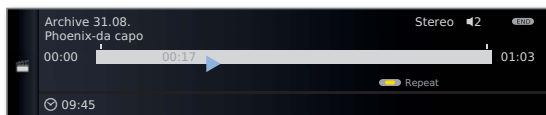

◀◀ Jump backwards.



➡ Setting the jump distance: see page 72.

## Smart Jump

Smart Jump allows you to search quickly for certain scenes of a recording. You will find more about this on page 78.

## Fast forward and rewind

During time shift viewing you can fast forward and rewind at three different speeds. Sound is not audible during winding. You will find more about this on page 79.

## Pause (freeze picture)



**PAUSE button:** Switch to freeze picture.



**PLAY button:** Continue playback.

## Repeat playback of recording

You can repeat recorded broadcasts and hence play them in an infinite loop.



**INFO:** Show status display.



**Yellow button:** Repeat film.

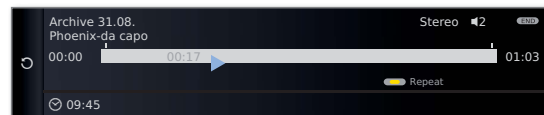

You will see a circular arrow on the left of the status display and in the archive after the name of the broadcast (see page 80). The function remains set for this broadcast even if the playback is interrupted.



**Yellow button:** Switch off repeat function again.

## Deleting recordings from the archive

➡ Archive is displayed.



▼ ▲ Flag the recording to be deleted.



**Yellow button:** Call Delete.

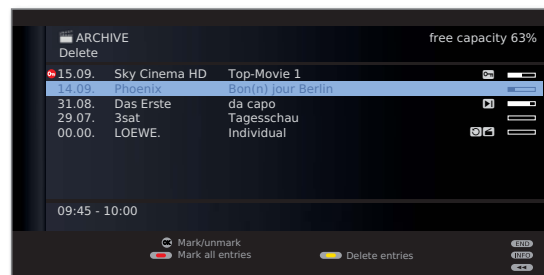

▼ ▲ Select others if necessary and **OK** confirm.



**Red button:** Mark all entries.

➡ Titles to be deleted are displayed in blue.



**Yellow button:** Call Delete entry.



**OK** Confirm delete.  
The recording(s) is/are deleted.

The archive is displayed again.

# Digital Recorder

## Changing the title of an archive

english



- ➡ Archive is displayed.
- ▼ ▲ Select the title to be changed.



**Green button:** Call Rename.

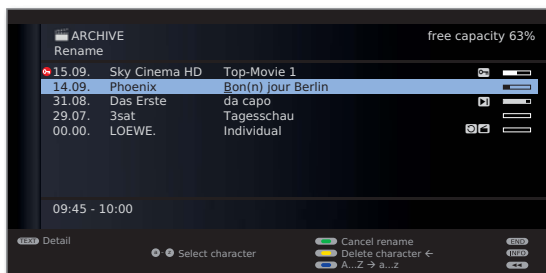

You will see a line showing the current insertion position under the first letter of the title.



- ▶ Input position to the right.
- ◀ Input position to the left.



Input the characters one after another (if entering using the number buttons on the remote control, use it as if they were a telephone keypad; see page 98 for the exact assignment of the buttons).



**Yellow button:** Delete character to the left of the cursor.



**Green button:** Switch between capital letters and small letters.



**OK** Conclude the entry.  
This saves the change permanently.

## Viewing a locked movie



Call **Archive**.

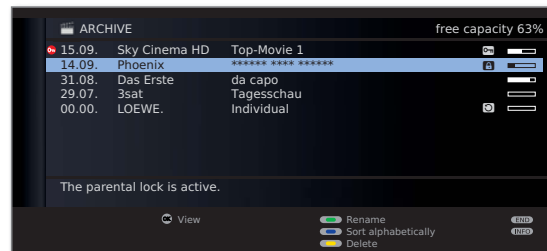

▼ ▲ Mark locked film,  
**OK View** film.

➡ The titles of locked films cannot be read. The detailed information for the recording cannot be called up. The entry receives the symbol at the end of the line.

The system requests you to enter your access code (PIN). After entering the access code the playback of the movie starts.

# Digital Recorder

## DR+ Streaming

You can view DR archive entries enabled by Loewe TV sets in your network via this function on your TV set.

- ➡ To use DR+ Streaming, at least two Loewe TV sets are required (at least one of which has DR+ integrated). The TV sets also need to be connected via a wireless connection (WLAN) or a cable connection (e.g. Ethernet, PowerLine).
- ➡ The enable for recorded programmes must be activated in the **DR+ Streaming settings** on the TV set with integrated hard disc (DR+).
- ➡ Archive entries can only be hosted or enabled by TV sets **with** chassis SL1xx with an integrated hard disc (DR+). Playback of archive entries that have been enabled is possible on all TV sets with chassis MB180 in the network.
- ➡ Functions requiring write access on the device that enables the programme to be viewed (child protection, delete protection, renaming, deleting entry or bookmark, setting bookmark, deleting or hiding parts of the recording) are not available when viewing a DR archive over the network.

## Play archive entry via network

MEDIA

**MEDIA:** Call **MediaPortal**.

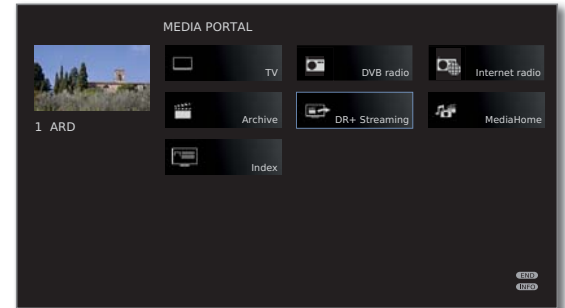

◀ ▶ ▲ ▼ Select **DR+ Streaming**,  
**OK** call.

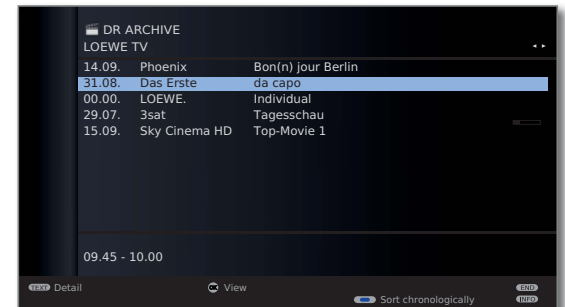

◀ ▶ Select required TV set.

The name of the accessible TV set is shown in the second line (in this example: **LOEWE TV**).

▼ ▲ Mark the required archive entry,  
**OK View** archive entry.

- ➡ With archive entries which are played back (streamed) via the network, it is not possible to select language/sound. You always hear the first audio track of the recorded transmission in each case. The **subtitle** selection is also **not** possible when playing back transmissions via the network for system reasons. The same also applies to the Follow me function.

See page 80 for further information.

# Digital Recorder

## Format storage media

Format USB storage media which you want to use with the TV set before first using **TV menu** → **Settings** → **Miscellaneous** → **Format external hard disk**.

A formatting might also provide a remedy in the event of problems when using your USB storage medium.

Additionally, you can re-format the hard disk in order to quickly and easily delete all the data stored on the storage medium.

### Warning!

Formatting the storage medium deletes all data stored on it!



Call **TV menu**.



- ◀ ▶ Select **Settings**,  
▼ switch to the menu line below.
- ◀ ▶ Select **Miscellaneous**,  
▼ switch to the menu line below.
- ◀ ▶ Select **Format external hard disk**,  
**OK** activate.

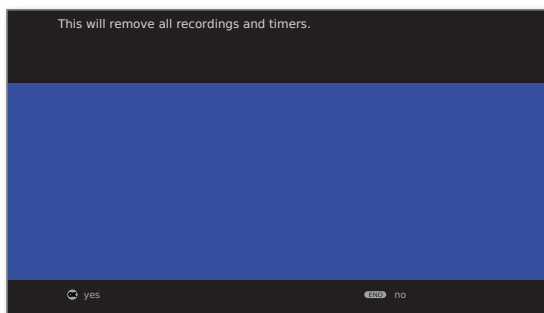

**OK** Start formatting.

- ➡ After the formatting, the TV set must be re-started.

Or:



**END**: Cancel the operation.

## DVB Common Interface standard (CI)

If a programme has been recorded coded, the decoding process is carried out automatically the next night in the standby mode (when timer data settings do not differ). Please note that the TV set may not be switched off at the mains overnight and that the CA module with SmartCard must be inserted in the CI slot of the TV set.

If the recording is not decoded fairly soon after decoding, it may not be possible to decode it at all. The longer the time between recording and decoding, the greater the probability that the code is no longer valid.

- ➡ The playback of encrypted programmes is strongly dependent on which CA module is used. The playback of encrypted recordings may sometimes not be possible, or only to a limited extent.  
Hint: When possible, record unencrypted programmes or unencrypt them as soon as possible.
- ➡ Selection possibilities in the CA module menu and performance capability of your CA module depend on the type of module used and the installed software. Consult the manufacturer of the module if you have any questions.

## DVB Common Interface Plus standard (CI Plus)

CI Plus is an advanced development of the DVB Common Interface Standard. CI Plus slots are in principle downward compatible to the previous CI standard, i.e. CA modules and Smart Cards according to the past CI standard can continue to be used in CI Plus slots, as far as the programme provider permits this.

The regulations of the past standards (see page 84) likewise apply to CI Plus. There are however further additional regulations.

Programme providers, who use the CI Plus standard, can assign different rights for their broadcast programmes. For instance, the programme provider can restrict or completely prevent recording or later watching of an encoded programme. If there are such regulations, these also apply to time-shifted watching of television programmes.

A screen message informs you of this fact, if you would like to record such a programme. Recording is carried out in such a case (an appropriate entry is displayed in the archive), later watching of the programme is however not possible at all or only for a limited period (e.g. 10 days). The provider can also prohibit later decoding of a recorded encoded programme.

➡ All restrictions mentioned here are the responsibilities of the broadcaster. The TV simply values the broadcaster set signalling as neutral.

It could be necessary to enter the parental protection PIN of the CA module when programming the data, if you want to record a CI Plus protected programme, which has been protected against viewing by minors. The secret number of the TV set is required for watching the programme later.

The appearance of the CA module menu of CI Plus can deviate from the normal appearance of the TV menu.

### Software update for CI Plus capable CA modules

Every now and then, there will be new system software for your CA module software. There are two software update types.

Recommended update:

Information on an available update is displayed. You can either run this or cancel the procedure. If you do not install the update, the information will reappear in regular intervals until the update has been installed.

Forced update:

Information on an available update is displayed. The module does not decode any more until the update has been successfully implemented.

## Troubleshooting (CA module)

The following information can help, if problems should occur when running a CA module:

Switch the TV set off to the standby mode. Remove the CA module from the TV set. Switch the TV set off completely. Wait a few seconds. Reinsert the CA module. Switch the TV set on again.

If errors continue to occur, make a note of the displayed two-digit error code (only for CI Plus capable CA modules). Contact your technical customer service. You will find the service addresses on page 119.

# External devices

## Connections menu

Settings for the connection of external appliances are made in this menu.

### Calling the connections menu

MENU

**MENU:** Call TV menu.



- ◀ ▶ Select **Connections**,
- ▼ go to the menu line below.

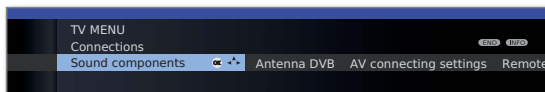

- ◀ ▶ Select the desired setting.

### Explanations of setting possibilities in the Connections menu:

**Sound components** The sound components wizard helps you to configure the components which are used to reproduce the TV sound. You will find a description of the sound components wizard on page 91.

**Antenna DVB** Here you can set the parameters of the DVB-T and the DVB-S antenna with the antenna wizard. The setting options of the DVB antennas are described in the first time operation routine (from page 22).

**AV connecting settings** See right column for explanations.

**Remote TV switch on via Digital Link** Here you can specify whether the TV set should switch itself on automatically from standby mode when a disc is played or a screen menu is displayed on connected **Digital Link HD**-capable equipment which is connected via HDMI (see page 89).

## AV connection settings

In the AV connection settings menu the parameters for the AV and AV-VIDEO connection sockets can be adapted.

### Calling AV connection settings

MENU

**MENU:** Call TV menu.



- ◀ ▶ Select **Connections**,
- ▼ go to the menu line below.

- ◀ ▶ Select **AV connecting settings**,
- ▼ go to the menu line below.

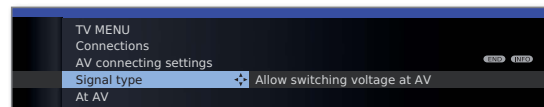

- ◀ ▶ Select the desired setting.

### Explanations of setting possibilities in the AV connecting settings menu:

**Signal type** You set the signal type of the device connected to AV or AV-VIDEO here. Normally, you should leave the setting at **Automatic**; otherwise select a suitable signal type. You can find out more from your dealer.

**Allow switching voltage** If this function is activated and you switch an AV device (not at AV-VIDEO) that outputs a switching voltage to playback, its picture and sound will be played immediately on all TV station slots.

# External devices

## Devices to the connections AV/AV-VIDEO

An additional appliance such as a DVD player, VCR/DVD recorder etc. can be connected to the TV set via an adapter<sup>(1)</sup> at the mini scart socket **AV** (see page 11).

The AV input **AV-VIDEO** (see page 11) offers the possibility of connecting a digital camera or a camcorder for example.

The AV sockets can process different signal types. Which signal type your accessory device provides can be found in the operating manual of the appropriate device.

Owing to the large number of AV devices available on the market, we can only mention a few examples for the connection of accessory equipment to the AV sockets here.

### Connecting a DVD player to the TV set

Switch off all equipment before connecting.

Connect the Euro-AV output of the DVD player to the TV set's mini scart socket **AV** using the Scart adapter<sup>(1)</sup>.

Use a fully equipped Euro-AV cable (available from your dealer) for this.

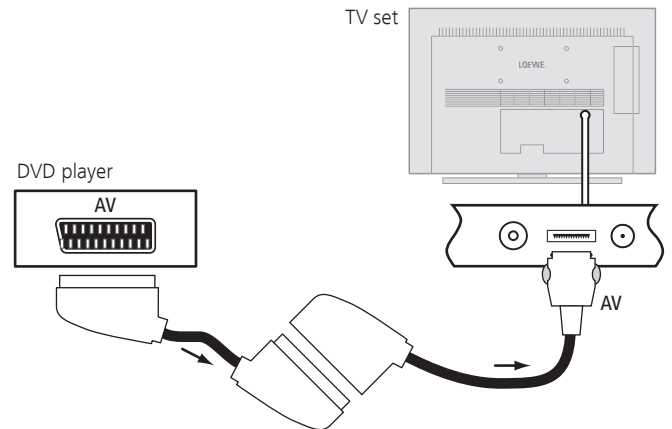

Connection example of a DVD player

### Playback from AV device

If yes was selected to **TV menu** → **Connections** → **AV connecting settings** → **Allow switching voltage at AV**, the TV automatically switches to the corresponding AV input after the playback from the AV device has been started.

The AV input can also be called manually, however.



Call **AV selection**.



▲ ▼ Select **AV**,  
**OK** switch over.

Start playback on the connected device.

<sup>(1)</sup> Scart adapter is available as an accessory (see page 105).

# External devices

english

## Connecting a DVD recorder to the TV set

Switch off all equipment before connecting.

Connect the Euro-AV output of the DVD recorder to the TV set's mini scart socket **AV** using the Scart adapter <sup>(1)</sup>.

Use a fully equipped Euro-AV cable (available from your dealer) for this.

If you want to receive and record analogue stations with the receiver (tuner) built into the recorder, the recorder must be looped into the aerial cable.

Connect the DVD recorder as shown in the connection example below.

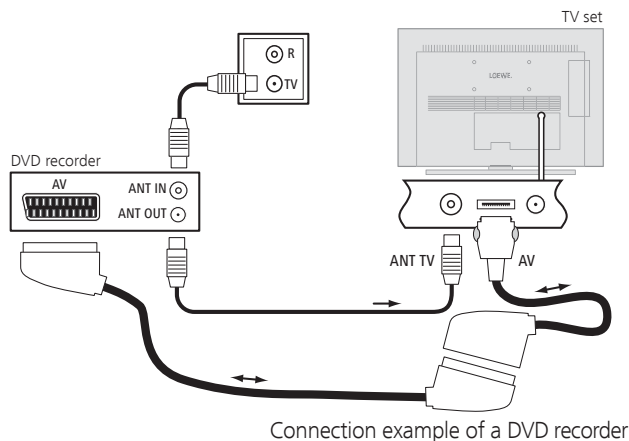

## Playback from AV device



Call **AV selection**.



▲ ▼ Select **AV**,  
**OK** switch over.

Start playback on the connected device.

## Connecting camcorder/camera to the TV set

Switch off all equipment before connecting.

Connect the AV output of the camcorder to the sound input sockets **AUDIO - L** (white) and **R - AUDIO** (red) and the **VIDEO** connection of the side AV sockets of the TV set.

Use the AV cable enclosed with the camcorder for this.

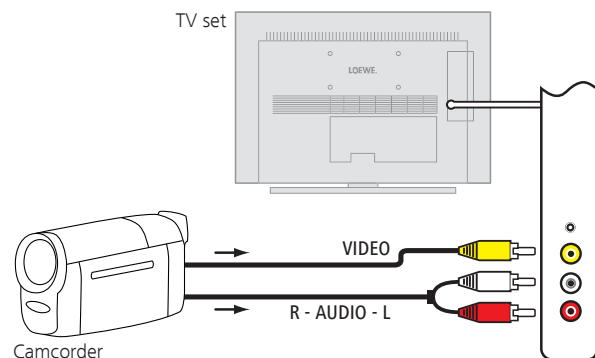

## Playback from AV device



Call **AV selection**.



▲ ▼ Select **AV-VIDEO**,  
**OK** switch over.

Start playback on the connected device.

<sup>(1)</sup> Scart adapter is available as an accessory (see page 105).



# External devices

## Devices to the HDMI connections

The HDMI connections (High Definition Multimedia Interface) allow the transmission of digital video and audio signals from a player (e.g. DVD player, DVD recorder, Blu-ray player, game console or Set-Top-Box) via a single cable.

The digital video and audio data are transmitted without data compression digitally and therefore lose none of their quality.

A maximum of five devices can be connected in cascade to every HDMI socket. The devices are arranged in the AV menu and in the station list below the appropriate HDMI socket. If the respective device sends its own device name, this appears in place of the connection name.

Your TV set can show 24p films, which are output from a connected HDMI player (e.g. Loewe BluTech Vision Interactive) optimally (see glossary, page 110).

Digital video signals from a DVI player can be also be reproduced by the HDMI connection using a DVI/HDMI adapter cable. The sound must be piped in additionally. However, the sound must then be supplied additionally. HDMI and DVI both use the same copy protection method HDCP.

### Connecting the device

Switch off all equipment before connecting.

Connect the device by an HDMI cable (Type A, 19-pole) to one of the **HDMI** sockets of the TV set.

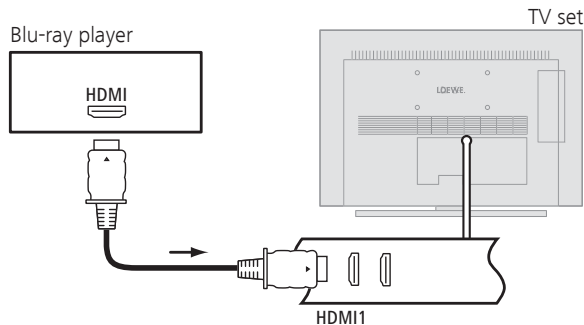

Connection example of an HDMI device (e.g. Blu-ray player)

If a DVI/HDMI adapter cable is used, the associated sound can be fed via the sound input socket **AUDIO IN** (analogue).

### Playback from the device

If the device at **HDMI** supports the **Digital Link HD** functionality, the TV set will automatically switch to the corresponding HDMI input after starting the replay at the HDMI device.

The HDMI input can also be called up manually:



Call **AV selection**.



▲ ▼ Select **HDMI** socket.

With **Digital Link HD**-capable devices the device name may possibly appear in place of the connection name.

**OK** Switch over.

Start playback on the connected HDMI device. The best possible format for the picture is detected and set automatically.

### Remote TV switch on via Digital Link

You can select whether the TV set is to switch on automatically from Standby mode if a disc is played or a screen menu displayed on a **Digital Link HD**-enabled device connected to an **HDMI** input.

You can find the settings in the **TV Menu** under **Connections** → **Remote TV switch on via Digital Link** (see also page 86).

# External devices

## Devices to the PC IN connection

You can connect a PC to the **PC IN** socket for example and thus use the TV screen as a monitor.

➔ When connecting a PCs or accessory device to the **PC IN** socket of the TV set, set the output signal on your PC first so that it matches one of the signals in the table on page 102.

### Connecting the device

Switch off all equipment before connecting.

Connect the device to the TV set's **PC IN** socket with a VGA cable.

Connect the analogue audio signal of the PC to the **AUDIO IN L/R** jack on the TV set with a stereo cable.

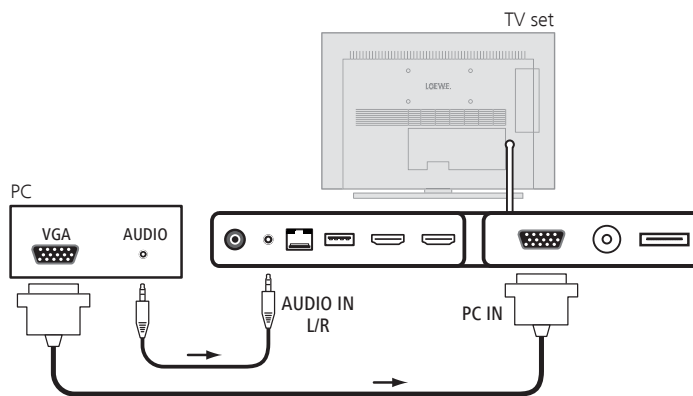

Connection example of a PC

If your PC has an HDMI interface, you can also connect the PC via the HDMI socket to your TV set (see page 89).

Depending on the version of the HDMI connection on the PC, the audio signal is also transmitted via the HDMI connection.

If this is not the case, connect the analogue sound as described above. See the appropriate operating manual for further information about the version of the HDMI interface on your PC.

## Playback from the device



Call **AV selection**.



▲ ▼ Select **PC IN** socket, **OK** switch over.

## PC picture adjustment (only possible with certain signals)

In this menu you can set the position (vertical, horizontal) and the phase length of your PC.



**MENU:** Call **TV menu**.



◀ ▶ Select **Picture**,  
▼ go to the menu line below.

◀ ▶ Select **more ...**,  
**OK** call.

◀ ▶ Select **PC IN display**,  
▼ go to the menu line below.

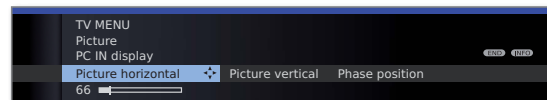

◀ ▶ Select the desired setting,  
▼ go to the menu line below.

◀ ▶ Make settings.

# External devices

## Sound components wizard

The sound component wizard helps you to configure the components that are used to reproduce the TV sound. You can configure the sound playback to come from the TV loudspeakers, active loudspeakers, TV loudspeakers and subwoofer as well as from analogue and digital HiFi/AV amplifiers.

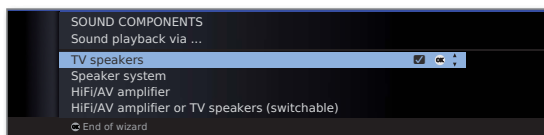

**TV speakers** Sound reproduction via the built-in TV speakers (factory setting).

**Speaker system** Set the sound playback to come from the TV loudspeakers and a connected subwoofer or from active stereo loudspeakers (see page 92).

**HiFi/AV amplifier** Sound reproduction via an external analogue or digital audio amplifier (see page 94).

**HiFi/AV-amplifier or TV speakers (switchable)** Sound reproduction optionally via an external analogue or digital audio amplifier (see page 94) or via the built-in TV loudspeakers. The sound reproduction can be changed using the **button** .

# External devices

## Adjusting the speaker system

If you wish to use active loudspeakers or an active subwoofer, you can connect them to the **AUDIO OUT L/R** socket of the TV set. You will find examples of how to connect these on page 93.

➡ The ports on the TV set are preamplifier outputs. As such, only active loudspeakers may be connected to them.

### Calling the sound components wizard

➡ In normal TV mode, without other displays.

MENU

**MENU:** Call TV menu.



◀ ▶ Select **Connections**,  
▼ go to the menu line below.

◀ ▶ Select **Sound components**,  
**OK** calls the sound components wizard.

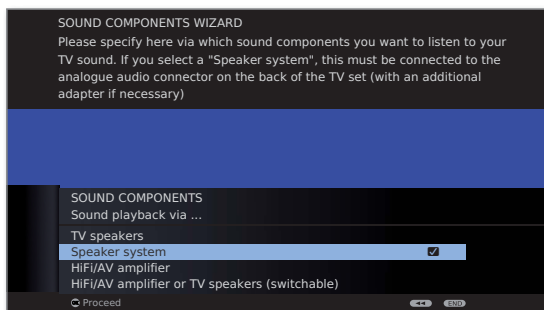

### Sound playback via ... speakers system



▼ ▲ Mark **Speaker system**,  
**OK** to continue.

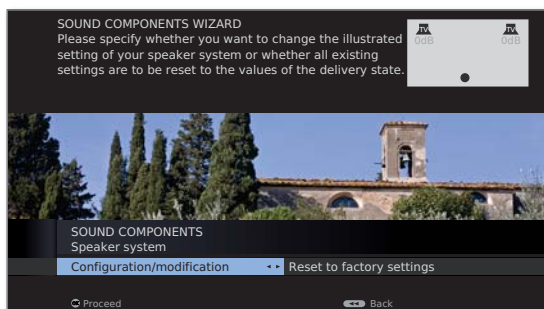

If nothing has been set yet, the factory settings or otherwise the last set values are displayed.

If you want to set up or change a speaker system:



◀ ▶ Select **Configuration/modification**,  
**OK** call selection.

➡ Menu item does **not** appear when first calling up the loudspeaker system configuration.

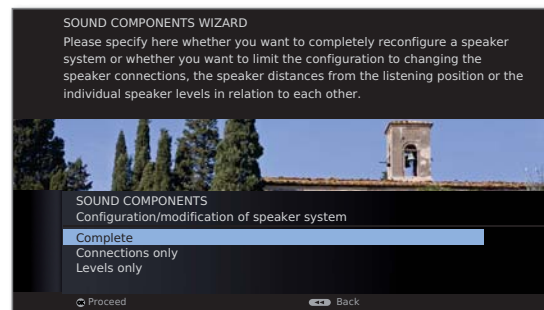

▼ ▲ Select **Complete**,  
**OK** proceed.

➡ Menu item does **not** appear when first calling up the loudspeaker system configuration.

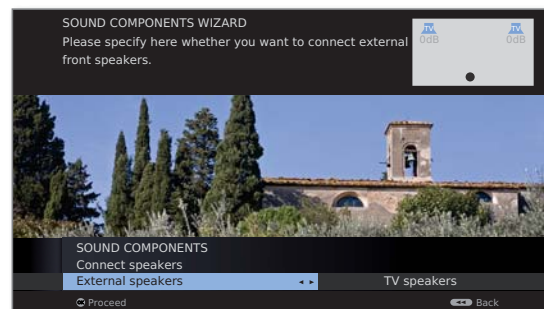

◀ ▶ Mark **External speakers** or **TV speakers**.

To connect a **Subwoofer**, select **TV speakers** here.

**OK** Proceed.

Continued on the next page →



# External devices

## Playing the sound over active loudspeakers

External speakers has been selected.



OK continue to **Adjust speaker level**.

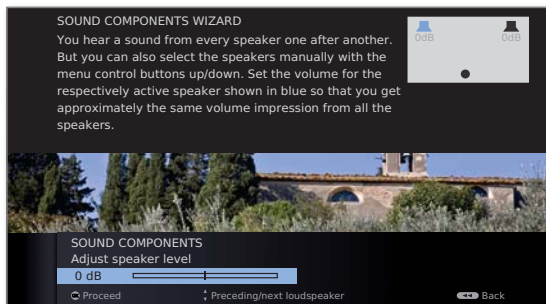

Adjust the volume for each speaker.  
Select speakers manually.

For balanced audio reproduction all speakers should be set at the same volume level. A noise signal will be reproduced automatically on each speaker in succession. Adjust every speaker to equal perceived volume from your listening position.

OK End the wizard.

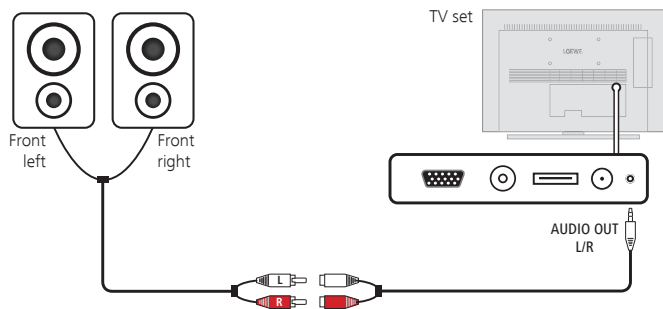

Connection of active speakers to the TV set

## Playing the sound over TV speakers and subwoofer

External speakers has been selected.



OK continue to **Connect subwoofer**.



Select **yes**,  
OK confirm.

**Adjust speaker level:**



Select **yes**,  
OK confirm.

**Subwoofer phase:**



Select **yes**,  
OK confirm.

Test both values (0° and 180°) and choose the one that enables you to hear the bass playback more clearly.

OK Confirm setting and close wizard.

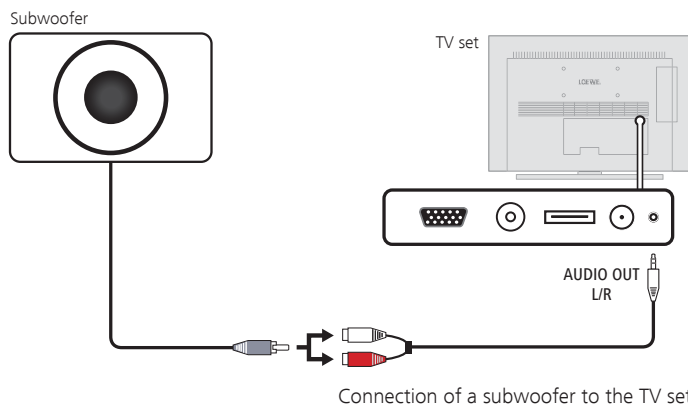

Connection of a subwoofer to the TV set

# External devices

## Connecting HiFi/AV amplifiers

The sound components wizard permits configuration of different audio amplifiers (stereo amplifiers, surround amplifiers, analogue or digital) with different digital audio formats (Dolby Digital, dts, MPEG, and stereo/PCM). See the operating manual of the audio amplifier for more information.

MENU

**MENU:** Call TV menu.



- ◀ ▶ Select **Connections**,
- ▼ go to the menu line below.

- ◀ ▶ Select **Sound components**.
- OK** calls the sound components wizard

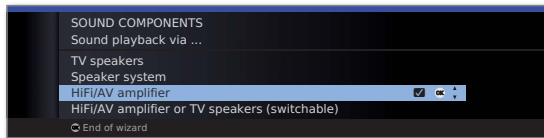

- ▼ ▲ Mark **HiFi/AV amplifier** or **HiFi/AV amplifier or TV speakers (switchable)**.

**OK Proceed.**

- ◀ ▶ Select whether the sound is to be transmitted digitally or analogue to the the amplifier. Continue, depending on the amplifier, see right column.

### Explanations of the setting possibilities:

- |   |  |
|---|--|
| HiFi/AV amplifier                             | Select this setting if an amplifier is connected and you do not wish to use the TV loudspeakers any more.  |
| HiFi/AV amplifier or TV speakers (switchable) | Sound reproduction optionally via an external audio amplifier or via the built-in TV loudspeakers. The playback can be toggled between TV speakers and external audio amplifier in the Sound menu under <b>Sound via</b> . |
| Sound formats                                 | Specify sound formats which can be decoded with the digital amplifier (see operating manual of the used amplifier).  |

### Connecting digital audio amplifiers

Continuation of the left column above ...

For digital audio transmission: Select **yes**.

Connect the digital audio output of the TV set **AUDIO DIGITAL OUT** with the digital audio input of the amplifier via a cinch cable:

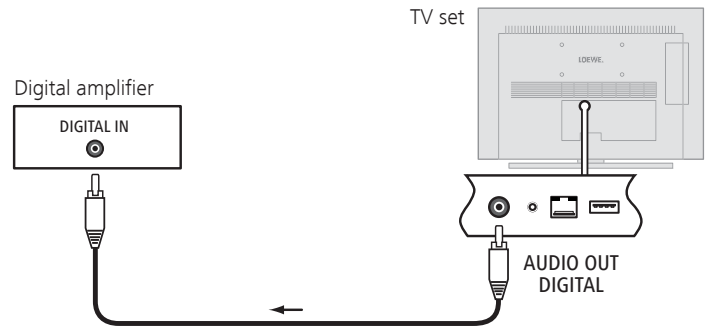

### Connecting analogue audio amplifiers

Continuation of the left column above ...

For digital audio transmission: Select **no**.

Use a stereo cinch cable to connect the analogue audio output **AUDIO OUT L/R** with the analogue audio input of the amplifier:

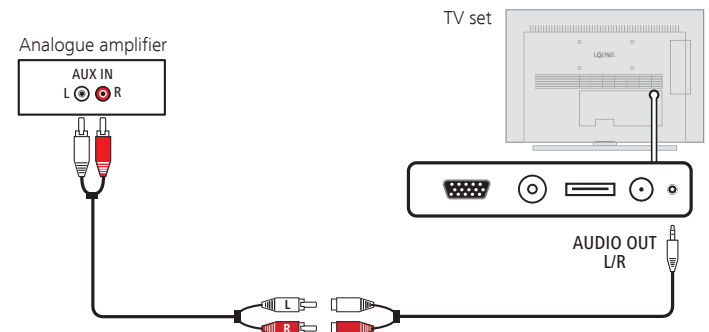

# External devices

## Operating Loewe equipment

### Using the remote control for the TV mode of the TV set

**TV** Press the **TV button**, the display above it will light for approx. 5 seconds.

### Using the remote control for a Loewe recorder

**REC** Press the **REC button**, the display above it will light for approx. 5 seconds.

### Using the remote control for a Loewe player

**DVD** Press the **DVD button**, the display above it will light for approx. 5 seconds.

### Using the remote control for the radio mode of the TV set

**AUDIO** Press the **AUDIO button**, the display above it will light for approx. 5 seconds.

As long as a button is pressed, the display of the selected operating mode lights up (**TV – REC – DVD – AUDIO**). This allows you to check which operating mode the remote control is set to every time you press a button.

The **factory setting** of the buttons **REC**, **DVD** and **AUDIO** is described above (see also table in right hand column). The assignment of the buttons can be changed to suit the existing accessory devices (see right hand column).

### Setting the remote control for other Loewe devices

You can operate various Loewe devices with the remote control. The device keys **REC – DVD – AUDIO** can be reassigned to operate various Loewe devices.

**DVD**  Press the required device buttons and the **STOP button** simultaneously for 5 sec. until the corresponding LED display flashes twice.

Then enter the two-digit device code from the list below. The associated LED display flashes twice.

Device	Code	Factory setting
Loewe ViewVision 8106 H	10	
Loewe Viewvision, Centros 21x2	12	
<b>Loewe ViewVision DR+ DVB-T</b>	<b>13</b>	<b>REC</b>
Loewe Auro 2216 PS/8116 DT	14	
Loewe BluTech Vision Interactive	15	
Loewe Soundprojector	17	
<b>Loewe TV - Digital radio</b>	<b>19</b>	<b>AUDIO</b>
Loewe Mediacenter	20	
<b>Loewe BluTech Vision 3D</b>	<b>21</b>	<b>DVD</b>
Loewe AudioVision	24	
Loewe Individual Sound Projector SL	25	
Apple IR codes	26	
Apple IR codes (Apple TV-2G)	27	
Loewe Soundbox	28	
Loewe SoundVision	29	
Loewe Air Speaker	30	
Loewe MediaVision 3D	35	
Resetting to factory setting	99	

➡ The codes shown here only apply for direct operation of the accessory device.

# Software update

## Basic information

You can update the software on your TV set. In the software update (package update) all the software versions in the TV are scanned and updated as required.

Here you can load up a new piece of software from different sources (where present):

If your TV set is connected to the Internet, the update can be performed directly via the Internet (recommended method, see page 97).

Current software versions can also be downloaded from the Loewe Internet site via a PC and installed on your set using a USB stick (see right column).

## USB stick

### Requirements of USB stick

USB sticks tested by Loewe and compatible in type and format can be ordered from the Loewe dealer using the article no. 90456.990.

If you would like to use your own USB stick, please follow these tips/conditions:

- Formatting in FAT32.
- Only one partition.
- Do not use encrypted USB sticks.
- Do not use USB sticks that simulate a CD ROM drive.
- The stick must not contain any data other than the software update files.
- Data is saved temporarily on the USB stick during the software update process. That means the USB stick must **not** be write-protected.
- For some types of device, the construction of the USB stick is significant. Maximum dimensions in mm: 70x20x10.
- If in doubt, the USB stick should be formatted as "FAT32" without "extended attributes".

## Software update via USB

### Software download from the Loewe Internet site

Where available, you can download new software for your TV set from our homepage.

To do this, visit our homepage at:

<http://support.loewe.tv> (International),  
<http://support.loewe.tv/uk> (United Kingdom and Republic of Ireland),  
<http://support.loewe.tv/au> (Australia) or  
<http://support.loewe.tv/nz> (New Zealand)

Choose **Register now** or **Register free-of-charge** on the support homepage. Follow the individual registration process instructions.

After the successful registration process and subsequent login to the support homepage you have to register your set (have the article number and serial number ready – both of these are on a label stuck to the back of the set or can be seen under **TV equipment** in the index of the TV set (see page 15).

Then you will get a list of downloadable contents for your TV set including the software for your TV set. Download the files and unzip all the files in this ZIP archive to the main directory of your **empty** USB stick.

Switch the TV set off using the power switch.

Insert the USB stick with the downloaded software into a free USB port on the TV set (see connections page 11).

Only switch the TV set on again **via the power switch**. The update will now be carried out automatically. Whilst updating, the LED display on the control panel (see page 10) lights up orange. The display remains switched off during the update.

After approx. 2 minutes, the LED display on the control panel changes from orange to red. Now eject the USB stick from the TV set and switch the TV set back on.

Check the installed software version in the index of the TV set under **Integrated features - Software**.



# Software update

## Software update via internet

Do **not** insert a USB stick with downloaded software when updating software via the Internet.

### Calling Software update

MENU

**MENU:** Call TV menu.



◀ ▶ Select **Settings**,  
▼ go to the menu line below.

◀ ▶ Select **Miscellaneous**,  
▼ go to the menu line below.

◀ ▶ Select **Software update**,  
**OK** call software update wizard.  
The wizard searches for new software.

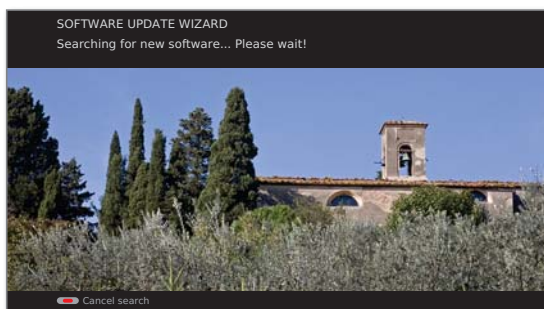

If a new software version is available after the search, the following on-screen message appears (see right column).

If no new software package was found in the search:

END

**END:** Exit wizard.

### New software package found

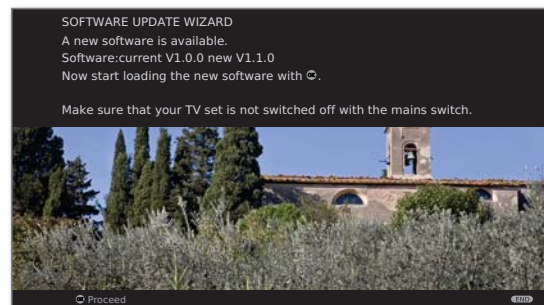

**OK Proceed.**

**OK** Start loading software.

END

**END:** Exit wizard.

### Load new software package

The TV set switches off after confirmation. The software is now loaded. The loading process can take up to 10 minutes.

After completing the update, the TV set switches on again. You will see a message on the screen.

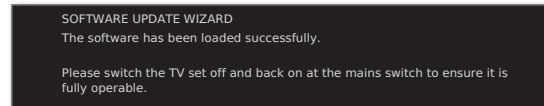

Switch the TV off and back on at the mains switch.

# Input of characters

## Character table

Key assignment for text input via the remote control For certain functions the input of letters or characters is required. As with a cell phone press the numeric button (0-9) repeatedly until the desired character appears.

- The characters available are language dependent.  
Here the key assignment is for the menu language **English**.

Button	Character (uppercase - lowercase)
1	1
2	ABC2 - abc2
3	DEF3 - def3
4	GHI4 - ghi4
5	JKL5 - jkl5
6	MNO6 - mno6
7	PQRS7 - pqr7
8	TUV8 - tuv8
9	WXYZ9 - wxyz9
0	0 [space] . \ - + _ , ; : ? ! = & # % @ ~ * ' \$   ( )

# Troubleshooting

Problem	Possible cause	Remedy
All menus are displayed in the <b>wrong language</b> .	The menu language was set incorrectly.	<b>Set the menu language:</b> Press the <b>MEDIA button</b> in <b>TV mode</b> . In the <b>MediaPortal</b> , highlight the last menu item ( <b>Index</b> ) in the upper half and call up with <b>OK</b> . Mark the first key word and call it with <b>OK</b> . Then select the language and confirm it with <b>OK</b> .
In the <b>TV menu</b> , <b>Connections</b> cannot be called (displayed in grey).	A timer recording is in progress.	Wait until the timer recording ends or delete the timer recording (page 77).
General problems when connecting <b>external devices</b> via an <b>AV input</b> .	The <b>signal type</b> is set incorrectly.	Set the correct signal type (page 86).
With <b>Teletext</b> various <b>characters</b> are displayed incorrectly.	The wrong character set has been set in the menu.	Set the right character set: Select <b>TV menu</b> → <b>Settings</b> → <b>Miscellaneous</b> → <b>Teletext character set</b> → <b>West</b> or the appropriate character set.
Errors occurred when running a CA module.		Switch the TV set off. Remove the CA-module from the TV set. Wait a few seconds. Reinsert the CA-module. Switch the TV set on again.
<b>No sound</b> via the external digital <b>audio amplifier</b> .	a) The external digital audio amplifier does not support the selected sound format (Dolby Digital, dts, MPEG).  b) TV set and external digital audio amplifier are not connected with each other.	a) Set PCM stereo on the DVD player in the sound selection. For DVB stations on the TV set switch to stereo in the <b>Status display (INFO) – Language/sound (green button)</b> .  b) Connect <b>AUDIO DIGITAL OUT</b> from the TV set to a <b>digital</b> input of the external digital audio amplifier and select the appropriate input to this.
The picture format cannot be adjusted.	A HbbTV application is loaded but is not active (not displayed).	End the HbbTV application with the <b>END button</b> (see page 68).
The free capacity of the external hard disk is essentially indicated smaller than expected in the OSD.	The hard disk has been formatted on FAT32 on a PC with Microsoft Windows (see also page 71).	Format external hard disk on TV set again via <b>TV menu</b> → <b>Settings</b> → <b>Miscellaneous</b> → <b>Format external hard disk</b> .
Your TV set is not assigned an IP address with <b>automatic</b> IP configuration method.	No DHCP server is working on your network.	Set up a DHCP server. Assign the IP addresses for the TV set manually.

# Troubleshooting



Problem	Possible cause	Remedy
Despite video or music file being played back, no sound can be heard.	<p>a) The TV set is set to mute or the volume has been turned down too far.</p> <p>b) An audio device that does not exist or that is not connected is registered in the <b>TV menu</b> under <b>Connections</b> → <b>Sound components</b> (e.g. <b>HiFi/AV amplifier</b>).</p>	<p>a) Increase the volume by pressing the <b>V+</b> <b>button</b> on the remote control for longer. This will also cancel any mute setting.</p> <p>b) Connect up the audio device and switch it on. In the <b>Sound components wizard</b> change back to <b>TV speakers</b>.</p>
Although the file is visible on the media server, it is not displayed in the MediaPortal.	The file is not made available by your media server.	Change to your media server. For this, read the section Media server software on page 104.
A media file that is displayed can not be played back.	The format of the file is not supported (see also limitations in section <b>File formats supported</b> on page 104).	No remedy.
Characters received in the WLAN code of the wireless router cannot be entered for the network configuration at the TV set.	The device does not support all special characters.	Change the WLAN key of the router.
When searching for wireless routers, no device is found.	The router is not ready for wireless communication.	Check your wireless router. Try to make the connection again a few minutes later.

If with **wireless** operation there should be any interference such as disruptions during playback or slow reactions by devices to commands, you could try the following:

- Keep at least three metres distance from microwave ovens, bluetooth devices, mobile telephones and Wi-Fi compatible devices such as printers and PDAs.
- Change the active channel on the WLAN router.

# Technical data

## General data

Type	Xelos 46 	Xelos 40 	Xelos 32 
Article number	52458xxx	51439xxx	51429xxx
Dimensions for device without stand (W x H x D) in cm Dimensions for device with stand (W x H x D) in cm	110.3 x 69.8 x 6.5 110.3 x 72.8 x 24.7	98.4 x 62.4 x 6.5 98.4 x 65.4 x 24.7	78.0 x 51.2 x 6.0 78.0 x 55.3 x 24.7
Weight for device without stand (approx.) in kg Weight for device with stand (approx.) in kg	17.3 19.7	15.7 18.1	11.3 13.0
Display technology	Full-HD LCD with Edge-LED backlight		
Screen diagonal (in cm) / Picture format	117 / 16:9	101 / 16:9	80 / 16:9
Resolution (in pixels) / Motion Response	1920 x 1080 / 100 Hz		
Contrast (static / dynamic)	4,000 : 1 / 4,000,000 : 1		1,500 : 1 / 1,500,000 : 1
Viewing angle (horizontal / vertical)	178° / 178°		
Power consumption On-Mode max. (W) (Audio output 1/8 of the maximum value)	109	102	84
Power consumption On-Mode Home (W)	75	80	60
Power consumption in Standby Mode (W)	0,20	0,17	0.20
Power consumption when set is switched off (W)	0	0	0
Ambient temperature (Celsius)	5° – 35°		
Relative humidity (non-condensing)	20 – 80%		
Air pressure	800 – 1114 hPa (0 – 2000 m above sea level)		

# Technical data

## Electrical data

Chassis designation:	MB 180	
Power supply:	220 V – 240 V/50–60 Hz	
Tuner:	terr./cable:	VHF/hyperband/UHF
	satellite:	4 levels: 13/18V/22kHz 16 levels: DiSEqC 1.0
		Single cable system: EN 50494
Range:	terr./cable:	45 MHz to 860 MHz
	satellite:	950 MHz to 2150 MHz
Station storage locations incl. AV and radio:	5000	
TV standards:	analogue:	B/G, I, L, D/K
	digital:	DVB-T, DVB-C DVB-S / S2
Colour standards:	SECAM, PAL, NTSC, NTSC-V, PAL-V (60 Hz)	
Sound standards:	analogue:	mono, stereo, dual-channel
	BG, DK:	FM-A2
	BG, I, DK:	FM-Nicam
	L, L1:	AM-Nicam
	digital:	mono, stereo, dual-channel, PCM Dolby Digital Dolby Digital Plus
Audio output power (music/sine):	Xelos 46 / Xelos 40:	2 x 24W / 2 x 12W
	Xelos 32:	2 x 20W / 2 x 10W
Teletext:	TOP v1.5 / FLOF FastText	
Page memory:	1000	

## Signals via PC IN / HDMI

The following table lists the compatible signals which your TV set can show via the **PC IN** connection and the HDMI connections (**HDMI1**, **HDMI2**).









Set the output signal on your PC, HDMI or DVI device so that it matches one of the signals in the table.

Format	Horizontal	x	Vertical	Image frequency	Connection
480i60	720	x	480i	60Hz	PC IN, HDMI
576i50	720	x	576i	50Hz	PC IN, HDMI
480p60	720	x	480p	60Hz	PC IN, HDMI
576p50	720	x	576p	50Hz	PC IN, HDMI
	1440	x	480p	60Hz	HDMI
	1440	x	576p	50Hz	HDMI
720p50	1280	x	720p	50Hz	PC IN, HDMI
720p60	1280	x	720p	60Hz	PC IN, HDMI
1080i50	1920	x	1080i	50Hz	PC IN, HDMI
1080i60	1920	x	1080i	60Hz	PC IN, HDMI
1080p24	1920	x	1080p	24Hz	PC IN, HDMI
1080p25	1920	x	1080p	25Hz	PC IN, HDMI
1080p30	1920	x	1080p	30Hz	PC IN, HDMI
1080p50	1920	x	1080p	50Hz	HDMI
1080p60	1920	x	1080p	60Hz	HDMI
VGA	640	x	480	60Hz	PC IN, HDMI
SVGA	800	x	600	60Hz	PC IN, HDMI
XGA	1024	x	768	60Hz	PC IN, HDMI
WXGA	1360	x	768	60Hz	PC IN, HDMI
SXGA	1280	x	1024	60Hz	PC IN, HDMI

✂  
The code number  cancels an access  
code and thus the parental  
lock. Please keep  
in a safe place.

# Technical data

## Connections (max. equipment)

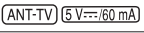
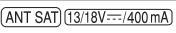
Designation	Type	Function / Signal	
	Mains socket	220-240V ~ 50/60Hz	Supply voltage
	HDMI type A (2x)	Digital Video/Audio IN:	Digital video <sup>(1)</sup> and audio
	D-SUB 15-pole	Video IN:	PC/STB video signal <sup>(1)</sup>
		Video IN:	CVBS (VHS/8 mm) RGB
	Mini Scart	Video OUT: Audio IN: Audio OUT:	CVBS (VHS/8 mm) L/R L/R
	RJ-45	Ethernet / Fast Ethernet:	Network interface
	USB type A (2x)	USB 2.0 (500mA):	Multimedia files/software update
	Jack 3,5 mm	Audio IN:	L/R
	Cinch	Digital Audio OUT (SPDIF):	Digital audio
	Jack 3,5 mm	Audio OUT:	L/R
	IEC socket	75Ω / 5 V / 60 mA:	Cable analogue / DVB-T / DVB-C
	F socket	75Ω / 13/18 V / 400 mA:	DVB-S/S2
	CI slot	COMMON INTERFACE	Slot for CA module
	Jack 3,5 mm		Headphones 32–2000 Ohm
	Cinch (white/red)	R - AUDIO - L	L (white) / R (red)
	Cinch (yellow)	VIDEO	CVBS (VHS/8 mm)

<sup>(1)</sup> For compatible picture signals, see table on page 102.

# Technical data

## MediaHome

### File formats supported

**Pictures:** JPG, PNG, GIF

**Audio:** MP3, M4A (AAC LC), WMA (without lossless), WAV (PCM)

**Video:** AVI (MPEG-1/2, DivX, XviD, AC3, MP3), WMV (WMV9, VC-1, WMA9, WMA Pro), MP4 (DivX, XviD, H.264/MPEG-4 AVC, AAC LC), MOV (H.264/MPEG-4 AVC, AAC LC), MKV (H.264/MPEG-4 AVC, AC3), MPG (MPEG-1, MPEG Audio), TS/PS (MPEG-2, H.264/MPEG-4 AVC, MPEG2 Audio, AC3), VOB (MPEG-2, MPEG2 Audio, AC3), DivX

- ➡ DivX up to a resolution of 720x480x30 or 720x576x25
- ➡ Maximum data transmission rate 4,000 kbps
- ➡ DivX codecs: 3, 4, 5, 6
- ➡ DivX Video on Demand (VoD): yes
- ➡ H.264/MPEG-4 AVC up to Profile High (Level 4.2)

### Ethernet (wired network)

Standards supported: 10 Mbit/sec Ethernet (10Base-T), 100 Mbit/sec Fast Ethernet (100Base-T)

### WLAN (wireless network) <sup>(1)</sup>

#### Standards supported:

IEEE 802.11b/g/n

#### Frequency range used:

2400-2483.5 MHz and 5180-5730 MHz

#### Types of encoding that are supported:

WEP 64 and 128 Bit (ASCII and HEX), WPA PSK, WPA2 AES

### Supported home network standard

Universal Plug and Play Audio / Video (UPnP AV)

### Media server software

To play multimedia contents from devices in your home network, you require media server software which makes the relevant files available to you. Handling of individual files depends on the technical properties and also on the media server software used.

You can download a test version of the **TwonkyMedia Mediaserver** from our homepage. With your TV set, you have also acquired the option of obtaining a free licence for the currently available version of the Twonky media server. Alternatively, you can also use other media servers, e.g. the **Windows Media Player (WMP) from Version 11**.

For communication with your PC, certain **port addresses** of the network connection are required. They may not be blocked by a firewall if there is one, otherwise this could cause serious connection errors.

Windows Media Player 11 requires the port addresses 1900 and the block of 10280 up to and including 10284 (all for UDP) as well as 2869 and 10243 (both for TCP). For TwonkyMedia the port addresses 1030, 1900 and 9080 (all for UDP) and 9000 (for TCP) must be available.

Other ports to be kept free depend on the operating system you are using. Contact your network administrator about configuring the firewall.

<sup>(1)</sup> The WLAN USB stick is available as an accessory (see page 105).



# Accessories

## Accessories

The following accessories are obtainable from your Loewe dealer.

### Installation options:

A large range of options for floor, table or wall installation are available for your TV set.

An overview of the available options can be found on page 107.

### Loewe DVD recorder:

The DVD recorders from Loewe are characterised by form and colour, which match Loewe TV sets, adapted user guidance and technology. Combined these devices form a system that offers many advantages.

### Loewe Blu-ray player:

With the Loewe Blu-ray player **BluTech Vision 3D** you are ideally equipped for the successor format to DVD. With the Loewe system integration you control BluTech Vision 3D and your Loewe TV set simultaneously with the Assist remote control.

### Loewe MediaVision 3D:

Loewe MediaVision 3D is partly an audio system: It plays your favourite sound via the integrated iPod / iPhone dock and automatically identifies songs or film music with the MusicID function. Loewe MediaVision 3D is also a home cinema system, ensuring a perfect all-round audio visual experience - thanks to the fast and precise Full-HD 3D Blu-ray drive and a 5.1 decoder. Not least, Loewe MediaVision 3D is a colourful feast for the eyes: because it can be beautifully customised by individual intarsia.

### Loewe Vesa adapter bolts:

You can purchase adapter bolts for wall holders in line with the VESA standard from your dealer or the technical customer service (see service addresses on page 119). Four items are required.

Spacer bolts (1 item) Loewe order no. 70873.001.

### Loewe Scart adapter:

The Scart adapter allows you to extend your TV set by adding a full Euro-AV socket to connect DVD players or DVD recorders, for example. Owing to the low unit depth, the adapter has a length of approx. 25 cm so as to ensure a neat installation of the rear panel cover.

We recommend connecting devices via an HDMI interface, if possible.

### Loewe WLAN USB-Stick:

The Loewe WLAN USB stick enables you to connect your TV set wirelessly to your home network.

We recommend using a USB extension (see below) or an angle adapter to set the WLAN range optimally.

### USB extension:

To ensure easy accessibility of the USB connection or enable USB sticks to be inserted with a large casing, the TV set can be connected to a USB extension. You can purchase the USB extension via your Loewe dealer.

# Accessories

## Equipment variants

The equipment of the individual set variants and their upgrade/conversion possibilities is listed in the table below.

Set variants	Xelos 46	Xelos 40	Xelos 32
Digital Recorder	<input type="checkbox"/>	<input type="checkbox"/>	<input type="checkbox"/>
DVB-T/C Single	●	●	●
DVB-S2 Single	●	●	●
HbbTV	●	●	●
WLAN	○	○	○

- ex factory
- available as an accessory
- only with connected USB storage device

## TV set equipment

See the rating plate on the rear of the set for the precise product designation. The precise features are listed in the **Integrated features** item in the index of the TV set (see page 15).

# Accessories

## Setup possibilities



Table Stand

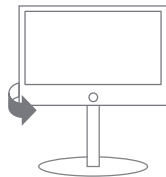

Floor Stand 8 32-40 <sup>(1)</sup>  
Floor Stand 8 42-47 <sup>(1)</sup>

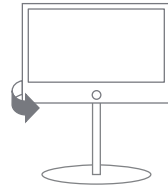

Floor Stand Universal 32-46 <sup>(1)</sup>

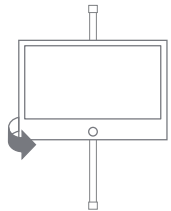

Screen Lift Plus <sup>(1)</sup>



Wall Mount WM63  
Wall Mount WM64  
Wall Mount Slim / VESA Size 400

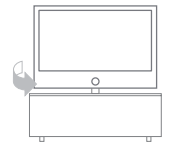

Rack 110.30 <sup>(1)</sup>  
Rack 110.30 SW <sup>(1)</sup>

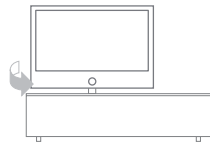

Rack 165.30 <sup>(1)</sup>

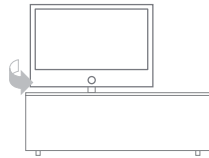

Rack 165.45 CS <sup>(1)</sup>  
Rack 165.45 SP <sup>(1)</sup>

## Xelos 32

- Table Stand (scope of delivery)
- Floor Stand 8 32-40 <sup>(1)</sup>
- Floor Stand Universal 32-46 <sup>(1)</sup>
- Wall Mount WM63
- Rack 110.30 <sup>(1)</sup>
- Rack 110.30 SW <sup>(1)</sup>
- Rack 165.30 <sup>(1)</sup>
- Rack 165.45 CS <sup>(1)</sup>
- Rack 165.45 SP <sup>(1)</sup>

## Xelos 40

- Table Stand (scope of delivery)
- Floor Stand 8 32-40 <sup>(1)</sup>
- Floor Stand Universal 32-46 <sup>(1)</sup>
- Screen Lift Plus <sup>(1)</sup>
- Wall Mount WM64
- Wall Mount Slim / VESA Size 400
- Rack 110.30 <sup>(1)</sup>
- Rack 110.30 SW <sup>(1)</sup>
- Rack 165.30 <sup>(1)</sup>
- Rack 165.45 CS <sup>(1)</sup>
- Rack 165.45 SP <sup>(1)</sup>

## Xelos 46

- Table Stand (scope of delivery)
- Floor Stand 8 42-47 <sup>(1)</sup>
- Floor Stand Universal 32-46 <sup>(1)</sup>
- Screen Lift Plus <sup>(1)</sup>
- Wall Mount WM64
- Wall Mount Slim / VESA Size 400
- Rack 110.30 <sup>(1)</sup>
- Rack 110.30 SW <sup>(1)</sup>
- Rack 165.30 <sup>(1)</sup>
- Rack 165.45 CS <sup>(1)</sup>
- Rack 165.45 SP <sup>(1)</sup>

<sup>(1)</sup> Only in connection with appropriate adapter to be ordered separately.

# Environment

## Environmental protection

### Energy consumption

Your TV set is equipped with an eco-standby power supply. In the standby mode, the power consumption drops to low power (see Technical data on page 101). If you want to save even more energy then switch the device off with the mains switch. Please also note that the EPG data (Electronic Programme Guide) is lost and possibly programmed timer recordings **cannot** be carried out via the TV set.

The power consumed by the TV set during operation depends on the energy efficiency preset in the initial installation (see page 22) or the setting in the TV menu (see page 35).

If you activate the automatic dimming (see page 35), your TV picture will adapt to the ambient brightness. This reduces the power consumption of the TV set.

If the TV is not operated for 4 hours (adjustment of volume, programme change, etc.) the TV will automatically switch to stand-by mode to save energy. A prompt to terminate this shutdown process appears one minute before expiry of the 4 hours. The automatic shutdown is only active in the energy efficiency mode **Home Mode**. Automatic shutdown does **not** occur when using the radio **without** screen display (**screen off**).

### Packaging and box

You have made a decision to purchase a high-quality technical product with a long service life. For disposal of the packaging, in accordance with national legislation we have paid a fee to a commissioned recycler to pick up the packaging from the dealer.

### The set



The EU directive 2002/96/EC regulates the proper way to recycle, handle and utilise used electronic devices. **Old electronic devices** consequently must be disposed of separately. Please do **not** dispose of this device in normal **household trash!**

You may return your used set free of charge at designated recycling centres or at your specialist dealer whenever you purchase a new, comparable set. Additional details about return (also for non EU countries) are available from your local municipal authorities.

### Batteries



The batteries supplied as initial equipment do not contain any pollutants such as cadmium, lead, or mercury. Used batteries should **no longer** be disposed of in the **domestic waste** according to the Battery Ordinance. Dispose of your batteries at no charge in the **collection containers** which are set up for this purpose in retail stores.

# Legal notes

## Trademarks

Manufactured under licence from Dolby Laboratories. "Dolby", "Pro Logic" and the double-D symbol are trademarks of Dolby Laboratories.



ABOUT DIVX-VIDEO: DivX® is a digital video format developed by DivX, Inc. This is an official DivX Certified device for playing DivX video. You can find further information and software tools for converting files to DivX videos at [divx.com](http://divx.com).

ABOUT DIVX VIDEO-ON-DEMAND: This DivX Certified ® device must be registered for playing purchased DivX Video-on-Demand (VOD) Movies. A registration code can be compiled in the section DivX VOD in the Settings Menu of the unit. You can find further information on the registration at [vod.divx.com](http://vod.divx.com). DivX®, DivX Certified® and the associated logos are trademarks of DivX, Inc. and are licensed.

DivX and the associated DivX logos are trademarks of DivX, LLC, a subsidiary of Rovi Corporation.



The screen font "Loewel2700" is based on the "Tavmjong Bah Arev (tavmjong.free.fr)" font, which in turn is based on "Bitstream Vera". Bitstream Vera is a trademark of Bitstream Inc.

This set contains a software which is based partly on the work of the Independent JPEG Group.

This product includes software developed by the OpenSSL Project for use in the OpenSSL Toolkit (<http://www.openssl.org/>).

This software is provided by the OpenSSL project "as is" and any expressed or implied warranties, including, but not limited to, the implied warranties of merchantability and fitness for a particular purpose are disclaimed. In no event shall the OpenSSL project or its contributors be liable for any direct, indirect, incidental, special, exemplary, or consequential damages (including, but not limited to, procurement of substitute goods or services; loss of use, data, or profits; or business interruption) however caused and on any theory of liability, whether in contract, strict liability, or tort (including negligence or otherwise) arising in any way out of the use of this software, even if advised of the possibility of such damage.

This product includes cryptographic software written by Eric Young ([ey@cryptsoft.com](mailto:ey@cryptsoft.com)).

This product includes software written by Tim Hudson ([tjh@cryptsoft.com](mailto:tjh@cryptsoft.com)).

This product contains software which was developed by third parties and / or software which is subject to GNU General Public License (GPL) and/or GNU Lesser General Public License (LGPL). You can pass on and modify them in accordance with Version 2 of the GNU General Public License or optionally every later version which is published by the Free Software Foundation.

Loewe publishes this programme WITHOUT ANY GUARANTEE OR SUPPORT especially without an implicit guarantee of MARKET MATURITY or APPLICABILITY FOR A CERTAIN PURPOSE. Details can be found in the GNU General Public License. You can order the software from Loewe Customer Service.

You can download the GNU General Public License here: <http://www.gnu.org/licenses/>.

# Glossary

## 0-9

**24p movie display:** Films released on Blu-ray Disc support presentation of 24p cinema films. The Blu-ray player transfers the original film format to the television with 24 frames per second. The DMM (DigitalMovieMode) set in the factory calculates and inserts additional intermediate pictures, which suppress film jerking typical for the cinema, thereby providing for a smooth motion sequence.

## A

**Active antenna:** An antenna with its own power supply or amplification which can improve the reception in areas with a poor coverage.

**Administrator:** Person who administers the network, i.e. takes care of setting up and maintaining all components belonging to the network.

**Automatic time control:** Similar to **VPS** for analogue stations the automatic time control monitors the start and end times of programmes from DVB stations. If these times deviate from the data programmed in the timer data the running time of the recording is adapted automatically. The automatic time control is not supported by all DVB stations.

**AVI:** Abbreviation for Audio Video Interleave, a video container file format developed by Microsoft. A single AVI video file can contain several audio, video and text data streams (thus the name container format).

**AV socket:** Socket for audio and video signals.

**AV sources:** Audio/video source.

**AVS:** Audio/video sockets on the side of the TV set (cinch and mini-DIN).

## B

**Band:** Name for a transmission range.

**Blu-ray Disc:** The follow-up format of **DVD**. The contents of about five DVDs fit onto one Blu-ray Disc (abbreviated BD). Therefore, the Blu-ray disc provides enough space for high-resolution images and multi-channel sound formats.

**BMP:** Abbreviation for Bitmap, a grid graphics format designed for Microsoft Windows and OS/2 that is wide spread and therefore supported by almost every popular graphics software package without any problems.

## C

**CA module:** The **Conditional Access module** contains the coding system and compares the transmitted code with the one on the **Smart Card**. If they match, the appropriate stations or programmes are decoded.

**CEC:** Abbreviation for Consumer Electronics Control. CEC provides universal component control functions for entertainment electronics devices (e.g. System standby, One Touch Play). CEC is also known as **Digital Link HD** at Loewe.

**Channel (WLAN):** The channel is a certain part of the WLAN frequency band. Devices that want to communicate with each other have to use the same WLAN channel. In Europe the WLAN frequency band is currently divided into 13 channels.

**Cinch cable:** Cable for transmitting audio or video.

**CI slot:** See **Common Interface**.

**Client:** Also referred to as network client; describes an end device such as your TV set that is connected to the network and gets data from a (media) server to make it accessible to the user.

**Common Interface:** The Common Interface (CI slot) is a standardised interface. By inserting suitable decoding modules (**CA modules**) and a **Smart Card** coded digital programmes can be used.

**Common Interface Plus:** CI Plus is an advanced development of the **Common Interface** standard. CI Plus slots are in principle downward compatible to the previous CI standard, i.e. CA modules and Smart Cards according to the past CI standard can continue to be used in CI Plus slots, as far as the programme provider permits this. Additionally, extended regulations apply however to CI Plus.

**Component:** See **Component connection**.

**Component connection:** Also referred to as **Component**. Connection where the video signal is transferred via three separate (Cinch) connections. It comprises the brightness signal **Y** as well as the colour difference signals **Pb** (blue component) and **Pr** (red component).

**Conditional Access module:** See **CA module**.

## D

**Decoder:** Analogue, coded TV signals are passed through a decoder and made visible again.

**DHCP:** Abbreviation for Dynamic Host Configuration Protocol. DHCP allows automatic assignment of IP addresses with the aid of a DHCP server.

**DHCP server:** Network service which takes care of automatic assignment of IP addresses to clients.

**Digital Link:** System for controlling recorders (for video and DVD recorders from Loewe) via the Euro AV sockets of the Loewe TV set with concealed setup. Controlling the recorder for timer recordings.

**Digital Link HD:** System for controlling devices via the HDMI connection of the Loewe TV set in the case of concealed installation.

**Digital Link Plus:** System for controlling recorders according to protocol 50. For analogue stations the station and timer data are transmitted via the EURO-AV socket to the recorder. The timer recording is executed exclusively by the recorder. There is a different designation with different manufacturers.

**DivX:** Video Codec which allows even large files to be relatively highly compressed in their file size without having to tolerate important quality losses.

# Glossary

**DMM:** Abbreviation for „Digital Movie Mode“. Whether a studio recording, live broadcast, or feature film – the broadcast images are always displayed optimally. Still images are reproduced in all their sharpness and tranquillity. By creating intermediate images, DMM enables perfect studio quality, even with quick movements.

**DNC:** Abbreviation for „Digital Noise Control“. Weak TV signals (analogue) can generate disruptive picture noise. DNC adjusts the effect of digital noise reduction to the picture contents.

**DNS:** Abbreviation of Domain Name System. Readable names (e.g. www.loewe-int.de) are assigned to numerical **IP addresses**. DNS servers are responsible for the resolution of readable addresses into the corresponding IP addresses.

**Dolby Digital:** Digital multi-channel audio. The digital standard for high quality home movie systems. The individual channels are broadcast separately in this standard. The three front channels right, left and centre, the two surround channels right and left and the external subwoofer channels are called a 5:1 signal.

**Dolby Pro Logic:** Analogue multi-channel audio. Converts a Dolby-coded stereo signal into a surround sound. This usually contains four channels (front left, centre, front right, surround channel). A special subwoofer channel is not generated in this method.

**Dolby Pro Logic II:** Analogue multi-channel audio. Dolby Pro Logic II is a further development of **Dolby Pro Logic**. This method generates a 6-channel spatial sound from a stereo or Pro-Logic signal (front left, centre, front right, surround left, surround right, subwoofer).

**Dolby Surround:** Analogue multi-channel audio system that brings four audio channels down to two audio tracks with the aid of a matrix coding.

**Dolby Virtual Speaker:** The Dolby Virtual Speaker technology simulates the surround playback of a real 5.1-channel playback with only two speakers.

**DRM:** Digital Rights Management. Processes to control copyright protected data. To be used correctly, DRM protected contents require not only a DRM capable device but also the possession of a license issued by the provider (to be paid for).

**DTS:** Digital Theater Systems; Digital multi-channel audio.

**DVB-C/S/T:** Digital Video Broadcasting stands for digital television. Technical DVB is the standardised process for transmitting digital content (television, radio, multi-channel audio, room sound, **EPG**, Teletext, and other supplemental services) through digital technology. **C** stands for transmission via cable, **S** for distribution via satellite and **T** for terrestrial or antenna distribution.

**DVD:** Abbreviation of Digital Video Disc and later Digital Versatile Disc.

**DVD preceiver:** Combi-device of DVD player and radio without integrated amplifier.

**DVI:** Digital Visual Interface, is an interface for transmitting digital video and graphic data (without audio).

**Dynamic contrast ratio:** Here the light intensity of the display is adapted in case of a high black portion in the picture. The so-called backlights are dimmed automatically and the contrast ratio increases temporarily, i.e. dynamically.

## E

**Electronic Programme Guide:** See **EPG**.

**EPG:** Electronic Programme Guide is the electronic variant of a printed TV guide. Using the EPG you can watch the TV programme of the TV station, transfer the appropriate data. The list of programmes contains the title, beginning and end and duration of the programme. In addition brief descriptions of the content of the programmes is also displayed.

**Ethernet:** Cable linked data net technology for local networks (LANs). Also covers standards for e.g. plug connectors and transfer speeds.

**Euro AV socket:** Interface for connecting video devices to a TV set. This socket is also referred to as Scart socket.

**Exif:** Abbreviation for Exchangeable Image File Format. Standard format for additional data with modern digital cameras, e.g. date and time, aperture, light sensitivity, alignment of the camera (portrait/landscape).

## F

**FLOF:** Full Level One Facilities. Teletext system in which names and numbers of the jump destinations are transmitted in the bottom line on every page. This guides the reader to related topics for example. An information about which pages exist and which pages have sub-pages is not available in FLOF.

## G

**Gateway:** Transfer into another network; in this case connection from home network to internet.

The network device is usually used as the standard gateway which produces this connection. The DSL router generally also represents the internet gateway.

## H

**HbbTV:** HbbTV (Hybrid broadcast broadband television) is an industry standard that offers an open platform for technology that is not dependent on manufacturers. HbbTV combines TV programmes with online services seamlessly over broadband internet (DSL).

**HDCP:** High-bandwidth Digital Content Protection. Coding system provided for the **DVI** and **HDMI** interfaces for secure transmission of audio and video data.

**HDMI:** High Definition Multimedia Interface is a newly developed interface for full digital transmission of audio and video data.

**HDTV:** High Definition Television is an umbrella term that covers a number of high resolution television standards.

**HD-Ready:** A quality seal that is awarded to products that are capable of displaying high-definition television (**HDTV**).

**High band and Low band:** Transmission ranges for satellites.

**Host:** Computer that the server services are provided from, i.e. that makes data available. Refer also to media server.

# Glossary

## I

**ID3 tags:** Additional information for MP3 and WMA audio files. Information about the singer, title, album and album cover can be saved here among other things. These data are edited on the PC by an ID3 tag editor.

**IP address:** IP addresses (Internet Protocol Addresses) are used to identify devices in an Internet Protocol (IP) network. IP addresses are made up of four groups of numbers of three digits each.

**IR-Link:** The IR-Link function allows the operation of accessory devices with concealed installation made by other manufacturers via the Loewe TV set. The infrared sensor required for this is available as an accessory and can be connected to the IR-Link connection of the TV set.

## J

**JPEG/JPG:** Joint Photographic Experts Group is a committee which has developed a standard method for the compression of digital photos. This method JPEG (**JPG** for short), named after the committee, is a commonly used graphic format for photos.

## L

**LAN:** Abbreviation for Local Area Network. Mainly used as a designation for networks with wiring (Ethernet).

**LCD:** Liquid Crystal Display.

**LCN:** Logical Channel Numbers. In stations with LCN, the channel location number belonging to the station is also transmitted by the provider. The stations are sorted according to these channel location numbers.

**L-Link:** Intelligent system connection between Loewe devices for the automatic exchange of information. Makes the operation of TV and Loewe system components even more convenient.

**LNB/LNC:** The crucial electronic component of a satellite antenna is referred to as an LNB (Low Noise Block Converter). It is mounted in the focal point of a parabolic antenna. The designation **LNC** (Low Noise Converter) indicates that conversion to lower intermediate frequency takes place. The supplemental block in the LNB refers to the fact that a whole frequency range (a block) is converted in each case.

## M

**MAC address:** Hardware address of a network adapter, e.g. the network card in the PC. It is permanently assigned by the manufacturer and is used to uniquely identify devices in networks.

**Mbit/sec:** Information about the transfer rate in networks in megabits, i.e. millions of characters per second. With WLAN the maximum speed is 11 (IEEE 802.11b), 54 (IEEE 802.11g) or 300 (IEEE 802.11n) Mbit/sec, in wired networks 10 Mbit/sec or 100 Mbit/sec (Fast Ethernet).

**Media server:** Stands for the device which multimedia contents are stored on, but is also the name for the service provided by the device that makes this data available to the network.

**MHEG-5:** Digital teletext standard of the Multimedia and Hypermedia Expert Group. At the moment only available in United Kingdom and Ireland.

**Modulator:** Transmitter in the video or DVD recorder so that the devices can receive signals via the tuner of the TV device.

**Mono:** Single-channel audio.

**MPEG:** Digital compression process for video.

**MP3:** Data format for compressed audio files.

**Multimedia contents:** Videos, music files and photos are grouped together under this term.

## N

**NAS:** Abbreviation for Network Attached Storage. The term describes a hard disc which is independently linked to the network (i.e. without a PC).

**Network ID:** NID refers to the so-called programme ID number, also known as network ID – a number between 0 and 8191. This specification is necessary in specific cable networks of some countries. Then only DVB signals of this station network are searched for.

**NICAM:** Audio standard. Is used in Denmark, England, France, Sweden, and Spain.

**NTSC:** American colour standard.

## P

**Page Catching:** For teletext, refers to going to and calling a page number.

**PAL:** European standard.

**PCM:** Pulse Code Modulation for digital sound.

**Picture in Picture:** See **PIP**.

**PIP:** Picture in Picture; a function which displays two pictures on the screen.

**Pixel:** Denotes both the smallest unit of a digital graphic grid and its display on a screen with grid control.

**Pixel error:** A pixel error is a defective pixel, usually on an LCD. Pixel errors may be caused by production errors. They are expressed for example by a constantly lit pixel or a constantly black pixel. Single defective pixels however are excluded from a guarantee.

**PNG:** Abbreviation for Portable Network Graphics, a freely available grid graphics format for loss-free compression.

**Port:** A port is part of a network address (or also IP address). It allows assignment of data packages to various services which are running on one device under the same network address.

**Powerline:** Powerline refers to a type of wired network connection in which data can be transmitted via the domestic power supply using the optionally available adapters.

**Progressive JPEG:** Progressive **JPEGs** are built up gradually. The quality of the picture increases progressively during the loading process.



# Glossary

**ProScan/Progressive Scan:** Progressive Scan (abbr. PS) or full picture method is a technique in the picture build-up of monitors, TV sets, beamers, and other display devices in which the output device is not sent line interlaced half pictures – unlike in the interlace technique – but real full pictures.

**PSK:** Stands in connection with WLAN encoding for Pre-Shared Key. Clients, who want to connect up to a wireless network secured with PSK have to know this key.

## R

**RGB:** Colour signals red, green and blue.

**Router:** Device for connecting up several networks, e.g. home network and internet.

## S

**Satellite tuner:** Receiver for satellite programmes.

**SDTV:** Standard Definition TeleVision.

**SECAM:** French colour standard.

**Set-Top-Box:** Set-Top-Box (STB for short) refers to a device in entertainment electronics which is connected to another device, usually a TV set, and offers the user additional functional options.

**Signal input groups:** Depending on the applied signal, the signal sources are divided into different groups. All signal input groups with their corresponding signal types and the possible inputs are listed below.

### TV analogue:

Signal type: FBAS, YC, RGB-SD (480i/576i), Component-SD (480i/576i)  
Input: Tuner analogue, AV, AVS

### TV digital:

Signal type: DVB-SD, HDMI-SD (480i/576i)  
Input: Tuner digital, HDMI1, HDMI2

### HD analogue:

Signal type: RGB-HD (video mode: e.g. 1920x1080, 1280x720),  
Component-HD (video modes: e.g. 1920x1080, 1280x720)  
Input: PC IN

### HD digital:

Signal type: DVB-HD, HDMI-HD  
Input: Tuner digital, HDMI1, HDMI2

### PC:

Signal type: RGB  
(PC modes: e.g. 800x600, 1024x768, 1280x1024, 1360x768)  
Input: PC IN

### PhotoViewer:

Input: USB

**Signal strength:** Strength of the received antenna signal.

**Signal quality:** Quality of the incoming antenna signal.

**Smart Card:** The Smart Card is an electronic chip card issued by the respective programme provider or by the certification-free Pay-TV operators. It contains the code which is decoded by the **CA module**.

**Static contrast ratio:** Describes the difference between the brightest and darkest picture display.

**Stereo:** Dual-channel audio.

**Switch:** Device for connecting several computers to a network.

**Switch voltage:** Video devices specify this voltage to switch the TV device to playback.

**Symbol rate:** Describes the transmission speed for data transmission.

## T

**Terrestrial:** In data transmission a wireless transmission that does not use satellites as intermediate station is referred to as terrestrial.

**TFT:** Thin Film Transistor. One widely distributed application is control of liquid crystal flat screens, for which a signal transistor is used for each pixel. This design of display is also referred to as active matrix, however it is frequently also referred to as TFT display.

**TOP:** Table of Pages. Teletext system in which the individual pages are divided into topics. The blocks stand for a higher hierarchy level (e.g. News, Sport, Programmes) and the groups for the level below (e.g. Home/Abroad, Football/Tennis). Abbreviations can be assigned to the pages which are displayed in colour on the bottom line and can be selected with the four coloured buttons on the remote control. Information is also transmitted about which pages exist and which of them have sub-pages.

**Tuner:** Another term for receiver.

## U

**UPnP AV:** Abbreviation for Universal Plug and Play Audio / Video. Is used to control network devices from all manufacturers. Has become a wide spread standard for home networking.

**USB:** Universal Serial Bus. Serial bus system for connecting external devices (USB card reader, USB stick).

## V

**VGA:** PC interface for connecting a monitor.

**VPS:** The Video Programming System (VPS) is a signal which some (but not all) analogue TV stations transmit in the blanking gap. The signal is used by video and DVD recorders when recording programmes to react to delays in start time, programme changes and excesses of the planned programme time.

# Glossary

## W

**WEP:** Abbreviation for Wired Equivalent Privacy. Former standard process in the WLAN encryption, now outdated.

**Wired network:** see LAN.

**Wireless network:** see WLAN.

**WLAN:** Abbreviation for Wireless Local Area Network. Also referred to in brief as wireless network.

**WMA:** Abbreviation for Windows Media Audio, Microsoft's own audio data format. The contents are compressed as in MP3 files.

**WMV:** Abbreviation for Windows Media Video, Microsoft own video data format.

**WPA:** Abbreviation for Wi-Fi Protected Access. Replaced WEP as standard encryption for wireless networks.

## Y

**Ycc/Ypp:** Colour standards for **Set-Top-Boxes**.

**YCbCr:** Digital colour model, informally also incorrect designation for signals in standard resolution (**SDTV**). The YCbCr colour model, in which e.g. DVDs are coded, has been developed from the **YUV** colour model used in analogue television technology. With YCbCr, the data is transferred via digital interfaces such as **DVI** or **HDMI** without being converted.

**YPbPr:** Analogue colour model, see also **Component connection**. The analogue YPbPr signal is generated from the YCbCr signal by a converter in the source player and then output at the 3 component outputs of the source player.

**YUV:** The YUV colour model is used for analogue television in accordance with the standards **PAL** and **NTSC**. YUV is often informally referred to when **YPbPr** (for analogue connections/cables) or **YCbCr** (in digital applications) is actually meant. YUV only occurs in quadrature modulation during PAL or NTSC transfer and is not otherwise used.

# EC Declaration of Conformity

- BG** Този уред отговаря на основните изисквания и разширените съответни предпоставки **Директива 1999/5/ЕС**. Разрешено е използването му във всички държави от **ЕС**, и освен това в **Исландия, Норвегия и Швейцария**. Във **Франция и Италия** използването му е разрешено **само в затворени помещения**.
- CZ** Toto zařízení je v souladu se základními požadavky a ostatními odpovídajícími ustanoveními **Směrnice 1999/5/EG**. Může být používán ve všech zemích **EU** dodatečně také na **Islandu, v Norsku a ve Švýcarsku**. Ve **Francii a v Itálii** je použití přístroje dovolené **jenom v interiéru**.
- D** Dieses Gerät entspricht den grundlegenden Anforderungen und den weiteren entsprechenden Vorgaben der Richtlinie **1999/5/EG**. Es darf in allen Ländern der **EU** sowie zusätzlich in **Island, Norwegen** und der **Schweiz** betrieben werden. In **Frankreich** und **Italien** ist die Nutzung **nur in Innenräumen** zulässig.
- DK** Dette udstyr er i overensstemmelse med de væsentlige krav og andre relevante bestemmelser i **Direktiv 1999/5/EF**. Det må kun anvendes i **EU-landene** samt i **Island, Norge** og **Schweiz**. I **Frankrig** og **Italien** er det kun tilladt at anvende det **indendørs**.
- E** Este equipo cumple con los requisitos esenciales así como con otras disposiciones de la **Directiva 1999/5/CE**. Puede operar en todos los países de la **UE** y adicionalmente en **Islandia, Noruega y Suiza**. En **Francia e Italia**, su uso está permitido **únicamente en espacios interiores**.
- FIN** Tämä laite täyttää **direktiivin 1999/5/EY** olennaiset vaatimukset ja on siinä asetettujen muiden laitetta koskevien määräysten mukainen. Laitetta saa käyttää kaikissa **EU-maissa** sekä **Islannissa, Norjassa ja Sveitsissä**. **Ranskassa ja Italiassa** laitetta saa käyttää **vain sisätiloissa**.
- F** Cet appareil est conforme aux exigences essentielles et aux autres dispositions pertinentes de la **Directive 1999/5/EC**. L'utilisation est possible dans tous les pays de l'**UE**, en **Islande**, en **Norvège** et en **Suisse**. En **France** et en **Italie** l'utilisation est autorisée **uniquement dans des espaces fermés**.
- GB** This equipment is in compliance with the essential requirements and other relevant provisions of **Directive 1999/5/EC**. It may be operated in all countries in the **EU** and also in **Iceland, Norway** and **Switzerland**. In **France** and **Italy** it may only be used **indoors**.
- GR** Αυτός ο εξοπλισμός είναι σε συμμόρφωση με τις ουσιώδεις απαιτήσεις και άλλες σχετικές διατάξεις της **Οδηγίας 1999/5/ΕΚ**. Επιτρέπεται η λειτουργία της σε όλες τις χώρες της **ΕΕ**, καθώς και στην **Ισλανδία**, στην **Νορβηγία** και στην **Ελβετία**. Στην **Γαλλία** και στην **Ιταλία** επιτρέπεται η χρήση **μόνο σε εσωτερικούς χώρους**.
- I** Questo apparato é conforme ai requisiti essenziali ed agli altri principi sanciti dalla **Direttiva 1999/5/CE**. Può essere messo in funzione in tutti i paesi dell'**UE** e inoltre in **Islanda, Norvegia** e in **Svizzera**. In **Francia** e in **Italia** è consentito l'uso **solo in ambienti chiusi**.
- N** Dette utstyret er i samsvar med de grunnleggende krav og andre relevante bestemmelser i **EU-direktiv 1999/5/EF**. Det kan brukes i alle **EU-land** og dessuten i **Island, Norge** og **Sveits**. I **Frankrike** og **Italia** er **kun innendørs bruk** tillatt.
- NL** Dit apparaat voldoet aan de essentiële eisen en andere van toepassing zijnde bepalingen van de **Richtlijn 1999/5/EG**. Het gebruik is toegestaan in alle landen van de **EU** en ook in **IJsland, Noorwegen** en **Zweden**. In **Frankrijk** en **Italië** is het gebruik **slechts binnenshuis** toegestaan.
- P** Este aparelho está em conformidade com os requisitos fundamentais e todas as restantes disposições da **Directiva 1999/5/CE**. Pode ser utilizado em todos os países da **UE** assim como na **Islândia, Noruega e Suíça**. Em **França e Itália** a sua utilização apenas é permitida em espaços interiores.
- S** Denna utrustning är i överensstämmelse med de väsentliga kraven och andra relevanta bestämmelser i **Direktiv 1999/5/EC**. Apparaten får användas i alla länder inom **EU** liksom på **Island, i Norge** och i **Schweiz**. I **Frankrike** och **Italien** får apparaten användas **endast inomhus**.



# EC Declaration of Conformity

## EG-Konformitätserklärung EC Conformity Declaration

Dokument-Nr./Monat . Jahr: **34395 / 09.2011**  
Document No./Month . Year

Hersteller: **Loewe Opta GmbH**  
Manufacturer

Handelsname: **LOEWE**  
Trade mark

Herstelleradresse: **Industriestrasse 11**  
Adress of manufacturer: **96317 Kronach**  
**Germany**

Produkt: **WLAN USB-Stick**  
Product

Produktbezeichnung : **WLAN STICK**  
Product designation:

Das bezeichnete Produkt stimmt mit den Vorschriften folgender Europäischer Richtlinien überein:  
The designated product conforms to the provisions of the following European directives:

### 1999/5/EG

Richtlinie des Rates vom 9. März 1999 über Funkanlagen und Telekommunikationsendeinrichtungen und die gegenseitige Anerkennung ihrer Konformität  
Radio equipment and Telecommunications Terminal Equipment and the Mutual Recognition of their Conformity

Anbringung der CE-Kennzeichnung: **11**  
Affixing of the CE marking



Die Übereinstimmung des bezeichneten Produkts mit den Vorschriften der Richtlinien wird nachgewiesen durch die vollständige Einhaltung folgender Normen:

The conformity of the designated product with the provisions of Directives is proved by full compliance with the following standards:

### Richtlinie / Directive 1999/5/EG

<input checked="" type="checkbox"/>	EN 60950-1	2006	A11 : 2009
<input checked="" type="checkbox"/>	EN 55022	2006	A1 : 2007
<input checked="" type="checkbox"/>	EN 301489-1	V1.8.1	2008-04
<input checked="" type="checkbox"/>	EN 301893	V1.5.1	2008-12

<input checked="" type="checkbox"/>	EN 301489-17	V2.1.1	2009-05
<input checked="" type="checkbox"/>	EN 300328	V1.7.1	2006-10
<input checked="" type="checkbox"/>	EN 62311	2008	
<input type="checkbox"/>			

Aussteller: **Loewe Opta GmbH**  
Issuer

Ort, Datum: **Kronach, den 14.09.2011**  
Place, Date

Rechtsverbindliche Unterschrift:  
Legally binding signature

  
Name: **ppa. Roland Eibl**  
Director R & D Product Development

  
Name: **V. Reiner Nowitzki**  
Head of TV Device Development

# Index

- 0-9**
  - 24p format .....89
- A**
  - Access code .....52
  - Active loudspeakers .....92
  - Adjusting the picture.....35
  - Adjusting the sound.....33
  - Alarm .....53
  - Allow switching voltage.....86
  - Antenna DVB .....86
  - Archive playback .....80
  - Audio adjustment .....33
  - AUDIO button..... 21, 95
  - Audio mode.....40
  - Auto dimming.....35
  - Auto format.....35
  - Automatic shutdown .....8
  - AV audio signal.....34
- B**
  - Balance.....34
  - Batteries .....20
  - Blu-ray player.....89
  - Brightness.....35
  - Button functions .....37
- C**
  - Call Digital Recorder menu .....72
  - Camcorder.....87
  - CA module .....55
  - Change favourites lists .....44
    - Add station .....44
    - Delete station.....44
    - Move station.....44
    - Rename list .....44
  - Change station .....43
    - Delete station.....43
    - Move station.....43
    - Rename station .....43
    - Restore station .....43
  - Changing the title of a recording.....82
  - Character Table.....98
  - CI slot.....55
  - Cleaning and care.....9
  - Code number.....52
  - Coloured buttons..... 37, 47
  - Colour intensity.....35
  - Colour temperature.....35
- Common Interface Plus**..... 84, 85
- Connecting antennas**.....18
- Connecting the TV Set**.....18
- Connections** .....11
- Contrast**.....35
- Control unit** .....10
- D**
  - Deleting
    - Recording.....81
  - Deleting timer entries.....77
  - Digital camera.....87
  - Digital Noise Control.....35
  - Direct recording.....73
  - Display.....21
  - DR+ Streaming.....83
    - Play via network .....83
  - DVB character ser .....40
  - DVB character set .....40
  - DVD button .....95
  - DVD player .....89
  - DVD recorder.....89
  - DVI/HDMI .....89
- E**
  - Encrypted stations..... 23, 24, 28, 41, 55
  - Energy efficiency..... 15, 22
  - Environmental protection.....108
  - EPG .....45
- F**
  - Factory settings picture/sound.....36
  - Fast forward and rewind..... 79, 81
  - Favourites .....32
  - Film quality improvement (DMM).....35
  - First installation wizard.....22
  - FLOF .....47
  - Format storage media .....84
- G**
  - Game console.....89
- H**
  - HbbTV .....68
  - HDMI.....89
  - Headphone volume.....33
  - Help.....15
  - HiFi/AV amplifier ..... 91, 94
- I**
  - Image enhancement .....35
  - Index in the TV set .....15
  - Info display .....15
  - Installing the TV set.....18
- J**
  - Jump distance.....72
  - Jumping..... 78, 81
- L**
  - Language..... 22, 53, 99
  - Language/sound .....40
  - Last station .....37
  - Live picture .....78
  - LNC/LNB ..... 25, 26, 27
  - Logical Channel Number.....28
  - Loudness .....33
- M**
  - Mains switch..... 10, 21
  - Manual station search.....42
  - Maximum volume .....34
  - Max. switch on volume .....34
  - Media
    - Access.....57
    - Overview.....57
    - Quit .....57
  - MediaHome.....61
  - Media menu .....57
  - MediaMusic.....64
  - MediaPhoto .....65
    - Full-screen mode .....65
    - Rotate picture .....65
    - Slide show.....65
  - MediaPortal .....14
  - MediaText.....68
  - MediaUpdate.....56
  - MediaVideo .....66
    - Change size.....67
    - Jumping .....67
    - Playback.....66
    - Select language/sound .....67
    - Subtitles .....67
    - Subtitle time correction .....67
    - Wind.....67

# Index

- Memorise .....45
- Menu language .....15
- Menu operation.....12
- Mobile phone keypad .....12
- Move picture vertically .....36
- Muting .....33
  
- N**
- Numeric buttons ..... 12, 15, 31
  
- O**
- On/off button .....21
- On/Off button.....10
- On-screen displays .....54
- OPC.....35
- Overview diagram.....16
  
- P**
- Page selection.....47
- Parental lock .....52
- PC IN .....90
- Picture .....35
- Picture adjustment ..... 35, 36
- Picture format..... 35, 36
  - PALplus .....36
  - Panorama .....36
  - Zoom .....36
- PIN .....52
- Programme info.....37
  
- R**
- Radio menu ..... 17, 49
- Radio mode ..... 21, 48, 50
- REC button .....95
- Remote control ..... 3, 20, 95
- Repeat initial installation .....22
- Repeat playback.....81
- Reset picture/sound .....36
  
- S**
- Safety .....8, 9
- Scope of delivery.....7
- Search wizard .....41
- Selecting audio/video source.....32
- Select satellite installation.....24
- Select station .....31
  - via favourites lists .....32
  - with P+/P- .....31
  - with the numeric buttons .....31
  - with the station list.....31
- Service .....119
- Set covers .....18
- Setting pre-record time and post-record time .....73
- Set-Top-Box .....89
- Sharpness .....35
- Signal type.....86
- Smart Card.....55
- Smart Jump..... 72, 78, 81
- Software download .....96
- Software update .....96
- Sound .....33
- Sound adjustment.....33
- Sound components wizard.....91
- Sound effects.....33
- Sound off .....33
- Sound-picture synchronisation .....33
- Sound via.....33
- Standby mode .....21
- Station list.....31
- Station search/update .....41
- Status display ..... 39, 74
- Stop recording early .....74
- Subtitles..... 37, 40
- Subwoofer.....92
- Switching off .....21
- Switching off the TV set during recording..74
- Switching on.....21
- Switch on TV when marked .....46
- Switch to live picture.....78
  
- T**
- Teletext.....47
- Time .....38
- Time and date.....54
- Timer data .....76
  - Date .....76
  - Lock movie.....76
  - Programme provider PIN.....76
  - Recording time .....76
  - Recording type .....76
  - Record subtitles.....76
  - Station .....76
- Timer functions.....53
- Timer overview ..... 75, 77
- Timer recording.....75
  - manually .....76
  - via EPG.....75
- TOP .....47
- TV button ..... 20, 95
- TV menu.....16
- TV set equipment.....106
- TV viewing with time shift.....78
  
- U**
- UPnP.....56
- USB stick.....96
  
- V**
- Viewing a locked movie .....82
- Viewing another movie from the archive during archive recording .....74
- Volume .....33
  
- W**
- Wired connection .....56
- Wireless radio connection .....56

# Service

**A** Loewe Austria GmbH  
Parking 12  
1010 Wien, Österreich  
Tel +43 - 810 0810 24  
Fax +43 - 1 22 88 633 - 90  
E-mail: loewe@loewe.co.at

**AUS**  
Audio Products Group Pty Ltd  
67 O'Riordan St  
Alexandria NSW 2015, Australia  
Tel +61 - 1300 130 492  
Fax +61 - 02 9578 0140  
E-mail: help@audioproducts.com.au

**B NL L**  
Loewe Opta Benelux NV/SA  
Uilenbaan 84  
2160 Wommelgem, België  
Tel +32 - 3 - 2 70 99 30  
Fax +32 - 3 - 2 71 01 08  
E-mail: ccc@loewe.be

**BG** Darlington Service  
193 Kn. Klementina St.  
1612 Sofia, Bulgaria  
Tel +359 - 2 9556399  
E-mail: darlington@psp-bg.com

**CH** Telion AG  
Rütistrasse 26  
8952 Schlieren, Schweiz  
Tel +41 - 44 732 15 11  
Fax +41 - 44 732 15 02  
E-mail: infoKD@telion.ch

**CY** Hadjikyriakos & Sons Ltd.  
121 Prodomos Str., P.O Box 21587  
1511 Nicosia, Cyprus  
Tel +357 - 22 87 21 11  
Fax +357 - 22 66 33 91  
E-mail: sawvas@hadjikyriakos.com.cy

**CZ** BaSys CS s.r.o.  
Sodomkova 1478/8  
10200 Praha 10 - Hostivar,  
Česká republika  
Tel +420 234 706 700  
Fax +420 234 706 701  
E-mail: office@basys.cz

**D** Loewe Opta GmbH,  
Customer Care Center  
Industriestraße 11  
96317 Kronach, Deutschland  
Tel +49 180122256393  
Fax +49 926199500  
E-mail: ccc@loewe.de

**DK** Kjaerulff 1 Development A/S  
C.F. Tietgens Boulevard 19  
5220 Odense SØ, Denmark  
Tel +45 - 66 13 54 80  
Fax +45 - 66 13 54 10  
E-mail: info@loewe.dk

**E** Gaplasa S.A.  
Conde de Torroja, 25  
28022 Madrid, España  
Tel +34 - 917 48 29 60  
Fax +34 - 913 29 16 75  
E-mail: loewe@maygap.com

**EST** Tedra Trading Oy  
Kuusemetsa 3  
Saaue 76506, Estonia  
Tel +372 - 50 14 817  
Fax +372 - 67 09 611  
E-mail: info@futurehifi.com

**F** Loewe France SAS  
Rue du Dépôt,  
13 Parc de l'Europe, BP 10010  
67014 Strasbourg Cédex, France  
Tel +33 - 3 - 88 79 72 50  
Fax +33 - 3 - 88 79 72 59  
E-mail: loewe.france@loewe-fr.com

**FIN** Karevox Oy  
Museokatu 36  
00100 Helsinki, Finland  
Tel +358 - 9 44 56 33  
E-mail: kare@haloradio.fi

**GB IRL** Loewe UK Limited  
1st Floor, 237A Kensington High St  
London  
W8 6SA, UK  
Tel +44 - (0) 207 368 1100  
Fax +44 - (0) 207 368 1101  
E-mail: enquiries@loewe-uk.com

**GR** Issagogiki Emboriki Ellados S.A.  
321 Mesogion Av.  
152 31 Chalandri-Athens, Hellas  
Tel +30 - 210 672 12 00  
Fax +30 - 210 674 02 04  
E-mail: christina\_argyropoulou@isembel.gr

**H** Basys Magyarorszagi KFT  
Tó park u.9.  
2045 Törökbálint, Magyar  
Tel +36 - 2341 56 37 (121)  
Fax +36 - 23 41 51 82  
E-mail: ertekesites@basys.hu

**HK CN** Galerien Und PartnerPlus  
King's Tower 28/F, 111 King Lam Street  
Kowloon, Hong Kong  
Tel +852 - 27 77 89 88  
Fax +852 - 23 10 08 08  
E-mail: service@loewe-cn.com

**HR** Plug&Play Ltd.  
Bednjanska 8, 10000 Zagreb  
Hrvatska (Kroatia)  
Tel +385 1 4929 683  
Fax +385 1 4929 682  
E-mail: info@loewe.hr

**I** Loewe Italiana S.r.l.  
Largo del Perlar, 12  
37135 Verona (VR), Italia  
Tel +39 - 045 82 51 690  
Fax +39 - 045 82 51 622  
E-mail: info@loewe.it

**IL**  
Clear electronic entertainment Ltd  
13 Noah Mozes St.  
Agish Ravad Building  
Tel Aviv 67442, Israel  
Tel +972 - 3 - 6091100  
Fax +972 - 3 - 6092200  
E-mail: info@loewe.co.il

**KSA** Salem Agencies & Services Co.  
Hamad Al Haqueel Street, Rawdah,  
Jeddah 21413  
Kingdom of Saudi Arabia  
Tel +966 (2) 665 4616  
Fax +966 (2) 660 7864  
E-mail: hkurkjan@aol.com

**LT** A Cappella Ltd.  
Ausros Vartu 5, Pasazo skg.  
01129 Vilnius, Lithuania  
Tel +370 - 52 12 22 96  
Fax +370 - 52 62 66 81  
E-mail: info@loewe.lt

**LV** Loewe .service center  
Brivibas gatve 332,  
Riga, Latvia, LV-1006  
Tel +371 673 105 68  
E-mail: dom332@dom332.lv

**M** Doneo Co. Ltd  
34/36 Danny Cremona Street  
Hamrun, HMR1514, Malta  
Tel +356 - 21 - 22 53 81  
Fax +356 - 21 - 23 07 35  
E-mail: service@doneo.com.mt

**MA** Somara S.A.  
377, Rue Mustapha El Maani  
20000 Casablanca, Morocco  
Tel +212 - 22 22 03 08  
Fax +212 - 22 26 00 06  
E-mail: somara@somara.ma

**N** Premium Consumer Electronics as  
Østre Kullerød 5  
3241 Sandefjord, Norge  
Tel +47 - 33 29 30 40  
Fax +47 - 33 44 60 44  
E-mail: loewe@loewe.no

**NZ** Audio Products Group Pty Ltd  
67 O'Riordan St  
Alexandria NSW 2015, Australia  
Tel 0800 174 781  
Fax +61 - 02 9578 0140  
E-mail: help@audioproducts.com.au

**P** Mayro Magnetics Portugal, Lda.  
Rua Professor Henrique de Barros  
Edifício Sagres, 2º. C  
2685-338 Prior Velho, Portugal  
Tel +351 - 21 942 78 30  
Fax +351 - 21 940 00 78  
E-mail: geral.loewe@mayro.pt

**PL** Tele Radio Video  
Ul. Boh. Getta Warszawskiego 18  
81-609 Gdynia  
Tel. 58 624-50-09  
E-Mail: loewe@trv.com.pl

**RO** Avitech Co. SRL  
1/11 Pipera Tunari St.  
007190 Voluntari, Ilfov, Romania  
Tel +40 - 21 200 64 64  
Fax +40 - 21 200 64 65  
E-mail: gina.surghila@avitech.ro

**RUS** Service Center Loewe  
Aptekarsky per.4 podjezd 5A  
105005 Moscow, Russia  
Tel +7 - 499 940 42 32 (ext. 454)  
Fax +7 - 495 730 78 01  
E-mail: service@loewe-cis.ru

**S** Kjaerulff 1 AB  
Ridbanegatan 4, Box 9076  
200 39 Malmö, Sverige  
Tel +46 - 4 06 79 74 00  
Fax +46 - 4 06 79 74 01  
E-mail: loewe@loewe.se

**SG** Atlas Sound & Vision Pte Ltd  
10 Winstedt Road #01-18  
Singapore 227977  
Tel +65 - 6334 9320  
Fax +65 - 6339 1615  
E-mail: service@atlas-sv.com

**SL** JADRAN d.d., Sežana  
Partizanska cesta 69  
6210 Sežana, Slovenija  
Tel +386 57391200  
Fax +386 57391460  
E-mail: info@jadrans.si

**SK** BaSys SK, s.r.o.  
Stará Vajnorská 37/C  
83104 Bratislava, Slovakia  
Tel + 421 2 49 10 66 18  
Fax + 421 2 49 10 66 33  
E-mail: loewe@basys.sk

**TR** SERVISPLUS GENEL MERKEZ  
ÖRNEK MAH. ATES SOK. NO:1  
34704 ATASEHIR, ISTANBUL, TÜRKİYE  
Tel +90 - 216 315 39 00  
Fax +90 - 216 315 49 50  
E-mail: info@servisplus.com.tr

**UAE** Dubai Audio Center  
P.O. Box 32836, Sheikh Zayed Road  
Dubai, UAE  
Tel +971 - 4 343 14 41  
Fax +971 - 4 343 77 48  
E-mail: service@dubaiaudio.com

**ZA** The Soundlab (Pty) Ltd  
P.O. Box 31952, Kyalami 1684  
Gauteng, Republic of South Africa  
Tel +27 - 1 14 66 47 00  
Fax +27 - 1 14 66 42 85  
E-mail: loewe@mad.co.za







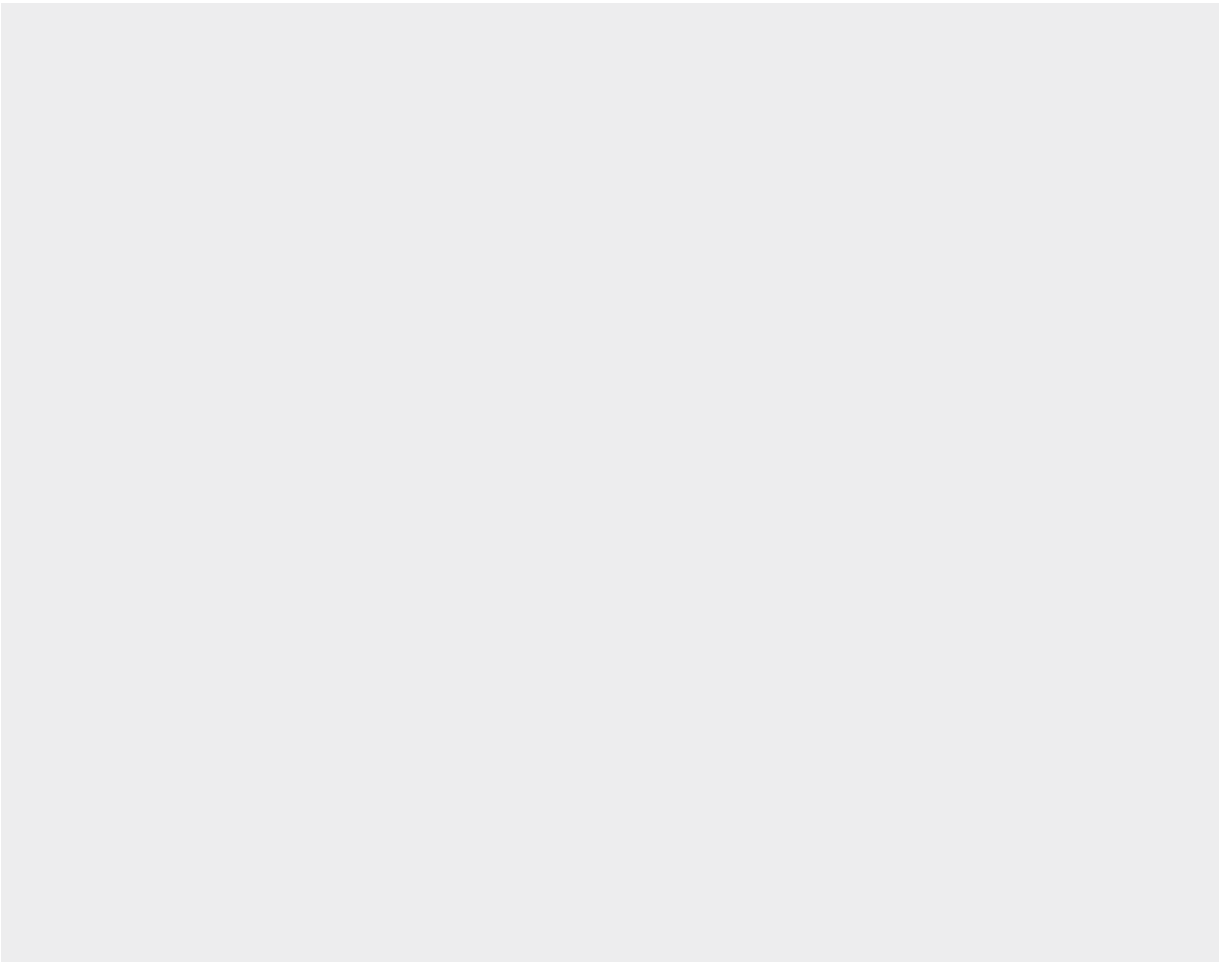

**LOEWE.**